

Dreame Pocket

High-Speed Hair Dryer
User Manual

DREAME

EN	User Manual	001
DE	Benutzerhandbuch.....	012
FR	Manuel d'utilisation.....	023
IT	Manuale dell'utente.....	034
ES	Manual de usuario.....	045
NL	Gebruikershandleiding.....	056
RU	Руководство пользователя.....	067
TH	คู่มือการใช้งาน.....	078
VI	Hướng dẫn sử dụng.....	089
ID	Panduan Pengguna.....	100
AR	دليل المستخدم.....	111
SV	Användarhandbok.....	122
NO	Brukerhåndbok	133
PL	Instrukcja obsługi.....	144
TR	Kullanım Kılavuzu.....	155
KO	사용 설명서.....	166

In the box

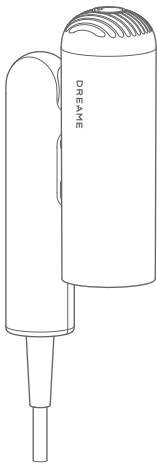

Dreame Pocket
High-Speed
Hair Dryer

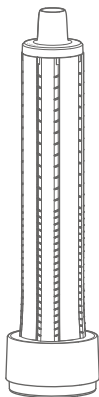

Curling Nozzle

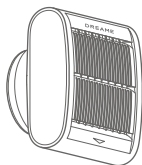

Unfrizz Nozzle

Some Nozzles may not be included. You can buy additional attachments at <https://global.dreametech.com>

Getting started

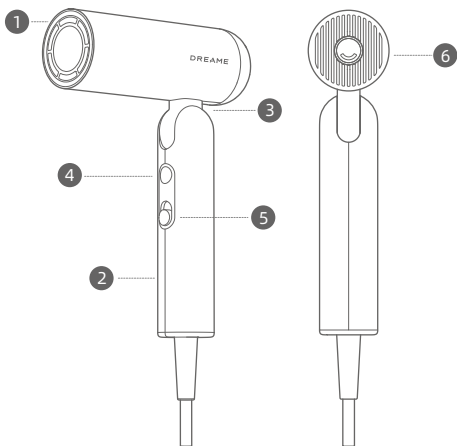

1 Air Outlet Vent

2 Handle

3 Shaft

4 Temperature settings/Airflow temperature indicator light

5 On/Off Switch & Speed Settings

6 Removable Airflow Filter

For safety reasons, do not use the hair dryer without the airflow filter.



These symbols mean "Do not use while bathing or showering."

Illustrations of the hair dryer, accessories, and user interface in the user manual are for reference purposes only. The actual product may vary due to product updates and improvements.

Settings

On/Off Switch & Speed Settings

Slide up and down to quickly switch between the two speed settings.

Make sure that the switch is turned off before plugging the hair dryer in.

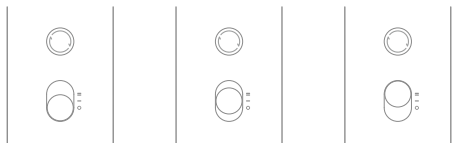

Off (O)

Low-speed (-)

High-speed (=)

Temperature Settings

Press to cycle through the four heat settings: cold air, warm air, hot air, and hot/cold cycle.

Press and hold to switch to coldair, the temperature will return to its previous state after letting go of the button.

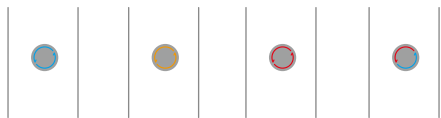

Cold air ()

Warm air ()

Hot air ()

Hot/Cold Cycle ()

Blows cold room temperature air suitable for hair styling.

Perfect temperature to avoid heat damage when blow drying your hair.

Suitable for quickly drying wet hair.

7s of hot air followed by 5s of cold air to reduce heat buildup.

Quickly Switch To The Cold Temperature

Press and hold the temperature button  to quickly switch to the cold temperature setting for styling. Release the temperature button to revert to the original temperature settings.

Hair Dryer Form

The Pocket can be switched between three forms for different styling scenarios.

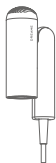

"N" form: Folded for convenient storage

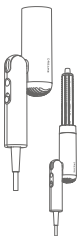

"1" form: Use the curling nozzle to create a curly style

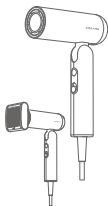

"7" form: Use the Unfrizz Nozzle while drying your hair to create a sleek, straight look

Nozzle Functions and Usage

The hair dryer comes with magnetic nozzles that are easy to install and remove. Simply line up the nozzle with the metal ring around the air outlet to snap it in place.

Create a Smooth and Straight Hairstyle

Use the Unfrizz Nozzle

The combination of three-stage acceleration and streamlined surfaces create a powerful suction air flow that straightens your hair and smooths flyaways. Use with a comb to add a natural curve.

Step 1

Dry your hair with the Dreame Pocket hairdryer.



Step 2

Attach the Unfrizz Nozzle, arrow indicates the direction of airflow, hold the nozzle close to your hair so that the strands are drawn to the nozzle, then slowly move the nozzle down until you reach the ends. Use on blow-dried hair to smooth flyaways.

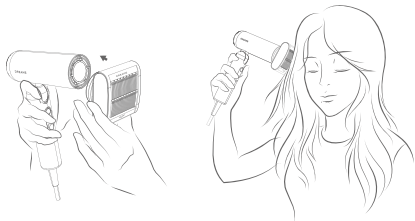

Create a Smooth and Straight Hairstyle

Step 3

When you are done using the nozzle, let it cool down before removing it by grasping both sides of the nozzle.

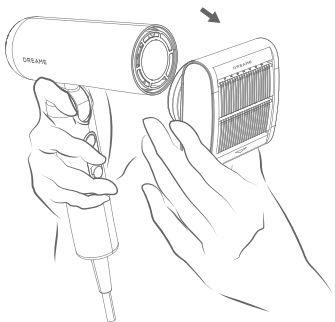

EN Create a Curly Hairstyle

Use the curling nozzle

The suction curling nozzle lets you blow dry and style at the same time, saving you time and preventing damage to the hair.

Step 1

Dry your hair with the Dreame Pocket hairdryer.



Step 2

Attach the curling nozzle, take a section of hair and hold the curler near the end of the hair. The hair will automatically wrap around the curler.



Create a Curly Hairstyle

Step 3

Hold the curler close to your head for 15 seconds.

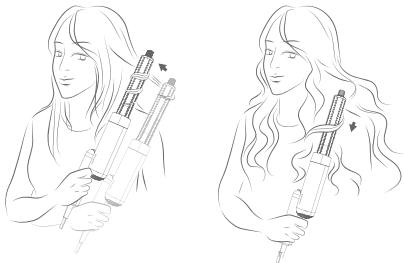

Step 4

Press and hold the mode button to enter cool mode and hold for 5-10 seconds to set the curl. Turn off the hairdryer to release your hair.

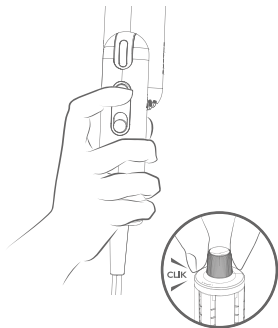

Rotate the insulated tip to change the curling direction.

Cleaning and Maintenance

The removable airflow filter is fixed in place by snaps. Turn in the direction indicated to remove.

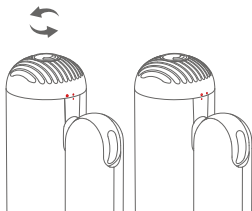

Rotating airflow filter

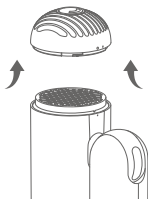

Remove the airflow filter

The metal filter needs to be cleaned regularly to prevent debris from building up and maintain a smooth flow of air.

Cleaning and Maintenance

Use a dry, lint-free cloth, soft brush or toothbrush to remove any debris stuck to the surface of the airflow filter or stainless steel filter.

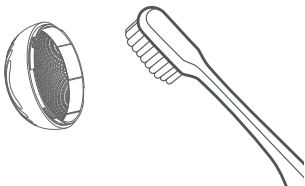

Cleaning airflow filter

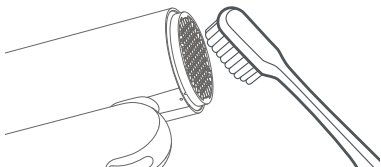

Cleaning Metal filter



Do not rinse the metal filter with water as this may prevent it from working properly.

After cleaning, reinstall the airflow filter, making sure it snaps firmly back into place.

EN Basic Parameters

Product name	Dreame Pocket High-Speed Hair Dryer
Model number	AHD51
Rated voltage	220-240 V~
Rated frequency	50/60 Hz
Rated power	1300 W
Product dimensions	50×145×201 mm

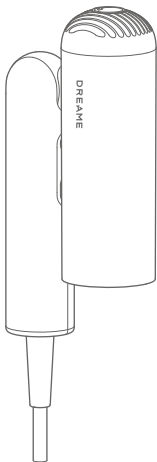

Dreame Pocket
High-Speed-
Haartrockner

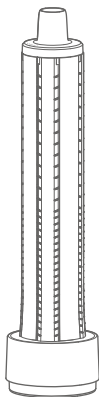

Locken-Düse

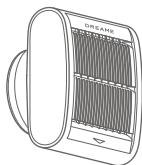

Anti-Frizz-Düse

Einige Düsen sind eventuell nicht im Lieferumfang enthalten. Zusätzliche Aufsätze können Sie unter <https://global.dreametech.com> erwerben.

DE Erste Schritte

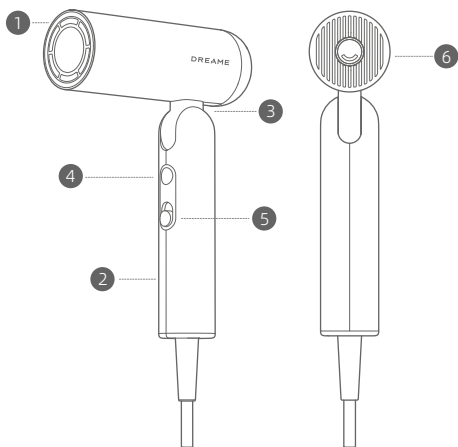

1 Luftaustrittsöffnung

2 Griff

3 Gelenk

4 Kontrollleuchte für
Temperatureinstellungen/
Luftstromtemperatur

5 Ein-/Aus-Schalter
und Geschwindigkeitseinstellungen

6 Abnehmbarer
Luftstromfilter
Verwenden Sie den Haartrockner
aus Sicherheitsgründen nicht ohne
den Luftstromfilter.



Diese Symbole bedeuten: „Nicht beim Baden oder Duschen verwenden“.

Die Abbildungen des Haartrockners, des Zubehörs und der Bedienoberfläche im Benutzerhandbuch dienen nur zu Referenzzwecken. Das tatsächliche Produkt kann aufgrund von Produktaktualisierungen und -verbesserungen anders aussehen.

Einstellungen

Ein-/Aus-Schalter und Geschwindigkeitseinstellungen

Bewegen Sie den Schieberegler nach oben und unten, um schnell zwischen den beiden Geschwindigkeitsstufen zu wechseln.

Der Schalter muss auf Aus stehen, bevor Sie den Netzstecker des Haartrockners einstecken.

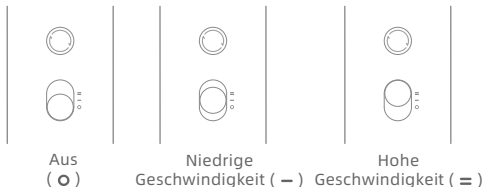

Temperatureinstellungen

Drücken Sie den Schalter, um zwischen den vier Heizstufen (Kühle Luft, Warme Luft, Heiße Luft und Warm-/Kaltluftzyklus) zu wechseln.

Halten Sie den Schalter gedrückt, um zu kühler Luft zu wechseln. Wenn Sie den Schalter loslassen, wechselt das Gerät wieder zur vorherigen Temperatur.

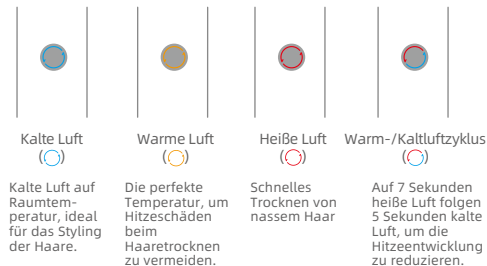

Schneller Wechsel zu kalter Luft

Halten Sie die Temperaturtaste  gedrückt, um schnell in den Stylingmodus mit kalter Luft zu wechseln. Lassen Sie die Temperaturtaste wieder los, um zur vorherigen Temperatureinstellung zurück zu wechseln.

Haartrockner-Form

Der „Pocket “ kann je nach gewünschtem Styling in drei verschiedenen Formen genutzt werden.

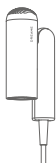

„N“-Form:
Zusammengeklappt für
praktische Aufbewahrung

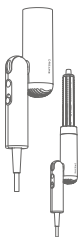

„1“-Form:
Locken-Düse für
lockige Styles

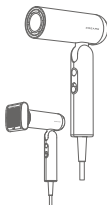

„7“-Form: Die Anti-Frizz-Düse
sorgt während des Föhnens für
geschmeidiges, glattes Haar

Funktionen und Verwendung der Düsen

Der Haartrockner verfügt über magnetische Düsen, die sich einfach befestigen und abnehmen lassen. Richten Sie einfach die Düse am Metallring um die Luftaustrittsöffnung aus, um sie sicher zu befestigen.

Für geschmeidige, glatte Styles

DE

Verwendung der Anti-Frizz-Düse

Die Kombination aus der dreistufigen Beschleunigung und den stromlinienförmigen Oberflächen erzeugt einen kraftvollen Luftstrom, der Ihr Haar glättet und fliegende Haare bündigt. Verwenden Sie sie zusammen mit einer Bürste, um Ihren Haaren einen natürlichen Schwung zu verleihen.

Schritt 1

Trocknen Sie Ihre Haare mit dem Dreame Pocket.



Schritt 2

Setzen Sie die Anti-Frizz-Düse auf. Der Pfeil zeigt dabei die Richtung des Luftstroms an. Halten Sie die Düse dicht an Ihr Haar, sodass die Haarsträhnen von der Düse angesogen werden. Bewegen Sie die Düse dann langsam nach unten bis zu den Haarspitzen.

Verwenden Sie die Düse bei trockenen Haaren, um fliegende Haare zu bündigen.



DE Für geschmeidige, glatte Styles

Schritt 3

Lassen Sie die Düse abkühlen, wenn Sie mit dem Styling fertig sind. Entfernen Sie sie dann, indem Sie beide Seiten der Düse greifen.

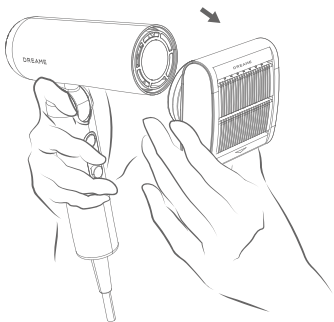

Für perfekte Locken

Verwendung der Locken-Düse

Mit der Locken-Düse können Sie Ihre Haare trocknen und gleichzeitig stylen. So sparen Sie Zeit und vermeiden Schäden an Ihren Haaren.

Schritt 1

Trocknen Sie Ihre Haare mit dem Dreame Pocket.



Schritt 2

Befestigen Sie die Locken-Düse, nehmen Sie eine Haarsträhne und halten Sie den Lockenstab an die Haarspitzen. Das Haar wickelt sich automatisch um den Lockenstab.

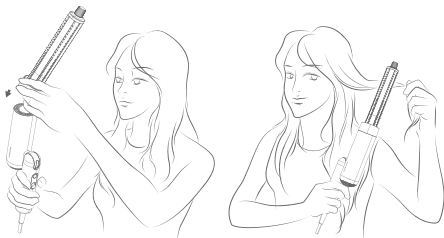

DE Für perfekte Locken

Schritt 3

Halten Sie den Lockenstab 15 Sekunden lang nah am Haaransatz.

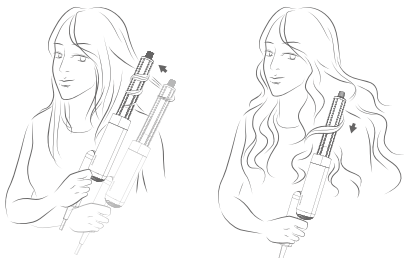

Schritt 4

Halten Sie die Modus-Taste gedrückt, um in den Modus für kühle Luft zu wechseln, und halten Sie sie dann 5-10 Sekunden lang gedrückt, um die Locke einzudrehen. Schalten Sie den Haartrockner aus, um Ihr Haar wieder zu lösen.

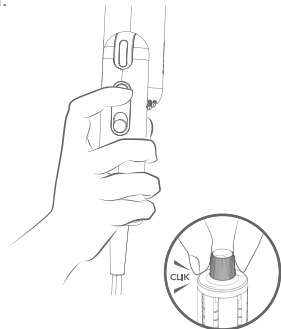

Drehen Sie die isolierte Spitze, um die Locken in die gewünschte Richtung einzudrehen.

Reinigung und Wartung

Der abnehmbare Luftstromfilter wird durch Einrasten befestigt. Drehen Sie zum Abnehmen in die angegebene Richtung.

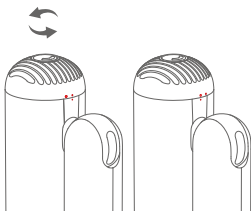

Luftstromfilter drehen

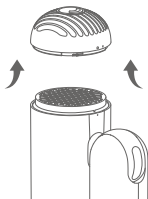

Entfernen Sie den Luftstromfilter

Der Metallfilter muss regelmäßig gereinigt werden, um starke Verschmutzungen zu verhindern und einen gleichmäßigen Luftstrom zu gewährleisten.

Reinigung und Wartung

Verwenden Sie ein trockenes, fusselfreies Tuch, eine weiche Bürste oder eine Zahnbürste, um Schmutz von der Oberfläche des Luftstromfilters oder des Edelstahlfilters zu entfernen.

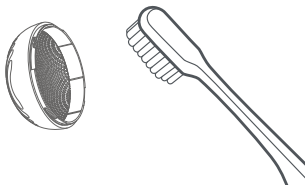

Reinigung des Luftstromfilters

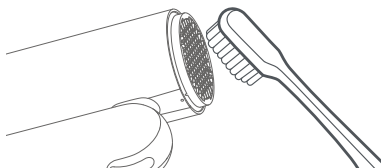

Reinigung des Metallfilters



Spülen Sie den Metallfilter nicht mit Wasser ab, da er dadurch möglicherweise nicht mehr ordnungsgemäß funktioniert.

Befestigen Sie den Luftstromfilter nach der Reinigung wieder und stellen Sie sicher, dass er fest einrastet.

Basisparameter

Produktname	Dreame Pocket High-Speed-Haartrockner
Modellnummer	AHD51
Nennspannung	220-240 V~
Nennfrequenz	50/60 Hz
Nennleistung	1300 W
Produkt- abmessungen	50 x 145 x 201 mm

FR Dans l'emballage

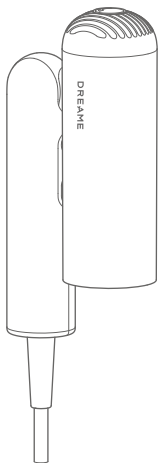

Sèche-cheveux
haute vitesse
Dreame Pocket

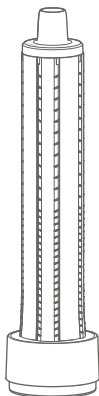

Buse de bouclage

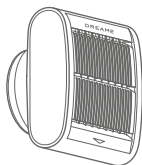

Buse de défrisage

Certaines buses peuvent ne pas être incluses. Vous pouvez acheter des accessoires supplémentaires sur <https://global.dreametech.com>

Mise en route

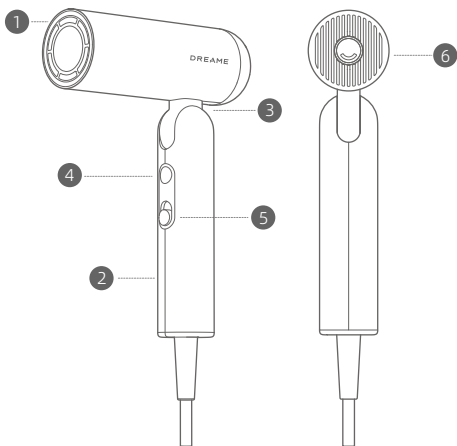

- 1 Orifice de sortie d'air
- 2 Poignée
- 3 Arbre
- 4 Voyant lumineux des réglages de température / de température de l'air
- 5 Bouton Marche/ Arrêt et réglages de la vitesse
- 6 Filtre à air amovible
Pour des raisons de sécurité, utilisez toujours le sèche-cheveux avec le filtre à air.



Ces symboles signifient « Ne pas utiliser dans un bain ou sous la douche ».

Les illustrations du sèche-cheveux, des accessoires et de l'interface utilisateur figurant dans le manuel d'utilisation ne sont fournies qu'à titre indicatif. Le produit réel peut varier en raison des mises à jour et des améliorations apportées à celui-ci.

Paramètres

Bouton Marche/Arrêt et réglages de la vitesse

Faites glisser le bouton vers le haut ou le bas pour passer rapidement d'un réglage de vitesse à l'autre.

Assurez-vous que le bouton est en position d'arrêt avant de brancher le sèche-cheveux.



Réglages de température

Appuyez pour faire défiler les quatre niveaux de température : air froid, air tiède, air chaud et cycle chaud/froid.

Appuyez longuement sur ce bouton pour passer à l'air froid.

La température revient à son état précédent une fois le bouton relâché.

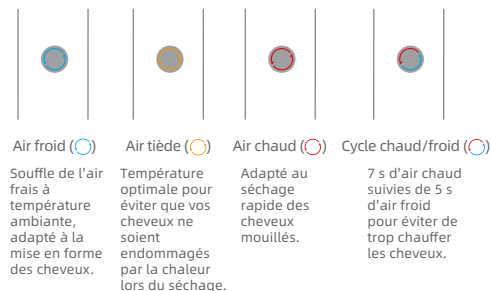

Passez rapidement à la température froide

Appuyez sur le bouton de température  et maintenez-le enfoncé pour passer rapidement au réglage de température à froid pour le coiffage. Relâchez le bouton de température pour revenir aux réglages de température d'origine.

Forme de sèche-cheveux

Le Pocket peut être avoir trois formes suivant les différents scénarios de coiffage.

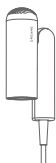

Forme « N » : plié pour un rangement pratique

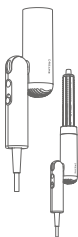

Forme « 1 » : utilisez l'embout de bouclage pour créer un style bouclé

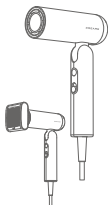

Forme « 7 » : utilisez l'embout de défrisage en séchant vos cheveux pour créer un look lisse

Fonctions et utilisation de la buse

Le sèche-cheveux est livré avec des buses magnétiques faciles à installer et à retirer. Alignez simplement la buse à l'anneau métallique autour de la sortie d'air pour l'enclencher.

Création d'une coiffure lisse

Utilisation de la buse de défrisage

La combinaison de l'accélération en trois étapes et des surfaces profilées crée un puissant flux d'air d'aspiration qui lisse vos cheveux et dompte les frisottis.

Utilisez un peigne pour ajouter une courbe naturelle.

Étape 1

Séchez vos cheveux avec le sèche-cheveux Dreame Pocket.



Étape 2

Fixez la buse de défrisage, de manière à ce que la flèche indique la direction du flux d'air, tenez la buse près de vos cheveux de sorte que les mèches soient attirées vers la buse, puis déplacez lentement celle-ci vers le bas jusqu'à atteindre les pointes. Utilisez sur les cheveux séchés pour lisser les frisottis.



Création d'une coiffure lisse

Étape 3

Lorsque vous avez fini d'utiliser la buse, laissez-la refroidir avant de l'enlever en saisissant les deux côtés de la buse.

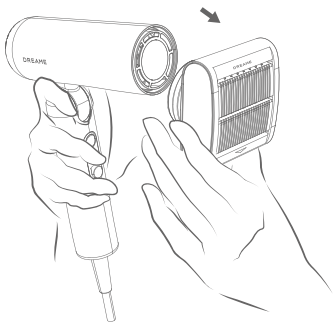

Création d'une coiffure bouclée

Utilisation de la buse de bouclage

La buse de bouclage par aspiration vous permet de sécher et de coiffer en même temps, ce qui vous fait gagner du temps et évite d'endommager les cheveux.

Étape 1

Séchez vos cheveux avec le sèche-cheveux Dreame Pocket.



Étape 2

Fixez la buse de bouclage, prenez une mèche de cheveux et tenez le fer près de la pointe des cheveux. Les cheveux s'enroulent automatiquement autour du fer.

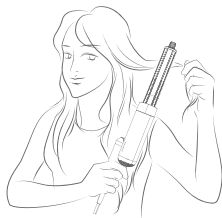

Création d'une coiffure bouclée

FR

Étape 3

Tenez le fer près de votre tête pendant 15 secondes.

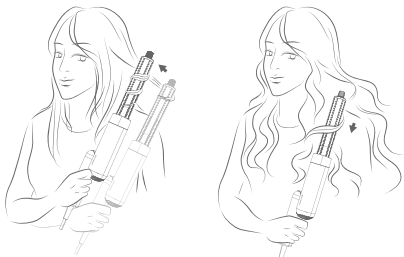

Étape 4

Appuyez sur le bouton Mode et maintenez-le enfoncé pour passer en mode froid et maintenez-le enfoncé pendant 5 à 10 secondes pour régler le bouclage. Éteignez le sèche-cheveux pour libérer vos cheveux.

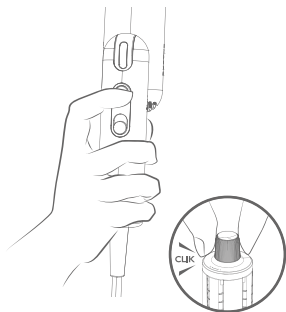

Faites tourner la pointe isolée pour changer la direction du bouclage.

Nettoyage et entretien

Le filtre à air amovible est fixé par des pressions. Tournez dans le sens indiqué pour l'enlever.

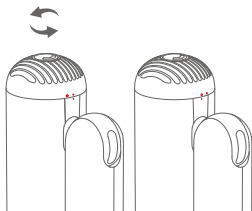

Rotation du filtre à air

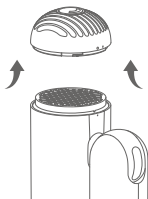

Retrait du filtre à air

Le filtre métallique doit être nettoyé régulièrement pour éviter que des débris ne s'accumulent et maintenir la fluidité de la circulation de l'air.

Nettoyage et entretien

Utilisez un chiffon sec non pelucheux, une brosse douce ou une brosse à dents pour enlever les débris collés à la surface du filtre à air ou du filtre en acier inoxydable.

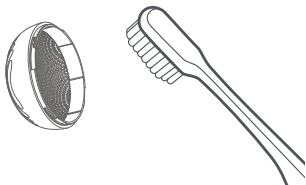

Nettoyage du filtre à air

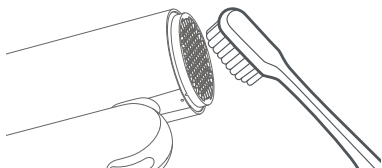

Nettoyage du filtre métallique



Ne rincez pas le filtre métallique avec de l'eau, car il risquerait de ne plus fonctionner correctement.

Après le nettoyage, réinstallez le filtre à air en vous assurant qu'il s'enclenche fermement.

Paramètres de base

Nom du produit	Sèche-cheveux haute vitesse Dreame
Numéro de modèle	AHD51
Tension nominale	220-240 V~
Fréquence nominale	50/60 Hz
Puissance nominale	1300 W
Dimensions du produit	50 x 145 x 201 mm

Contenuto della confezione

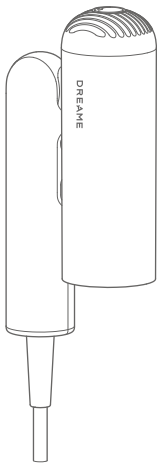

Asciugacapelli
ad alta velocità
Dreame Pocket

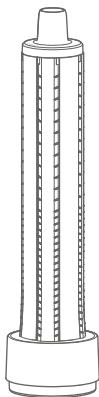

Bocchetta arricciacapelli

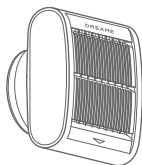

Bocchetta anticrespo

Alcune bocchette potrebbero non essere incluse. Puoi acquistare accessori aggiuntivi sul sito <https://global.dreametech.com>

Per iniziare

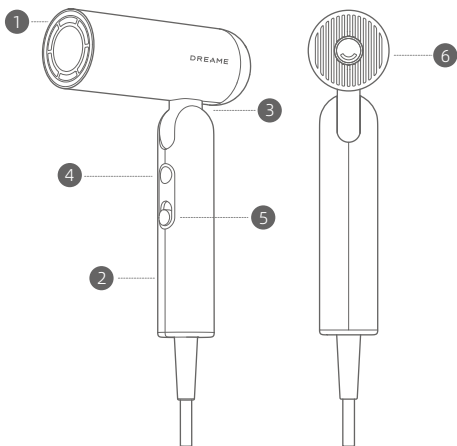

1 Bocchetta di uscita dell'aria

2 Impugnatura

3 Giunto

4 Spia impostazioni temperatura/temperatura flusso d'aria

5 Interruttore On/Off e impostazioni di velocità

6 Filtro del flusso d'aria rimovibile

Per motivi di sicurezza, non usare l'asciugacapelli senza il filtro del flusso d'aria.



Questi simboli indicano che non bisogna usare l'asciugacapelli durante il bagno o la doccia.

Le illustrazioni dell'asciugacapelli, degli accessori e dell'interfaccia utente nel manuale dell'utente sono fornite a solo scopo di riferimento. Il prodotto effettivo può variare a causa di aggiornamenti e miglioramenti del prodotto.

IT Impostazioni

Interruttore On/Off e impostazioni di velocità

Fai scorrere verso l'alto e verso il basso per passare rapidamente da una velocità all'altra.

Assicurati che l'interruttore sia in posizione Off prima di collegare l'asciugacapelli alla presa di corrente.

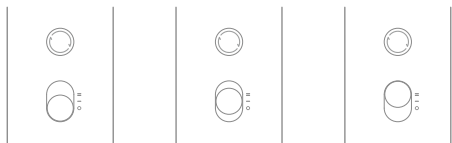

Off (●)

Bassa velocità (-)

Alta velocità (=)

Impostazioni di temperatura

Premi per scorrere tra le quattro impostazioni di calore: aria fredda, aria tiepida, aria calda e ciclo caldo/freddo.

Tieni premuto per passare all'aria fredda; una volta rilasciato il tasto, la temperatura torna allo stato precedente.

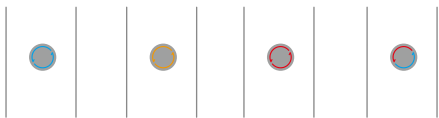

Aria fredda
(●)

Aria tiepida
(●)

Aria calda
(●)

Ciclo caldo/freddo
(●)

Emette aria fredda, perfetta per la piega.

Temperatura ideale per evitare danni ai capelli causati dal calore.

Ideale per asciugare rapidamente i capelli bagnati.

7 s di aria calda e 5 s di aria fredda per ridurre l'accumulo di calore.

Per passare rapidamente all'aria fredda

Tieni premuto il pulsante della temperatura ● per passare rapidamente all'impostazione della temperatura più bassa per la messa in piega.

Rilascia il pulsante della temperatura per tornare all'impostazione originale.

Configurazione dell'asciugacapelli

L'asciugacapelli Pocket può assumere tre configurazioni per utilizzi diversi.

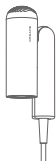

Configurazione a "N": piegato per riporlo facilmente.

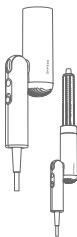

Configurazione a "1": usa la bocchetta arricciacapelli per mettere in piega i capelli

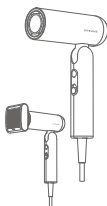

Configurazione a "7": usa la bocchetta anticrespo mentre asciughi i capelli per ottenere capelli perfettamente lisci

Funzioni e utilizzo delle bocchette

L'asciugacapelli è dotato di bocchette magnetiche facili da installare e da rimuovere. Basta allineare la bocchetta all'anello metallico intorno all'uscita dell'aria per farla scattare in posizione.

IT Per lisciare i capelli

Uso della bocchetta anticrespo

La combinazione di accelerazione a tre stadi e superfici ottimizzate crea una potente aspirazione in grado di lisciare i capelli, appiattendolo i capelli volanti. Usala con un pettine per creare una piega naturale.

Fase 1

Asciuga i capelli con l'asciugacapelli Dreame Pocket.



Fase 2

Collega la bocchetta anticrespo; la freccia indica la direzione del flusso d'aria. Tieni la bocchetta vicino ai capelli in modo che le ciocche vengano attratte verso la bocchetta, quindi sposta lentamente la bocchetta verso il basso fino a raggiungere le punte. Utilizzalo sui capelli già asciutti per lisciare i capelli volanti.

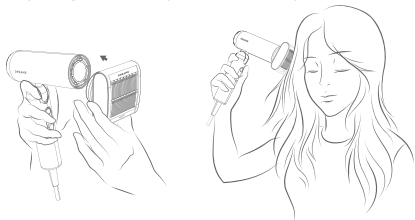

Per lisciare i capelli

Fase 3

Quando hai finito di utilizzare la bocchetta, lasciala raffreddare prima di rimuoverla afferrandola da entrambi i lati.

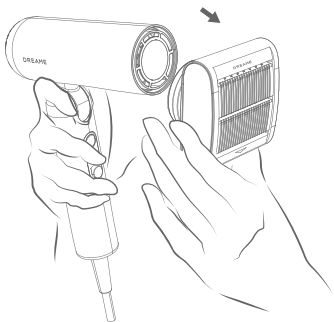

IT Per arricciare i capelli

Uso della bocchetta arricciacapelli

La bocchetta arricciacapelli aspirante consente di asciugare e mettere in piega allo stesso tempo, per risparmiare tempo ed evitare di danneggiare i capelli.

Fase 1

Asciuga i capelli con l'asciugacapelli Dreame Pocket.



Fase 2

Collega la bocchetta arricciacapelli, prendi una ciocca di capelli e tieni l'arricciacapelli vicino alle punte. I capelli si avvolgono automaticamente intorno all'arricciacapelli.

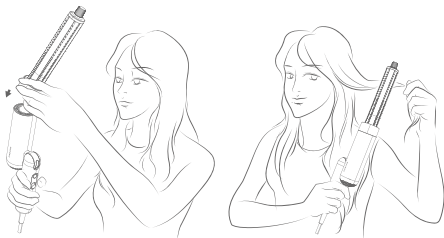

Per arricciare i capelli

Fase 3

Tieni l'arricciacapelli vicino alla testa per 15 secondi.

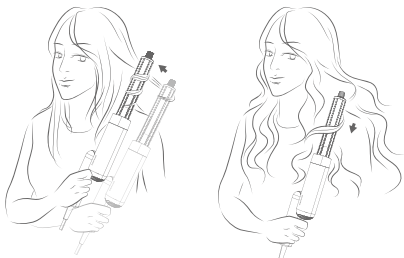

Fase 4

Tieni premuto il pulsante delle modalità per passare all'aria fredda e tieni l'arricciacapelli in posizione per 5-10 secondi per fissare la piega. Spegni l'asciugacapelli per rilasciare i capelli.

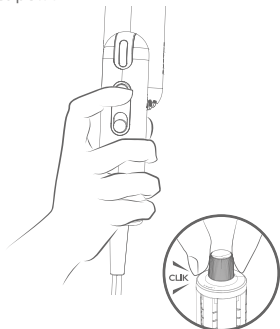

Ruota la punta isolata per cambiare la direzione di arricciatura.

Pulizia e manutenzione

Il filtro del flusso d'aria rimovibile è fissato in posizione mediante dei ganci. Ruotalo nella direzione indicata per rimuoverlo.

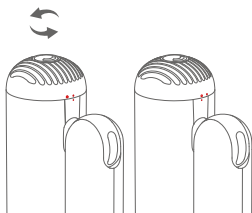

Ruotare il filtro del flusso d'aria

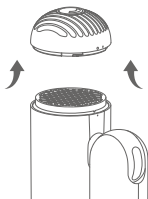

Rimuovere il filtro del flusso d'aria

Il filtro metallico deve essere pulito regolarmente per evitare l'accumulo di detriti e mantenere un flusso d'aria regolare.

Pulizia e manutenzione

Usa un panno asciutto privo di pelucchi, una spazzola morbida o uno spazzolino per rimuovere eventuali residui sulla superficie del filtro del flusso d'aria o del filtro in acciaio inox.

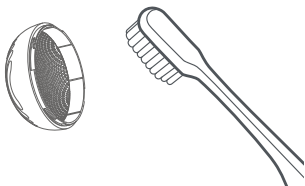

Pulire il filtro del flusso d'aria

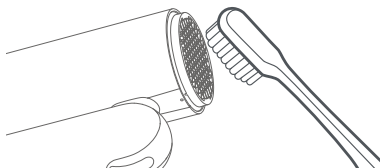

Pulire il filtro metallico



Non risciacquare il filtro metallico con acqua: ciò potrebbe causare malfunzionamenti.

Dopo la pulizia, reinstalla il filtro del flusso d'aria, assicurandoti che scatti in posizione.

IT Parametri di base

Nome del prodotto	Asciugacapelli ad alta velocità Dreame
Numero del modello	AHD51
Tensione nominale	220-240 V~
Frequenza nominale	50/60 Hz
Potenza nominale	1300 W
Dimensioni del prodotto	50×145×201 mm

Contenido de la caja

ES

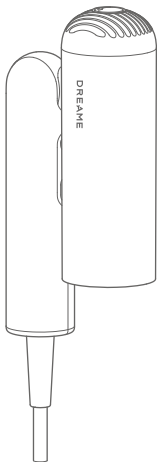

Secador de pelo
de alta velocidad
Dreame Pocket

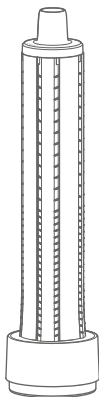

Boquilla de rizado

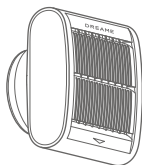

Boquilla antiencrespamiento

Es posible que algunas boquillas no estén incluidas. Puedes comprar accesorios adicionales en <https://global.dreametech.com>

ES Primeros pasos

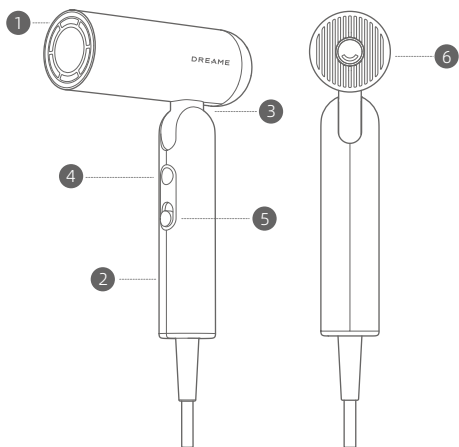

1 Salida de aire

2 Mango

3 Eje

4 Piloto indicador de ajustes de temperatura/ temperatura del flujo de aire

5 Interruptor de encendido/apagado y ajustes de velocidad

6 Filtro de aire extraíble

Por motivos de seguridad, no utilices el secador de pelo sin el filtro de aire.



Estos símbolos significan "No usar en la bañera o la ducha".

Las ilustraciones del secador de pelo, los accesorios y la interfaz de usuario del manual de usuario se incluyen únicamente a modo de referencia. El producto real puede variar debido a actualizaciones y mejoras.

Ajustes

Interruptor de encendido/apagado y ajustes de velocidad

Desliza hacia arriba y hacia abajo para cambiar rápidamente entre las dos velocidades.

Antes de enchufar el secador de pelo, asegúrate de que está apagado.



Ajustes de temperatura

Pulsa para alternar entre los cuatro ajustes de calor: aire frío, aire templado, aire caliente y ciclo caliente/frío.

Mantén pulsado para cambiar a aire frío; la temperatura volverá a su estado anterior al soltar el botón.



Genera aire frío a temperatura ambiente, perfecto para peinar el cabello.

La temperatura perfecta para evitar daños por calor al secar el pelo.

Perfecto para secar rápidamente el pelo húmedo.

7 s de aire caliente seguidos de 5 s de aire frío para reducir la acumulación de calor.

Cambiar rápidamente a la temperatura fría
Mantén pulsado el botón de temperatura (○) para cambiar rápidamente al ajuste de temperatura fría para peinar el pelo. Suelta el botón de temperatura para volver a los ajustes de temperatura originales.

Formas del secador de pelo

Puedes utilizar el Pocket de tres formas diferentes según la situación de peinado.

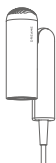

Forma de "N": plegado para un almacenamiento cómodo

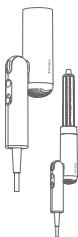

Forma de "1": utiliza la boquilla de rizado para crear un peinado rizado

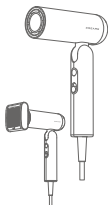

Forma de "7": utiliza la boquilla anti-crepamiento mientras secas tu pelo para crear un look liso y elegante.

Funciones y uso de la boquilla

El secador de pelo incluye boquillas magnéticas fáciles de instalar y quitar. Solo tienes que alinear la boquilla con el anillo metálico que se encuentra alrededor de la salida de aire para colocarla en su sitio.

Para alisar el pelo

Uso de la boquilla antiencrespamiento

La combinación de la aceleración en tres fases y las superficies optimizadas crea un potente flujo de aire de succión que alisa el cabello y peina el cabello rebelde. Utilízala con un peine-guía para añadir una curva natural.

Paso 1

Sécate el pelo con el secador Dreame Pocket.



Paso 2

Coloca la boquilla antiencrespamiento; la flecha indica la dirección del flujo de aire. Sostén la boquilla cerca del pelo de modo que los mechones se acerquen a ella y, a continuación, mueve lentamente la boquilla hacia abajo hasta llegar a las puntas. Utilízala sobre pelo seco con secador para peinar el cabello rebelde.

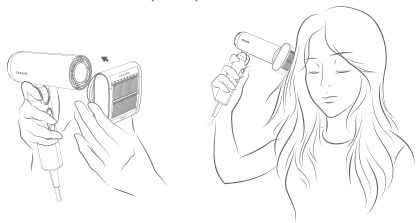

ES Para alisar el pelo

Paso 3

Cuando hayas terminado de utilizar la boquilla, deja que se enfríe antes de retirarla. Para retirarla, sujeta ambos lados de la boquilla.

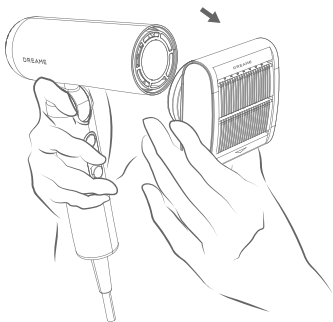

Para rizar el pelo

Uso de la boquilla de rizado

La boquilla de rizado con succión te permite secar y peinar el pelo al mismo tiempo, lo que te ahorra tiempo y evita dañar el cabello.

Paso 1

Sécate el pelo con el secador Dreame Pocket.



Paso 2

Acopla la boquilla de rizado, coge un mechón y sostén el rizador cerca de la punta del pelo. El pelo se enrollará automáticamente alrededor del rizador.

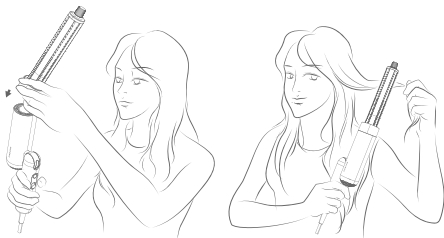

ES Para rizar el pelo

Paso 3

Mantén el rizador cerca de la cabeza durante 15 segundos.

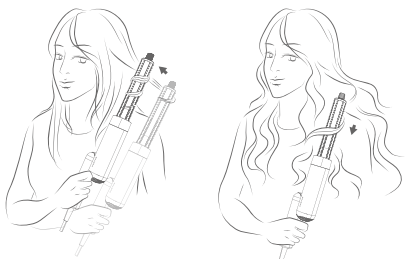

Paso 4

Mantén pulsado el botón de modo para acceder al modo de frío y mantenlo pulsado durante 5 o 10 segundos para fijar el rizo. Apaga el secador para liberar el pelo.

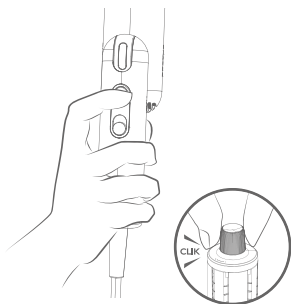

Gira la punta aislada para cambiar la dirección del rizado.

Limpieza y mantenimiento

El filtro de flujo de aire extraíble se fija mediante cierres a presión. Gíralo en la dirección indicada para retirarlo.

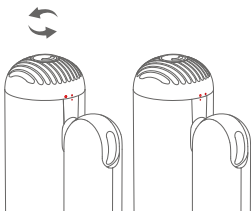

Girar el filtro de aire

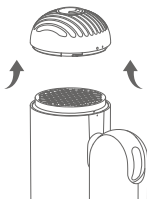

Retirar el filtro de aire

El filtro metálico debe limpiarse periódicamente para evitar que se acumulen residuos y mantener un flujo de aire adecuado.

Limpieza y mantenimiento

Utiliza un paño seco que no suelte pelusa, un cepillo suave o un cepillo de dientes para eliminar cualquier residuo que se haya adherido a la superficie del filtro de aire o del filtro de acero inoxidable.

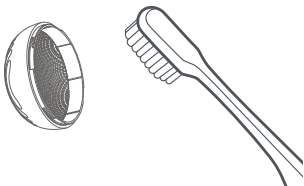

Limpiar el filtro de aire

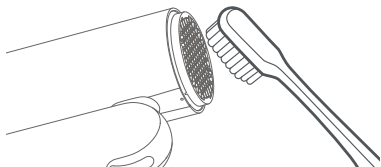

Limpiar el filtro metálico



No mojes el filtro metálico con agua, ya que podría impedir su correcto funcionamiento.

Después de limpiarlo, vuelve a instalar el filtro de aire y asegúrate de que encaja bien en su sitio.

Parámetros básicos

Nombre del producto	Secador de pelo de alta velocidad Dreame
Número de modelo	AHD51
Tensión nominal	220-240 V~
Frecuencia nominal	50/60 Hz
Potencia nominal	1300 W
Dimensiones del producto	50 x 145 x 201 mm

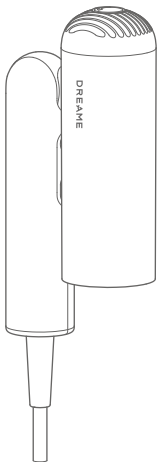

Dreame Pocket
High-Speed-föhn

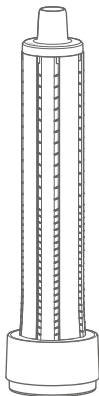

Krul-opzetstuk

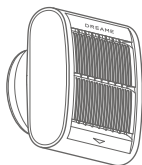

Anti-pluis opzetstuk

Sommige opzetstukken worden mogelijk niet meegeleverd. U kunt extra opzetstukken aanschaffen via <https://global.dreametech.com>

NL Aan de slag

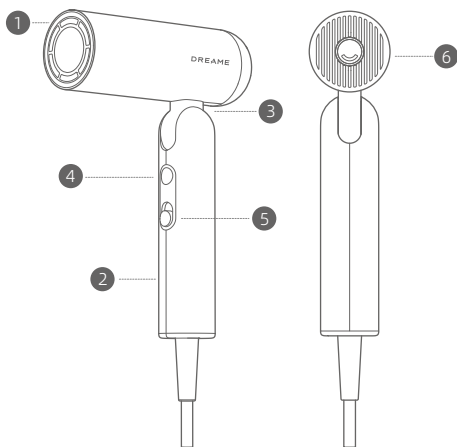

1 Luchtuitlaatopening

2 Handvat

3 Steel

4 Temperatuurinstellingen/indicatielampje luchtstroomtemperatuur

5 Aan/uit-schakelaar en snelheidsinstellingen

6 Verwijderbaar luchtstroomfilter

Gebruik voor de veiligheid de föhn niet zonder het luchtstroomfilter



Deze symbolen betekenen "Niet gebruiken tijdens baden of douchen".

Afbeeldingen van de föhn, accessoires en gebruikersinterface in de gebruikershandleiding dienen uitsluitend ter referentie. Het werkelijke product kan afwijken als gevolg van productupdates en verbeteringen.

Instellingen

Aan/uit-schakelaar en snelheidsinstellingen

Schuif omhoog en omlaag om snel tussen de twee standen te schakelen.

Zorg ervoor dat de schakelaar is uitgeschakeld voordat u de stekker van de föhn in het stopcontact steekt.

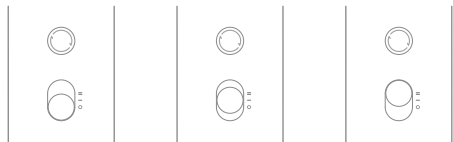

Uit (○)

Lage snelheid (–)

Hoge snelheid (=)

Temperatuurinstellingen

Druk hierop om door de vier warmte-instellingen te bladeren: koude lucht, warme lucht, hete lucht en de warme/koude cyclus.

Houd ingedrukt om over te schakelen naar koude lucht. De temperatuur keert terug naar de vorige stand nadat u de knop loslaat.

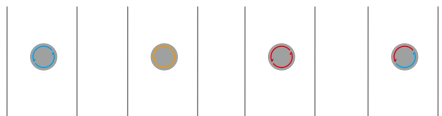

Koude lucht
(○)

Warme lucht
(○)

Hete lucht
(○)

Warme/koude cyclus
(○)

Blaast koude lucht op kamertemperatuur, geschikt voor het stylen van haar.

Perfekte temperatuur om hittebeschadiging te voorkomen bij het drogen van uw haar.

Geschikt voor het snel drogen van nat haar.

7 sec. hete lucht gevolgd door 5 sec. koude lucht om warmteontwikkeling te verminderen.

Schakel snel over naar de koude temperatuurstand

Houd de temperatuurknop  ingedrukt om snel over te schakelen naar de koude temperatuurstand voor het stylen. Laat de temperatuurknop los om terug te schakelen naar de oorspronkelijke temperatuurinstellingen.