

AEG

POWERTOOLS

LMG 50





- | | | | |
|-------|---|------------|--|
| click | ➔ | GB | Original instructions |
| click | ➔ | D | Originalbetriebsanleitung |
| click | ➔ | F | Notice originale |
| click | ➔ | I | Istruzioni originali |
| click | ➔ | E | Manual original |
| click | ➔ | P | Manual original |
| click | ➔ | NL | Oorspronkelijke gebruiksaanwijzing |
| click | ➔ | DK | Original brugsanvisning |
| click | ➔ | N | Original bruksanvisning |
| click | ➔ | S | Bruksanvisning i original |
| click | ➔ | FIN | Alkuperäiset ohjeet |
| click | ➔ | GR | Πρωτότυπο οδηγιών χρήσης |
| click | ➔ | TR | Orijinal işletme talimatı |
| click | ➔ | CZ | Původním návodem k používání |
| click | ➔ | SK | Pôvodný návod na použitie |
| click | ➔ | PL | Instrukcja oryginalna |
| click | ➔ | HU | Eredeti használati utasítás |
| click | ➔ | SLO | Izvirna navodila |
| click | ➔ | HR | Originalne pogonske upute |
| click | ➔ | LV | Instrukcijām oriģinālvalodā |
| click | ➔ | LT | Originali instrukcija |
| click | ➔ | EST | Algupärane kasutusjuhend |
| click | ➔ | RUS | Оригинальное руководство по эксплуатации |
| click | ➔ | BG | Оригинално ръководство за експлоатация |
| click | ➔ | RO | Instrucțiuni de folosire originale |
| click | ➔ | MK | Оригинален прирачник за работа |
| click | ➔ | PRC | 原始的指南 |

CONTENTS

Important safety instructions.....	1
Specified Conditions of Use	2
Error Code Table	2
Overview.....	3
Change batteries	4
Corner Pin	4
Belt Clip	4
Function Switch, Pythagoras, Measuring Reference.....	5
Single Distance Measuring.....	6
Permanent / Minimum-Maximum Measuring.....	7
Add / Subtract Measuring	8
Area Measuring	9
Volume Measuring.....	10
Indirect Measuring (Pythagoras 1)	11
Indirect Measuring (Pythagoras 2)	12
Indirect Measuring (Pythagoras 3)	13
Wall Area Measuring (Scenario 1).....	14
Wall Area Measuring (Scenario 2).....	15
Timer	16
Memory.....	16
Basic Description on example of Area measuring (1).....	17
Basic Description on example of Area measuring (2).....	18

IMPORTANT SAFETY INSTRUCTIONS

  Do not use the product before you have studied the Safety instructions and the User Manual.

Laser Classification

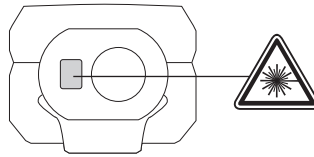

WARNING:
It is a Class 2 laser product in accordance with EN 60825-1:2007.



Labeling

We have supplied you with an adhesive label in your language and now request that you please apply this in place of the English text on the specification plate before first commissioning the machine.

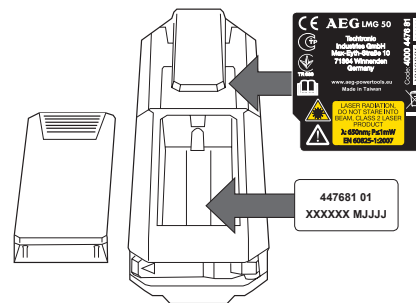

WARNING:
Avoid direct eye exposure. The laser beam can cause flash blindness.

Do not stare into the laser beam or direct it towards other people unnecessarily.

Don't dazzle other individuals.

WARNING:
Do not operate the tool around children or allow children to operate the tool.

The reflective surface could reflect the beam back at the operator or other persons.

Keep extremities in a safe distance from the moving parts. Carry out periodic test measurements. Particularly before, during and after important measurements.

Watch out for erroneous measurements if the product is defective or if it has been dropped or has been misused or modified.

WARNING: Use of controls, adjustments, or the performance of procedures other than those specified in the manual may result in hazardous radiation exposure.

The laser distance measurer has limits of use. (Refer to the "Technical data" section). Attempts to measure outside the maximum and minimum range will cause inaccuracy. Use in adverse conditions including too hot, too cold, very bright sunlight, rain, snow, fog, or other vision restricting conditions will result in inaccurate readings.

When the laser distance measurer is brought into a warm environment from very cold conditions, or vice versa, allow it to come to the surrounding temperature before use.

Always store the laser distance measurer indoors, avoid exposing the tool to shock, continuous vibration or extreme temperatures.

Always keep the tool away from dust, liquids and high humidity. These may damage internal components or affect accuracy.

Do not use aggressive cleaning agents or solutions. Use only a clean, soft cloth for cleaning.

Avoid heavy impact to or dropping of the measuring tool. The accuracy of the tool should be checked before use if it has been dropped or subjected to other mechanical stresses.

Any repair required on this laser product should be performed only by authorised service personnel.

Do not operate the product in explosion hazardous areas or in aggressive environments.

Only use chargers recommended by the manufacturer to charge the batteries.

 Flat batteries must not be disposed of with household waste. Care for the environment and take them to the collection points provided in accordance with national or local regulations. The product must not be disposed with household waste. Dispose of the product appropriately in accordance with the national regulations in force in your country. Adhere to the national and country specific regulations. Please contact your local authority or your dealer for how to dispose of batteries properly.

 European Conformity Mark

TECHNICAL DATA

Dust and Water resistance	IP54
Receiving Lens	14 mm
Focus	35 mm
Maximum Measuring Range	50 meters (Tolerance : 55m)
Minimum Measuring Range	0.05 meters
Absolute Accuracy @ < 10m	± 1.5 mm (Max)
Repeatability Accuracy @ < 10m	± 1.5 mm (Max Typical, 2σ)
Repeatability Accuracy @ > 10m	Increase ± 0.25 mm / meter (Max Typical, 2σ)
Measurement Time	0.5 s
Display Type	LCD (22.7 mm x 31 mm)
Power Type	AAA 2x (Alkaline Battery)
Battery Life	10000 (Single Measure)
Laser Output Power	0.6 mW ~ 0.95 mW (Class 2, 650nm)
Laser Spot Size	25 x 30 mm @ 16 m (Max)
Laser Radiation Vertical Angle	+1 degree
Laser Radiation Horizontal Angle	±1 degree
Device auto off time	180 seconds
Laser auto off time	30 seconds
Operating Temperature Range	-10°C to +50°C
Storage Temperature Range	-25°C to +70°C
Weight without Battery	80 g

SPECIFIED CONDITIONS OF USE

The laser distance measurer can be used for measuring distances and tilts.
Do not use this product in any other way as stated for normal use.

ERROR CODE TABLE

Code	Description	Solution
Err01	Out of measuring range	Measure in a proper range
Err02	Reflect signal is too weak	Choose a better surface
Err03	Out of display range (max value: 99.999) e.g. result of area or volume is out of display range	Check and verify values and steps are correct
Err04	Pythagorean calculation error	Check and verify values and steps are correct
Err05	Battery is low	Install new batteries
Err06	Out of working temperature	Measure in an environment with the specified working temperature
Err07	Ambient light is too strong	Measure in a darker place (shadow target)

Single Pythagoras
Height difference

Measuring Reference

Normal Measuring Mode

Minimum / Maximum for continuous Measure

Addition / Subtraction

Area/ Volume
Indirect Surface Measurement

Battery Status

Memory

Timer

Continuous measure mode

Among Values

Main Value

ON / MEASURE

- ▶ On
- ▶ Measure
- ▶ Continuous Measurement (push 2 sec)
+ Min / Max Function

ADD

- ▶ Add value
- ▶ Navigate in memory menu

AREAS / VOLUMES

- ▶ Area (push 1x)
- ▶ Volume (push 2x)
- ▶ Indirect Surface Measurement (push 3x / 4x)

POWER

- ▶ On
- ▶ Off (push 2 sec)
- ▶ Clear

SUBTRACT

- ▶ Subtract value
- ▶ Navigate in memory menu

PYTHAGORAS

- ▶ Pythagoras 1 (push 1x)
- ▶ Pythagoras 2 (push 2x)
- ▶ Pythagoras 3 (push 3x)

CHANGE POINT OF MEASURE

- ▶ Front
- ▶ Back (Standard automatical)
- ▶ Corner pin

MEMORY

- ▶ Timer 3-15 sec (push 1x)
- ▶ Memory 1-20 (push 1x, 2 sec)
- ▶ Use +/- to navigate the measures in memory

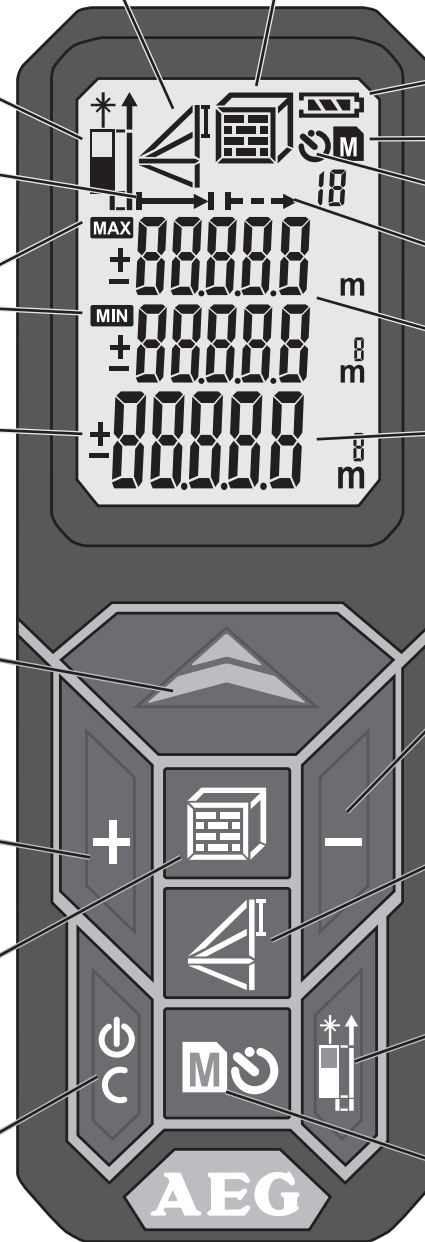

CHANGE BATTERIES

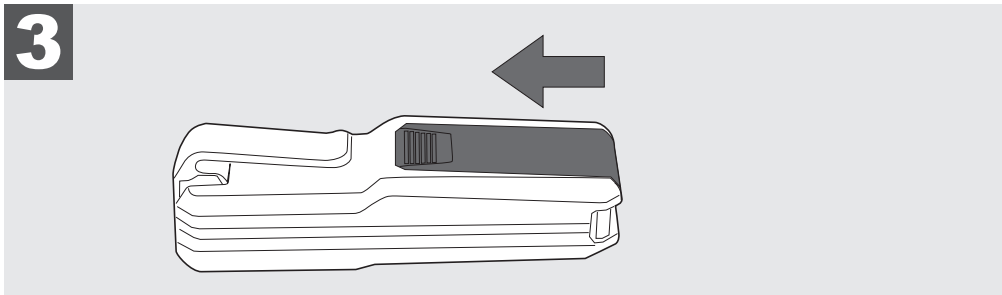
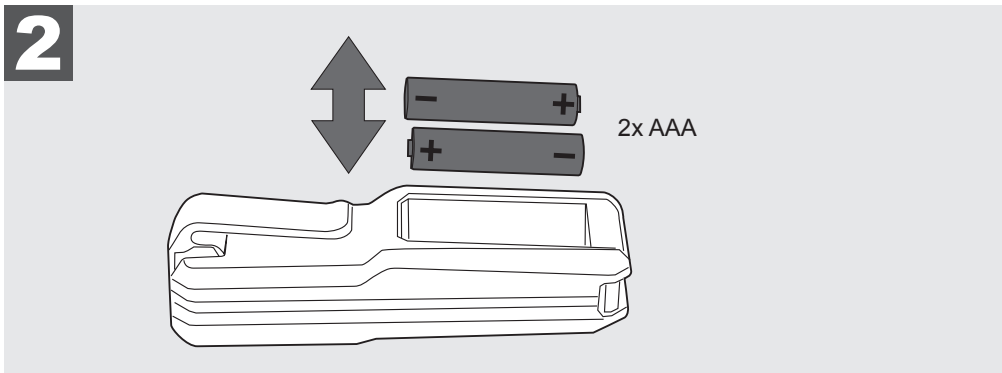
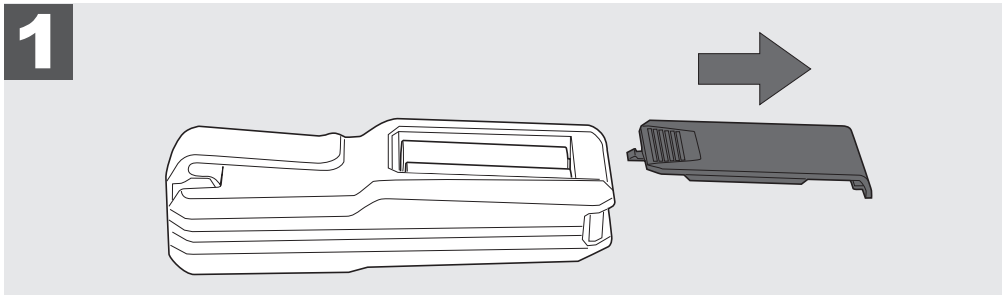
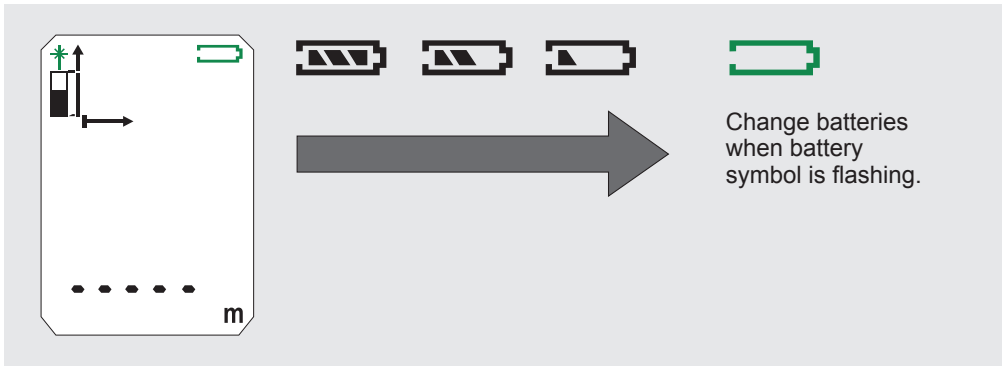

CORNER PIN

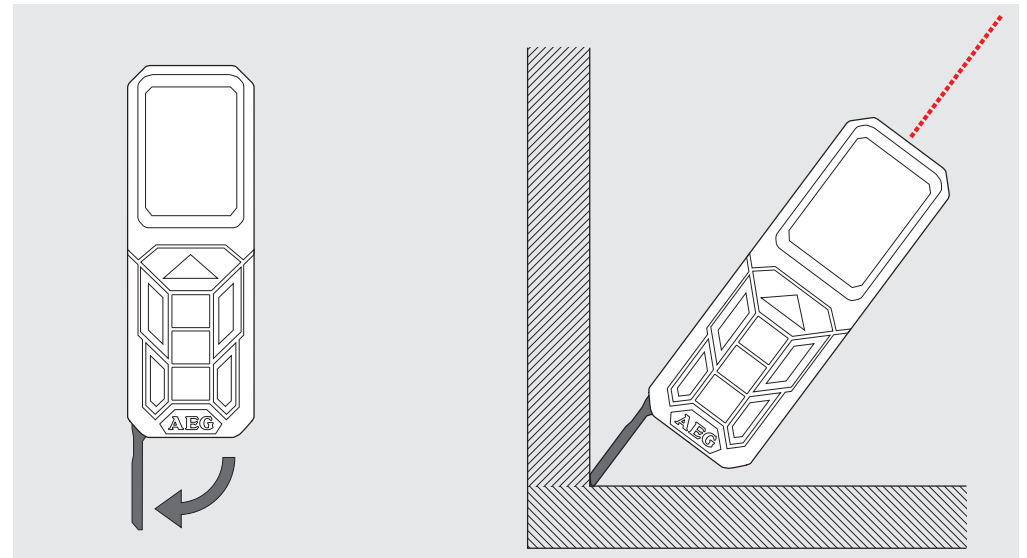

BELT CLIP

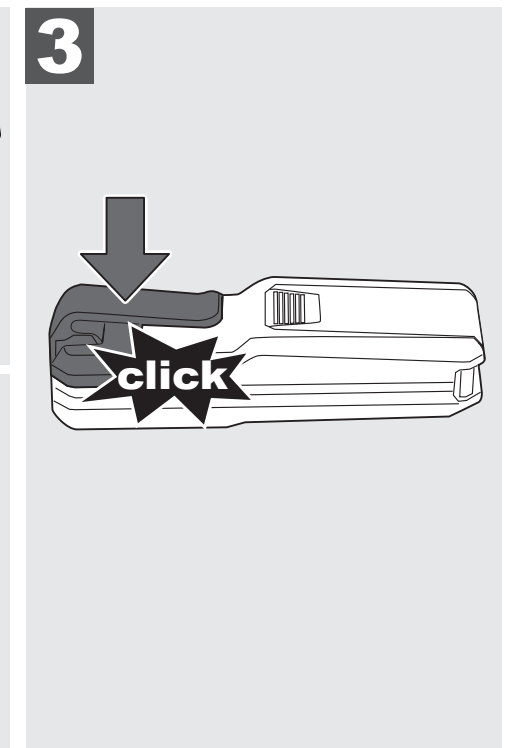
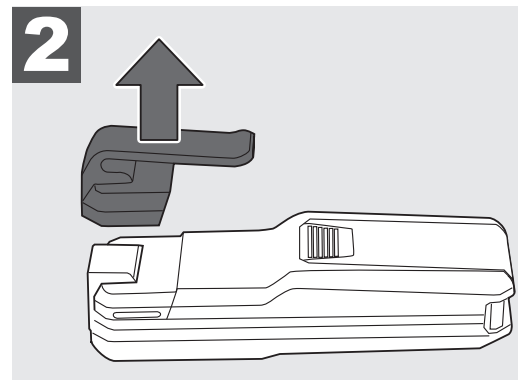
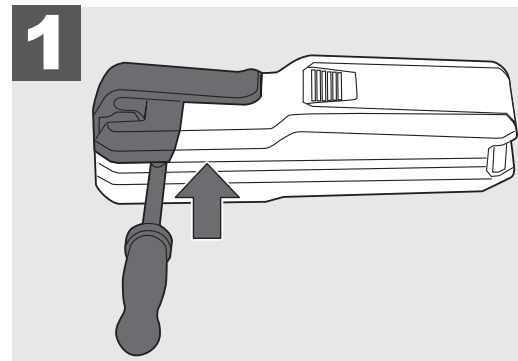

FUNCTION SWITCH, PYTHAGORAS, MEASURING REFERENCE

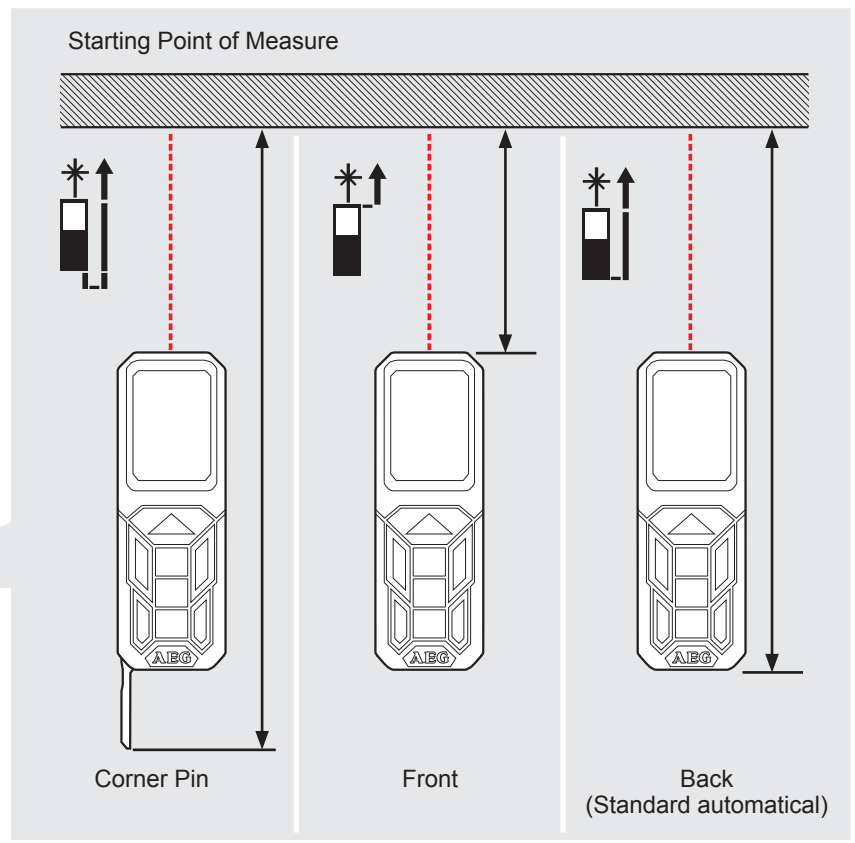
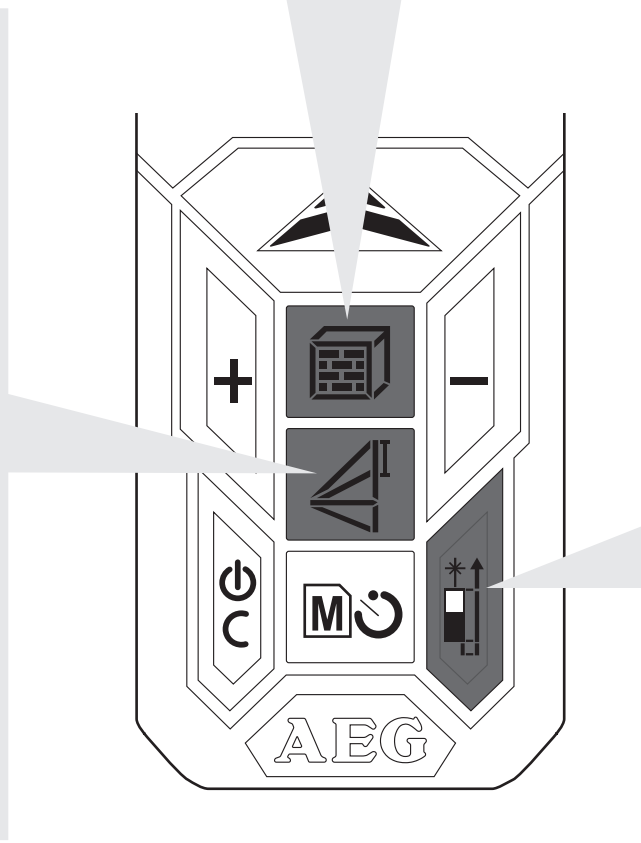
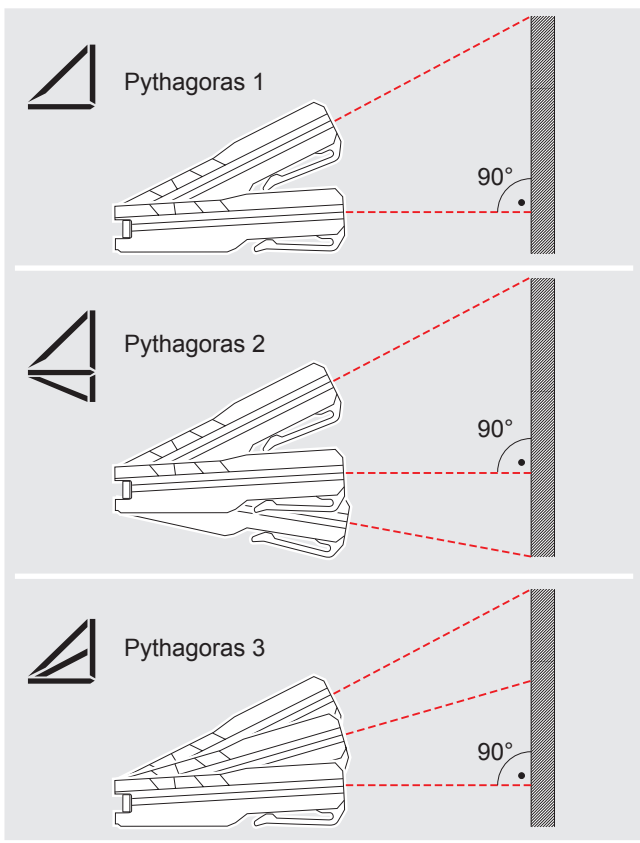
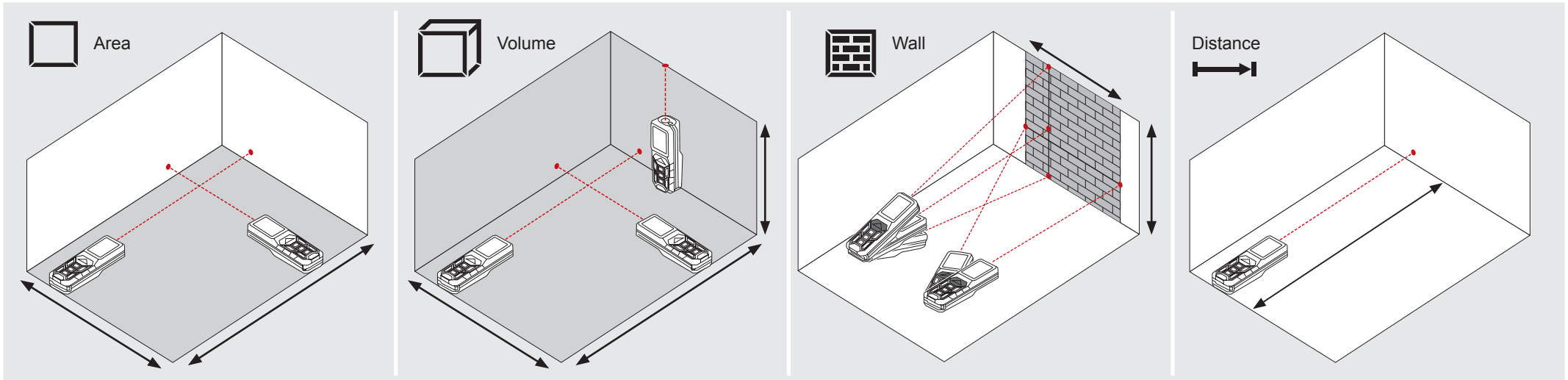

SINGLE DISTANCE MEASURING

0

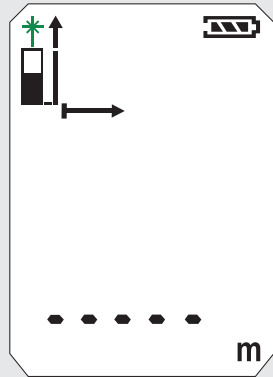

1

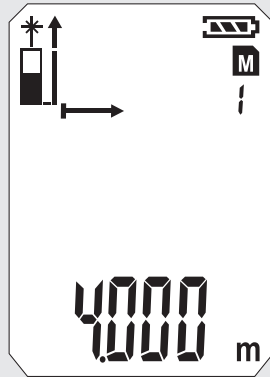
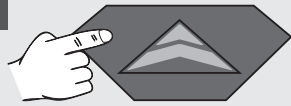

2

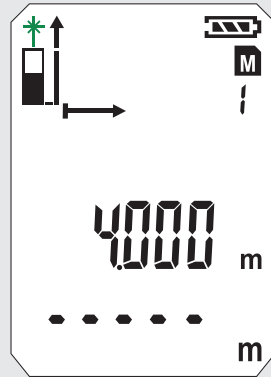
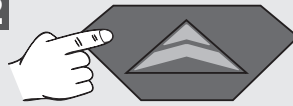

3

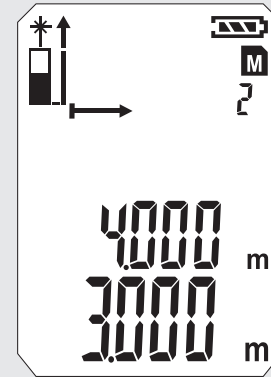
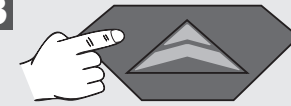

4

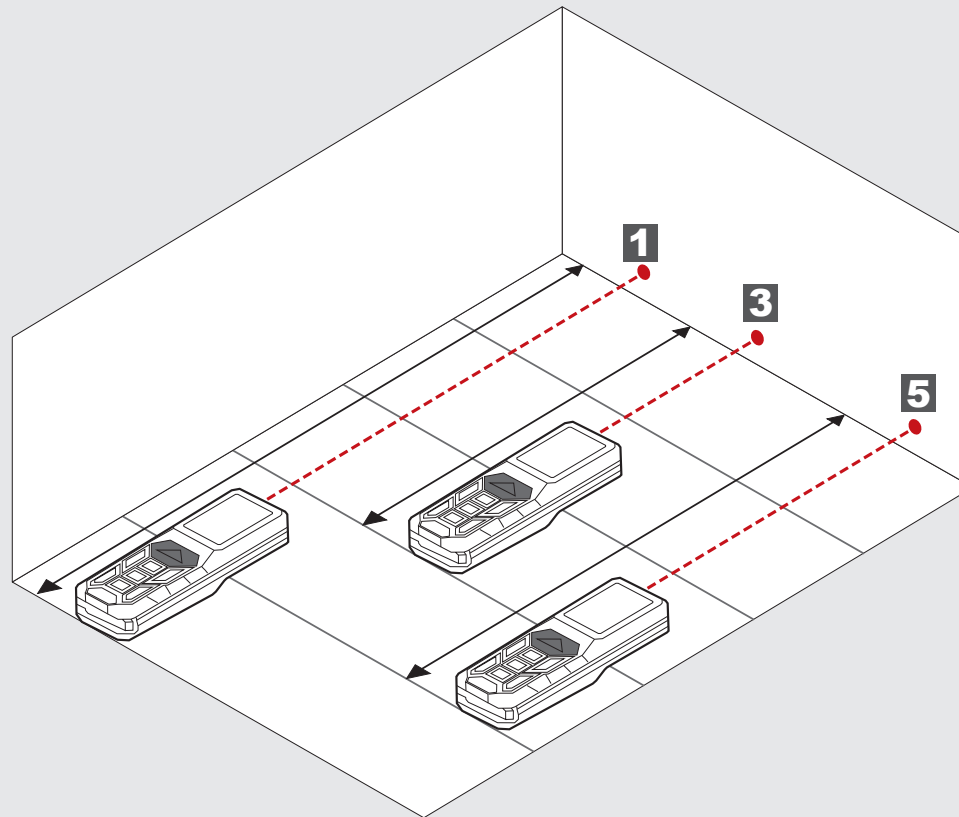
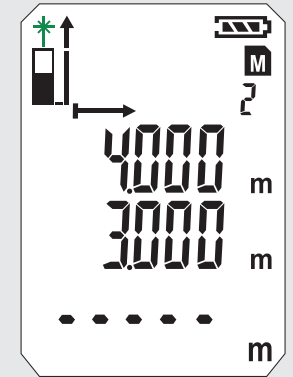
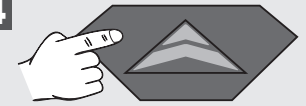

5

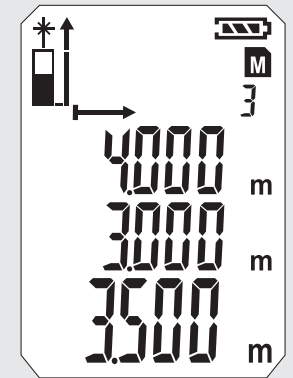
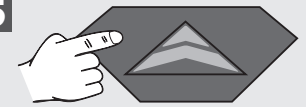

PERMANENT / MINIMUM-MAXIMUM MEASURING

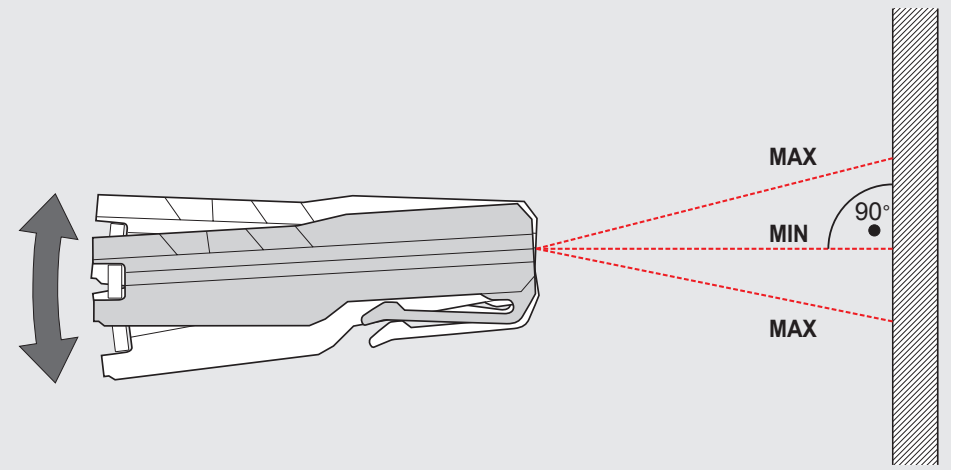
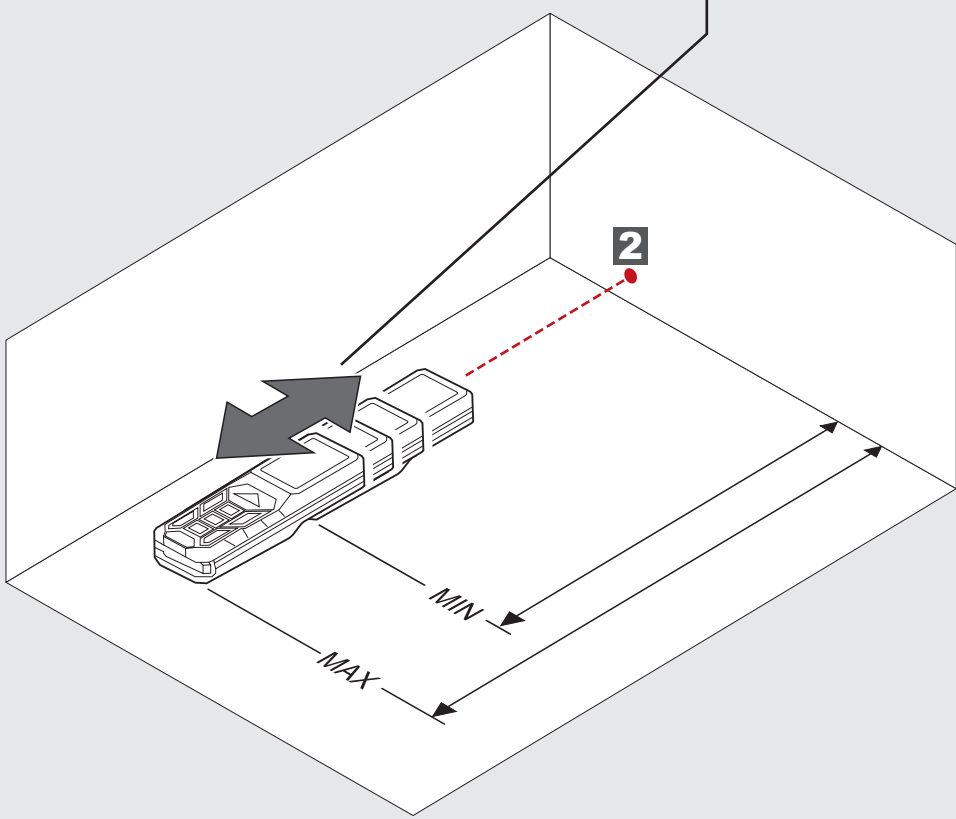
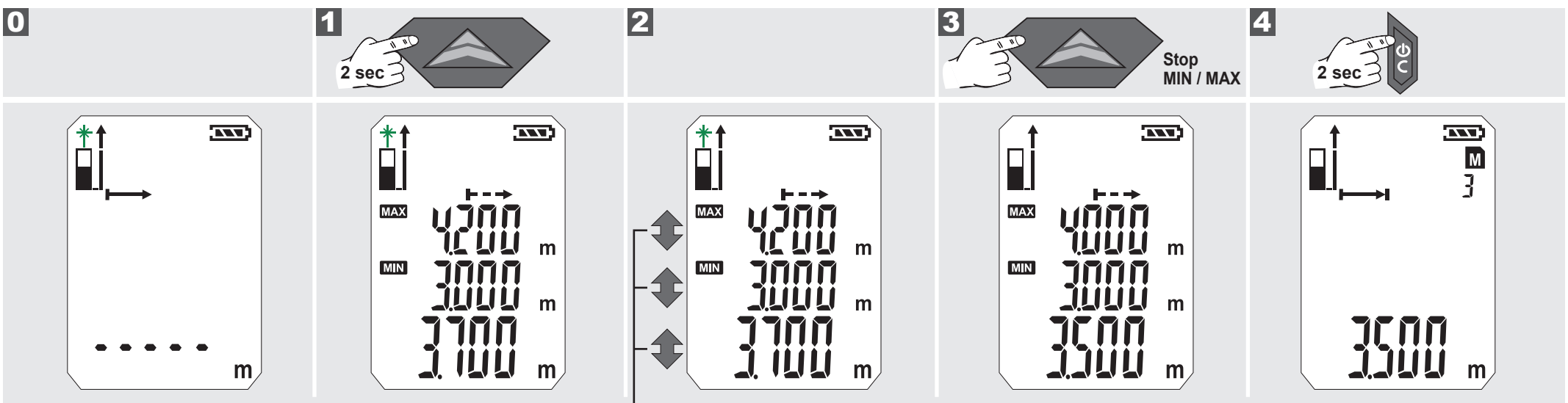

ADD / SUBTRACT MEASURING

0

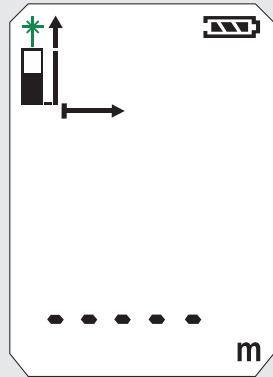

1

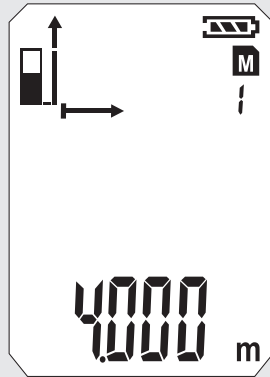
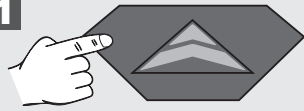

2

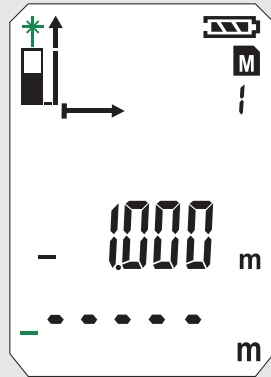
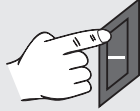

3

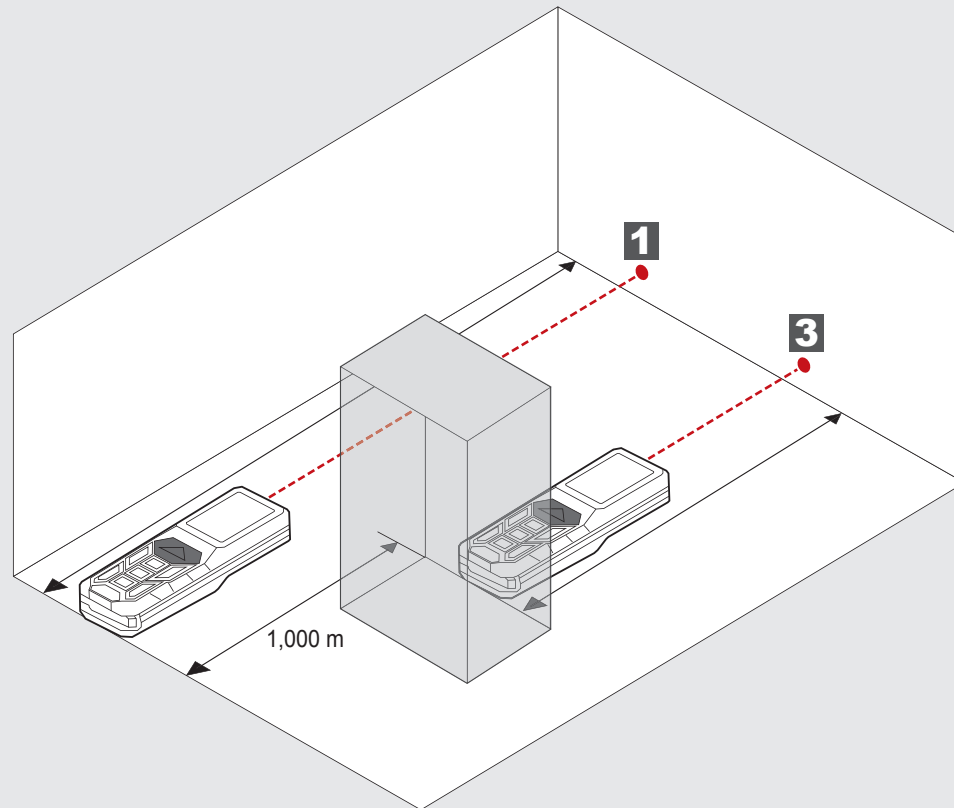
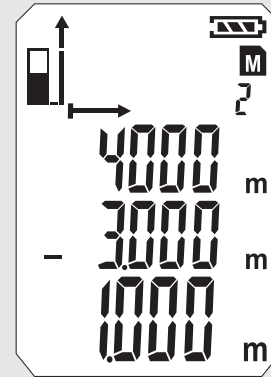
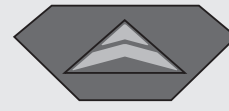

AREA MEASURING

0

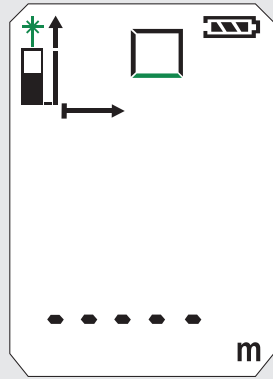

1

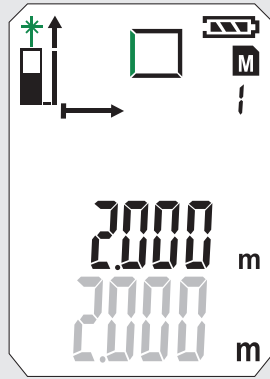
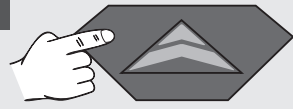

2

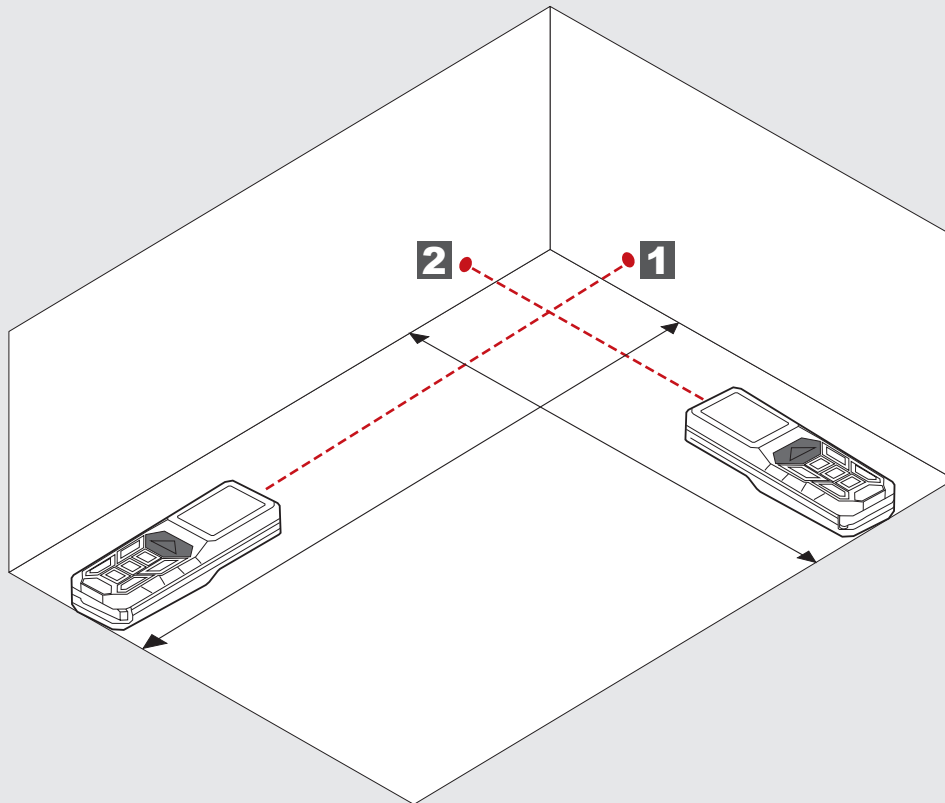
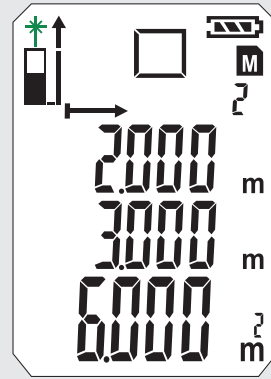
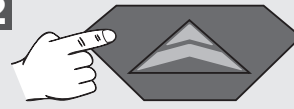

VOLUME MEASURING

0

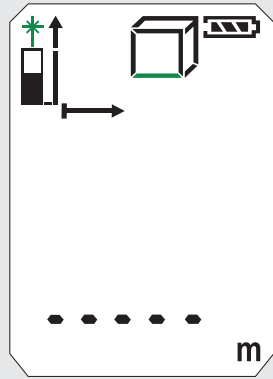

1

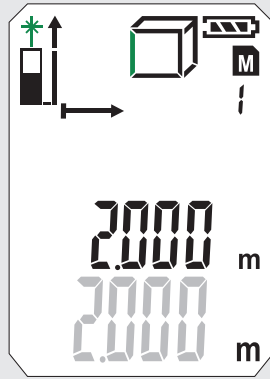
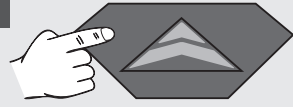

2

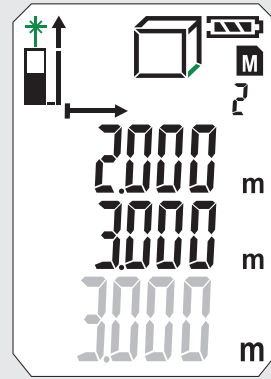
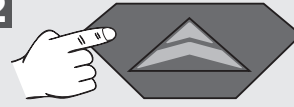

3

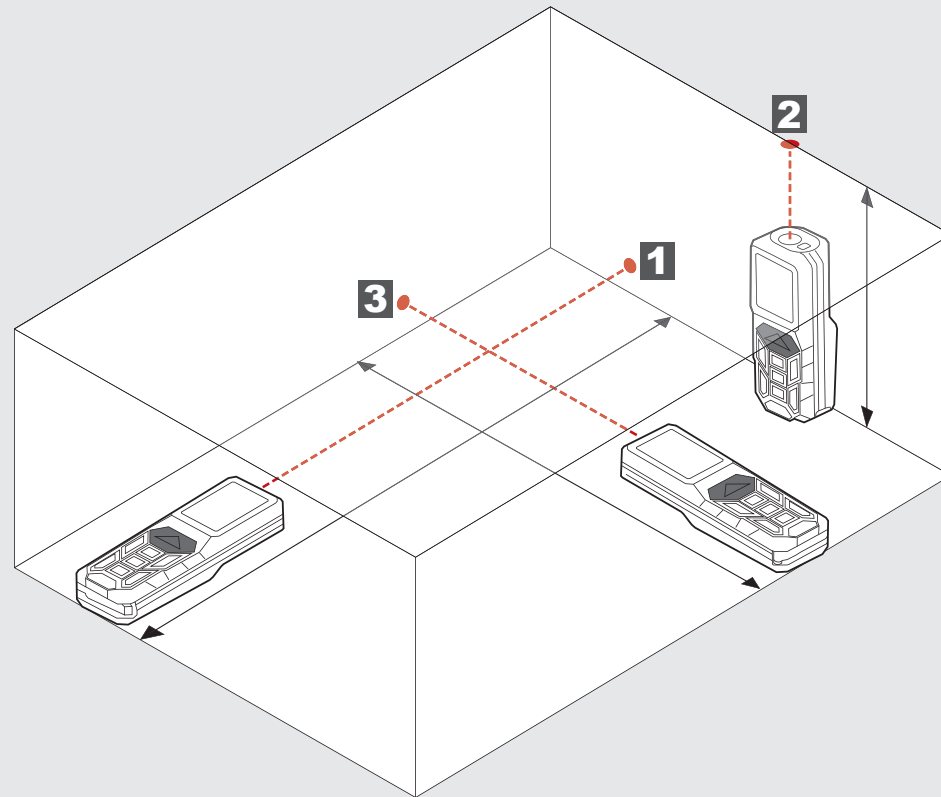
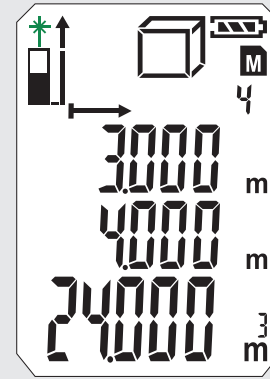
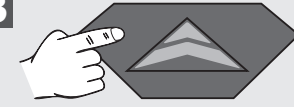

INDIRECT MEASURING (PYTHAGORAS 1)

0



1

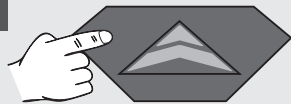

2

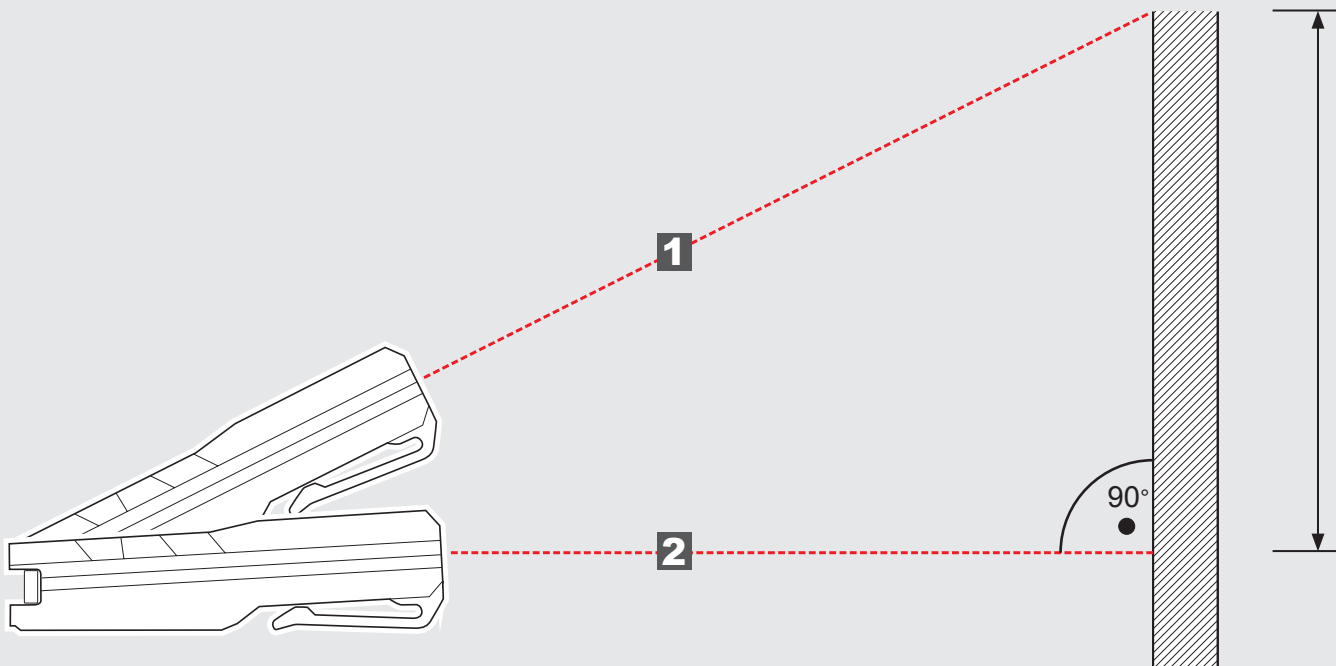
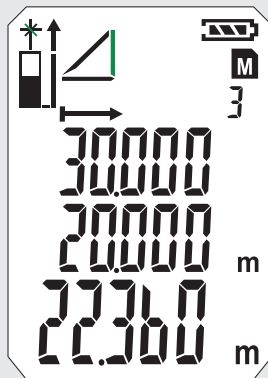
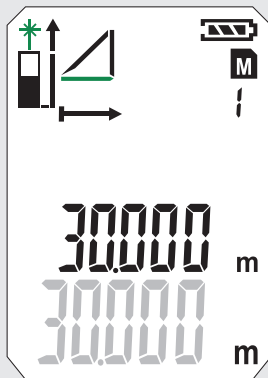
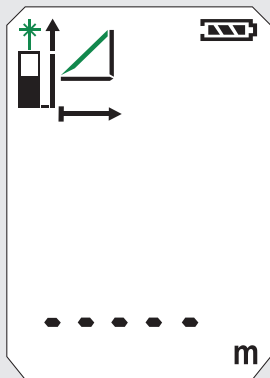
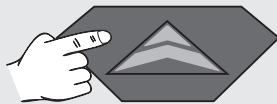

INDIRECT MEASURING (PYTHAGORAS 2)

0



1

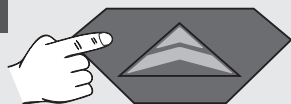

2

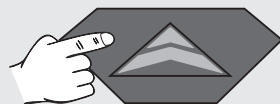

3

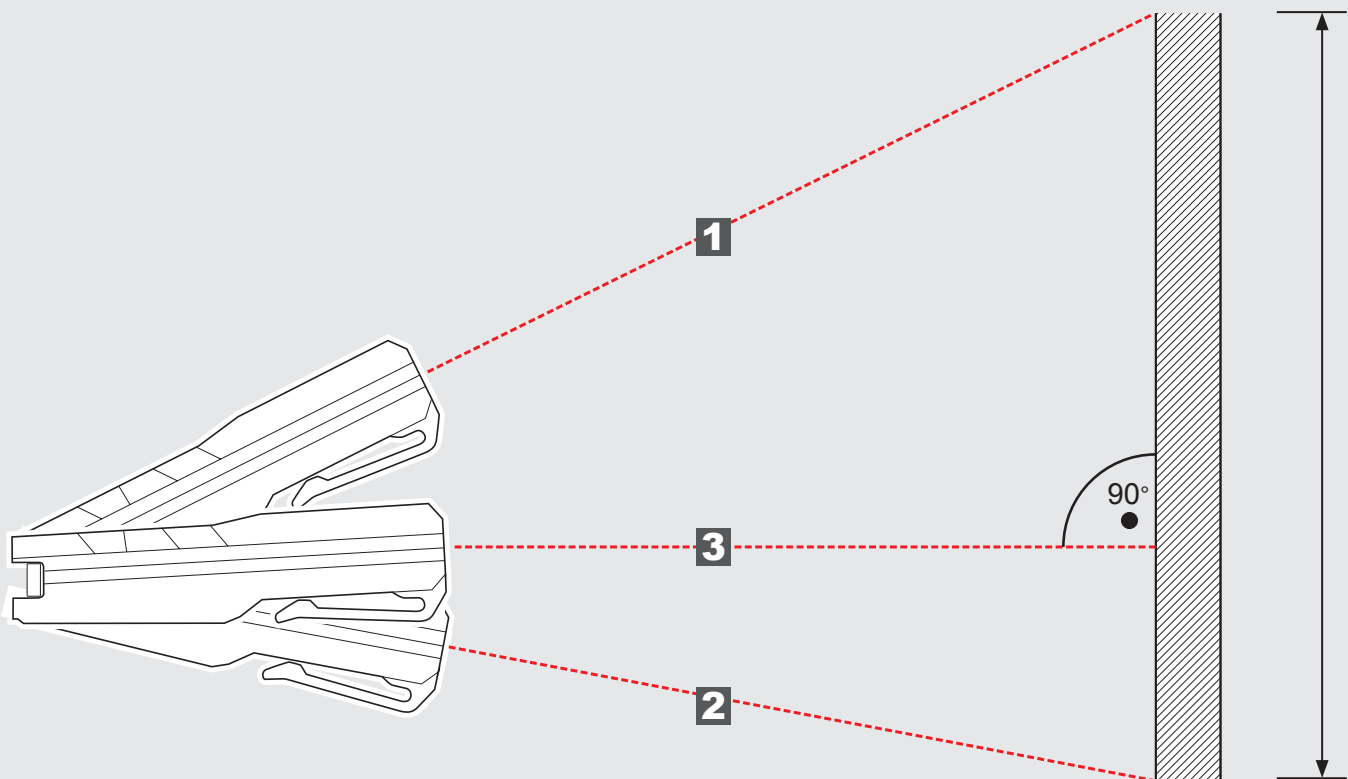
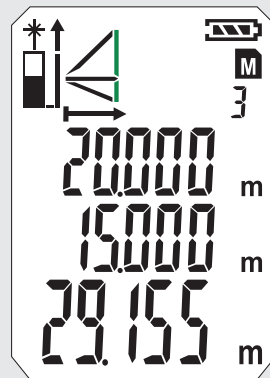
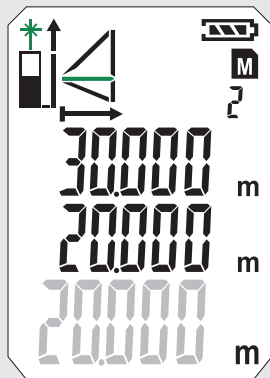
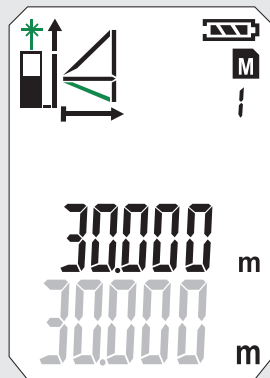
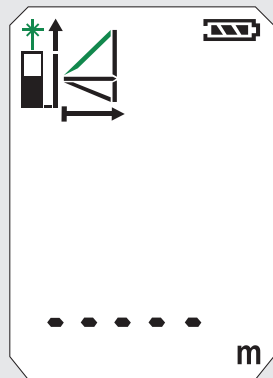

INDIRECT MEASURING (PYTHAGORAS 3)

1



2

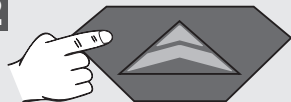



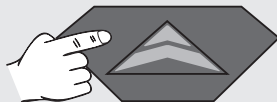

3

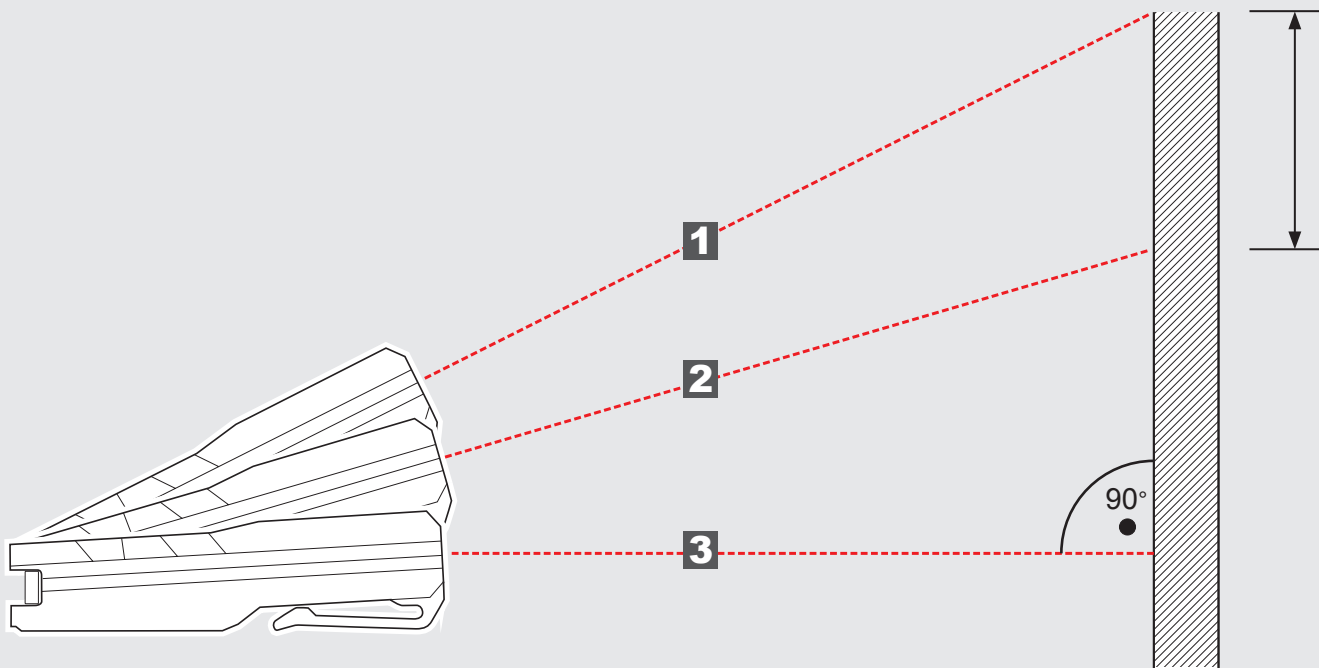
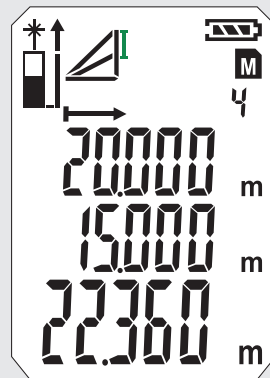
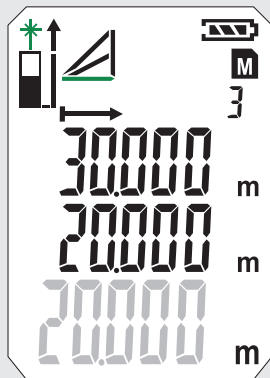
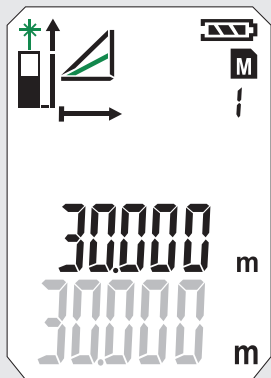
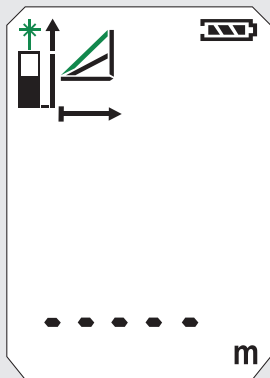

4

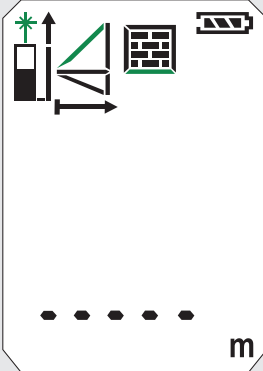
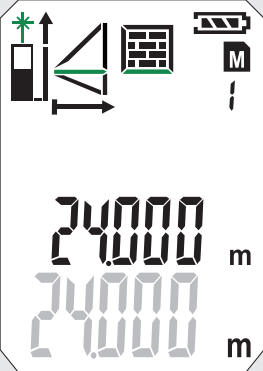
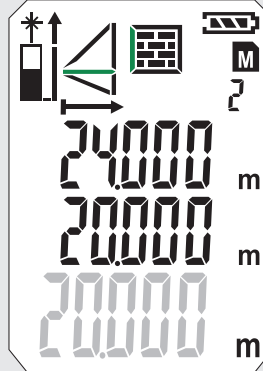
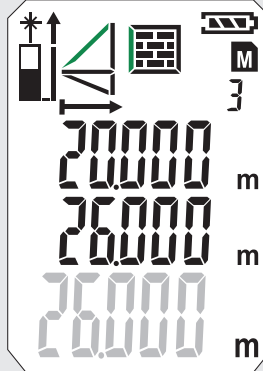
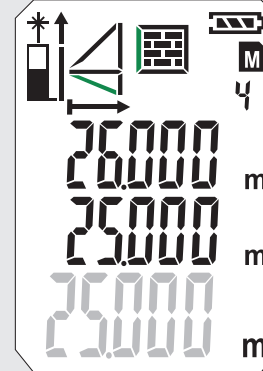

WALL AREA MEASURING (SCENARIO 1)

<p>0</p> 	<p>1</p> 	<p>2</p> 	<p>3</p> 	<p>4</p> 
				

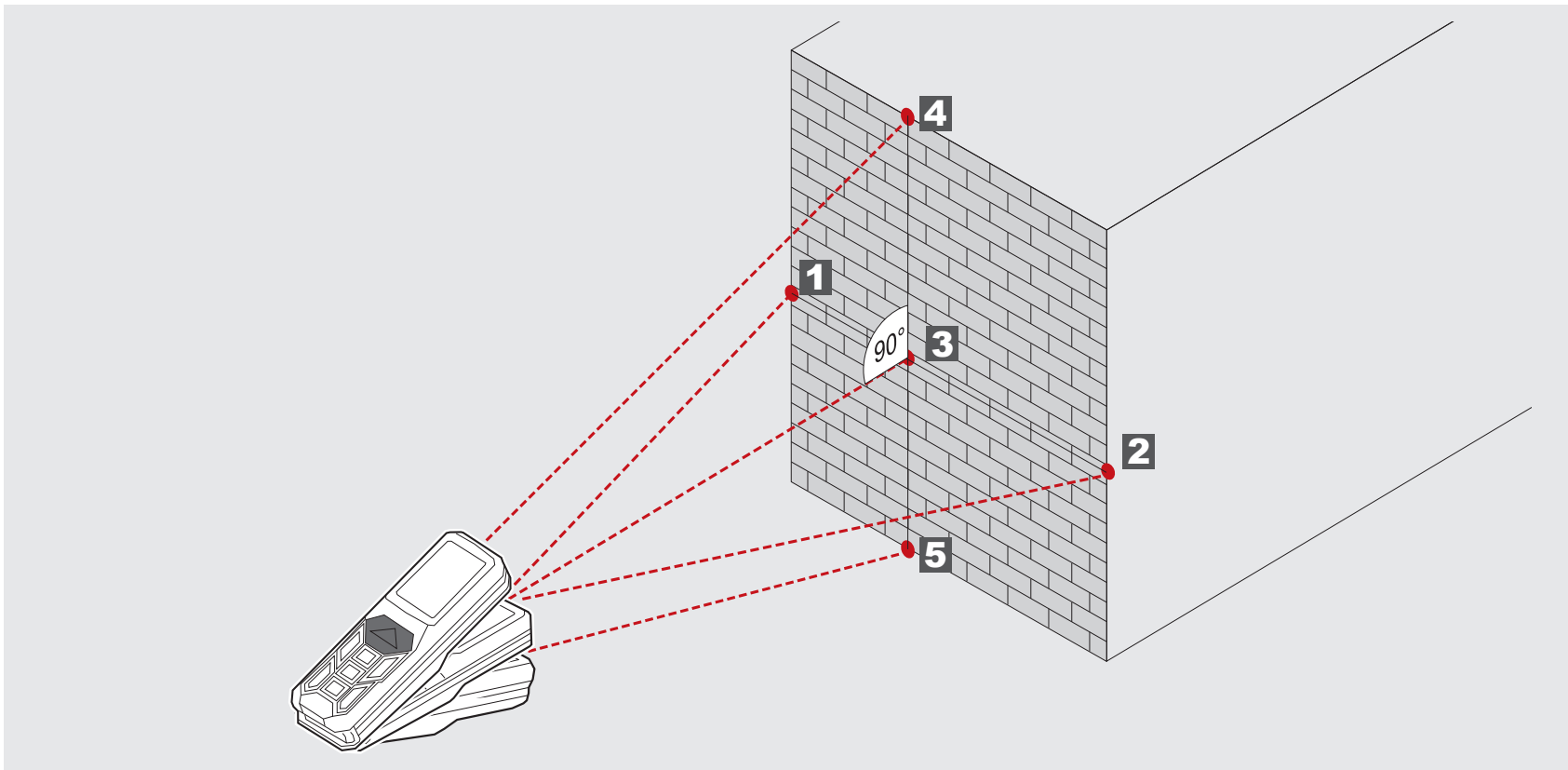



5

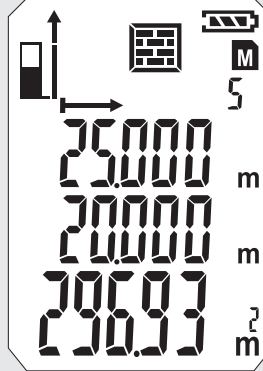

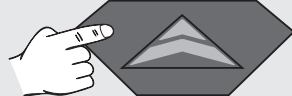
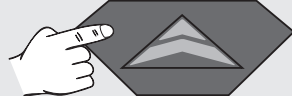
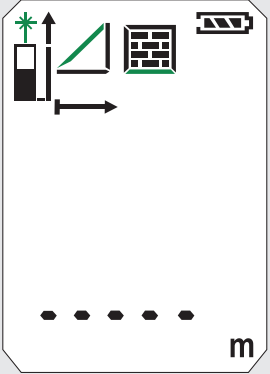
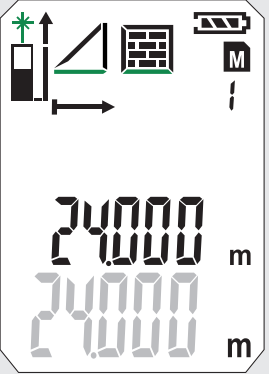
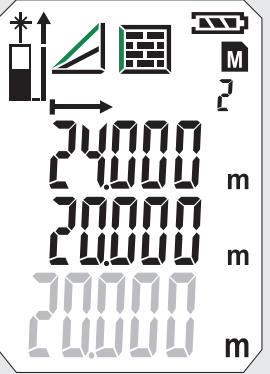
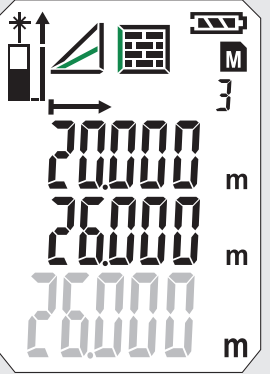
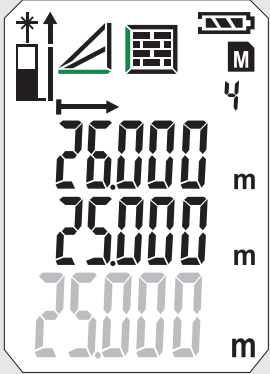

WALL AREA MEASURING (SCENARIO 2)

0 	1 	2 	3 	4 
				

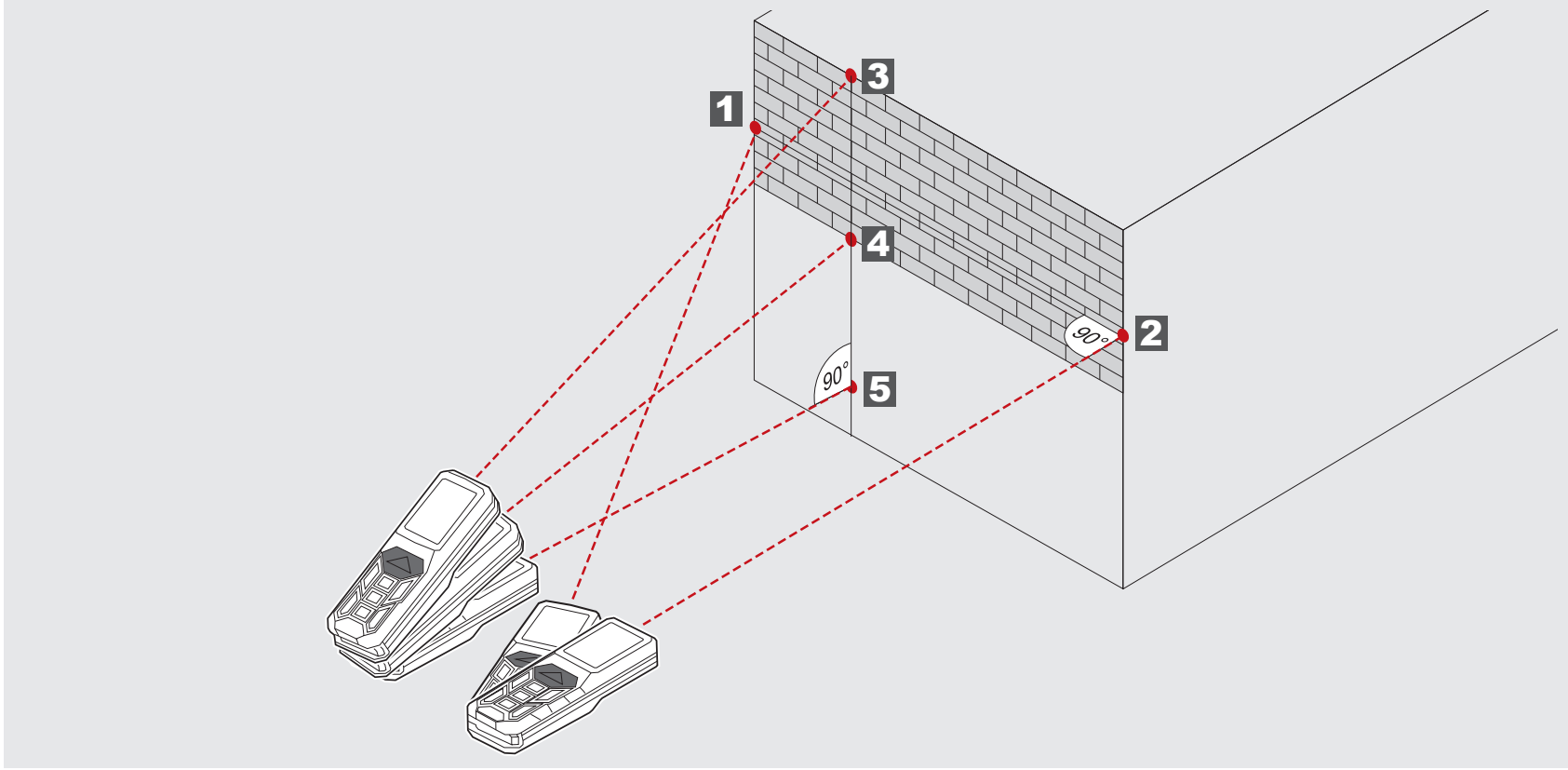

5



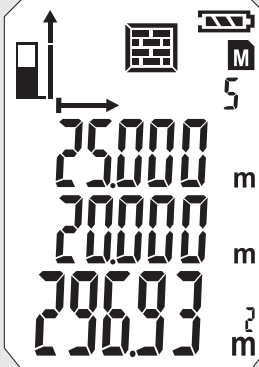

TIMER

With the timer, the measurement can be start delayed. For example to position a part in the measuring beam.

Push button 

- Icon is displayed.
- Timer can be set between 3 to 15 sec by pressing the button .

Push button 

- The seconds are counted down until the measurement starts.
- At 0, the measurement starts.

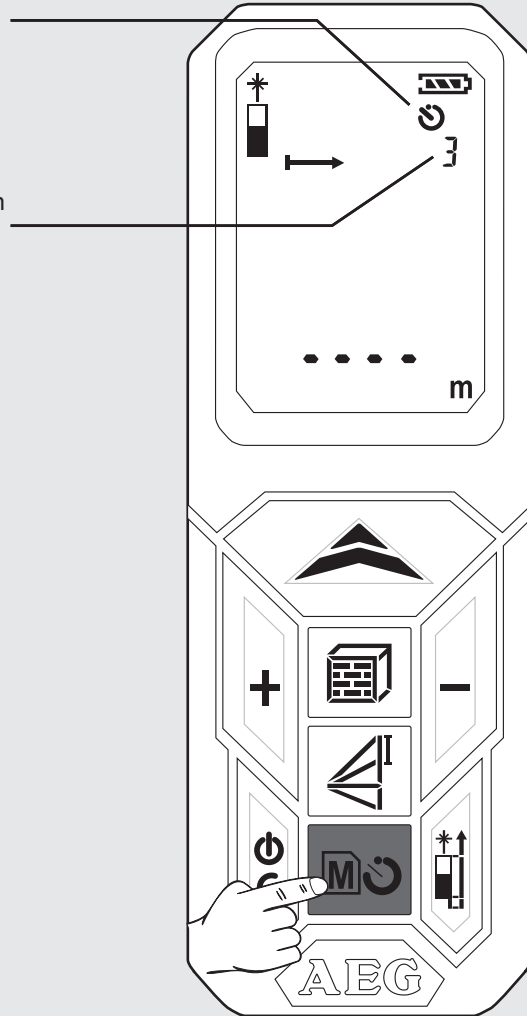

MEMORY

The measured values are stored continuously and automatically in memory.

The stored values can be retrieved by pushing the button .

Push the button  2 sec.

- Icon and memory number appears.
- associated measured parameter is shown.
- Stored value is displayed in the main line.
- Navigate with the + / - buttons

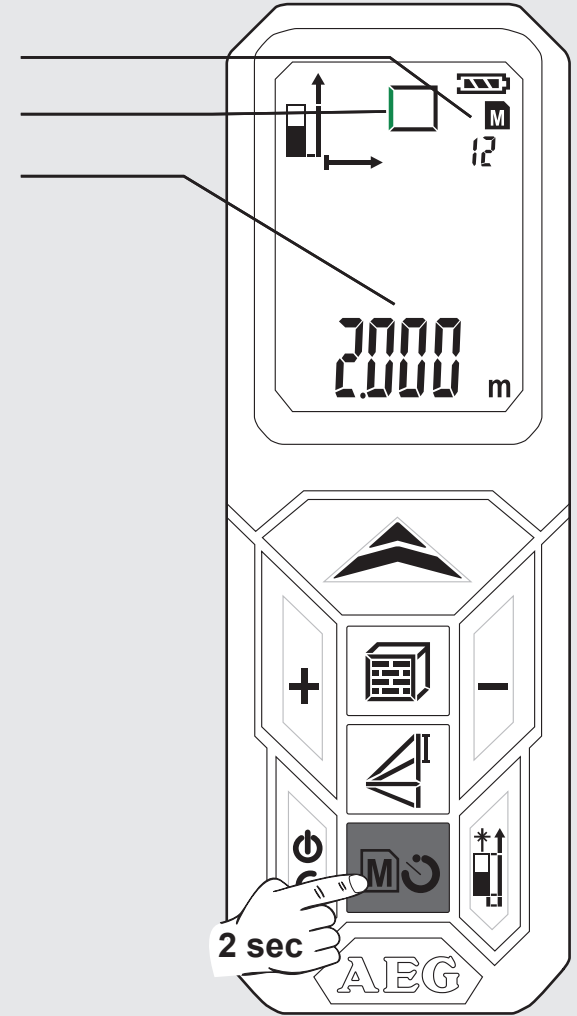



BASIC DESCRIPTION ON EXAMPLE OF AREA MEASURING (1)

1 Turn On

Push Button 
⚠ Attention! Laser on!
 Do not point it at a person!

2 Choose Measuring Reference

Standard after turning on: Bottom
 Push 1x -> Corner Pin
 Push 2x -> Top
 Push 3x -> Bottom

3 Choose Function

After switching on the device is always on single distance measurement
 Push 1x - Area Measurement.

4 Measure length

Level the device and push button 

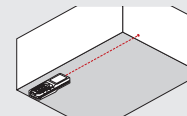

5 Measure width

Level the device and push button 

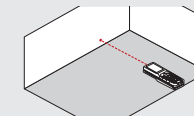

Lasericon flashes (flashing green illustrated).

Icon is displayed.

- Icon appears.
 - Measured parameter flashes (flashing green illustrated)

- Measured value appears briefly in the main line.
 - Measured value jumps by 1 sec in line above.
 - Measured value is stored in memory at consecutive numbers.
 - Second measured parameter flashes.
 - Device ready for measurement of the second value.

- Measured value appears briefly in the base line.
 - Measured value jumps by 1 sec in line above.
 - Measured value is stored in memory at consecutive numbers.
 - Result is displayed in the main line and stored in memory at consecutive numbers.

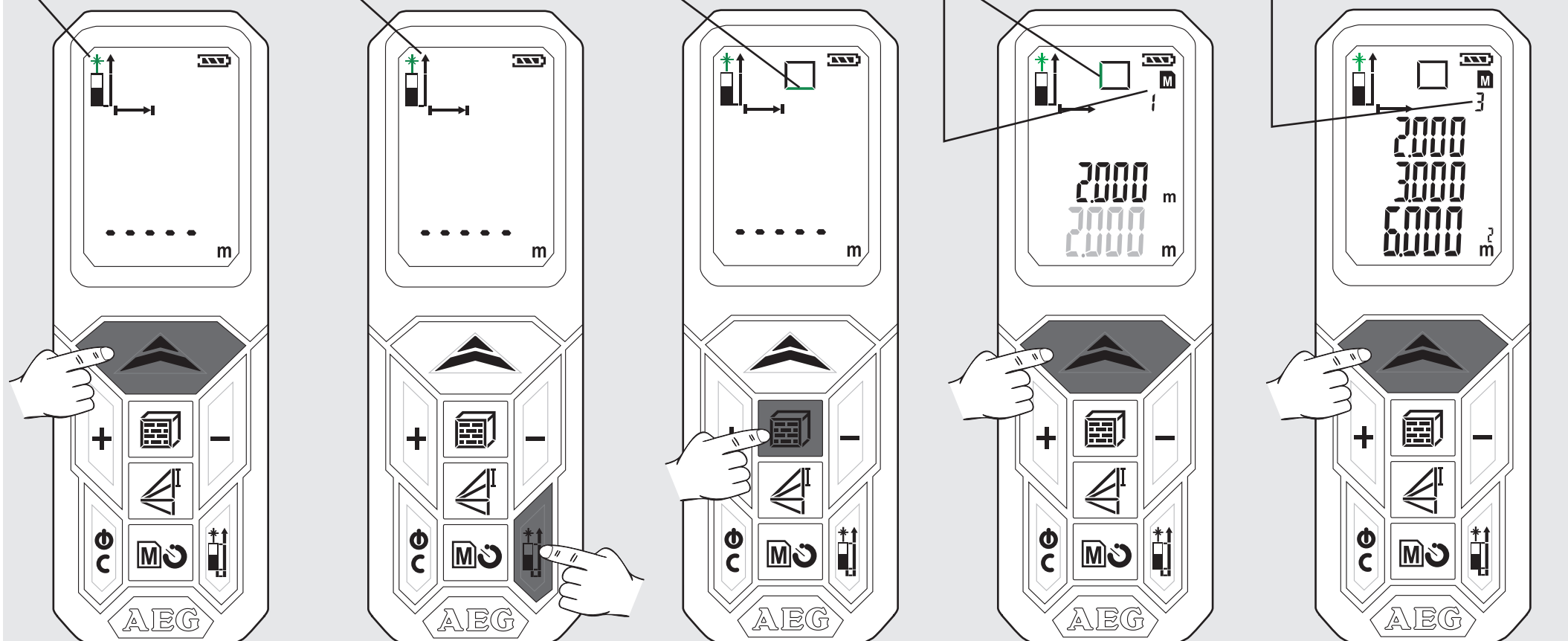

BASIC DESCRIPTION ON EXAMPLE OF AREA MEASURING (2)

6 View stored values

Push button  2 sec.
Push + or push -

7 Exit memory

Push button .

8 Switch off

Push button  2 sec
(Memory must be exited before)

- Stored values appears in the main line.

Associated icon appears and measured parameter flashes (flashing green illustrated)

- Device switches off.

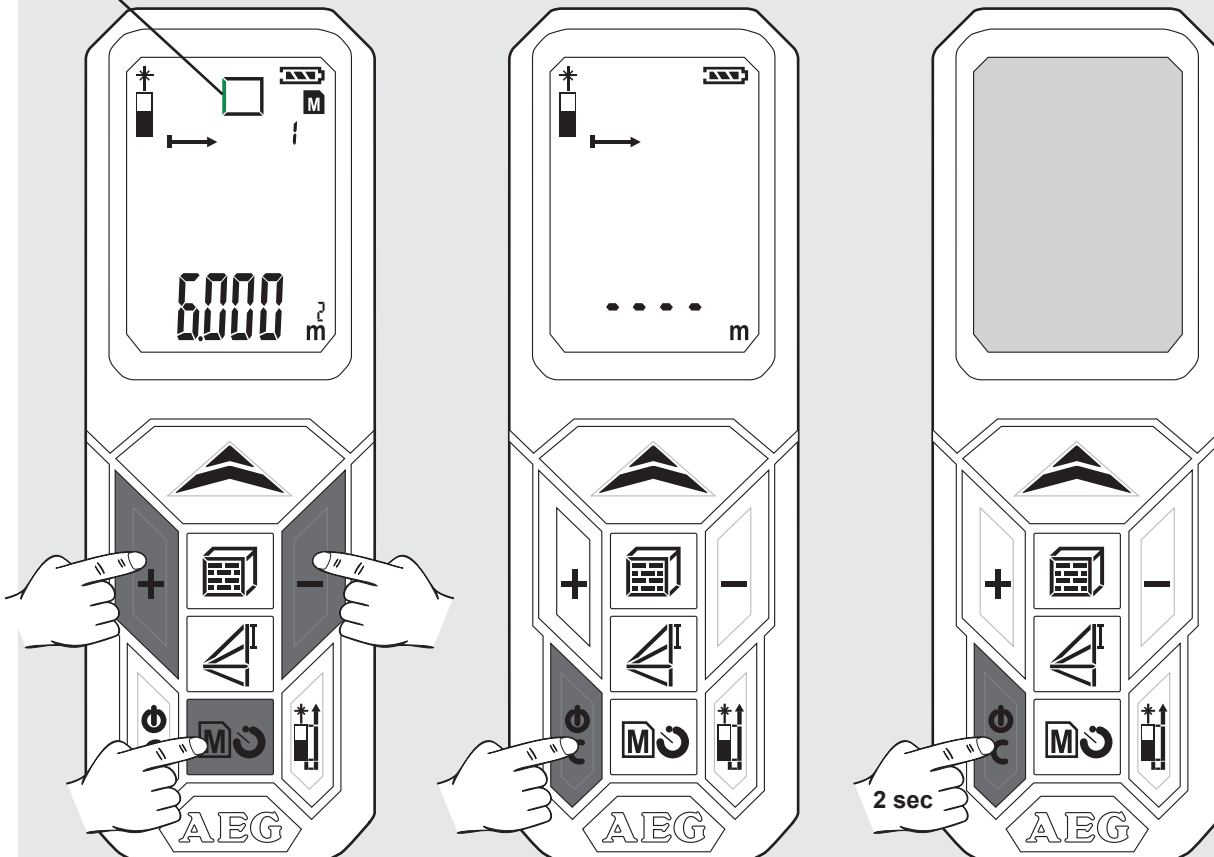

- If no button is pressed, the device switches off automatically after 3 minutes.



INHALT

Wichtige Sicherheitshinweise.....1
 Technische Daten2
 Bestimmungsgemäße Verwendung.....2
 Fehlercode Tabelle2
 Übersicht3
 Batterie wechseln4
 Eckenstift4
 Gürtelhalter.....4
 Funktionstaste, Pythagoras, Messebene5
 Einfache Längenmessung6
 Kontinuierliche Messung / Minimum-Maximum Messung7
 Additions- / Subtraktionsmessung8
 Flächenmessung9
 Volumenmessung10
 Indirekte Messung (Pythagoras 1).....11
 Indirekte Messung (Pythagoras 2).....12
 Indirekte Messung (Pythagoras 3).....13
 Wandflächenmessung (Szenario 1)14
 Wandflächenmessung (Szenario 2)15
 Timer16
 Speicher16
 Grundlegende Funktionsweise am Beispiel einer Flächenmessung (1).....17
 Grundlegende Funktionsweise am Beispiel einer Flächenmessung (2).....18

WICHTIGE SICHERHEITSHINWEISE

  Nehmen Sie das Produkt erst in Gebrauch, wenn Sie die Sicherheitshinweise und die Gebrauchsanweisung auf der beiliegenden CD gelesen haben.

Laserklassifizierung

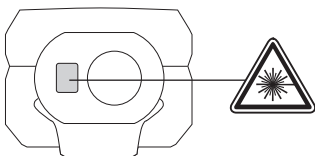

WARNUNG:
 Das Produkt entspricht der Laserklasse 2 gemäss IEC 60825-1:2007.



Beschriftung

Überkleben Sie den englischen Text auf dem Leistungsschild vor der ersten Inbetriebnahme mit dem mitgelieferten Aufkleber in Ihrer Landessprache.

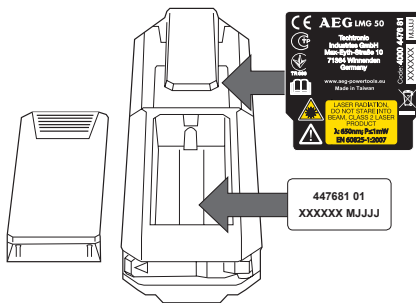

Warnung:

Vermeiden Sie direkten Blickkontakt. Der Laserstrahl kann die Augen verblitzen und zu einer kurzzeitigen Blendung führen. Nicht in den Laserstrahl blicken und Strahl nicht unnötigerweise auf andere Personen richten. Keine anderen Personen blenden.

Warnung:

Das Laser-Gerät nicht in der Nähe von Kindern betreiben oder Kindern erlauben, das Laser-Gerät zu benutzen. Achtung! Eine reflektierende Oberfläche könnte den Laserstrahl zurück an den Bediener oder andere Personen reflektieren.

Halten Sie einen entsprechenden Sicherheitsabstand zu den beweglichen Teilen.

Regelmässige Kontrollmessungen durchführen, insbesondere vor, während und nach wichtigen Messaufgaben.

Vorsicht vor fehlerhaften Messungen beim Verwenden eines defekten Produkts, nach einem Sturz oder sonstigen unzulässigen Anwendungen bzw. Veränderungen am Produkt.

Warnung: Die Verwendung von Steuerelementen, Einstellungen oder die Durchführung von anderen als den im Handbuch festgelegten Verfahren kann zu gefährlicher Strahlenbelastung führen.

Das Lasermessgerät hat einen begrenzten Einsatzbereich. (Siehe Abschnitt "Technische Daten"). Versuche, außerhalb des maximalen und minimalen Bereichs zu messen, verursachen Ungenauigkeiten. Der Einsatz bei widrigen Bedingungen, wie zu heiß, zu kalt, sehr hellem Sonnenlicht, Regen, Schnee, Nebel oder anderen sichteinschränkenden Bedingungen, kann zu ungenauen Messungen führen.

Wenn das Lasermessgerät von einer warmen Umgebung in eine kalte Umgebung gebracht wird (oder umgekehrt), warten Sie, bis sich das Gerät der neuen Umgebungstemperatur angepasst hat.

Das Lasermessgerät immer innerhalb von Räumen aufbewahren, das Gerät vor Erschütterung, Vibrationen oder extremen Temperaturen schützen.

Das Lasermessgerät vor Staub, Nässe und hoher Luftfeuchtigkeit schützen. Dies kann innere Bauteile zerstören oder die Genauigkeit beeinflussen.

Verwenden Sie keine aggressiven Reinigungsmittel oder Lösungsmittel. Nur mit einem sauberen, weichen Tuch reinigen.

Vermeiden Sie starke Schläge auf das oder den Fall des Lasermessgeräts. Die Genauigkeit des Gerätes sollte überprüft werden, wenn es heruntergefallen ist oder anderen mechanischen Belastungen ausgesetzt war.

Erforderlichen Reparaturen an diesem Laser-Gerät dürfen nur von autorisiertem Fachpersonal durchgeführt werden.

Das Produkt darf nicht in einer explosionsgefährdeten oder aggressiven Umgebung eingesetzt werden.

Zum Aufladen der Akkus nur vom Hersteller empfohlene Ladegeräte verwenden.

 Leere Batterien dürfen nicht über den Hausmüll entsorgt werden. Gebrauchte Batterien zur umweltgerechten Entsorgung gemäß nationaler oder lokaler Vorschriften an den dafür vorgesehenen Sammelstellen abgeben. Das Gerät darf nicht im Hausmüll entsorgt werden. Gerät sachgemäß entsorgen. Länderspezifische Entsorgungsvorschriften befolgen. Wenden Sie sich an die örtliche Behörde oder Ihren Händler, um Auskunft über die Entsorgung zu erhalten.



TECHNISCHE DATEN

Schutzklasse	IP54 (staub- und spritzwassergeschützt)
Optik	14 mm
Brennpunkt	35 mm
Messbereich max.	50 Meter (Toleranz: 55 m)
Messbereich min.	0,05 Meter
Absolute Genauigkeit @ < 10m	± 1,5 mm (Max)
Wiederholgenauigkeit @ < 10m	± 1,5 mm (typisch max. 2σ)
Wiederholgenauigkeit @ > 10m	Anstieg ± 0,25 mm / Meter (typisch max. 2σ)
Messzeit	0,5 s
Display Typ	LCD (22,7 mm x 31 mm)
Stromversorgung	AAA 2x (Alkaline-Batterie)
Batterielebensdauer	10000 (Einzelmessung)
Laser Ausgangsleistung	0,6 mW ~ 0,95 mW (Class 2, 650nm)
Laserpunktgröße	25 x 30 mm @ 16 m (Max)
Laserstrahl Vertikalwinkel	+1 Grad
Laserstrahl Horizontalwinkel	±1 Grad
Automatische Geräteabschaltung	180 Sekunden
Automatische Laserabschaltung	30 Sekunden
Arbeitstemperaturbereich	-10°C to +50°C
Lagertemperaturbereich	-25°C to +70°C
Gewicht ohne Batterie	80 g

BESTIMMUNGSGEMÄSSE VERWENDUNG

Das Lasermessgerät ist geeignet zum Messen von Distanzen und Neigungen.
Dieses Gerät darf nur wie angegeben bestimmungsgemäß verwendet werden.

FEHLERCODE TABELLE

Code	Beschreibung	Lösung
Err01	Außerhalb des Messbereiches	Messung im vorgesehenen Bereich durchführen.
Err02	Reflektiertes Signal ist zu schwach	Eine bessere Oberfläche wählen.
Err03	Außerhalb des Anzeigebereiches (max. Wert: 99.999) z.B. ist das Ergebnis von Fläche oder Volumen außerhalb des Anzeigebereiches	Prüfen, ob die Werte und Schritte korrekt sind.
Err04	Fehler in der Pythagorasberechnung	Prüfen, ob die Werte und Schritte korrekt sind.
Err05	Battery schwach	Neue Batterien einsetzen.
Err06	Außerhalb des Arbeitstemperaturbereichs	Messung im vorgegebenen Arbeitstemperaturbereich durchführen.
Err07	Umgebungslicht zu hell	Zielbereich abdunkeln.

Pythagoras
Höhendifferenz

Messebene

Längenmessung

Minimum / Maximum für kontinuierliche Messung

Addition / Subtraktion

EIN / MESSEN

- ▶ Ein
- ▶ Messen
- ▶ Kontinuierliche Messung (2 sek drücken)
Min. / Max. Funktion

ADDITION

- ▶ Wert addieren
- ▶ Navigieren im Speicher

FLÄCHE / VOLUMEN

- ▶ Fläche (1x drücken)
- ▶ Volumen (2x drücken)
- ▶ Indirekte Flächenmessung (3x / 4x drücken)

EINSCHALTEN

- ▶ Ein
- ▶ Aus (2 sek drücken)
- ▶ Zurücksetzen

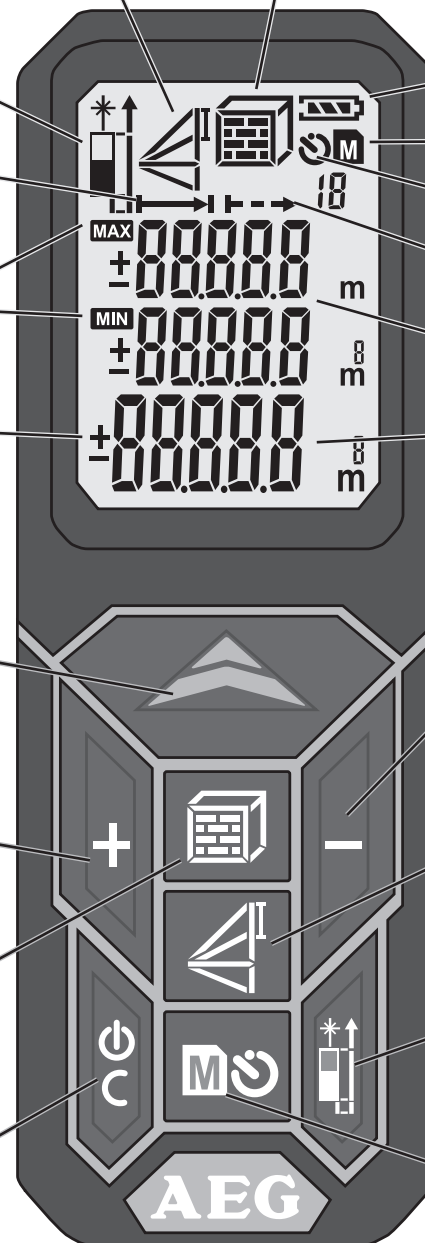

Fläche / Volumen
Indirekte Flächenmessung

Batteriestatus

Speicher

Timer

Kontinuierliche Messung

Zwischenwerte

Gesamtwert

SUBSTRAKTION

- ▶ Wert subtrahieren
- ▶ Navigieren im Speicher

PYTHAGORAS

- ▶ Pythagoras 1 (1x drücken)
- ▶ Pythagoras 2 (2x drücken)
- ▶ Pythagoras 3 (3x drücken)

MESSEBENE WECHSELN

- ▶ Vorn
- ▶ Hinten
- ▶ Eckenstift

SPEICHER

- ▶ Timer 3-15 sek (1x drücken)
- ▶ Speicher 1-20 (1x 2 sek drücken)
- ▶ Mit den +/- Tasten im Speicher navigieren

BATTERIE WECHSELN

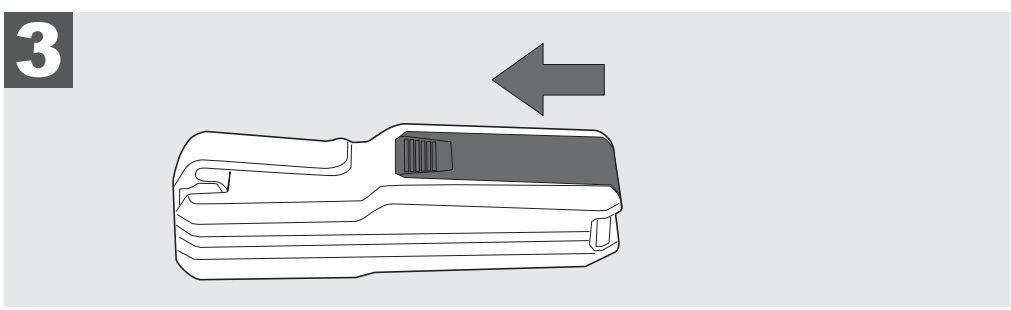
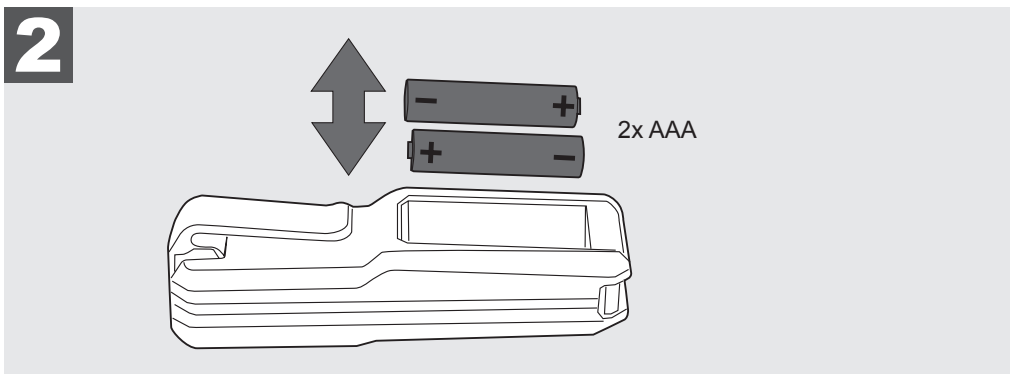
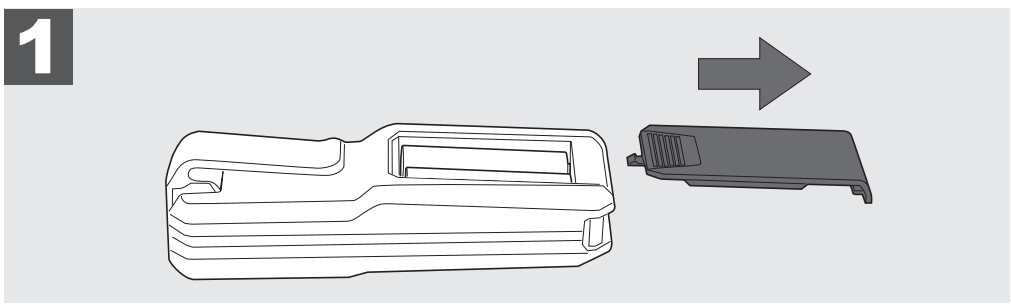
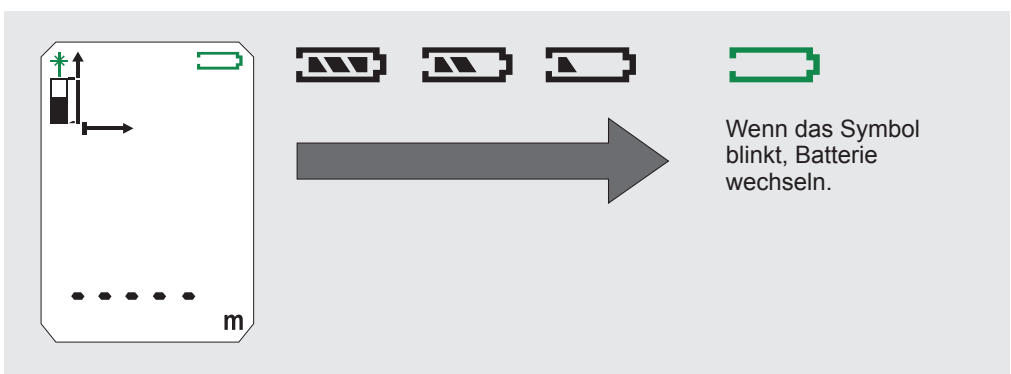

ECKENSTIFT

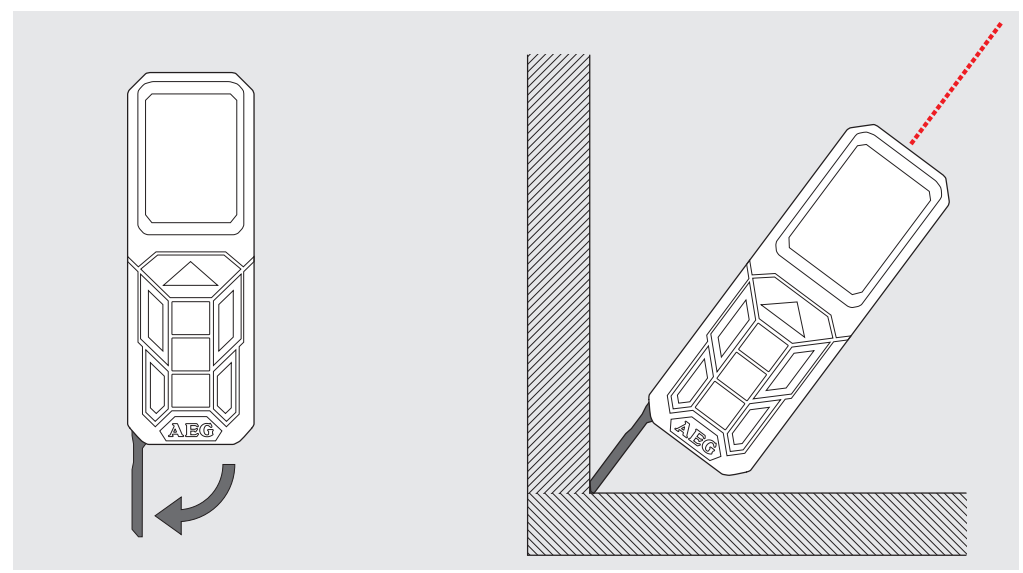

GÜRTELHALTER

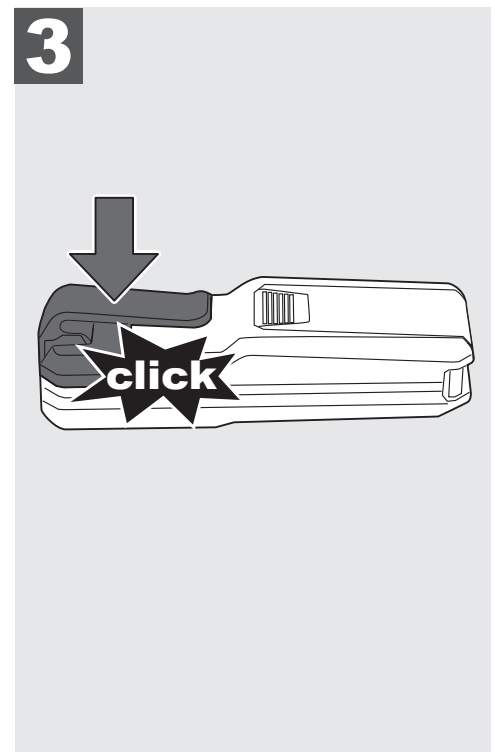
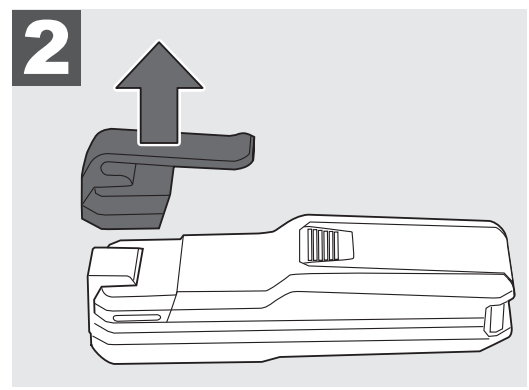
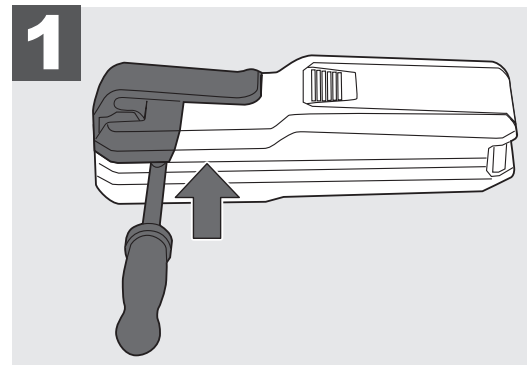

FUNKTIONSTASTE, PYTHAGORAS, MESSEBENE

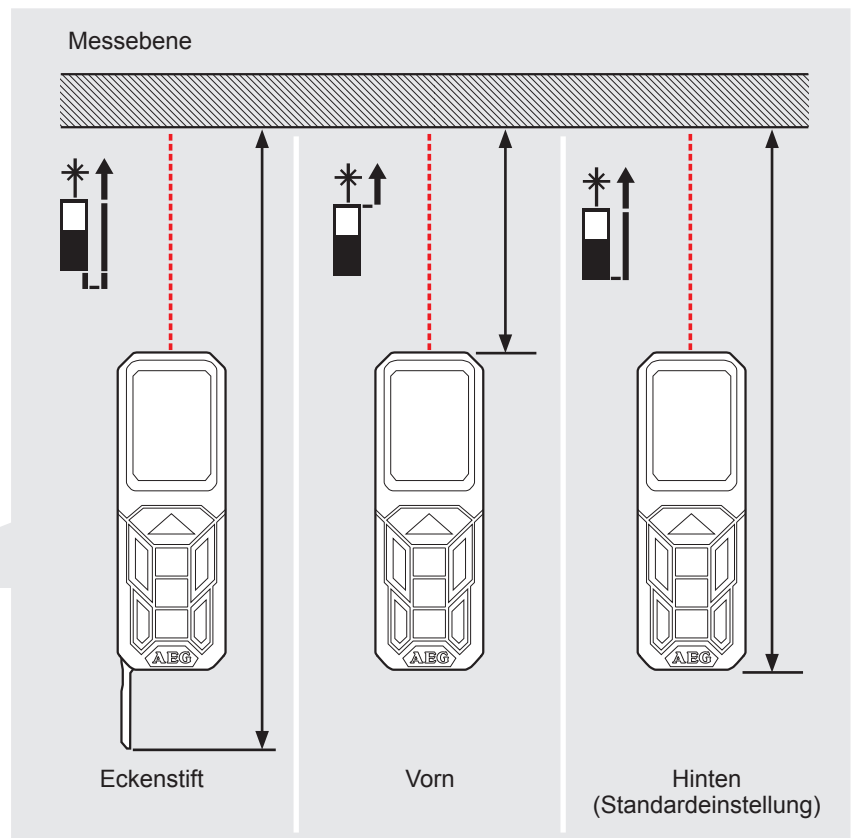
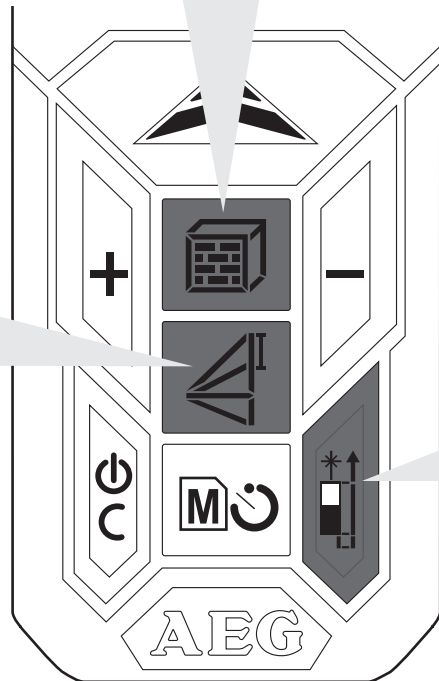
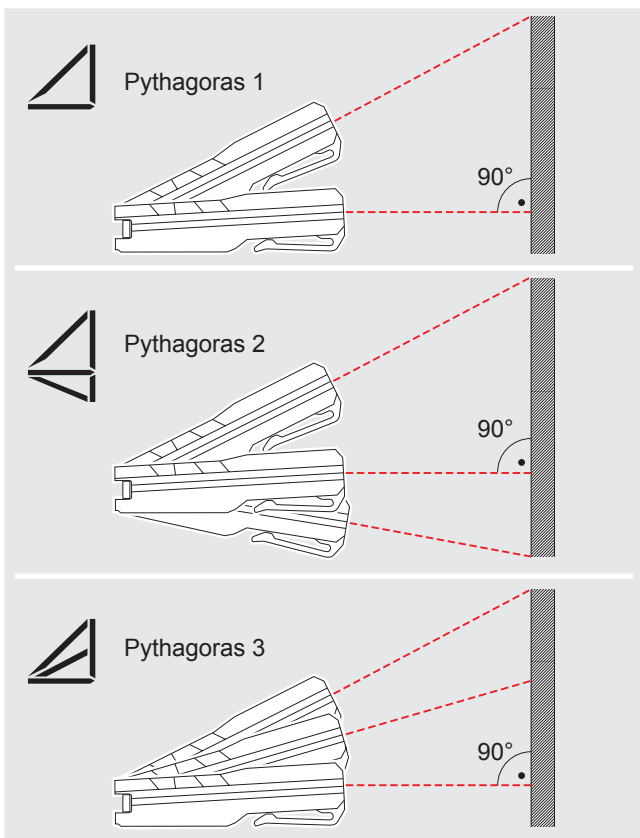
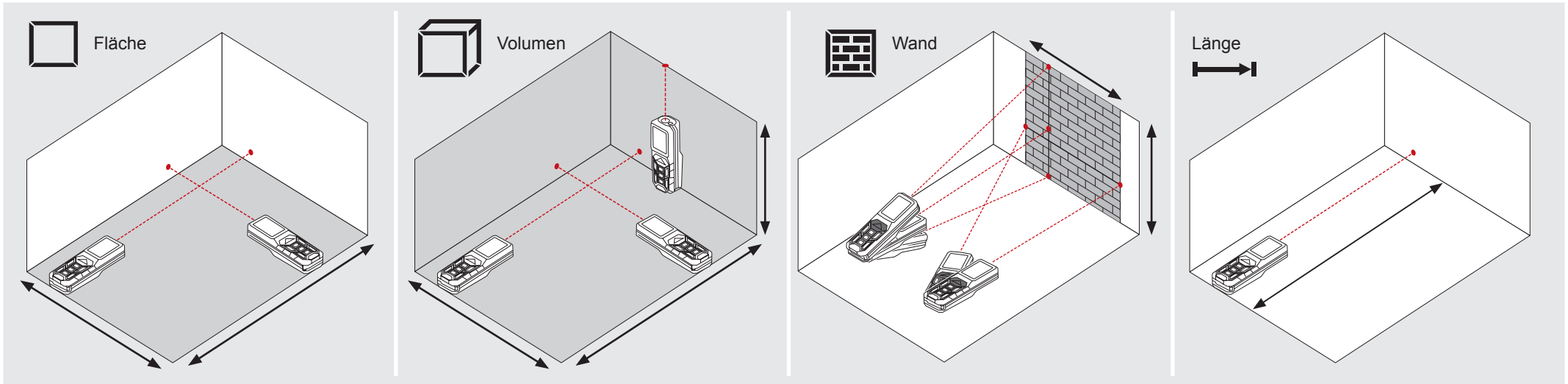

EINFACHE LÄNGENMESSUNG

0

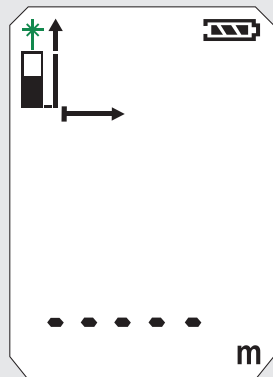

1

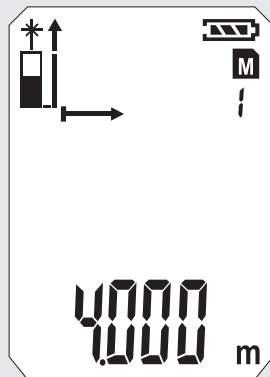
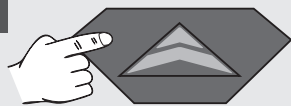

2

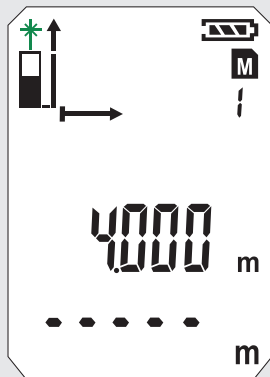
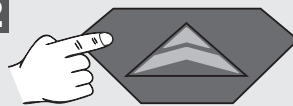

3

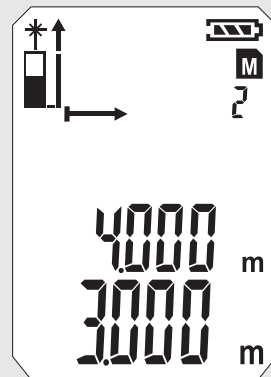
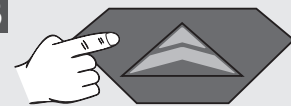

4

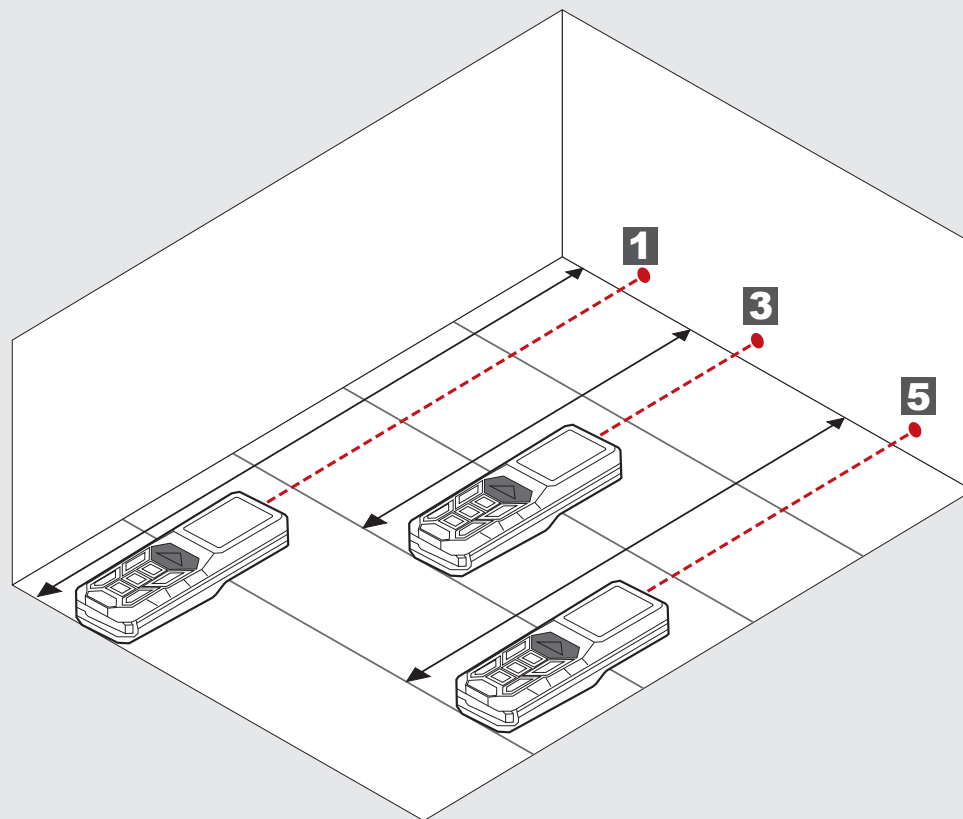
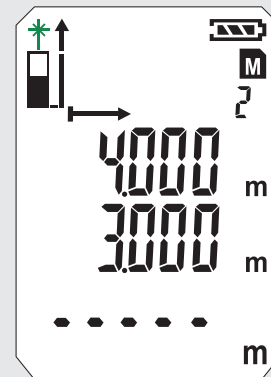
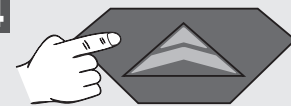

5

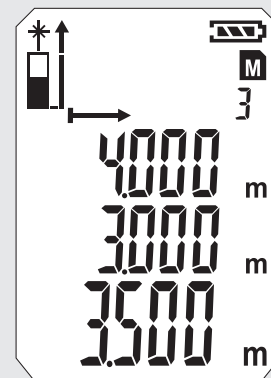
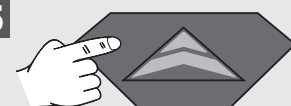

KONTINUIERLICHE MESSUNG / MINIMUM-MAXIMUM MESSUNG

0

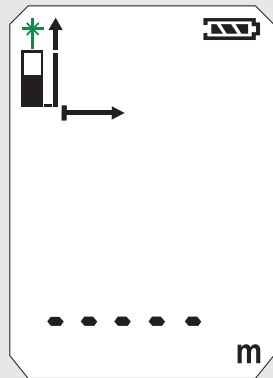

1

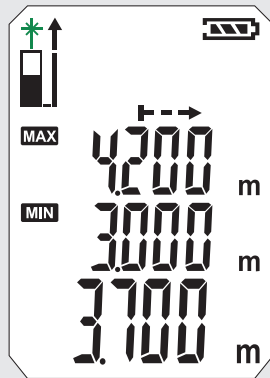
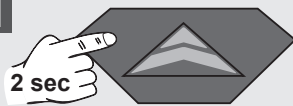

2

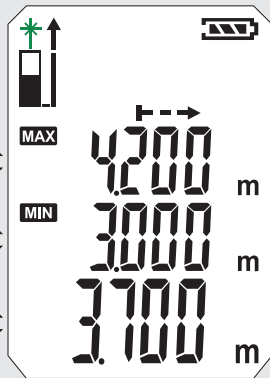

3

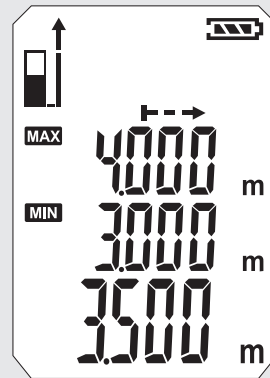
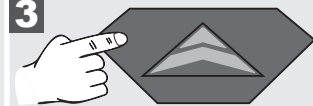

4

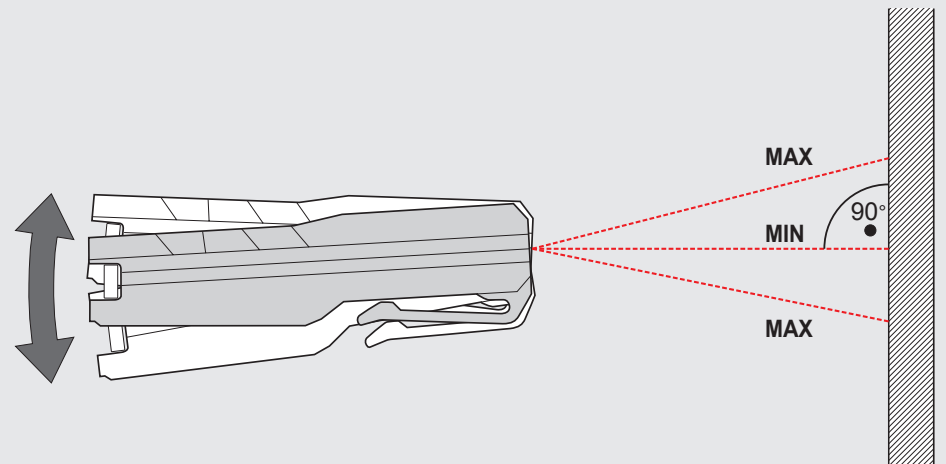
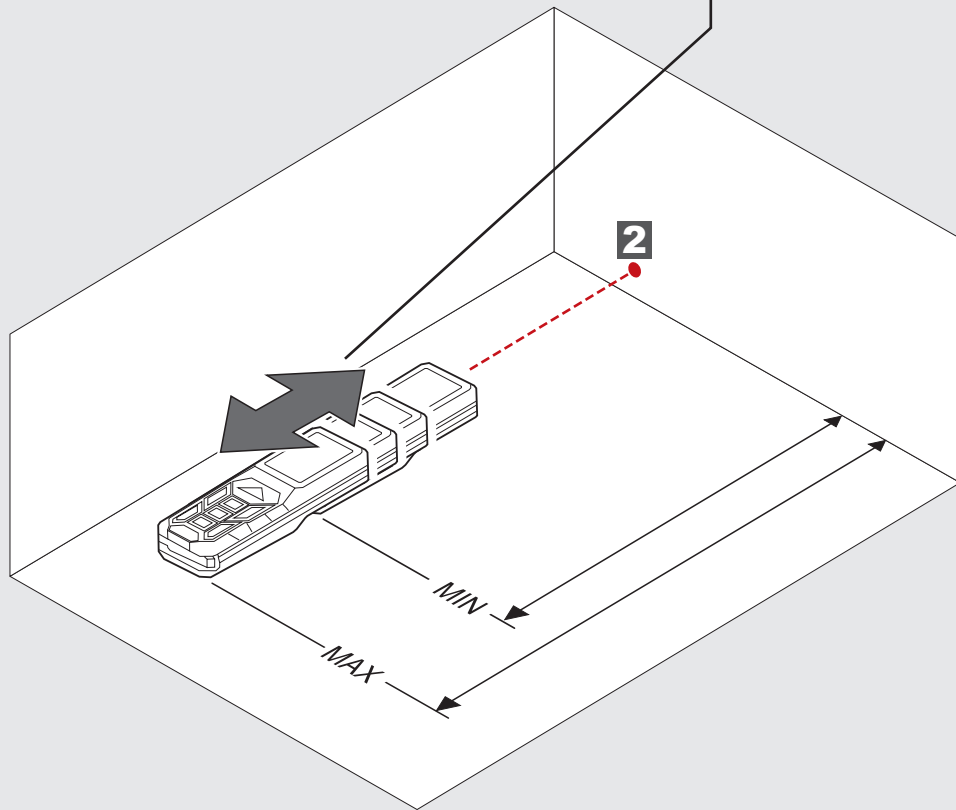
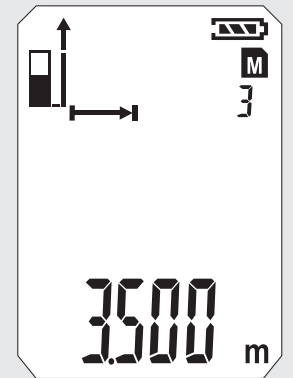
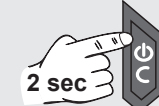

0

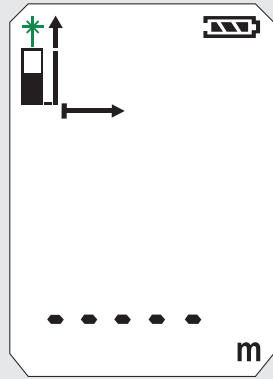

1

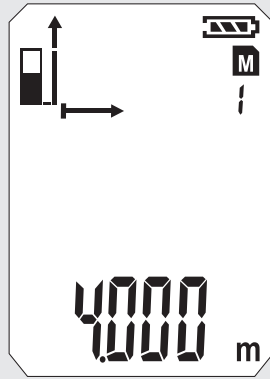
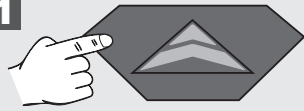

2

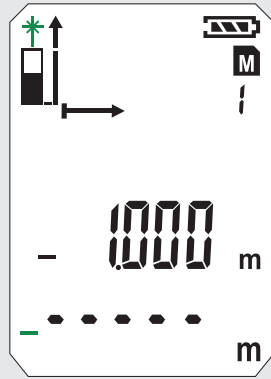
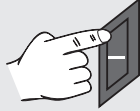

3

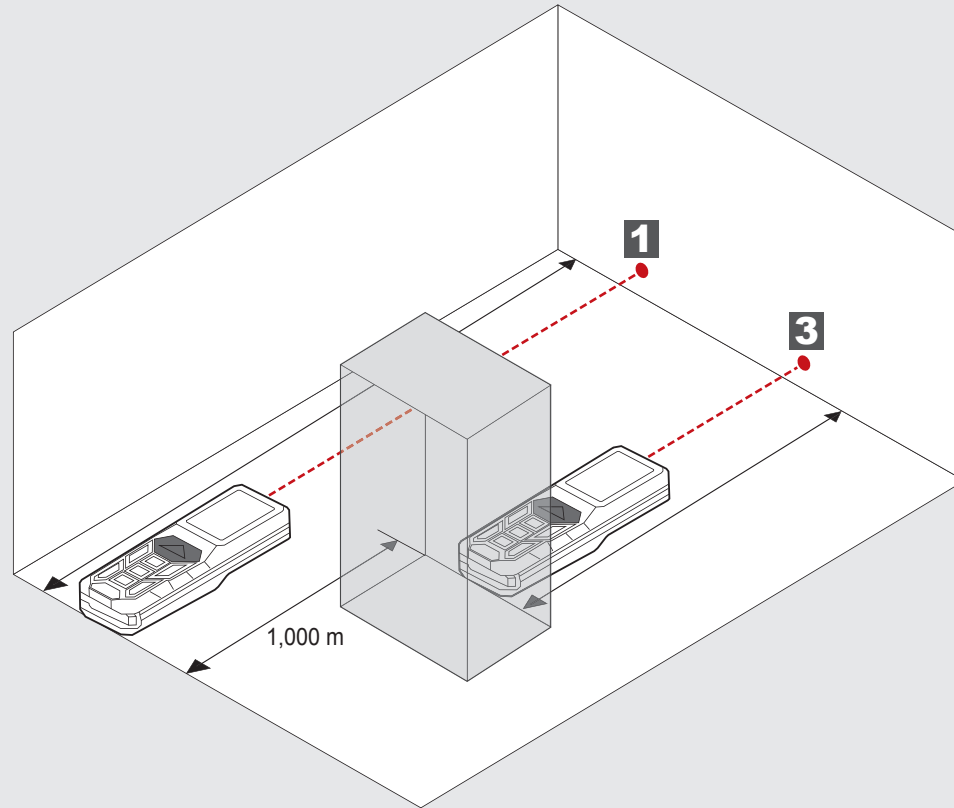
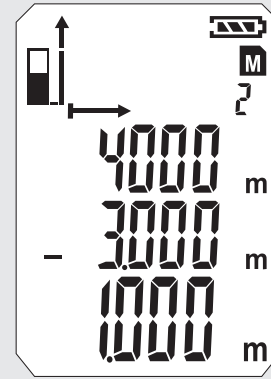
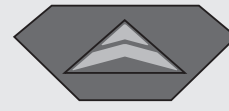

0



1

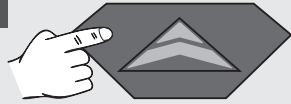

2

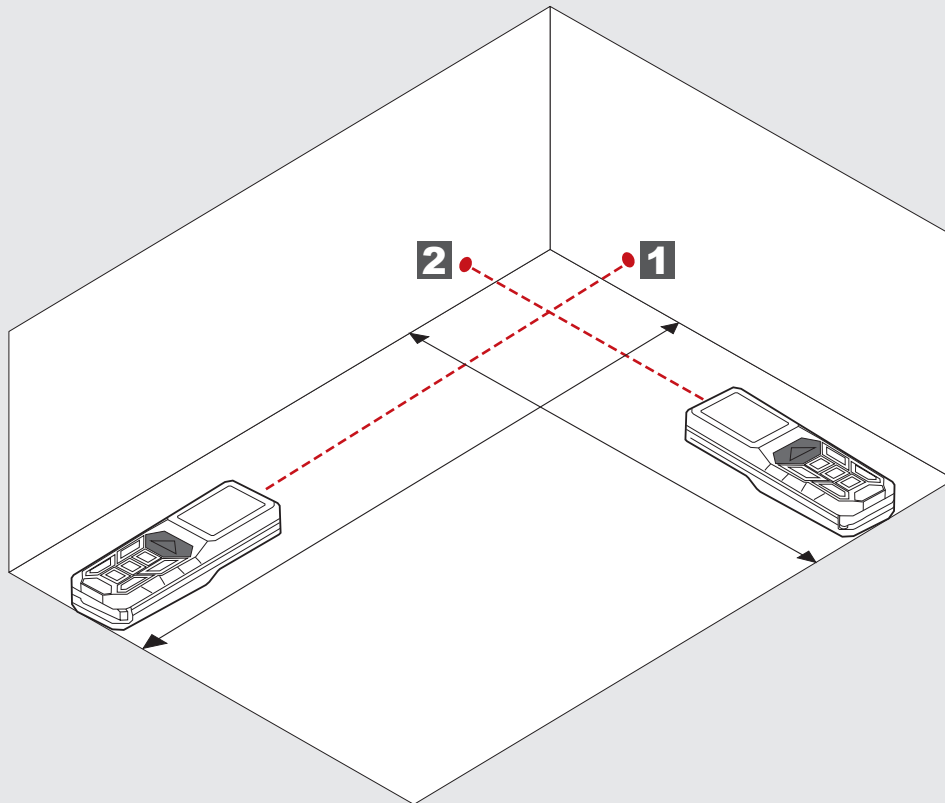
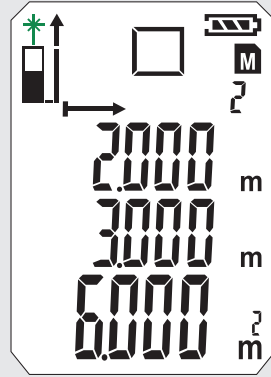
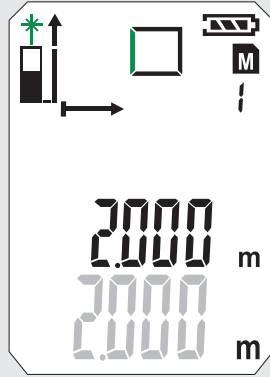
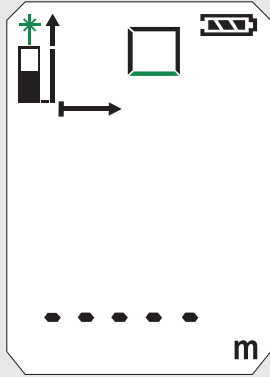
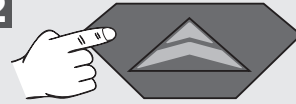

0



1

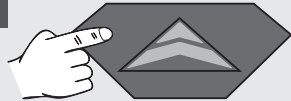

2

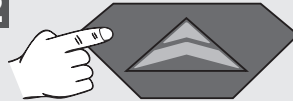

3

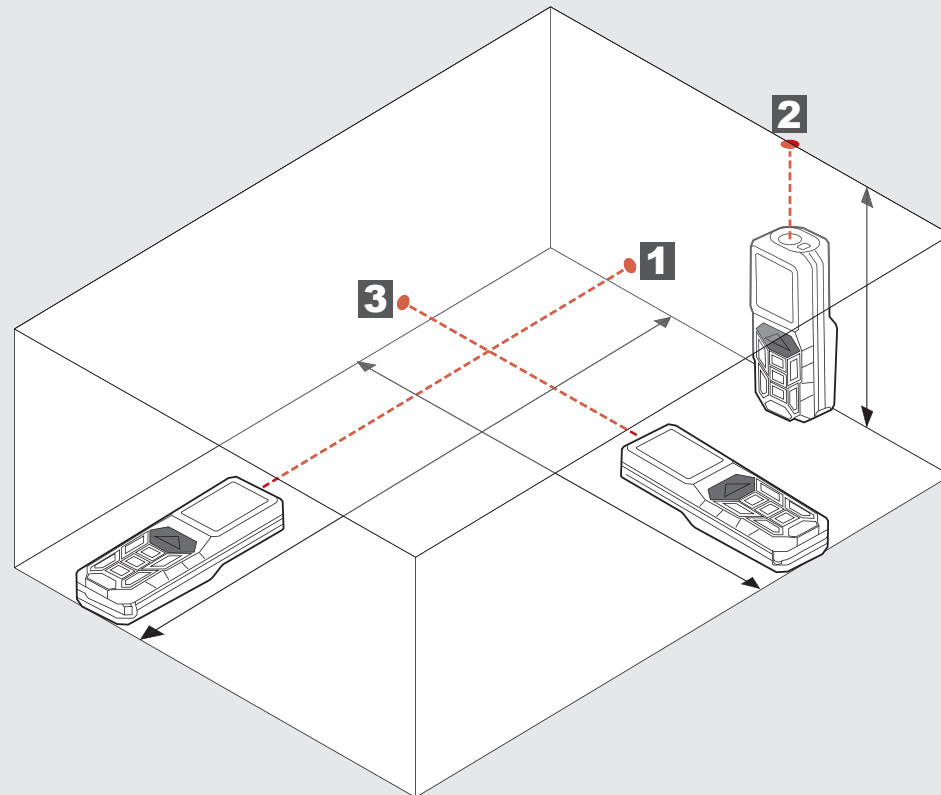
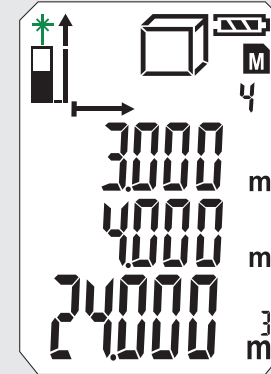
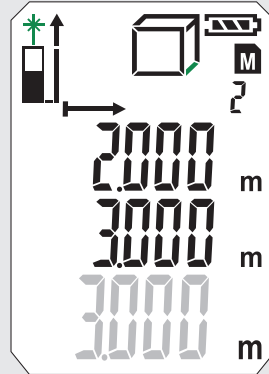
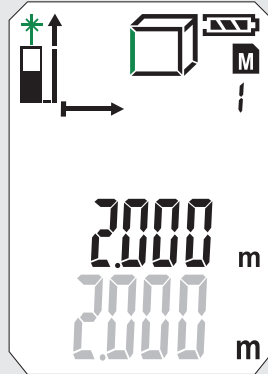
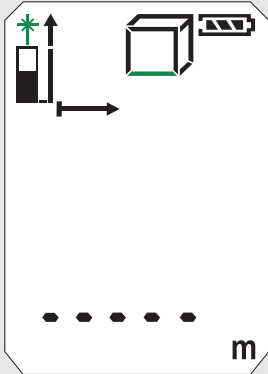
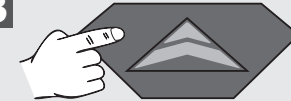

INDIREKTE MESSUNG (PYTHAGORAS 1)

0

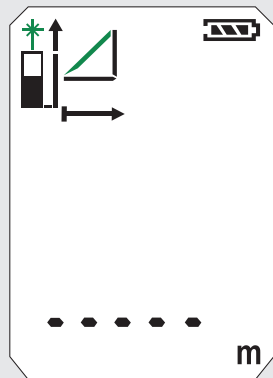

1

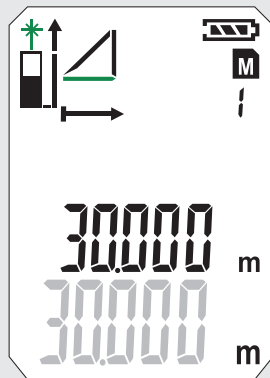
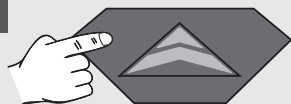

2

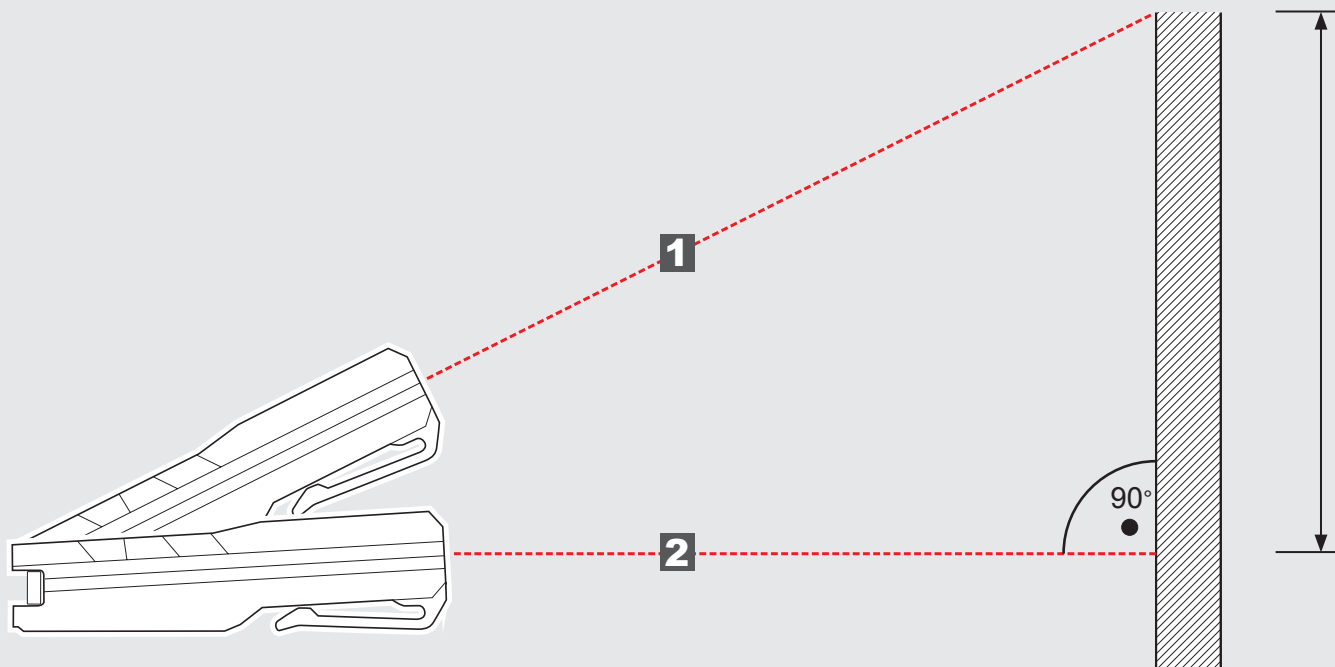
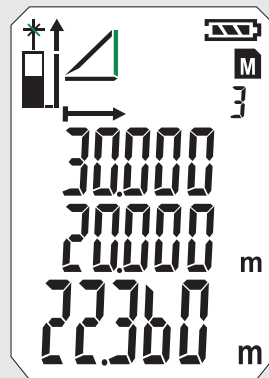

INDIREKTE MESSUNG (PYTHAGORAS 2)

0



1

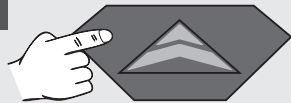

2

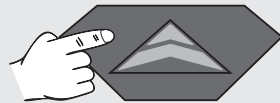

3

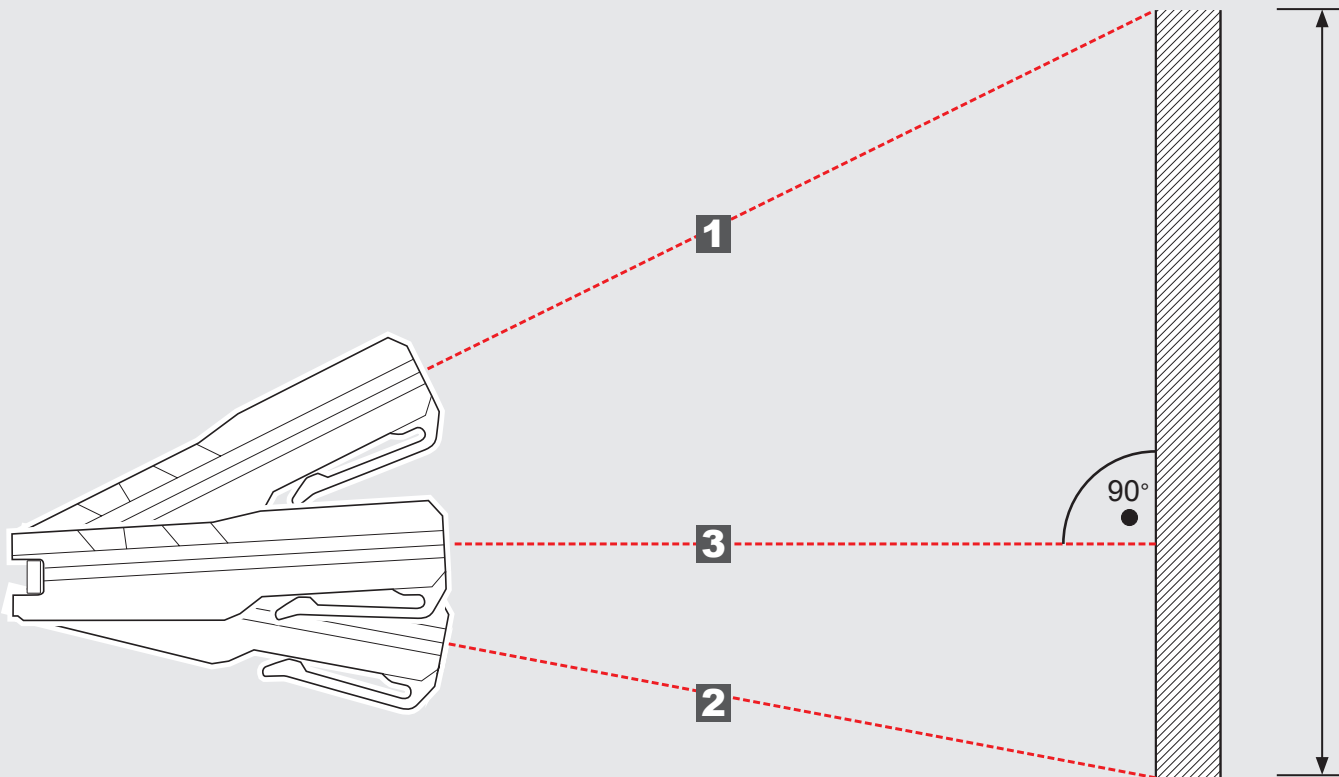
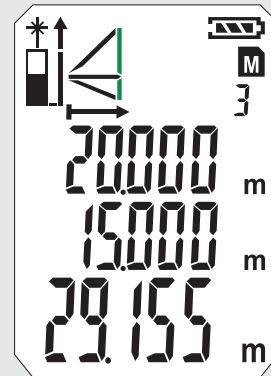
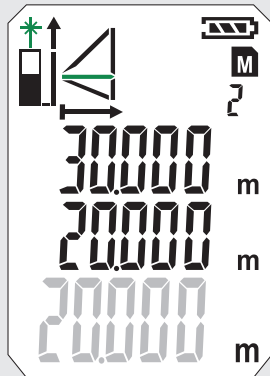
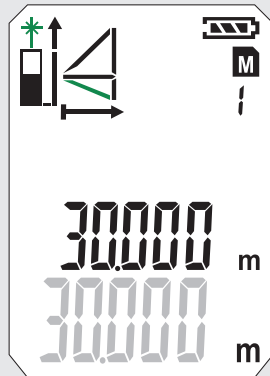
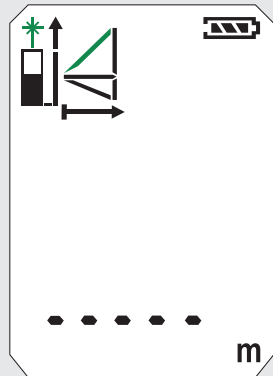
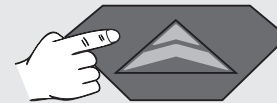

INDIREKTE MESSUNG (PYTHAGORAS 3)

1



2

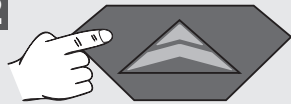

3

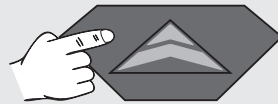

4

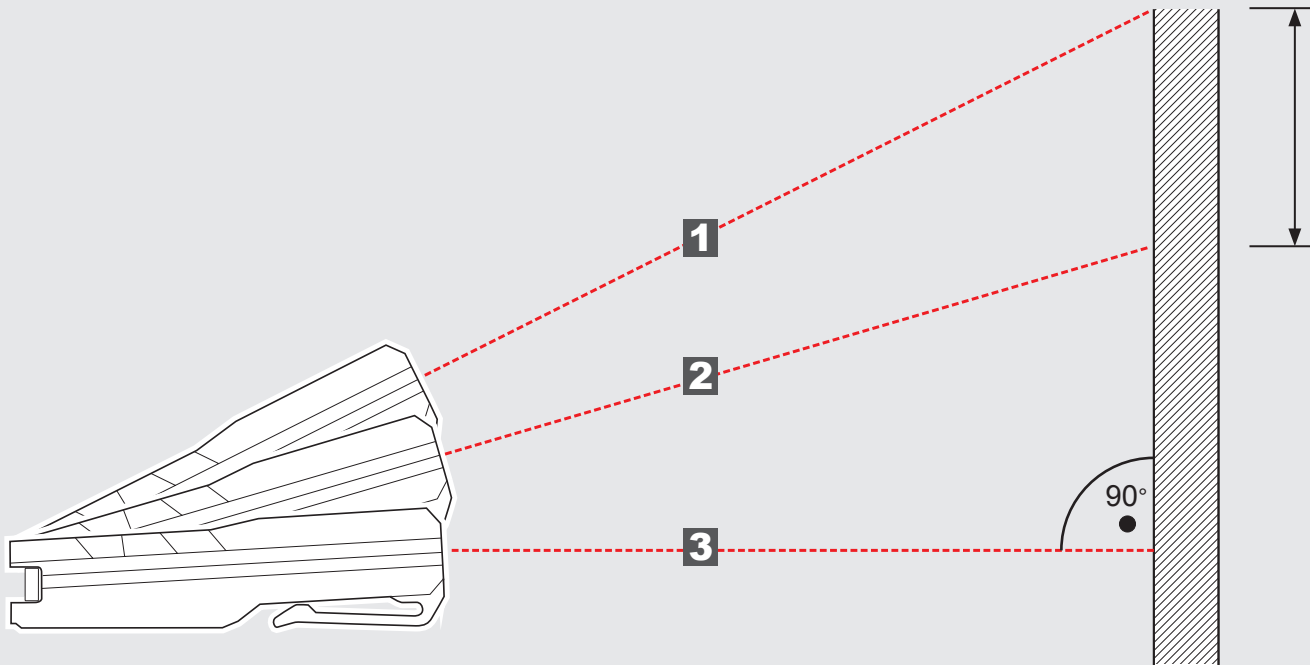
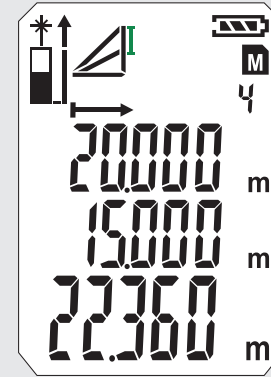
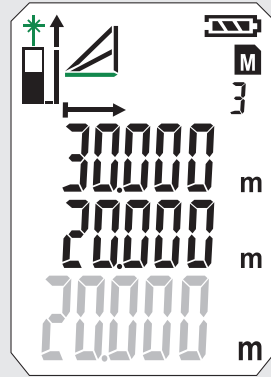
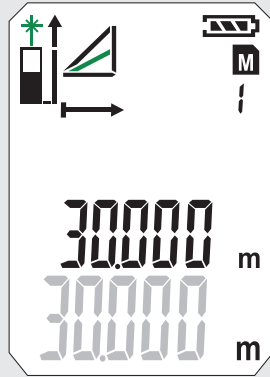
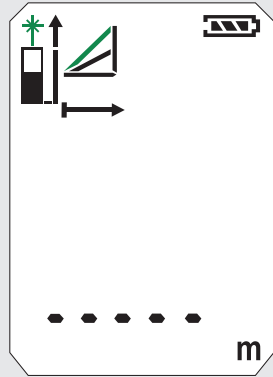
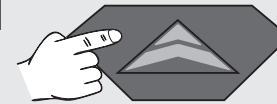

WANDFLÄCHENMESSUNG (SZENARIO 1)

<p>0</p>	<p>1</p>	<p>2</p>	<p>3</p>	<p>4</p>

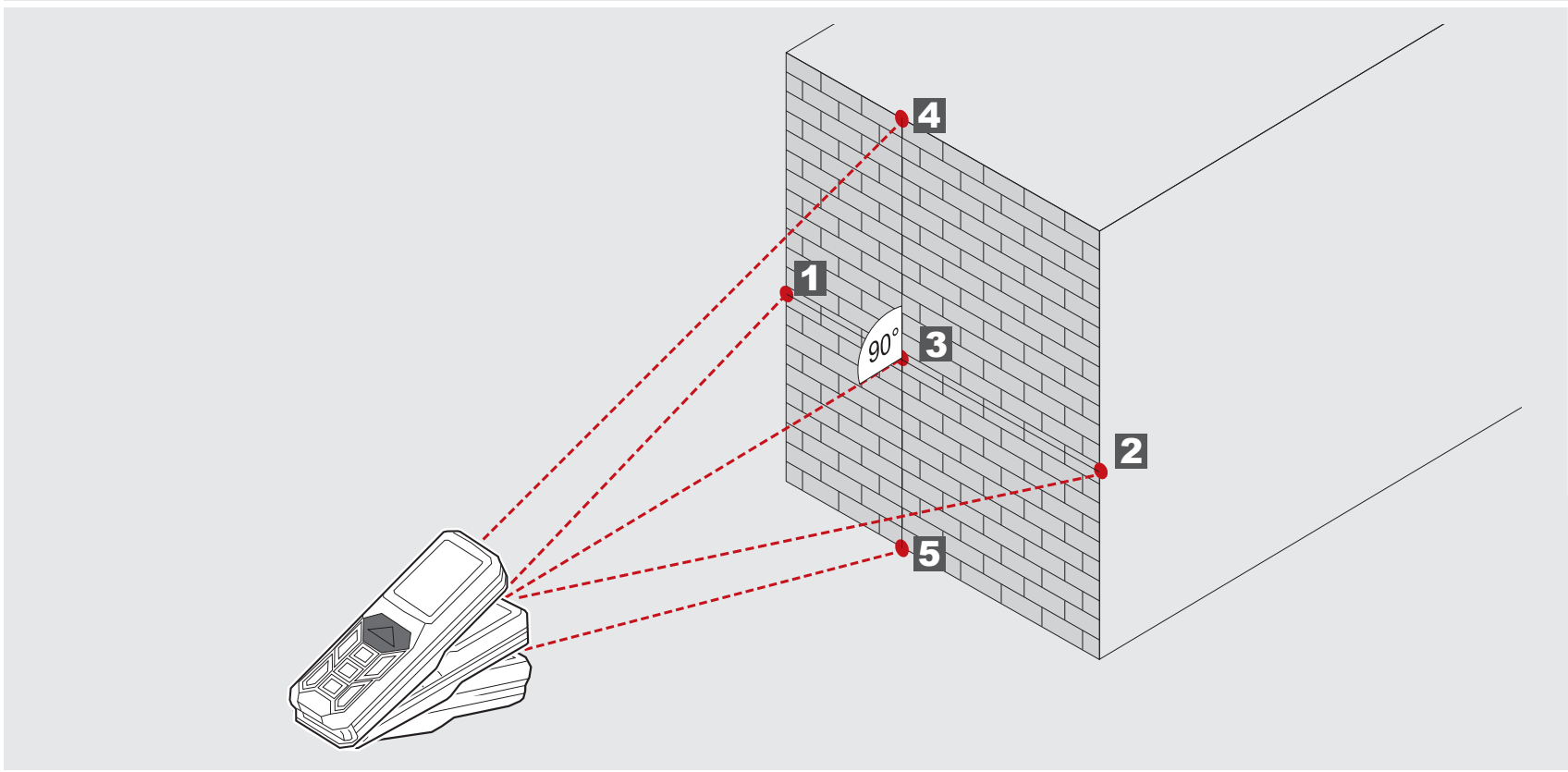

5

WANDFLÄCHENMESSUNG (SZENARIO 2)

0 	1 	2 	3 	4

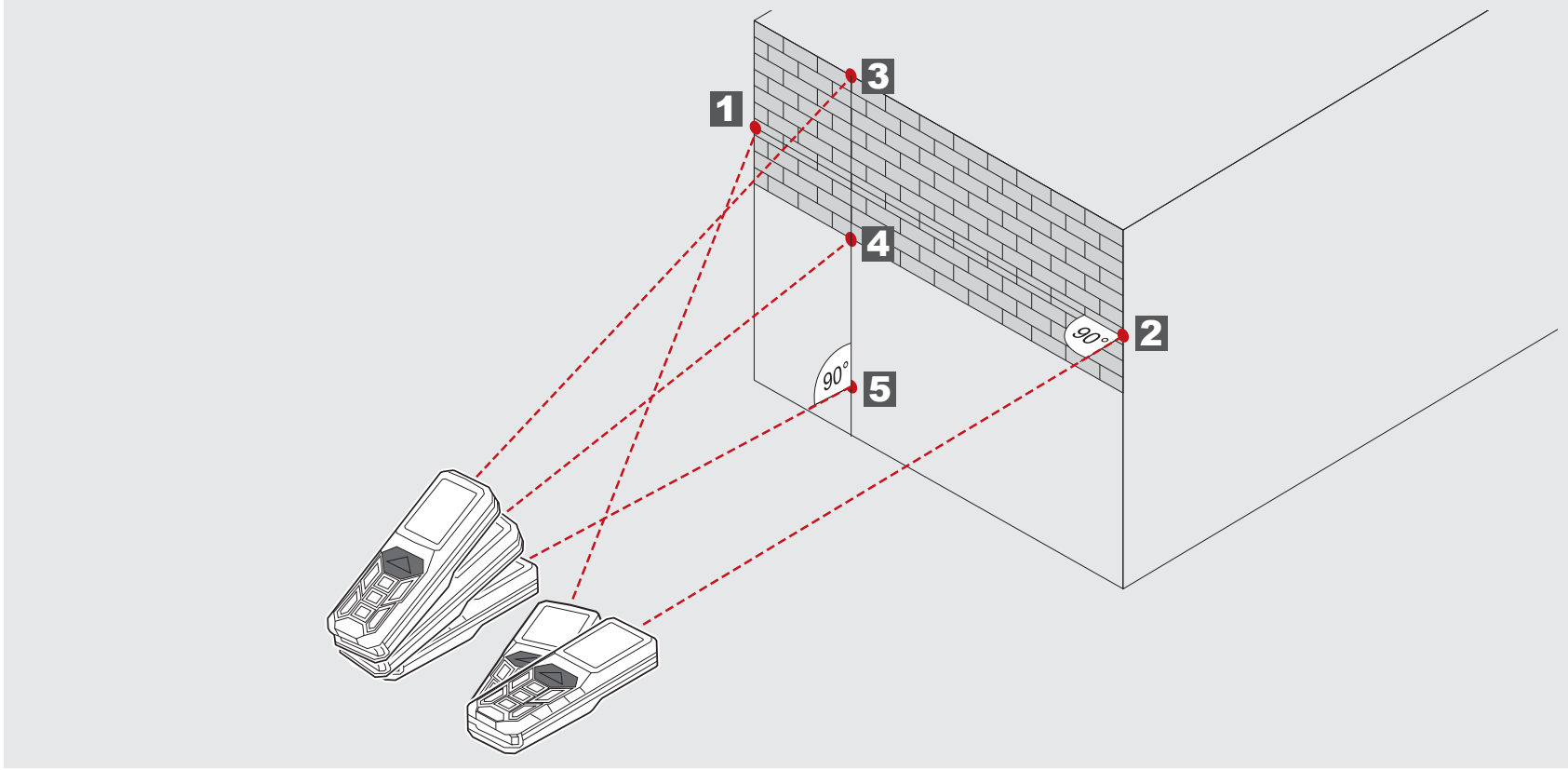

5

TIMER

Mit dem Timer kann die Messung verzögert ausgelöst werden, um z. B. ein Bauteil im Messstrahl zu positionieren.

Taste  drücken

- Symbol erscheint
- Durch Drücken der Taste  kann der Timer zwischen 3 und 15 sek eingestellt werden.

Taste  drücken

- Die Sekunden werden bis zur Messung heruntergezählt.
- Bei 0 wird die Messung ausgelöst.

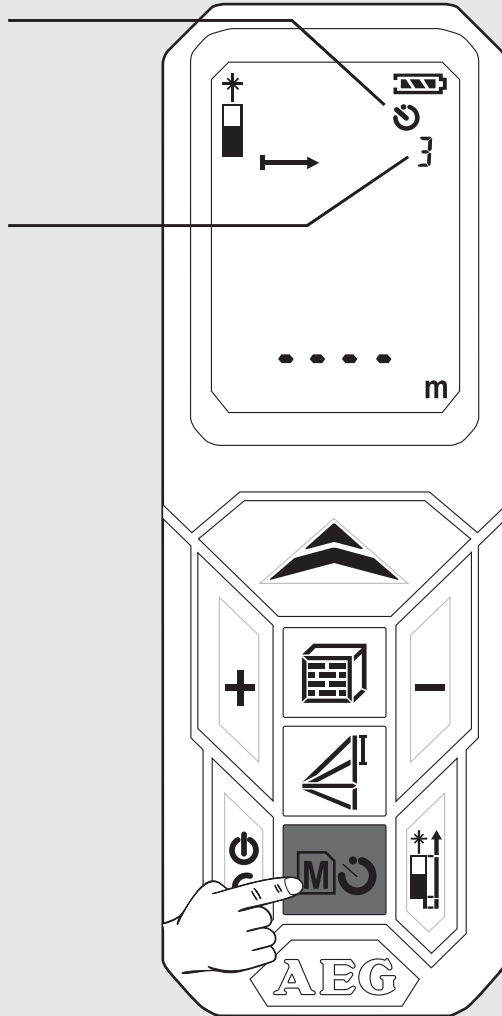

SPEICHER

Die Messwerte werden automatisch fortlaufend im Speicher abgelegt.

Die gespeicherten Werte können mit der Taste  abgerufen werden.

Taste  2 sek drücken

- Symbol und Speicherplatz erscheint.
- Zugehörige Messgröße wird angezeigt.
- Gespeicherter Wert wird in der Hauptzeile angezeigt.
- Mit den +/- Tasten navigieren

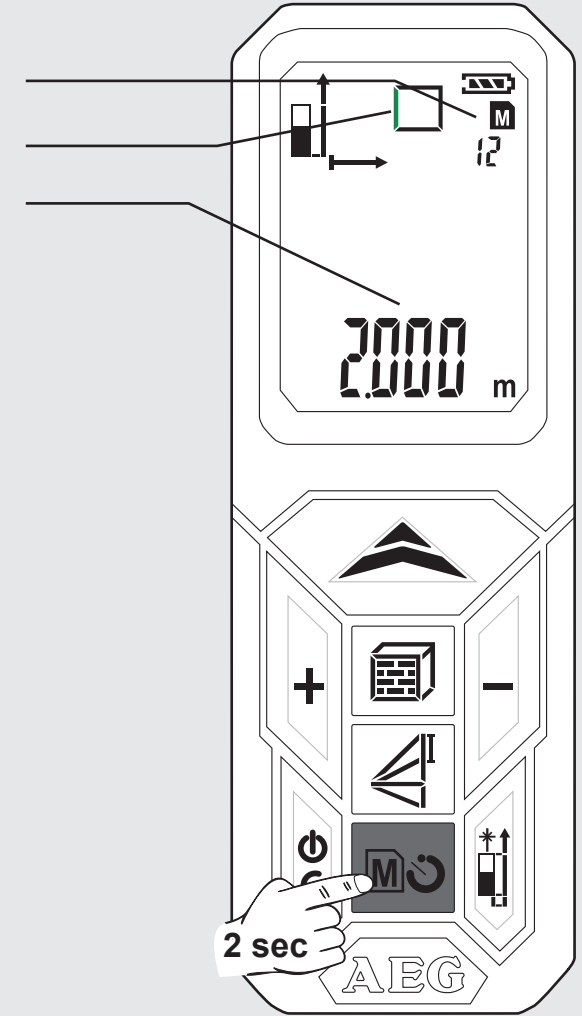

GRUNDLEGENDE FUNKTIONSWEISE AM BEISPIEL EINER FLÄCHENMESSUNG (1)



1 Einschalten

Taste  drücken.

Achtung! Laserstrahl an!
Nicht auf Personen richten!

2 Messebene wählen

Standardeinstellung nach dem Einschalten: hinten

 1x drücken -> Eckenstift
 2x drücken -> vorn
 3x drücken -> hinten

3 Funktion wählen

Nach dem Einschalten steht das Gerät immer auf Längenmessung.
 1x drücken - Flächenmessung

4 Länge messen

Gerät ausrichten und Taste  drücken

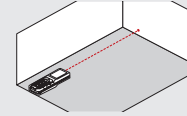

5 Breite messen

Gerät ausrichten und Taste  drücken

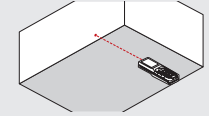

Lasersymbol blinkt (blinken grün dargestellt).

Symbol wird angezeigt

- Symbol erscheint
- Messgröße blinkt (blinken grün dargestellt)

- Messwert erscheint kurz in der Hauptzeile.
- Messwert springt nach 1 sek in darüberliegende Zeile.
Messwert wird im Speicher unter fortlaufender Nummer abgelegt.
Zweite Messgröße blinkt.
Gerät bereit für Messung des zweiten Wertes.

- Messwert erscheint kurz in der Hauptzeile.
- Messwert springt nach 1 sek in darüberliegende Zeile.
Messwert wird im Speicher unter fortlaufender Nummer abgelegt.
- Ergebnis wird in Hauptzeile angezeigt und im Speicher unter fortlaufender Nummer abgelegt.

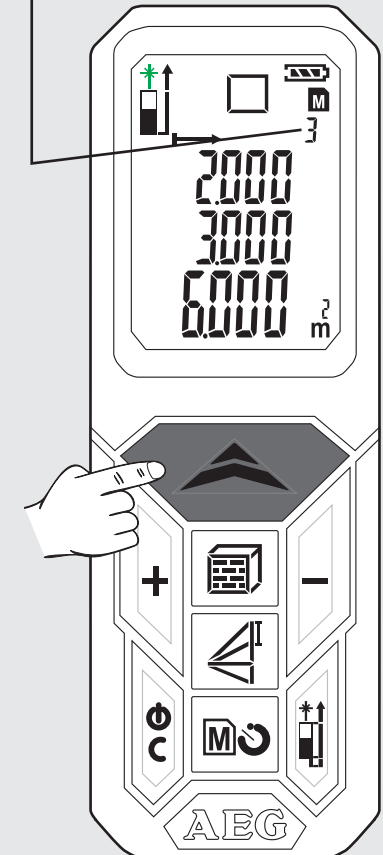
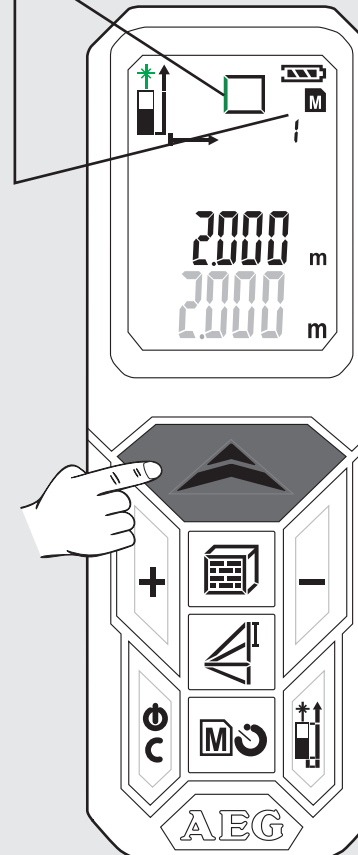
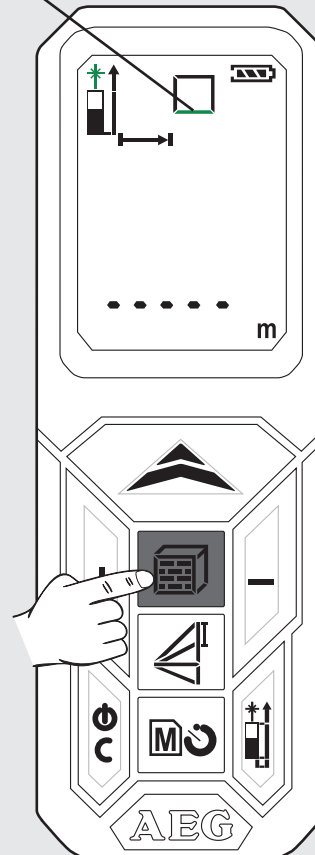
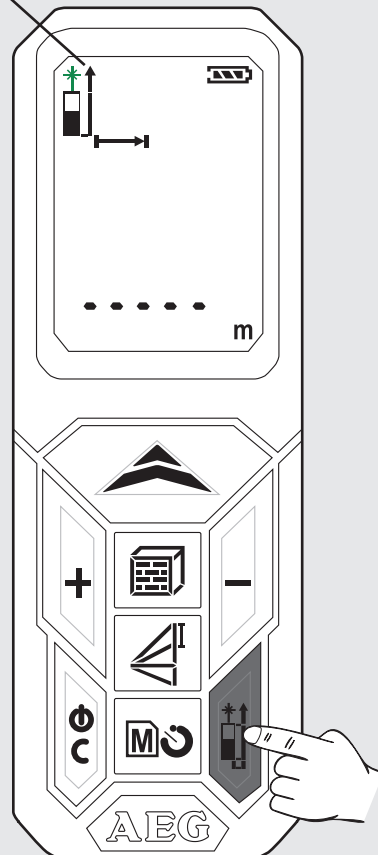
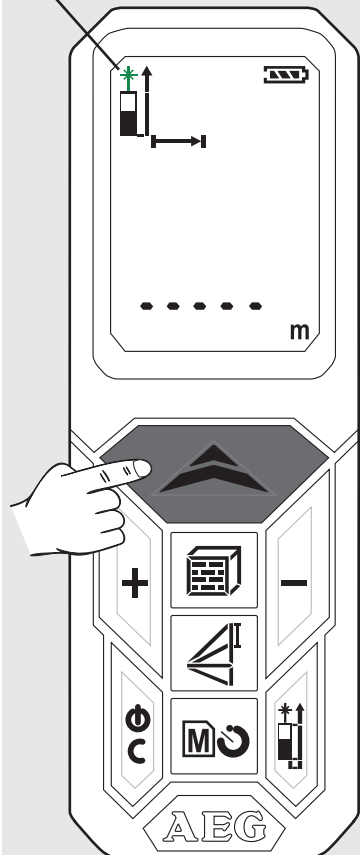

GRUNDLEGENDE FUNKTIONSWEISE AM BEISPIEL EINER FLÄCHENMESSUNG (2)

6 Gespeicherte Werte abrufen

Taste  2 sek drücken.
Taste + oder - drücken

7 Speicher verlassen

Taste  drücken

8 Ausschalten

Taste  2 sek drücken
(Speicher muss vorher verlassen werden).

- Gespeicherte Werte werden in der Hauptzeile angezeigt.
- Das zugehörige Symbol wird angezeigt und die Messgröße blinkt (blinken grün dargestellt).

- Das Gerät schaltet ab.
- Wenn 3 Minuten lang keine Taste gedrückt wird, schaltet sich das Gerät automatisch ab.

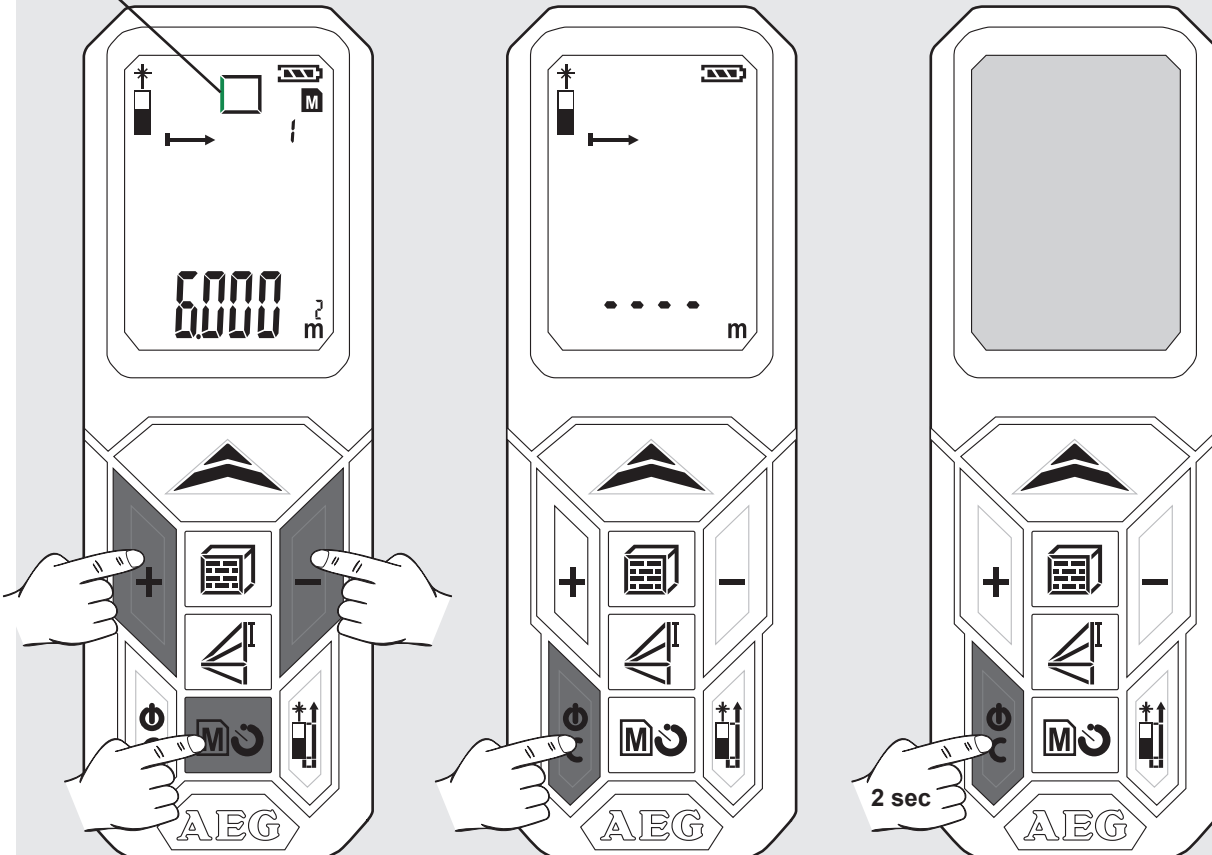



TABLE DES MATIÈRES

- Consignes de sécurité importantes1
- Caractéristiques techniques2
- Utilisation conforme aux prescriptions.....2
- Tables codes erreurs2
- Panoramique3
- Remplacement batterie4
- Pointe multifonctions4
- Clip à ceinture.....4
- Touche fonction, Pythagore, plan de mesure5
- Mesure longueur simple6
- Mesure continu / mesure min. / max.7
- Mesure par addition / soustraction8
- Mesure surface.....9
- Mesure volume10
- Mesure indirecte (Pythagore 1)11
- Mesure indirecte (Pythagore 2)12
- Mesure indirecte (Pythagore 3)13
- Mesure surface paroi (scène 1).....14
- Mesure surface paroi (scène 2).....15
- Timer16
- Mémoire.....16
- Fonctionnement de base exemplifié pour la mesure de la surface (1).....17
- Fonctionnement de base exemplifié pour la mesure de la surface (2).....18

CONSIGNES DE SÉCURITÉ IMPORTANTES

  N'utilisez pas ce produit avant d'avoir lu les consignes de sécurité et le manuel de l'utilisateur chargés sur le CD joint.

Classement laser

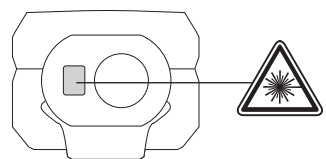

AVERTISSEMENT:
Ce produit fait partie de la classe laser 2 au sens de la norme CEI 60825-1:2007.



Plaquette autocollant

Avant la première mise en service, collez l'autocollant livré dans votre langue nationale sur le texte anglais de la plaquette signalétique.

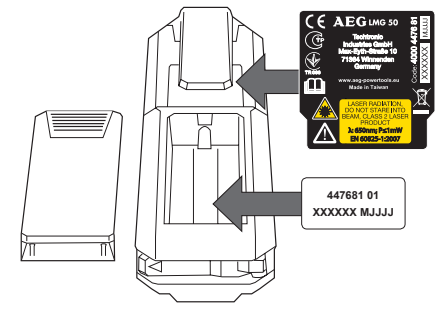

Avis :
Éviter tout contact visuel direct. Le rayon laser peut causer un aveuglement temporaire type flash aux yeux.

Ne regardez pas dans le faisceau laser et ne le dirigez pas inutilement sur d'autres personnes.

N'éblouissez pas d'autres personnes.

Avis :
Ne pas employer le dispositif au laser près des enfants et ne pas permettre aux enfants d'employer le dispositif au laser

Attention ! Des surfaces réfléchissantes pourraient réfléchir le rayon laser sur l'opérateur ou sur des autres personnes.

Se tenir à distance des pièces en mouvement.
Effectuez régulièrement des mesures d'essai, en particulier avant, pendant et après des mesures importantes.

Attention: si le produit est défectueux, est tombé, a été utilisé de manière non conforme ou modifié, il peut fournir des mesures incorrectes

Attention ! Familiarisez-vous avec les éléments de commande et l'utilisation appropriée de l'outil de jardin.

Le dispositif de mesure laser a une plage d'application limitée. (Voir chapitre "Données techniques"). Tout essai de mesure hors de la plage max. ou min. produira des résultats imprécis. L'utilisation en présence de conditions atmosphériques défavorables, telles que températures très hautes ou très basses, lumière solaire très intense, pluie, neige, brouillard ou toute autre condition limitant la visibilité, pourra comporter des mesures imprécises.

Si le dispositif de mesure laser est déplacé d'un site chaude à un site froid (ou vice-versa) il faut attendre pour permettre au dispositif de s'adapter à la nouvelle température ambiante.

Conserver toujours le dispositif de mesure laser dans un endroit fermé et le protéger contre les chocs, les vibrations et les températures extrêmes.

Protéger le dispositif de mesure laser contre les poussières, les liquides et la haute humidité de l'air. Les facteurs susdits pourraient endommager gravement les composants internes ou influencer négativement sa précision.

Ne pas utiliser des détergents agressifs ou des solvants. Nettoyer uniquement avec un chiffon propre et doux.

Éviter de forts chocs sur le dispositif de mesure laser ou sa chute. Après une chute du dispositif de mesure laser ou après son exposition à d'autres sollicitations mécaniques, il est nécessaire de contrôler la précision du dispositif.

Les réparations éventuellement nécessaires sur le dispositif au laser sont à effectuer exclusivement par du personnel spécialisé autorisé !

N'utilisez pas le produit dans des zones à risque d'explosion ou dans des environnements agros- sifs.

Recharger seulement les batteries avec les chargeurs recommandés par le fabricant.

 Ne pas jeter les batteries déchargées avec les ordures ménagères. Les amener à un point de collecte prévu à cet effet pour une élimination conforme aux prescriptions environnementales nationales ou locales. Ne pas jeter le produit avec les ordures ménagères. Eliminer le produit conformément aux prescriptions nationales en vigueur dans le pays d'utilisation. Suivre les règles de recyclage en vigueur sur le plan national, spécifiques au produit. Contactez les autorités locales ou le détaillant pour avoir des renseignements concernant la mise à la ferraille.



CARACTÉRISTIQUES TECHNIQUES

Classe de protection	IP54 (protection contre les poussières et les projections d'eau)
Optique	14 mm
Point focal	35 mm
Plage de mesure max.	50 mètres (tolérance: 55m)
Plage de mesure min.tab#0,05 mètres	0,05 Meter
Précision absolue @ < 10m	± 1,5 mm (max)
Précision de répétabilité @ < 10m	± 1,5 mm (typiquement max. 2σ)
Précision de répétabilité @ > 10m	montée± 0,25 mm / mètre (typiquement max. 2σ)
Temps de mesure	0,5 s
Afficheur type	LCD (22,7 mm x 31 mm)
Alimentation	AAA 2x (batterie alcaline)
Durée batterie	10000 (mesures individuelles)
Puissance de sortie laser	0,6 mW ~ 0,95 mW (Classe 2, 650nm)
Dimension point laser	25 x 30 mm @ 16 m (max)
Rayon laser angle vertical	+1 degré
Rayon laser angle horizontal	±1 degré
Coupure automatique dispositif	180 secondes
Coupure automatique laser	30 secondes
Plage température d'utilisation	de -10°C à +50°C
Plage température de stockage	de -25°C à +70°C
Poids sans batterie	80 g

UTILISATION CONFORME AUX PRESCRIPTIONS

Le dispositif de mesure laser est apte à mesurer des distances et des inclinaisons.

Comme déjà indiqué, cette machine n'est conçue que pour être utilisée conformément aux prescriptions.

TABLES CODES ERREURS

Code	Description	Solution
Err01	Hors de la plage de mesure	Mesurer dans la plage prévue.
Err02	Signal réfléchi trop faible	Choisir une surface plus appropriée.
Err03	Hors de la plage de visualisation (valeur max: 99.999) est par exemple le résultat d'une surface ou d'un volume hors de la plage de visualisation	Contrôler l'exactitude des valeurs et des pas.
Err04	Erreur dans le calcul de Pythagore	Contrôler l'exactitude des valeurs et des pas.
Err05	Batterie épuisée	Remplacer la batterie.
Err06	Hors de la plage de la température d'utilisation	Effectuer la mesure dans la plage prévue pour la température d'utilisation.
Err07	Éclairage excessif	Obscurcir la zone cible.

Pythagore
Différence hauteur

Plan de mesure

Mesure longueur

Min. / max. pour mesure continue

Addition / soustraction

Surface / volume
Mesure indirecte de la surface

Niveau batterie

Mémoire

Timer

Mesure continue

Valeurs intermédiaires

Valeur totale

ON / MESURER

- ▶ ON
- ▶ Mesurer
- ▶ Mesure continue (enfoncer pendant 2 sec)
Fonction min. / max.

ADDITION

- ▶ Addition valeur
- ▶ Navigation mémoire

SURFACE / VOLUME

- ▶ Surface (enfoncer 1x)
- ▶ Volume (enfoncer 2x)
- ▶ Mesure indirecte de la surface (enfoncer 3x / 4x)

ACTIVER

- ▶ ON
- ▶ Off (enfoncer pendant 2 sec)
- ▶ Reset

SOUSTRACTION

- ▶ Soustraction valeur
- ▶ Navigation mémoire

PYTHAGORE

- ▶ Pythagore 1 (enfoncer 1x)
- ▶ Pythagore 2 (enfoncer 2x)
- ▶ Pythagore 3 (enfoncer 3x)

CHANGE PLAN DE MESURE

- ▶ Antérieur
- ▶ Postérieur
- ▶ Pointe multifonctions

MÉMOIRE

- ▶ Timer 3-15 sec. (enfoncer 1x)
- ▶ Mémoire 1-20 (enfoncer 1x 2 sec.)
- ▶ Utiliser les touches +/- pour naviguer en mémoire

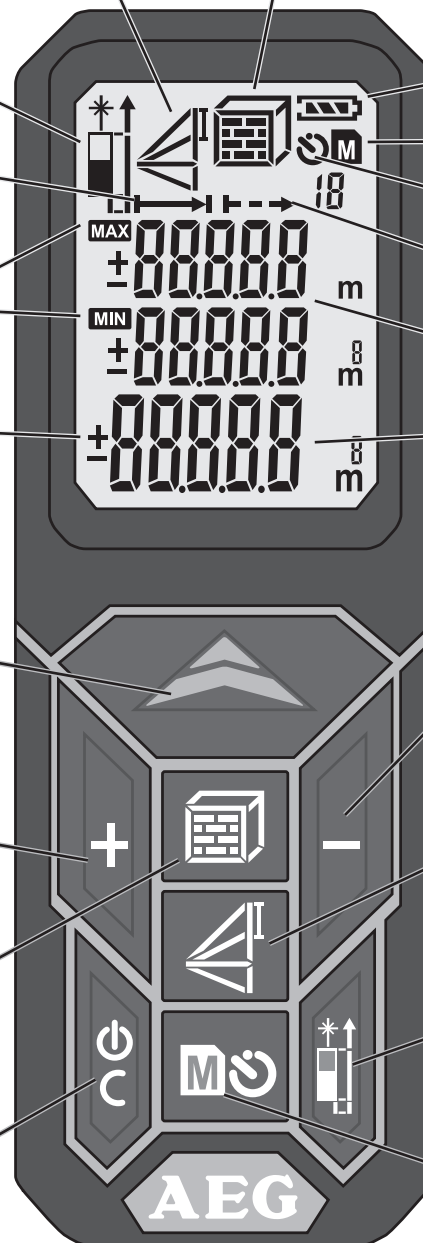

REPLACEMENT BATTERIE

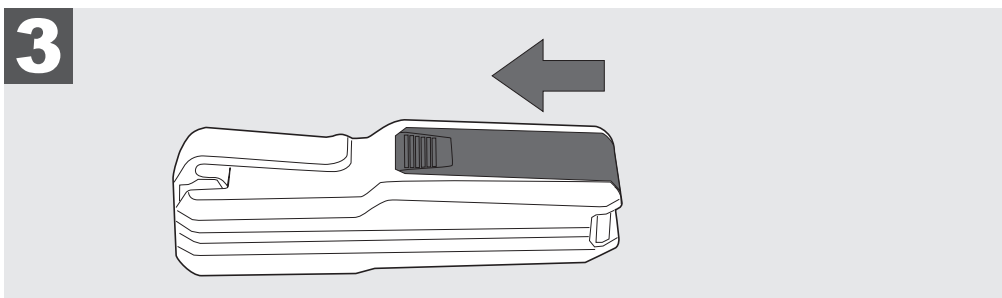
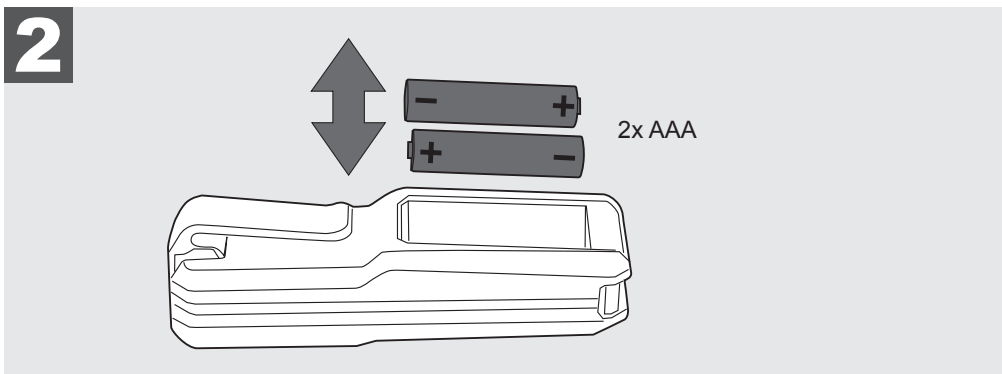
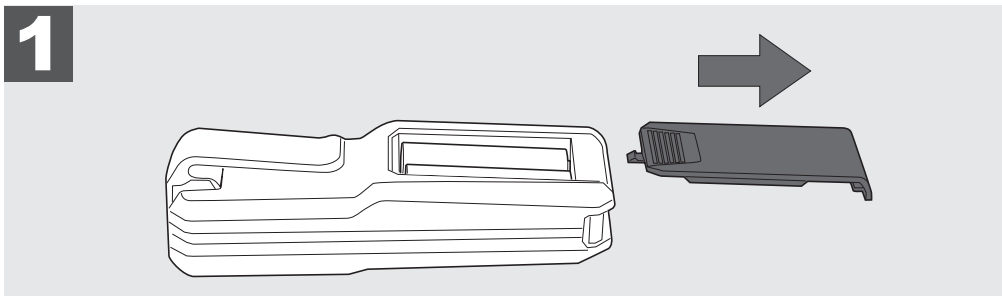
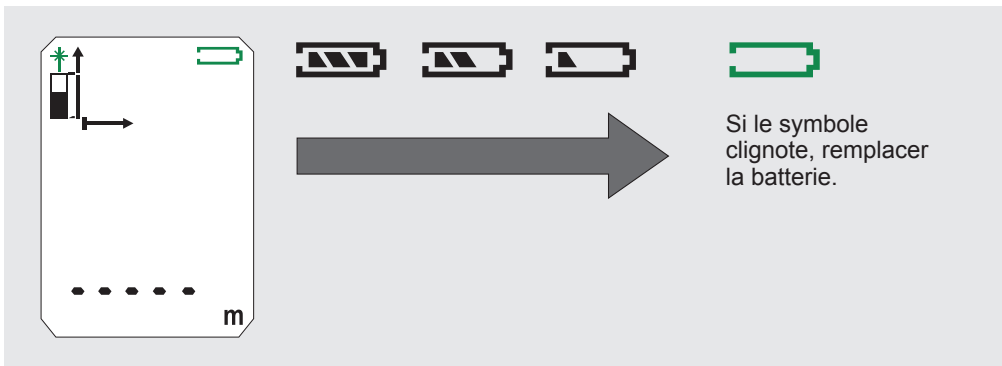

POINTE MULTIFONCTIONS

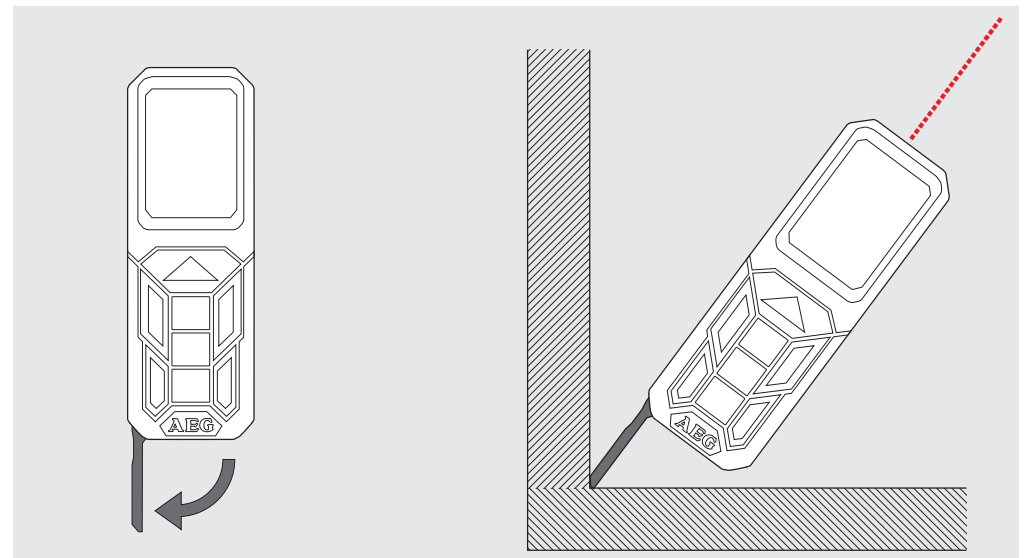

CLIP À CEINTURE

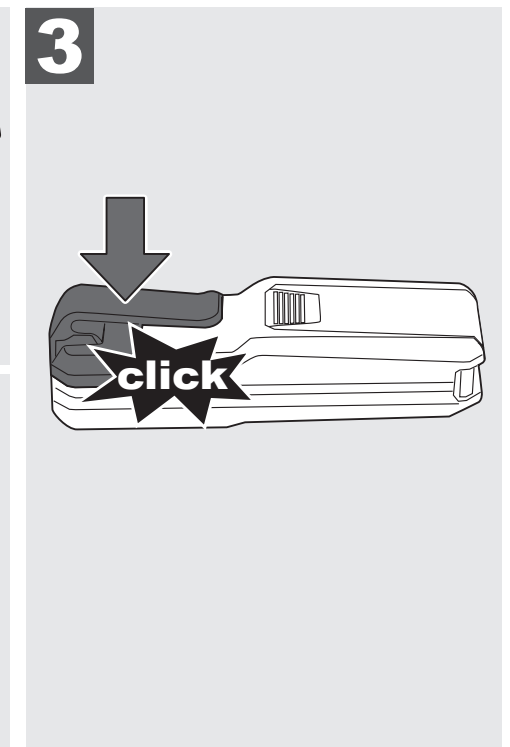
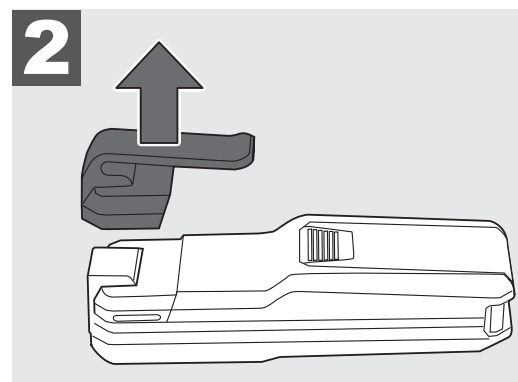
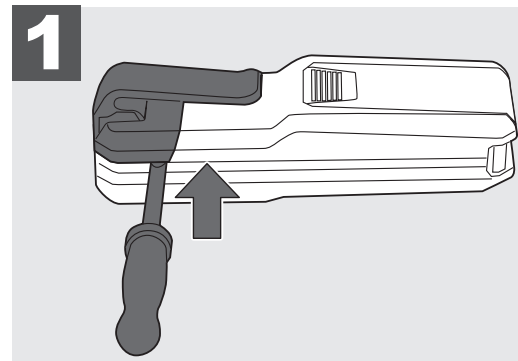

TOUCHE FONCTION, PYTHAGORE, PLAN DE MESURE

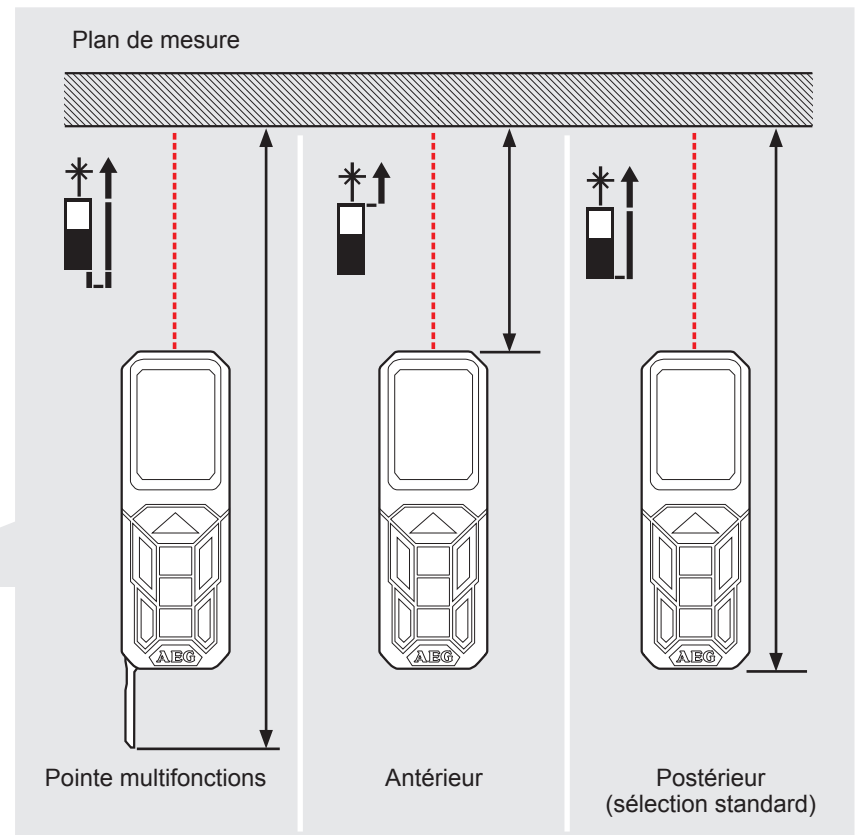
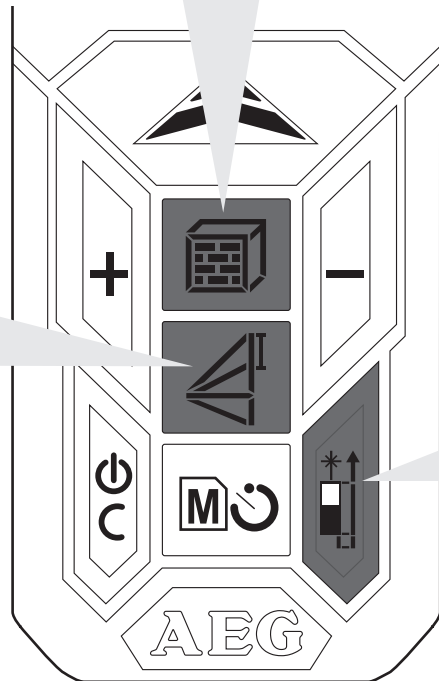
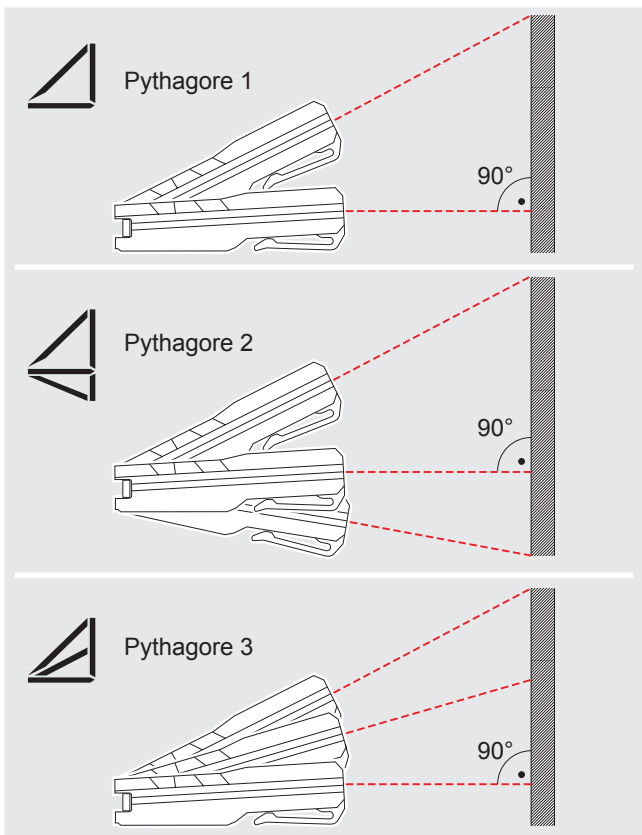
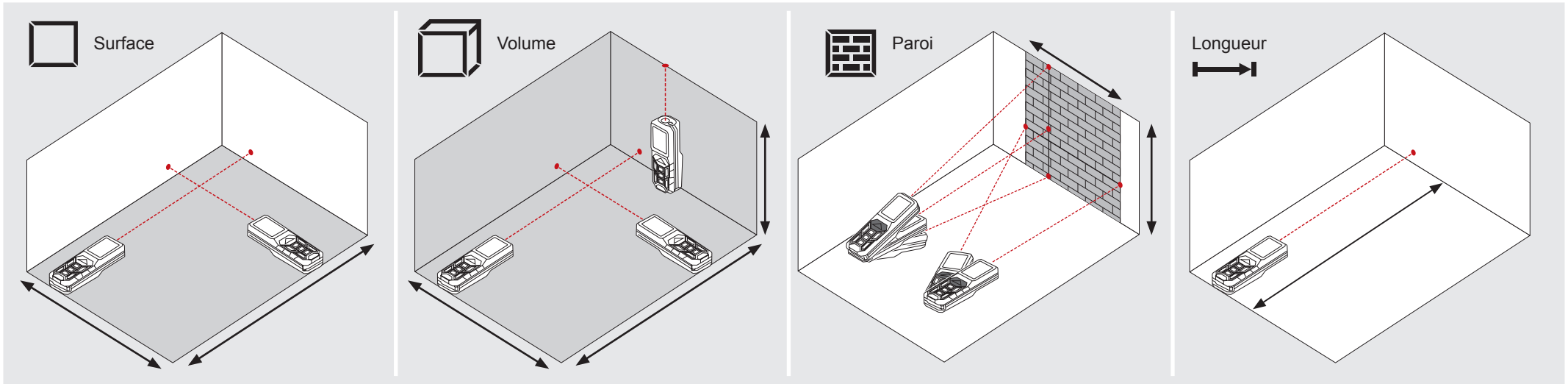

MESURE LONGUEUR SIMPLE

0

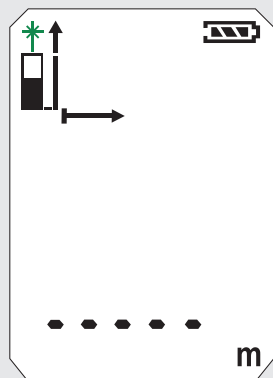

1

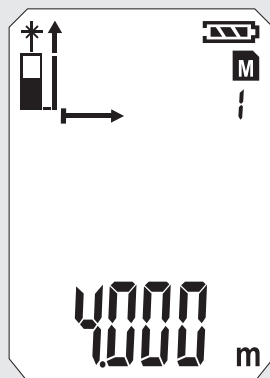
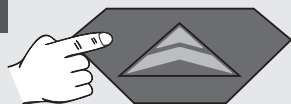

2

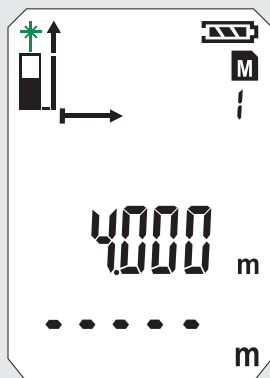
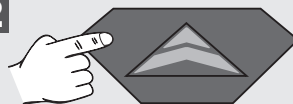

3

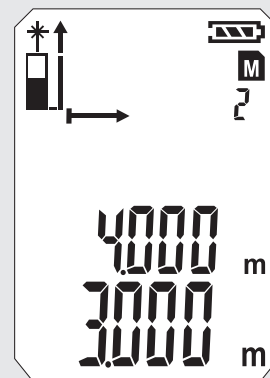
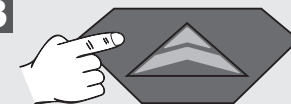

4

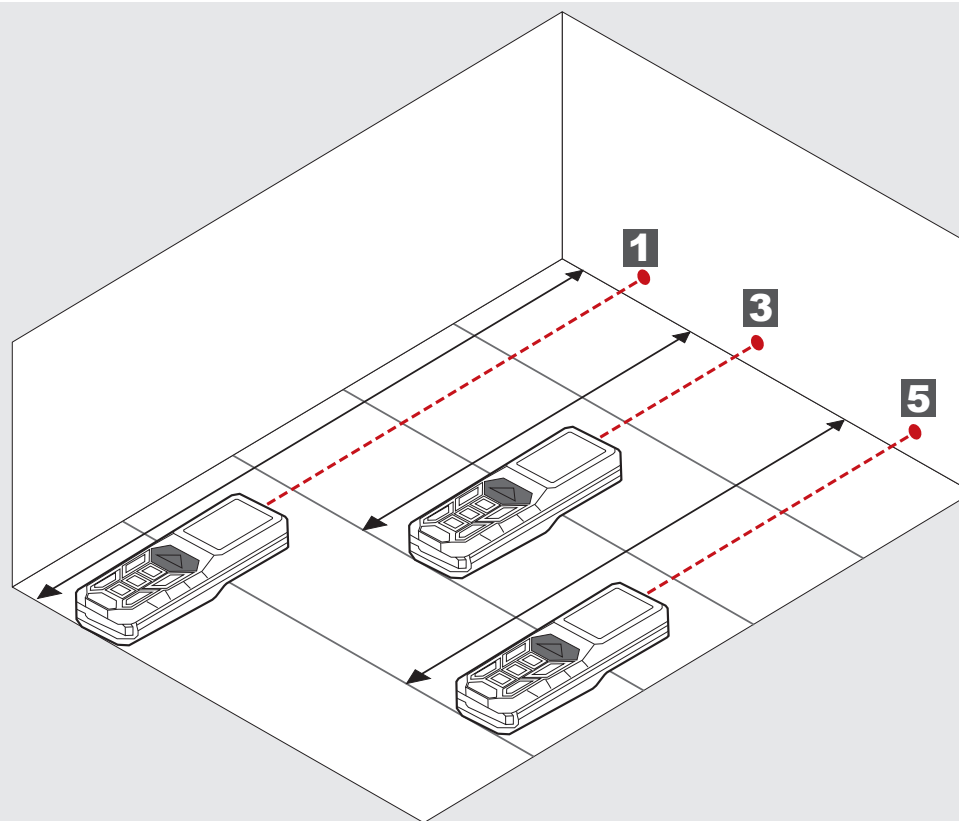
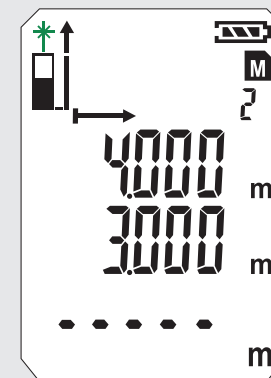
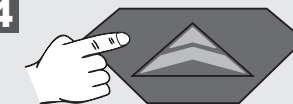

5

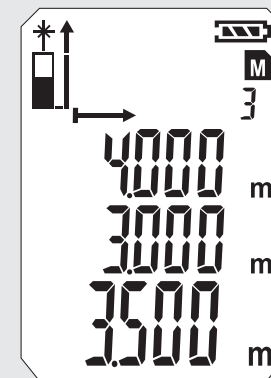
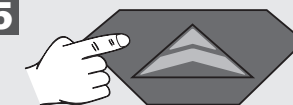

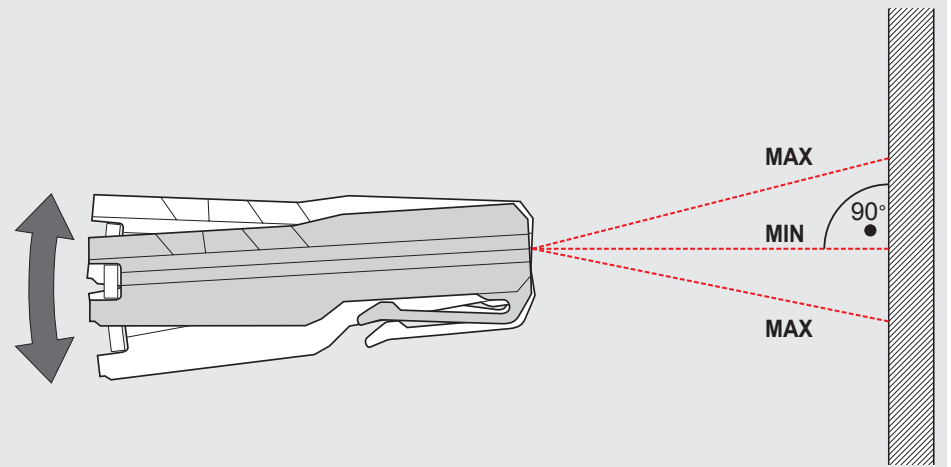
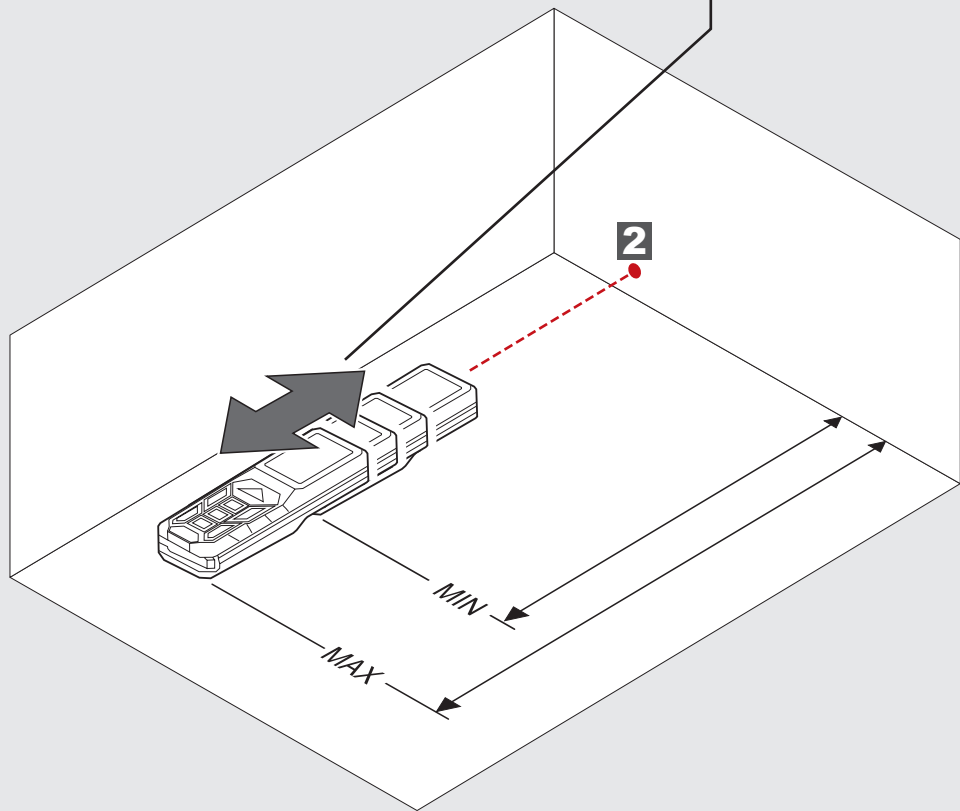
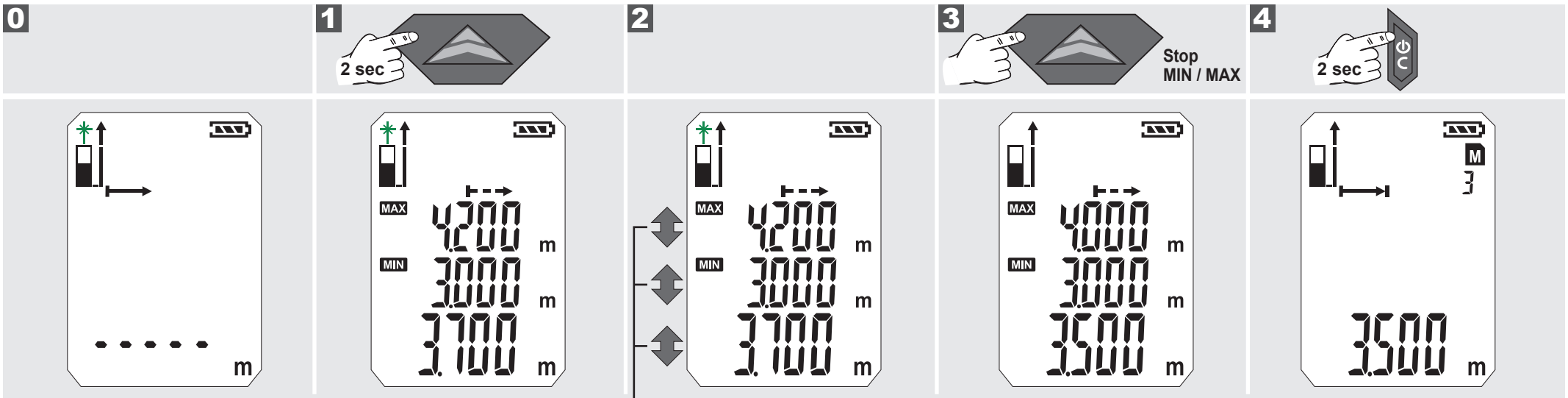

MESURE PAR ADDITION / SOUSTRACTION

0

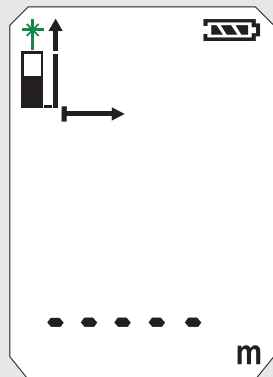

1

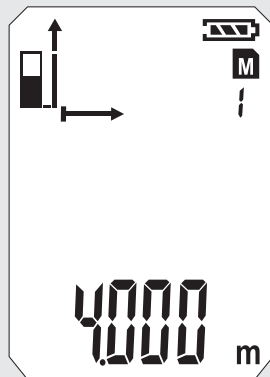
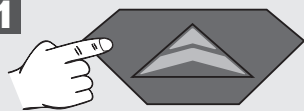

2

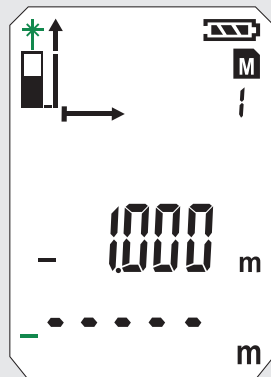
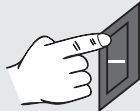

3

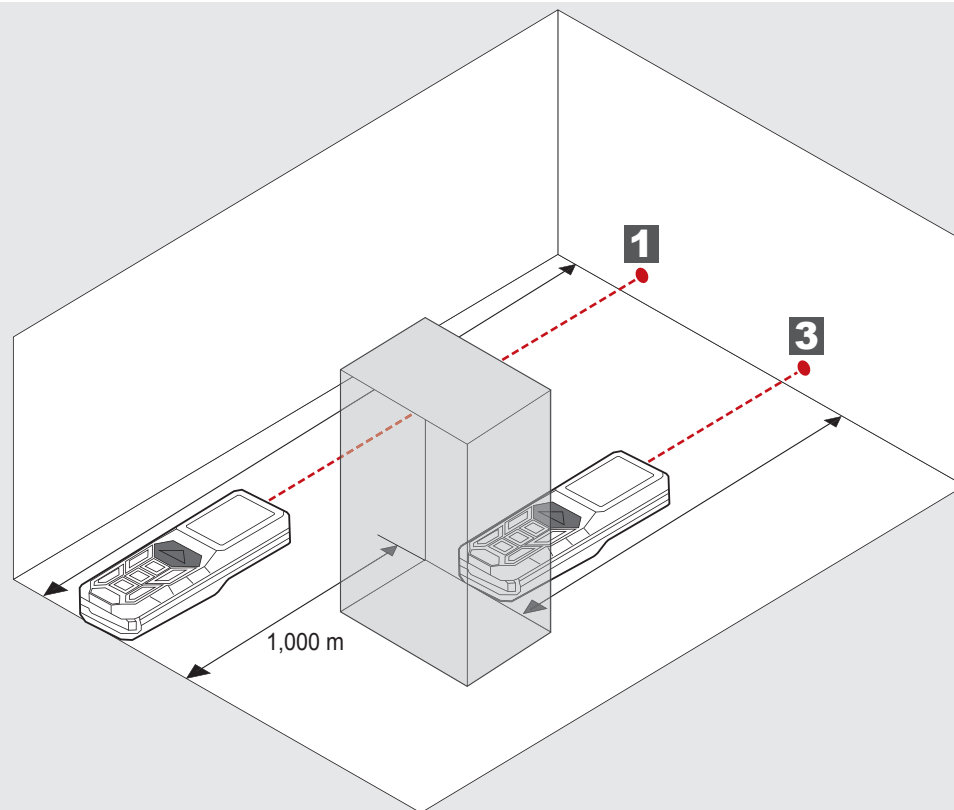
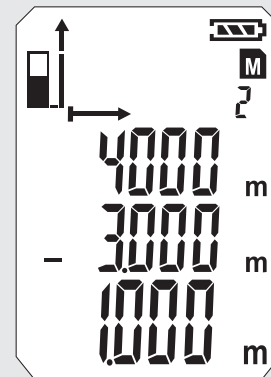
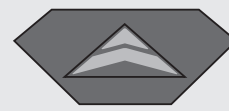

MESURE SURFACE

0

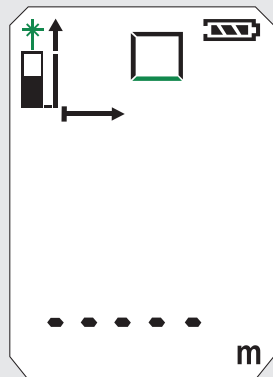

1

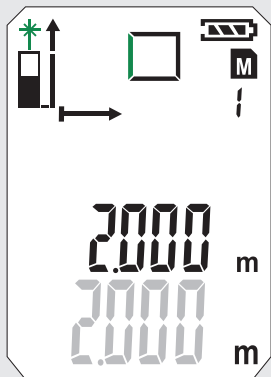
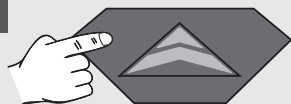

2

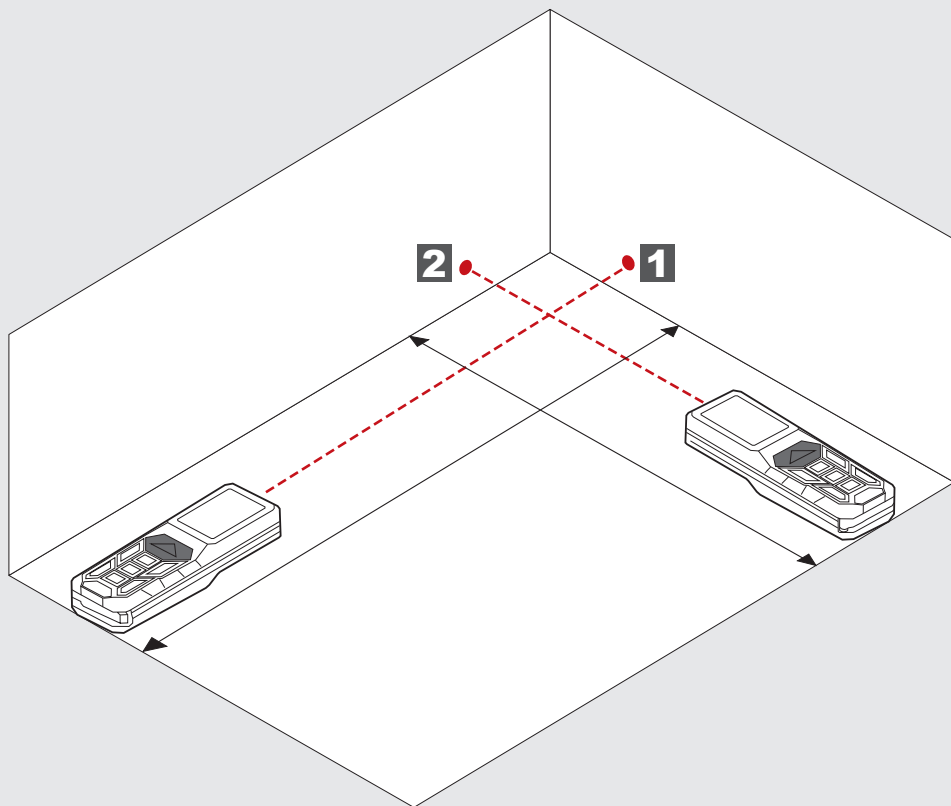
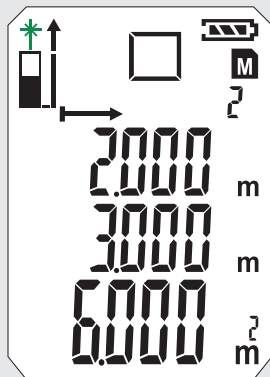
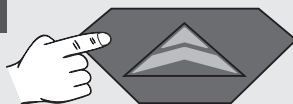

MESURE VOLUME

0

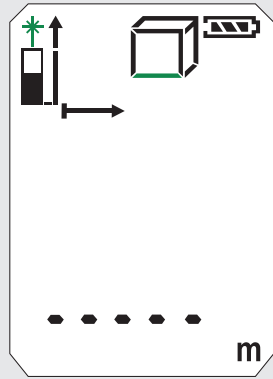

1

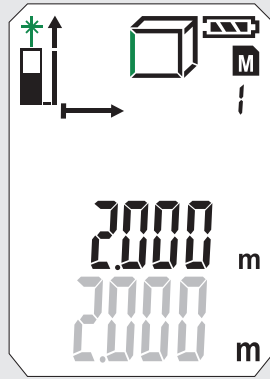
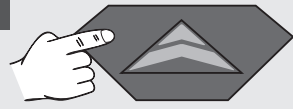

2

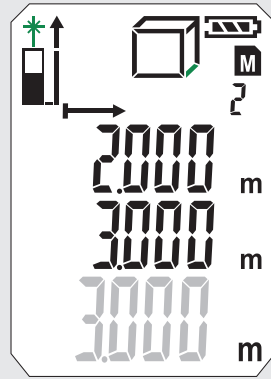
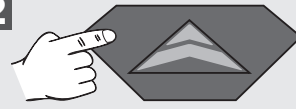

3

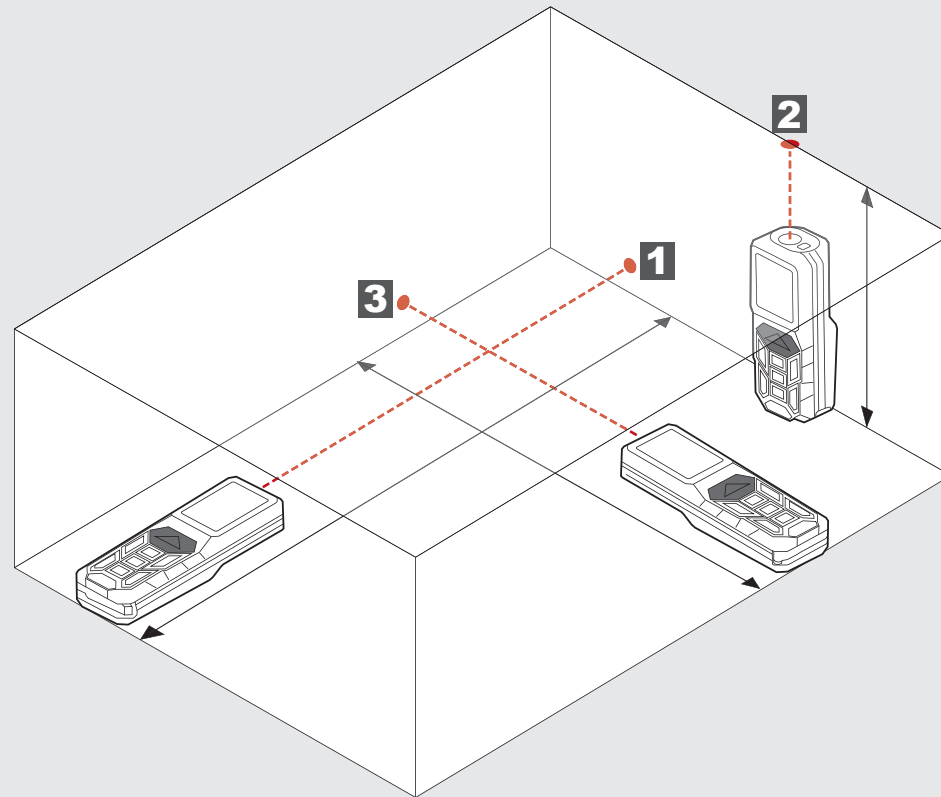
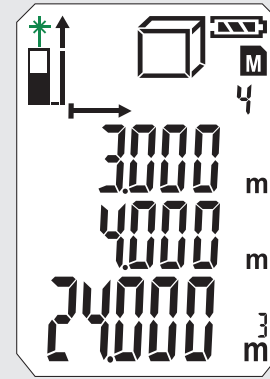
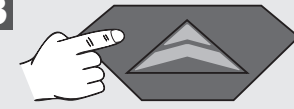

MESURE INDIRECTE (PYTHAGORE 1)

0



1

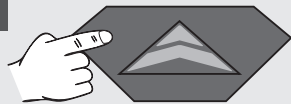

2

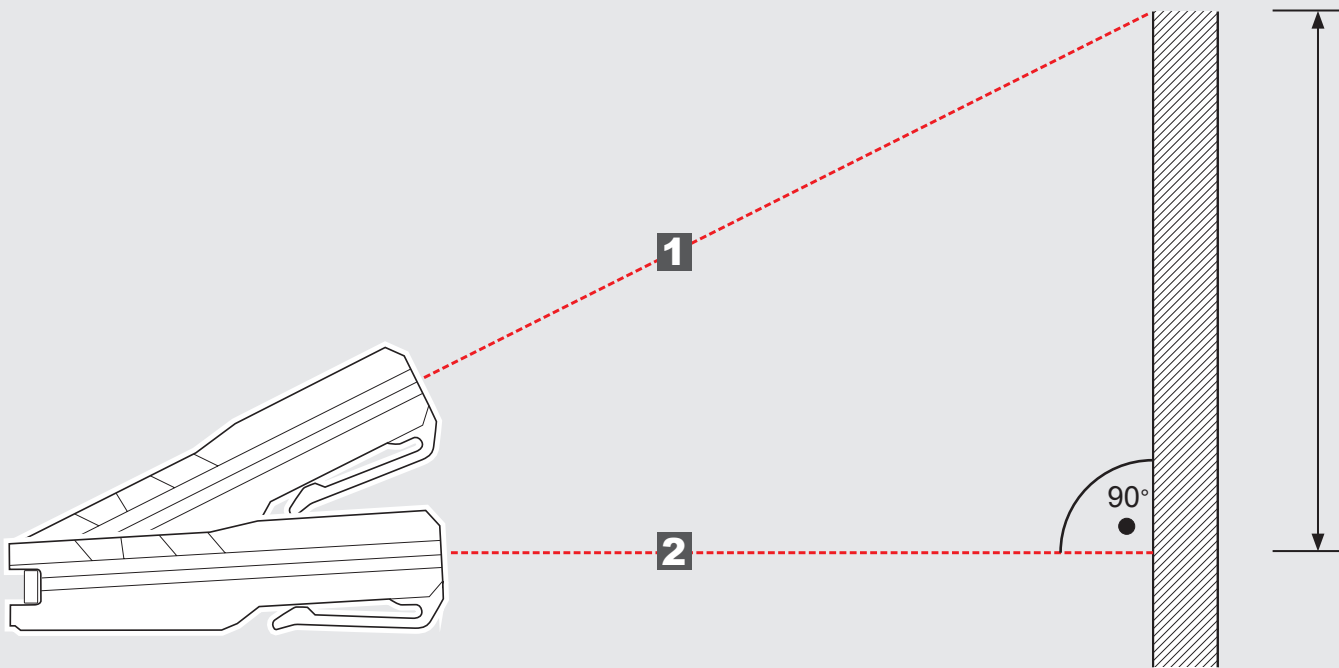
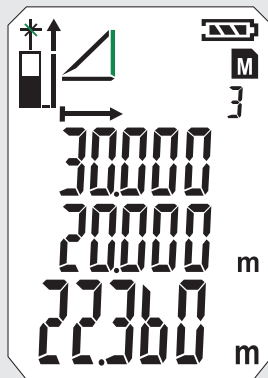
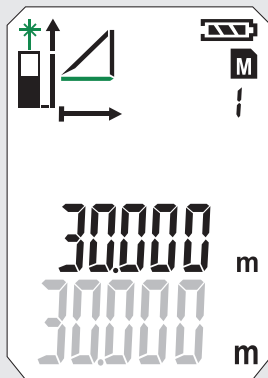
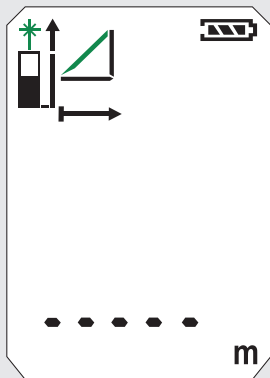
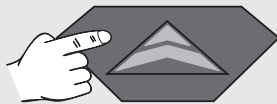

MESURE INDIRECTE (PYTHAGORE 2)

0



1

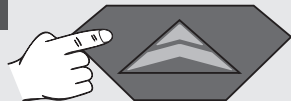

2



3

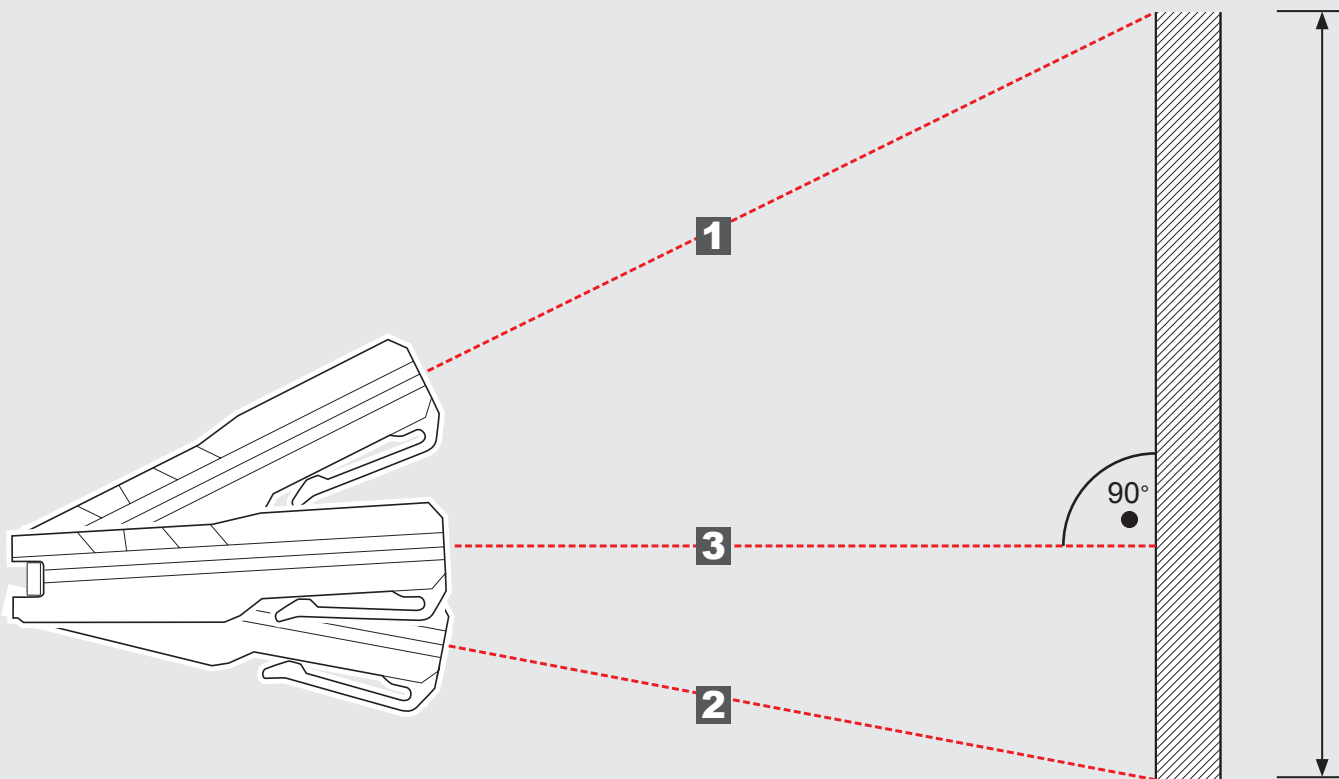
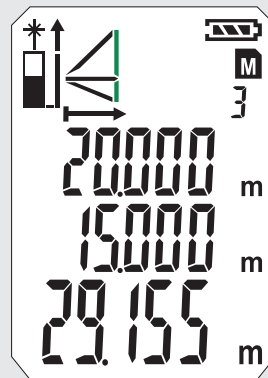
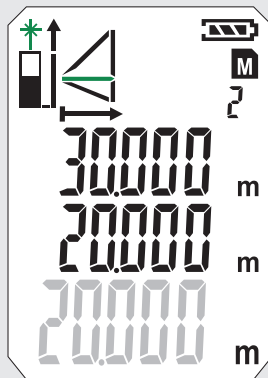
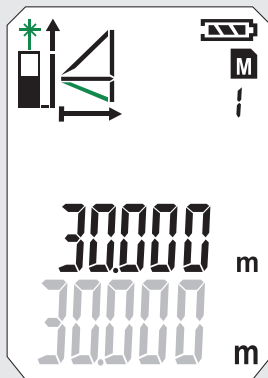
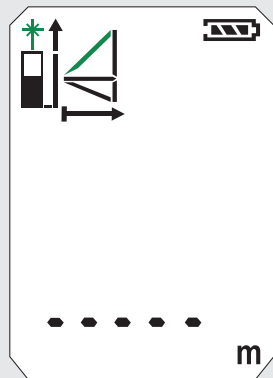

MESURE INDIRECTE (PYTHAGORE 3)

1



2

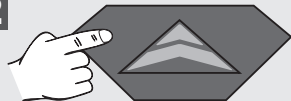







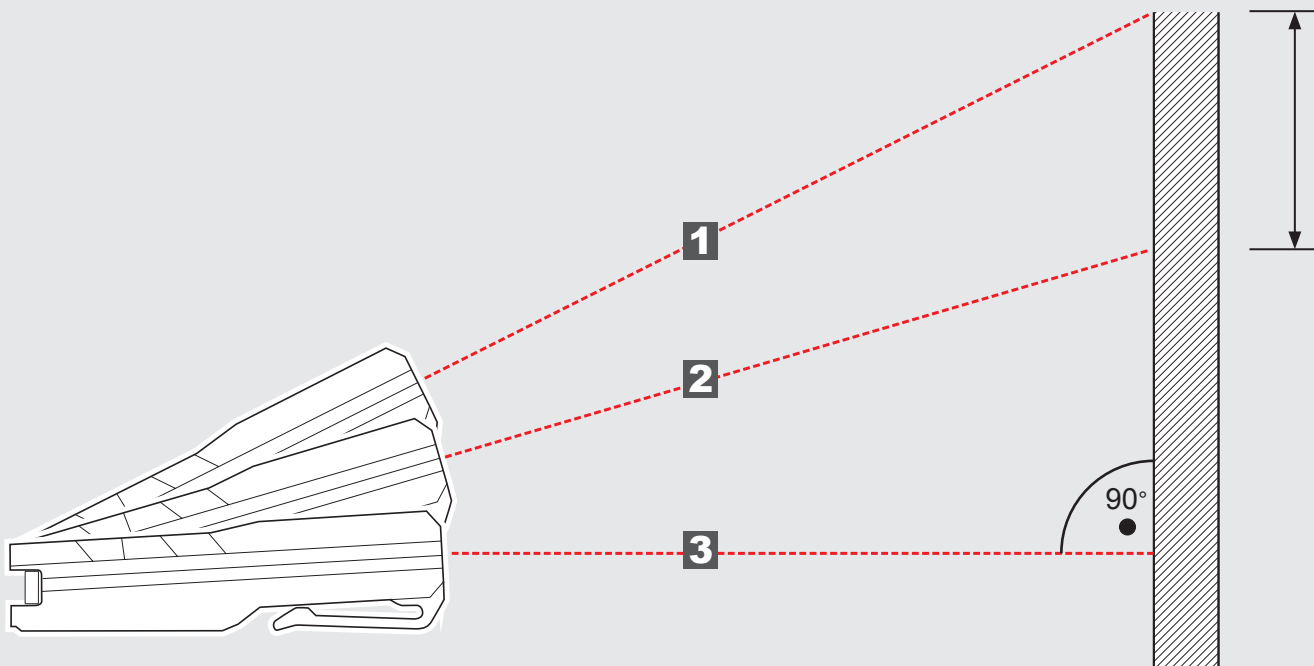
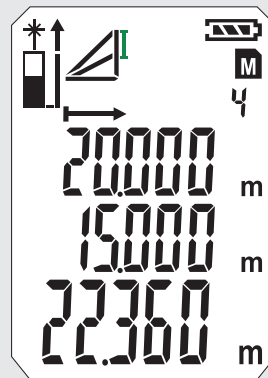
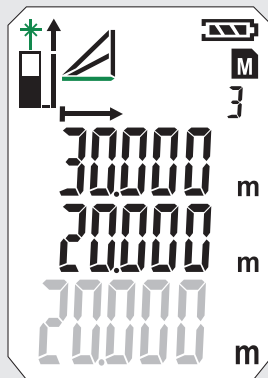
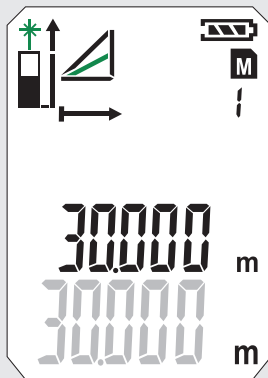
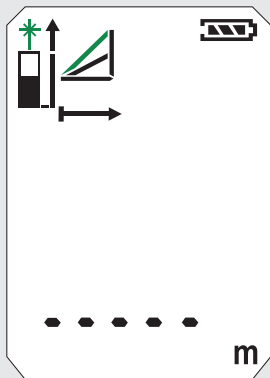





3



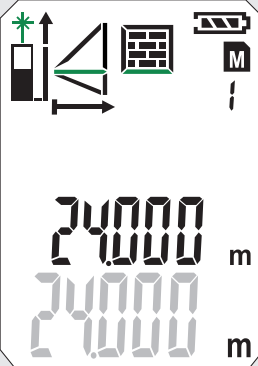

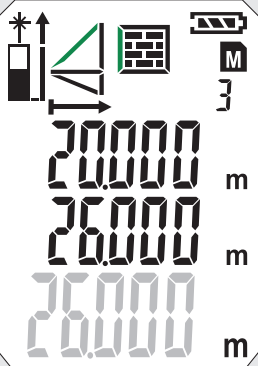
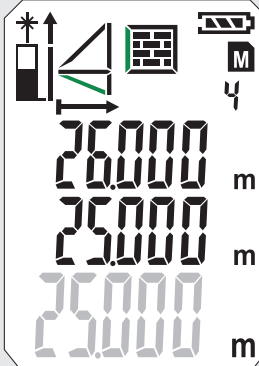
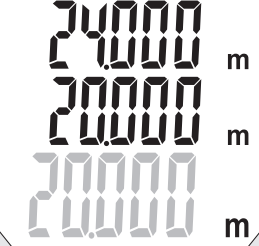
4

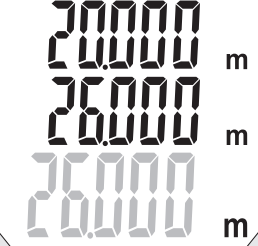

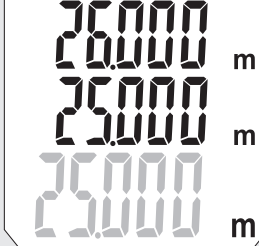

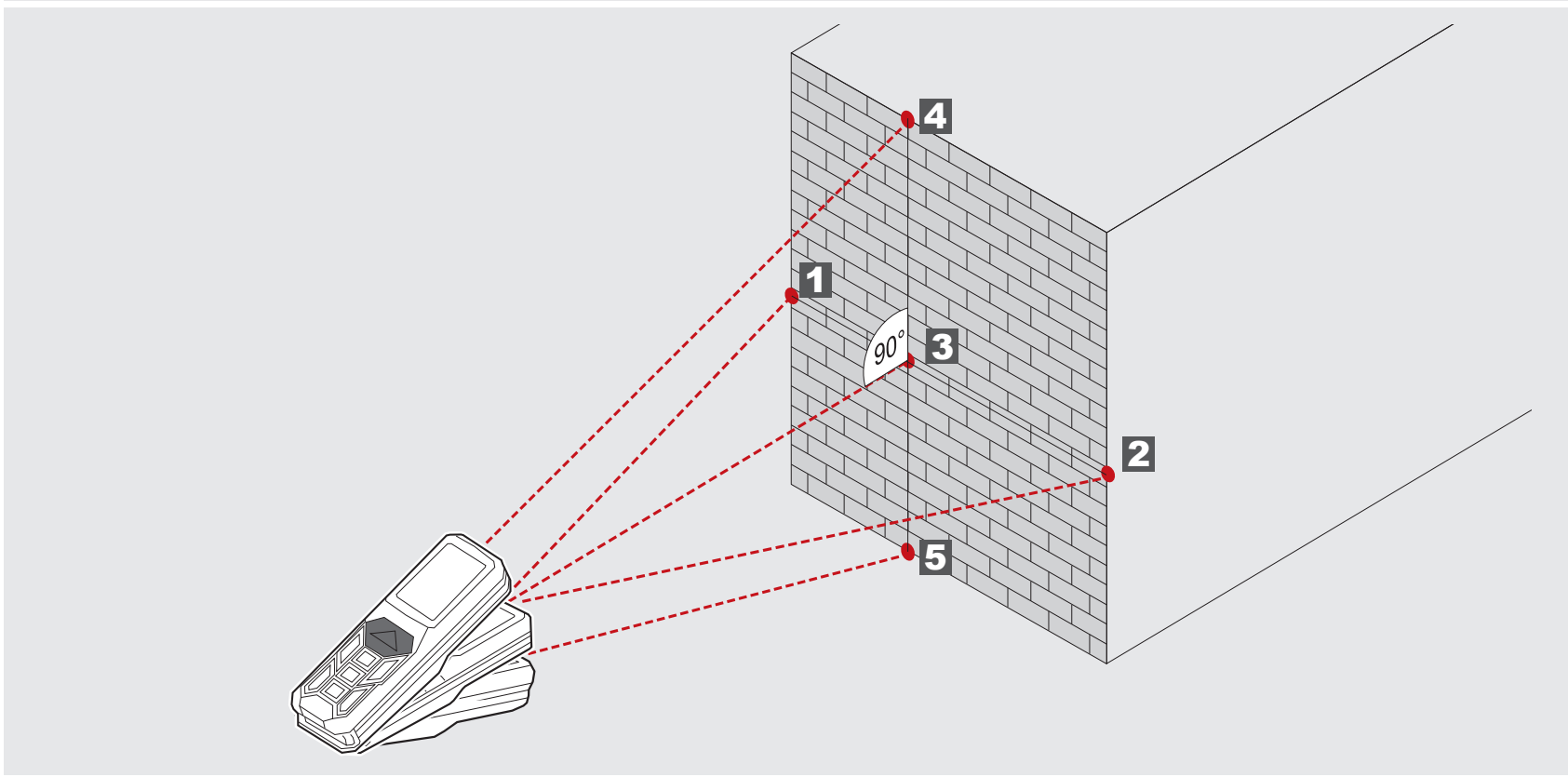
MESURE SURFACE PAROI (SCÈNE 1)

0 	1 	2 	3 	4 
 	 	 	 	 

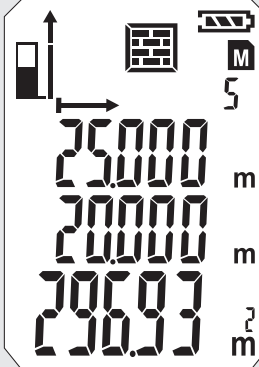

5 

MESURE SURFACE PAROI (SCÈNE 2)

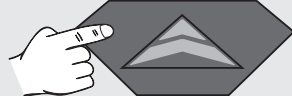
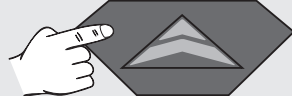
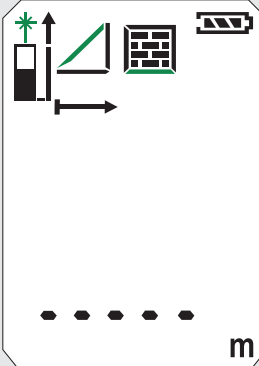
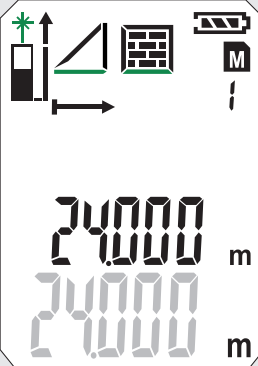
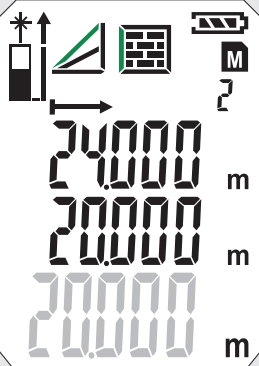
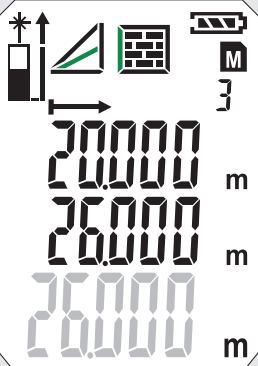
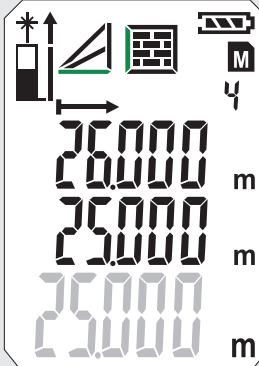
0 	1 	2 	3 	4 
				

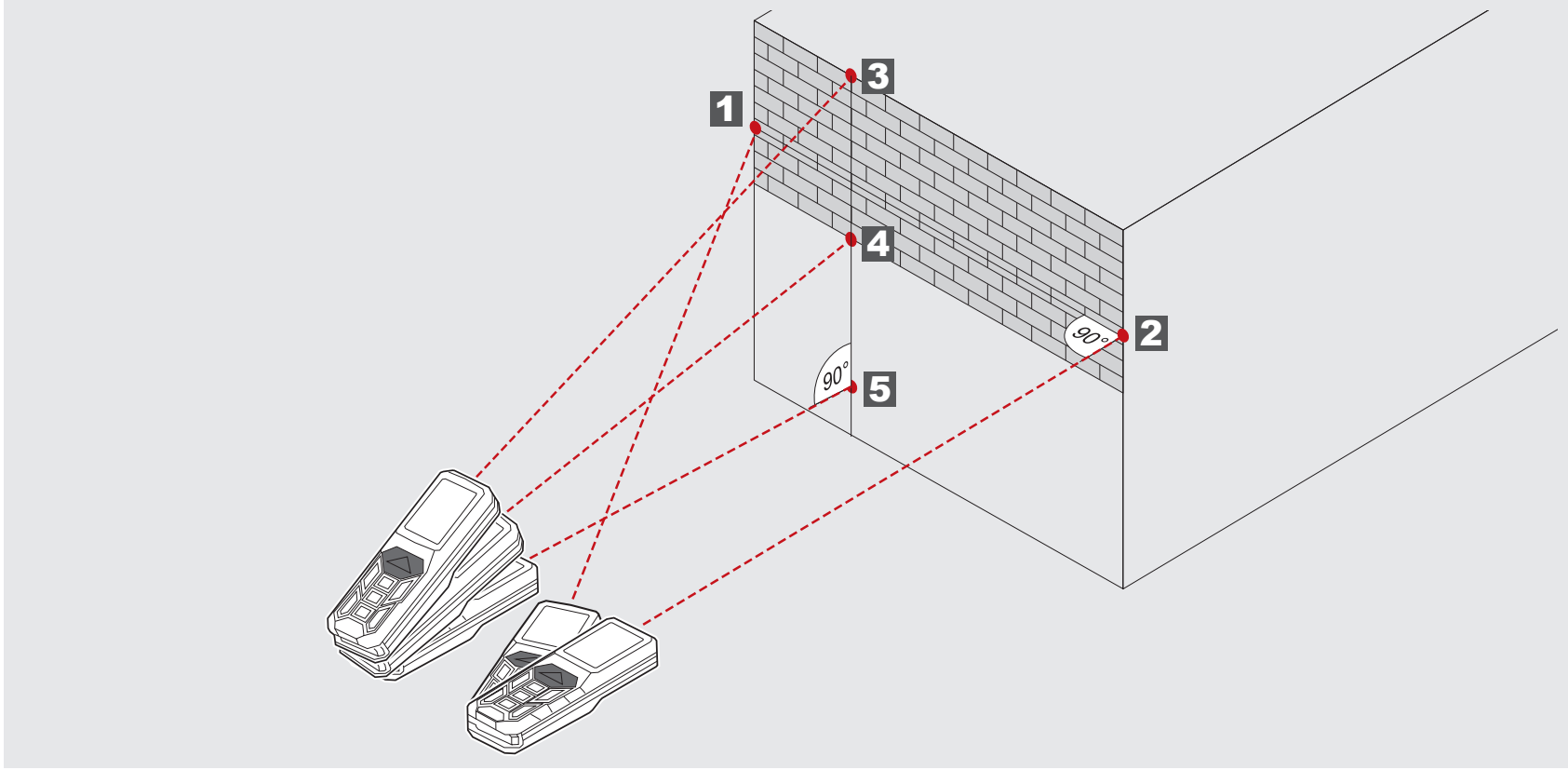

5



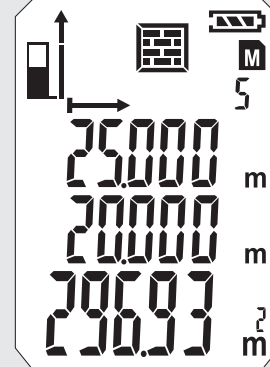



TIMER

Le timer permet de retarder le démarrage de la mesure, par ex. pour placer un composant dans le rayon de mesure.

Actionner la touche 

- Le symbole  sera affiché
Par l'appui sur la touche  il sera possible de sélectionner le timer entre 3 et 15 sec.

Actionner la touche 

- Le compte à rebours jusqu'à la mesure démarre.
- Au 0, la mesure sera activée.

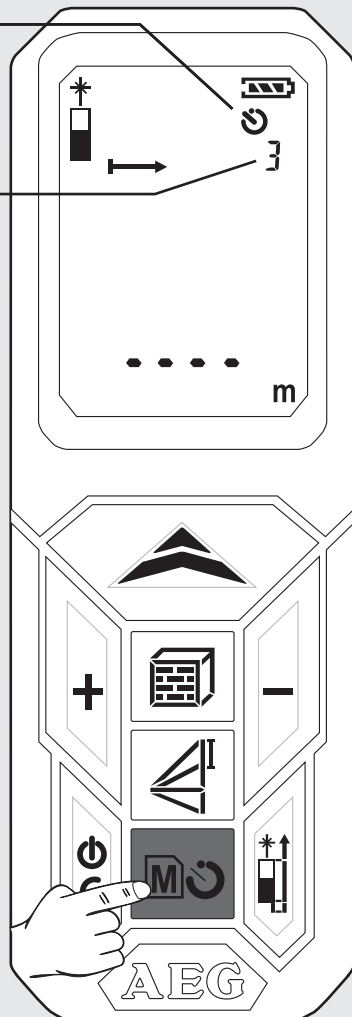

MÉMOIRE

Les valeurs mesurées seront sauvegardées en mémoire automatiquement d'une façon progressive.

Les valeurs mémorisées pourront être sélectionnées par la touche .

Maintenir la touche  enfoncée pendant 2 sec.

- Le symbole et l'espace de mémoire seront affichés.
- Le paramètre de mesure intéressé sera affiché.
- La valeur mémorisée est affichée dans la ligne principale.
- Utiliser les touches +/- pour naviguer

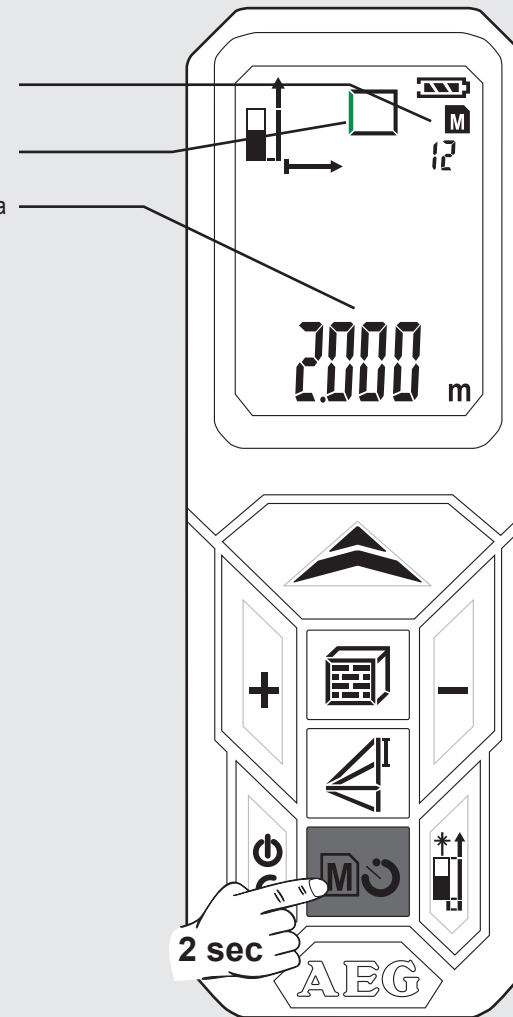



FONCTIONNEMENT DE BASE EXEMPLIFIÉ POUR LA MESURE DE LA SURFACE (1)

1 Activer

Actionner la touche 
⚠ Attention ! Rayon laser on !
 Ne pas diriger sur des personnes !

2 Sélectionner le plan de mesure

Sélection standard à l'activation:
 postérieure
 Enfoncer 1x -> pointe multifonction
 enfoncer 2x -> antérieur
 enfoncer 3x -> postérieur

3 Sélectionner la fonction

A l'activation le dispositif est toujours
 sélectionné sur mesure longueur.
 enfoncer 1x - mesure surface
 - Le symbole est affiché

4 Mesurer la longueur

Orienter le dispositif
 et enfoncer la
 touche 

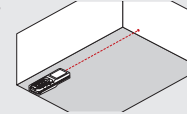

5 Mesure largeur

Orienter le dispositif
 et enfoncer la
 touche 

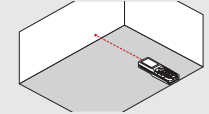

Le symbole laser clignote
 (clignotement indiqué vert).

Le symbole est affiché

- Le paramètre mesuré clignote
 (clignotement indiqué vert)

- La valeur mémorisée est affichée
 brièvement dans la ligne principale.
 - Après 1 sec. la valeur mesurée se
 déplace sur la ligne supérieure.
 - La valeur mesurée sera mémorisée
 avec un nombre progressif.
 - Le second paramètre mesuré
 clignote.
 Le dispositif est prêt à la mesure de
 la seconde valeur.

- La valeur mémorisée est affichée
 brièvement dans la ligne principale.
 - Après 1 sec. la valeur mesurée se
 déplace sur la ligne supérieure.
 - La valeur mesurée sera mémorisée
 avec un nombre progressif.
 - Le résultat est affiché dans la ligne
 principale et sera sauvegardé en
 mémoire avec un nombre progressif.

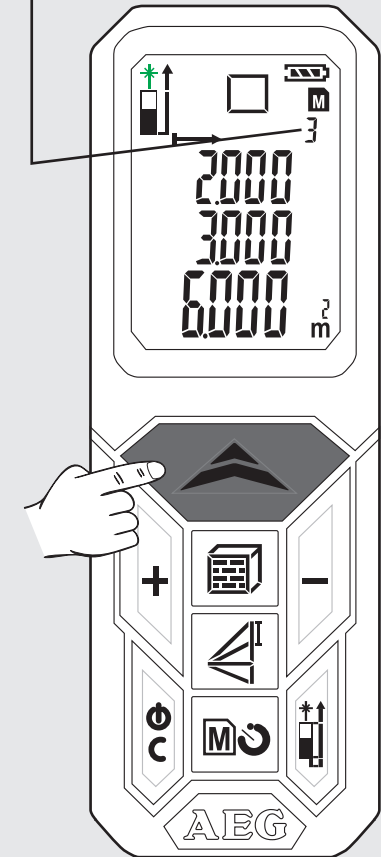
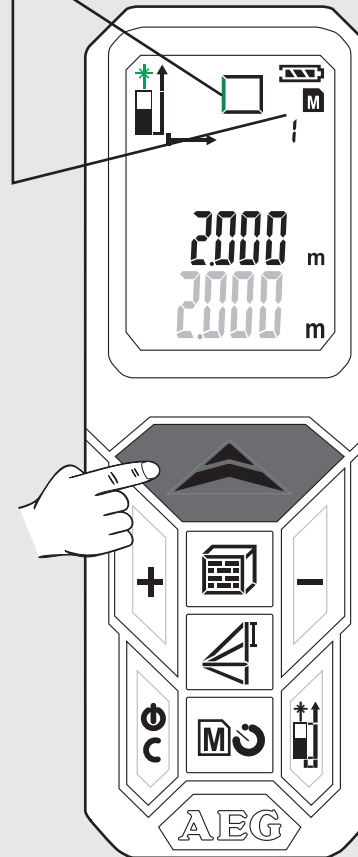
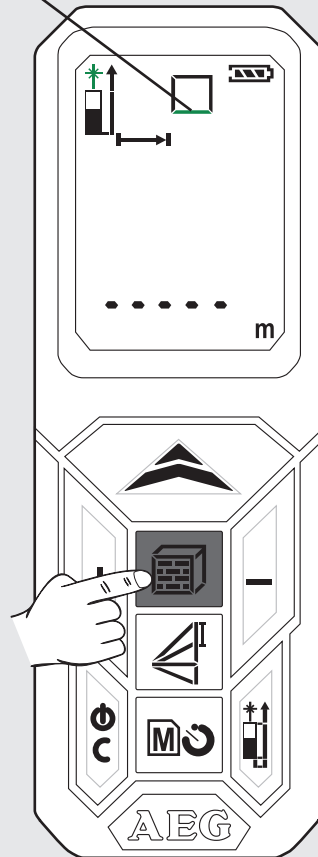
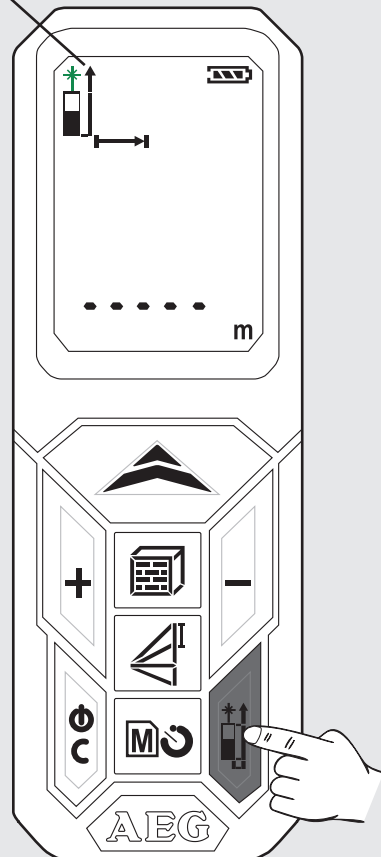
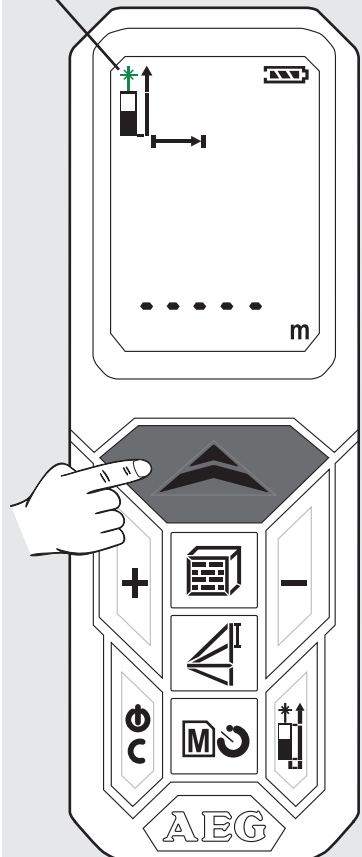

FONCTIONNEMENT DE BASE EXEMPLIFIÉ POUR LA MESURE DE LA SURFACE (2)

6 Sélectionner les valeurs sauvegardées

Maintenir la touche  enfoncée pendant 2 sec.

Enfoncer la touche + ou -.

- Les valeurs mémorisées seront affichées dans la ligne principale.

- Le symbole intéressé sera affiché et le paramètre mesuré clignotera (clignotement indiqué vert).

7 Sortir de la mémoire

Actionner la touche .

8 Désactiver

Maintenir la touche  enfoncée pendant 2 sec
(Avant la désactivation, il est nécessaire de sortir de la mémoire).

- Le dispositif se désactive.

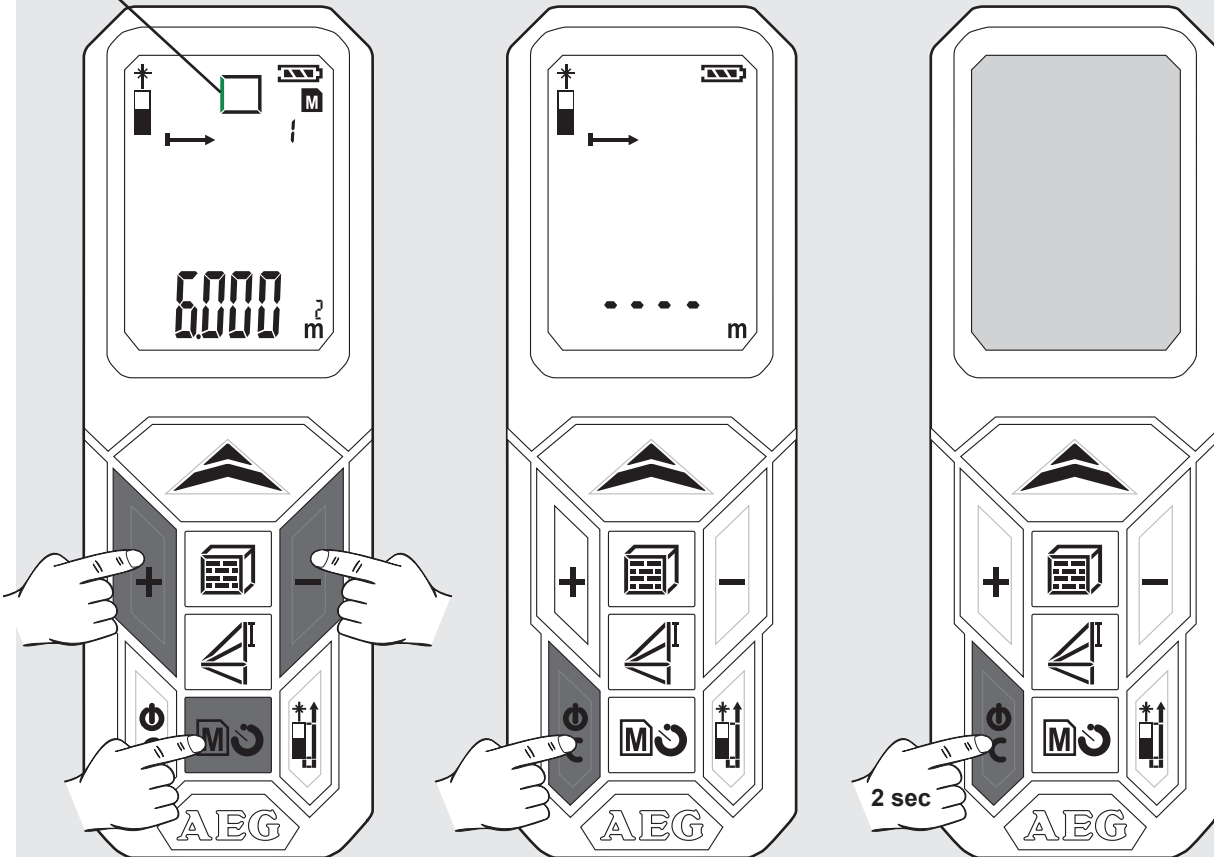

- Si dans les 3 minutes suivantes aucune touche ne sera actionnée, le dispositif se désactivera automatiquement.



INDICE

- Importanti istruzioni di sicurezza1
- Dati tecnici2
- Utilizzo conforme2
- Tabella codici errori.....2
- Panoramica3
- Sostituire la batteria.....4
- Perno d'angolo4
- Clip per cinta.....4
- Tasto funzione, Pitagora, piano di misurazione5
- Misurazione lunghezza semplice.....6
- Misurazione continua / misurazione minimo/massimo7
- Misurazione per addizione / sottrazione8
- Misurazione superficie.....9
- Misurazione volume.....10
- Misurazione indiretta (Pitagora 1).....11
- Misurazione indiretta (Pitagora 2).....12
- Misurazione indiretta (Pitagora 3).....13
- Misurazione superficie parete (scenario 1).....14
- Misurazione superficie parete (scenario 2).....15
- Timer16
- Memoria.....16
- Funzionamento di base esemplificato per la misurazione della superficie (1).....17
- Funzionamento di base esemplificato per la misurazione della superficie (2).....18

IMPORTANTI ISTRUZIONI DI SICUREZZA

  Non usare il prodotto prima di avere studiato le Istruzioni di sicurezza e il Manuale d'uso sul CD in allegato.

Classifica laser

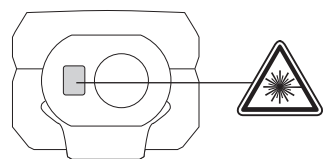

AVVERTENZA:
Si tratta di un prodotto laser di classe 2 conforme a IEC 60825-1:2007.



Targhetta

Prima della prima messa in esercizio, coprire il testo inglese della targhetta di fabbrica con l'etichetta fornita a corredo nella Sua lingua nazionale.

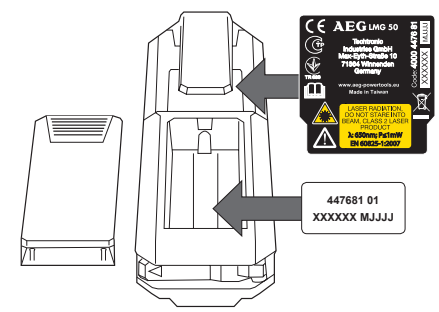

Avvertenza:
Evitare qualsiasi contatto visivo diretto. Il raggio laser può causare un accecamento temporaneo da flash agli occhi.
Non fissare il raggio laser né puntarlo verso altri senza motivo.
Non abbagliare altre persone.

Avvertenza:
Non usare il dispositivo a laser nelle vicinanze di bambini e non permettere ai bambini di usare il dispositivo a laser.
Attenzione! Superfici riflettenti potrebbero fare riflettere il raggio laser sull'operatore o su altre persone.

Tenere le estremità a una distanza di sicurezza.
Effettuare periodicamente delle misure di controllo, soprattutto prima, durante e dopo misurazioni di particolare importanza.
Se il prodotto è difettoso, è caduto, è stato usato in modo improprio o modificato potrebbe fornire misurazioni errate.
Attenzione! Acquisire destrezza con gli elementi di comando ed il corretto utilizzo dell'apparecchio per il giardinaggio.

Il dispositivo di misura a laser ha un range di applicazione limitato. (Vedi il capitolo "Dati tecnici"). Tentativi di misurare al di fuori del range massimo e minimo causano imprecisioni. L'uso in presenza di condizioni atmosferiche avverse, come temperature eccessivamente alte o basse, luce solare molto intensa, pioggia, neve, nebbia o altre condizioni che limitano la visibilità, può comportare misurazioni imprecise.

Se il dispositivo di misura a laser viene portato da un ambiente caldo in un ambiente freddo (o vice-versa), attendere che il dispositivo si adatti alla nuova temperatura ambiente.

Conservare il dispositivo di misura a laser sempre in ambienti chiusi, proteggerlo da urti, vibrazioni e temperature estreme. Proteggere il dispositivo di misura a laser da polveri, liquidi ed elevata umidità dell'aria. I suddetti fattori potrebbero danneggiare gravemente i componenti interni o influenzare negativamente la precisione.

Non usare detergenti aggressivi o solventi. Pulire soltanto con un panno pulito, morbido.

Evitare forti urti sul dispositivo di misura a laser o la sua caduta. Dopo una caduta del dispositivo di misura a laser o dopo una sua esposizione ad altre sollecitazioni meccaniche è necessario verificare la precisione del dispositivo.

Le riparazioni eventualmente necessarie sul dispositivo a laser devono essere eseguite esclusivamente da personale specializzato autorizzato!

Non azionare il prodotto in aree a rischio di esplosione o in ambienti aggressivi.

Utilizzare solo cariche batterie raccomandati dal produttore.

 Non smaltire le batterie scariche assieme ai rifiuti domestici. Al fine di garantire il rispetto dell'ambiente smaltirle presso i punti di raccolta esistenti secondo quanto previsto dalle disposizioni nazionali o locali. Non smaltire il prodotto assieme ai rifiuti domestici. Altire il prodotto correttamente, nel rispetto delle normative vigenti nel paese d'uso. Attenersi alle norme nazionali e locali vigenti in materia. Contattare le autorità locali o il rivenditore per ottenere informazioni sullo smaltimento.



DATI TECNICI

Classe di protezione	IP54 (protezione da polveri e spruzzi d'acqua)
Ottica	14 mm
Punto focale	35 mm
Range di misurazione max.	50 metri (tolleranza: 55m)
Range di misurazione min.	0,05 metri
Precisione assoluta @ < 10m	± 1,5 mm (max)
Precisione di ripetibilità @ < 10m	± 1,5 mm (tipicamente max. 2σ)
Precisione di ripetibilità @ > 10m	salita ± 0,25 mm / metro (tipicamente max. 2σ)
Tempo di misurazione	0,5 s
Display tipo	LCD (22,7 mm x 31 mm)
Alimentazione	AAA 2x (batteria alcalina)
Durata batteria	10000 (misurazione singola)
Potenza di uscita laser	0,6 mW ~ 0,95 mW (Class 2, 650nm)
Dimensione punto laser	25 x 30 mm @ 16 m (max)
Raggio laser angolo verticale	+1 grado
Raggio laser angolo orizzontale	±1 grado
Disattivazione automatica dispositivo	180 secondi
Disattivazione automatica laser	30 secondi
Range temperatura di lavoro	da -10°C a +50°C
Range temperatura di immagazzinaggio	da -25°C a +70°C
Peso senza batteria	80 g

UTILIZZO CONFORME

Il dispositivo di misura a laser è atto a misurare distanze ed inclinazioni.

Utilizzare il prodotto solo per l'uso per cui è previsto.

TABELLA CODICI ERRORI

Codice	Descrizione	Soluzione
Err01	Fuori range di misurazione	Misurare nel range previsto.
Err02	Segnale riflesso troppo debole	Scegliere una superficie più idonea.
Err03	Fuori range di visualizzazione (valore max: 99.999) è ad esempio il risultato di una superficie o volume al di fuori del range di visualizzazione	Verificare se i valori ed i passi sono corretti.
Err04	Errore nel calcolo di Pitagora	Verificare se i valori ed i passi sono corretti.
Err05	Batteria scarica	Sostituire le batterie.
Err06	Fuori range della temperatura di lavoro	Eseguire la misurazione nel range previsto per la temperatura di lavoro.
Err07	Eccessiva luce ambiente	Oscurare l'area target.

Pitagora
Differenza altezza

Piano di misurazione

Misurazione lunghezza

Minimo / massimo per misurazione continua

Addizione / sottrazione

Superficie / volume
Misurazione indiretta della superficie

Livello batteria

Memoria

Timer

Misurazione continua

Valori intermedi

Valore complessivo

ON / MISURARE

- ▶ ON
- ▶ Misurare
- ▶ Misurazione continua (premere per 2 sec)
Funzione min. / max.

ADDIZIONE

- ▶ Addizione valore
- ▶ Navigazione memoria

SUPERFICIE / VOLUME

- ▶ Superficie (premere 1x)
- ▶ Volume (premere 2x)
- ▶ Misurazione indiretta della superficie (premere 3x / 4x)

ATTIVARE

- ▶ ON
- ▶ Off (premere per 2 sec)
- ▶ Reset

SOTTRAZIONE

- ▶ Sottrazione valore
- ▶ Navigazione memoria

PITAGORA

- ▶ Pitagora 1 (premere 1x)
- ▶ Pitagora 2 (premere 2x)
- ▶ Pitagora 3 (premere 3x)

CAMBIA PIANO DI MISURAZIONE

- ▶ Anteriore
- ▶ Posteriore
- ▶ Perno d'angolo

MEMORIA

- ▶ Timer 3-15 sec. (premere 1x)
- ▶ Memoria 1-20 (premere 1x 2 sec.)
- ▶ Usare i tasti +/- per navigare in memoria

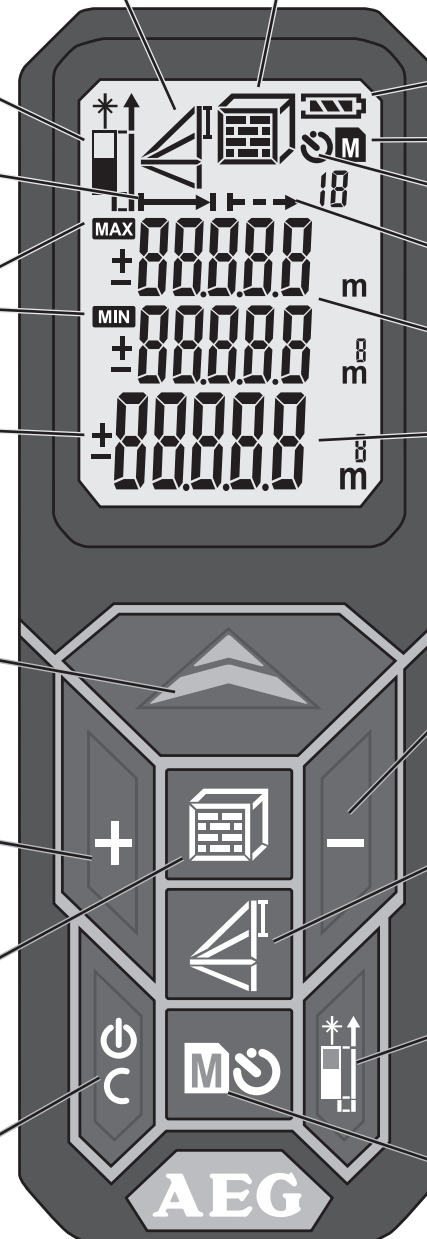

SOSTITUIRE LA BATTERIA

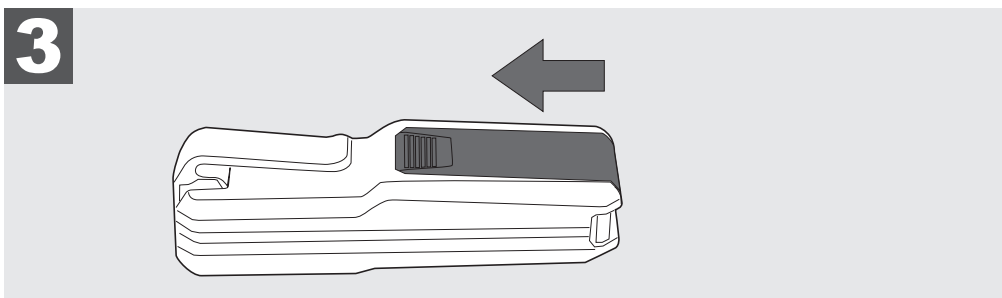
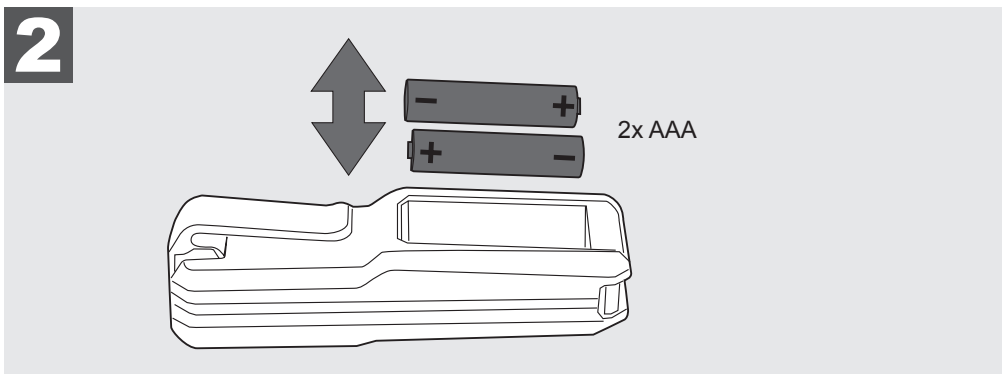
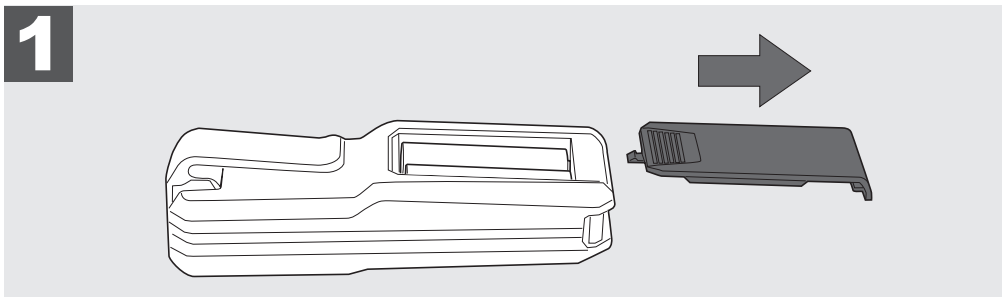
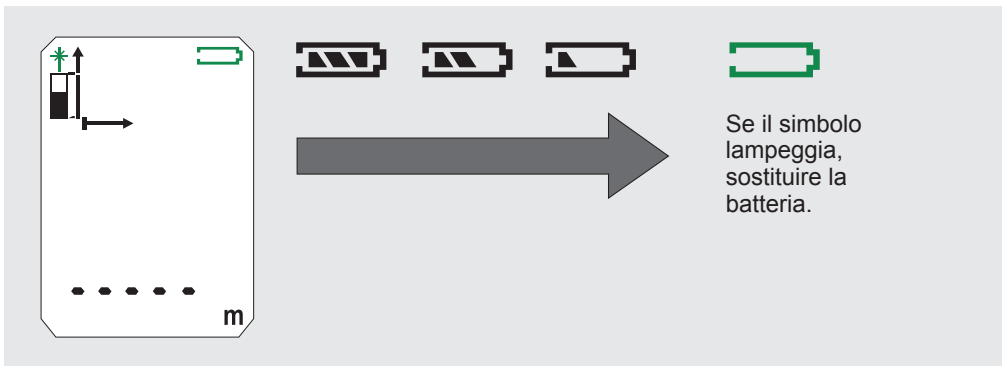

PERNO D'ANGOLO

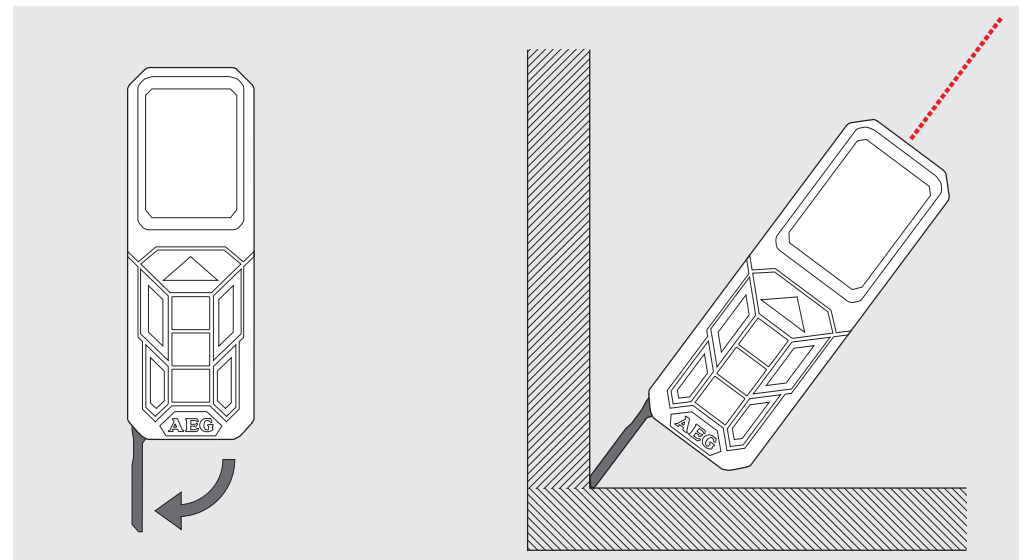

CLIP PER CINTA

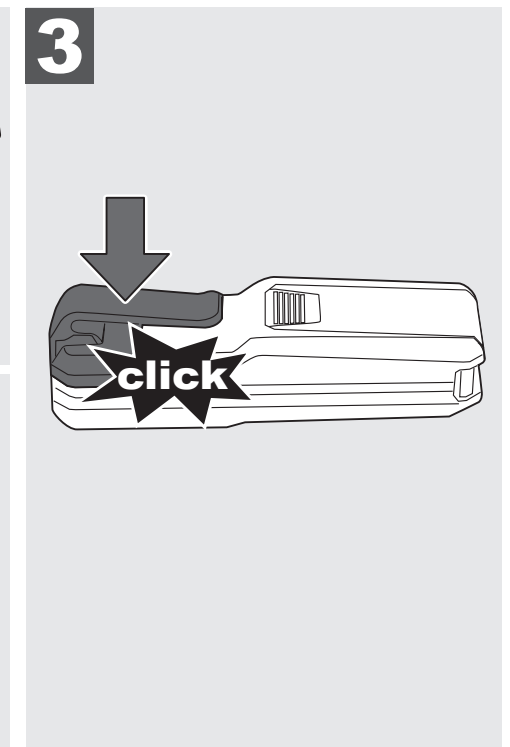
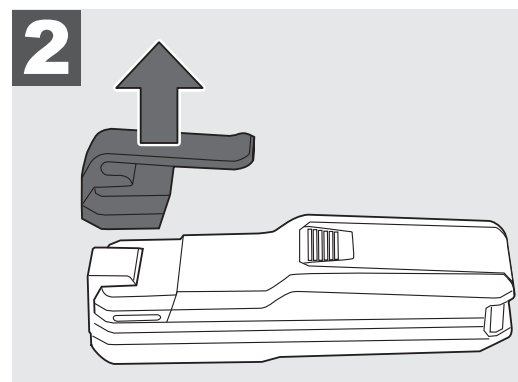
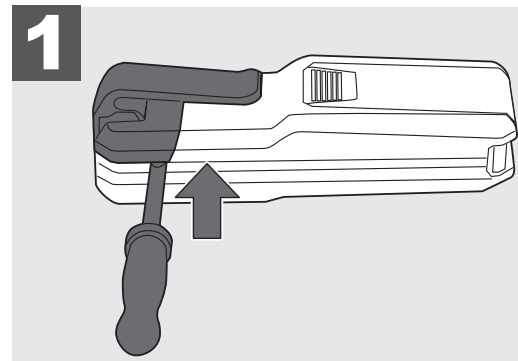

TASTO FUNZIONE, PITAGORA, PIANO DI MISURAZIONE

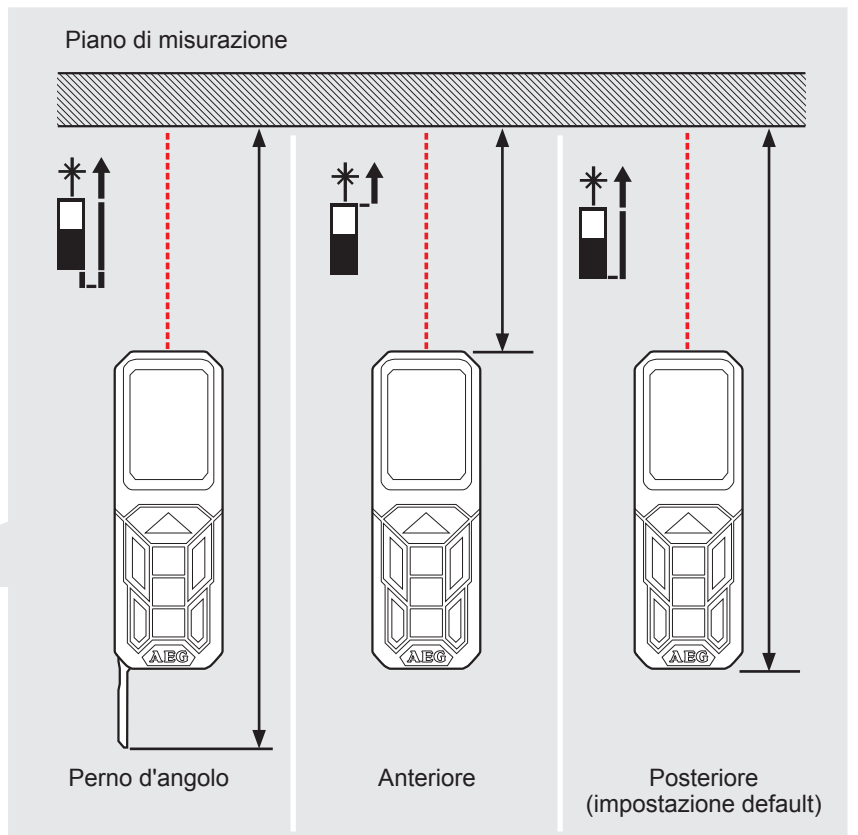
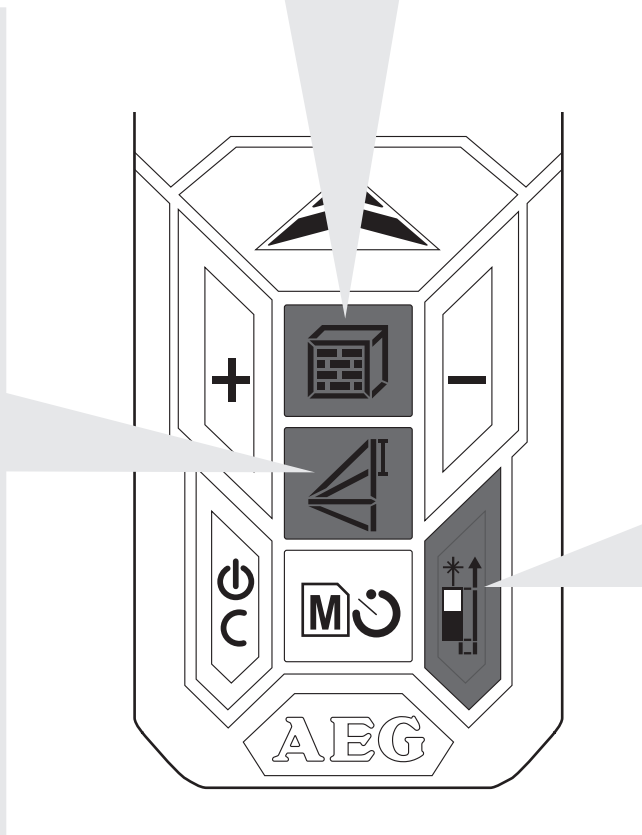
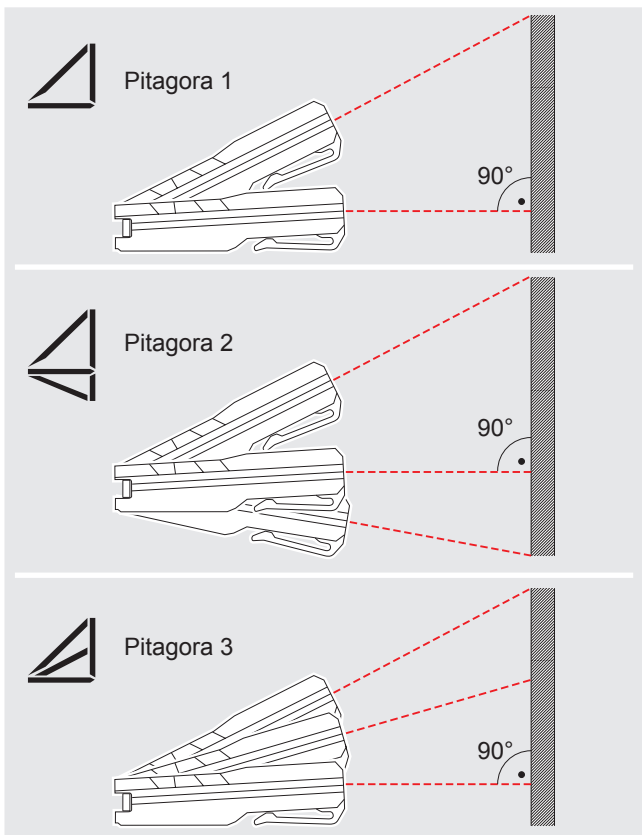
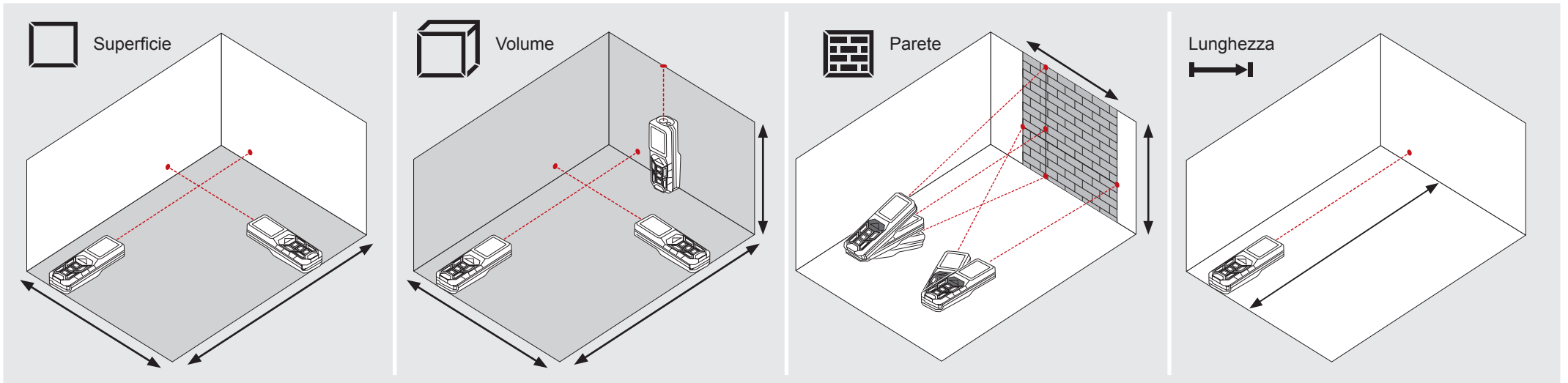

MISURAZIONE LUNGHEZZA SEMPLICE

0

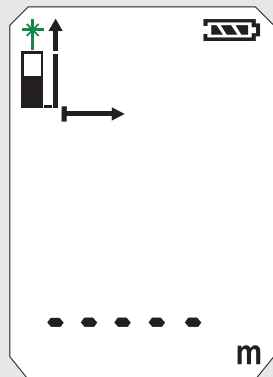

1

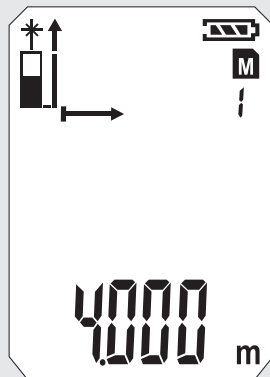
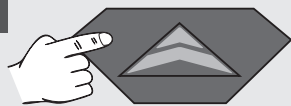

2

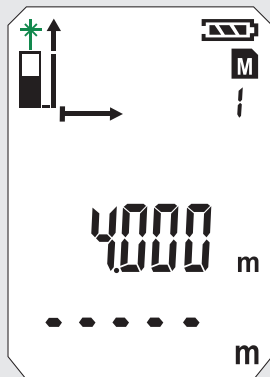
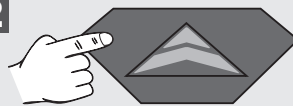

3

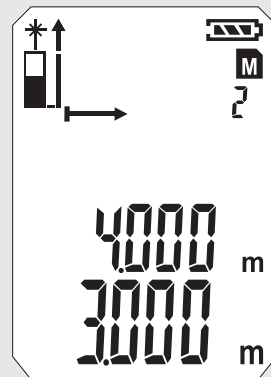
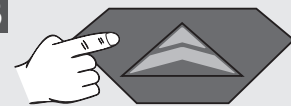

4

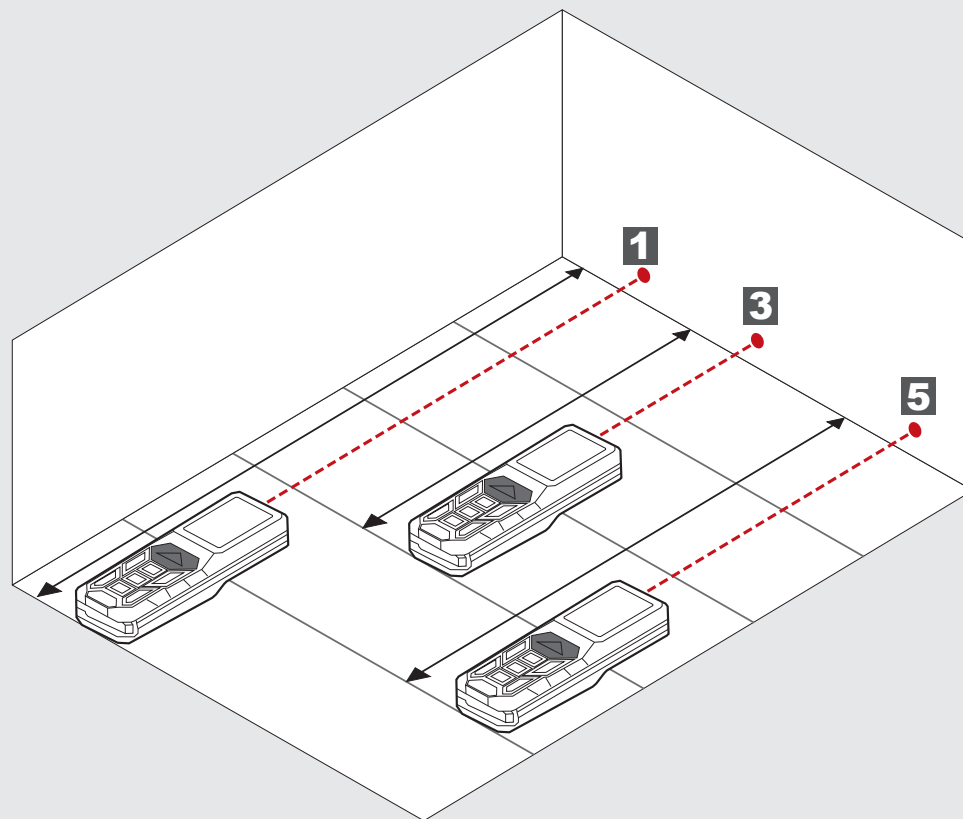
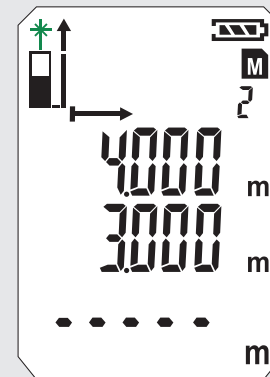
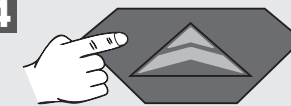

5

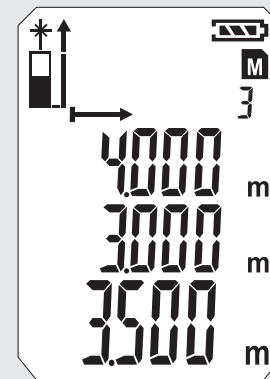
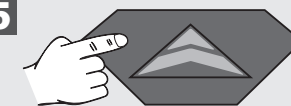

MISURAZIONE CONTINUA / MISURAZIONE MINIMO/MASSIMO

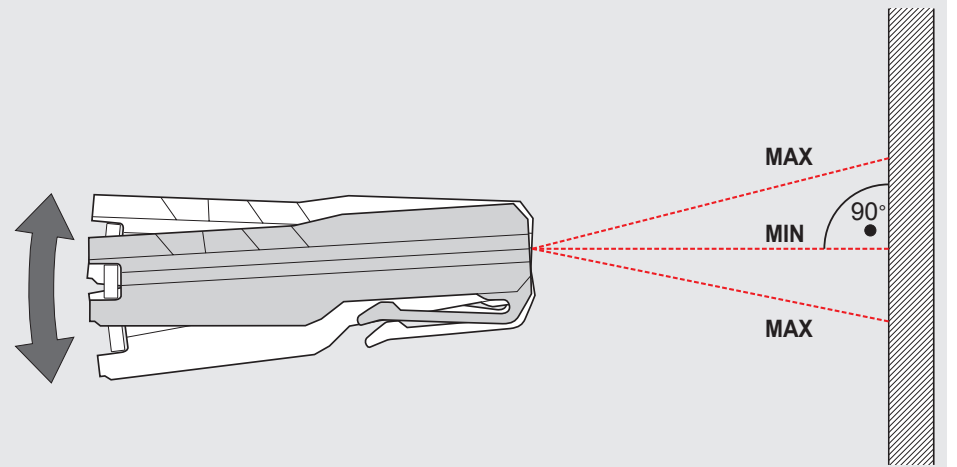
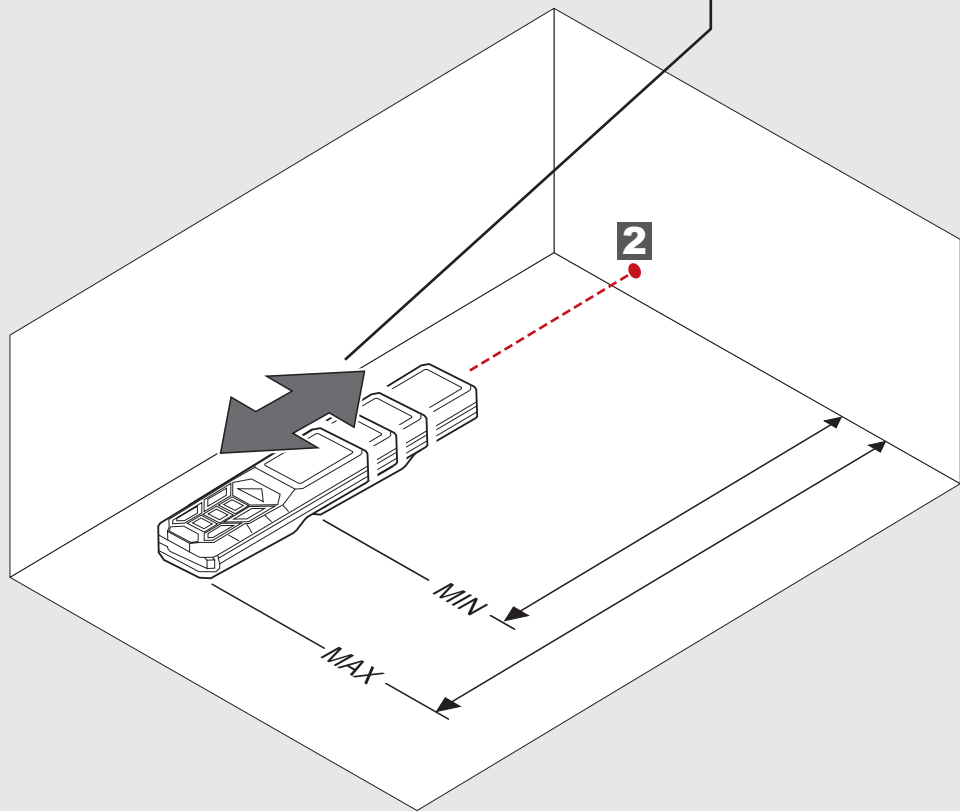
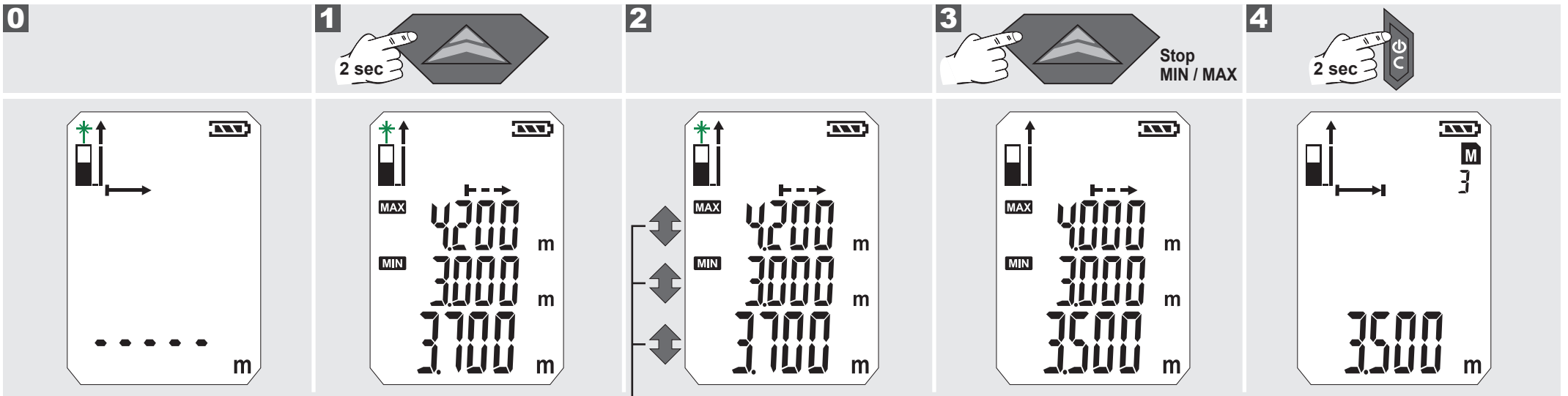

0

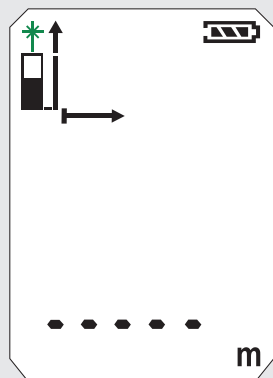

1

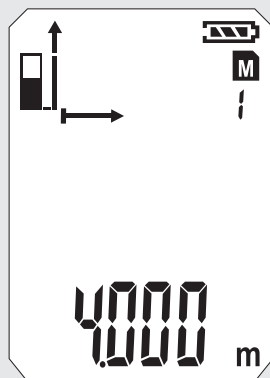
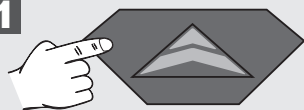

2

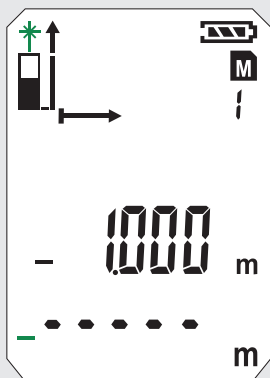
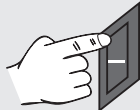

3

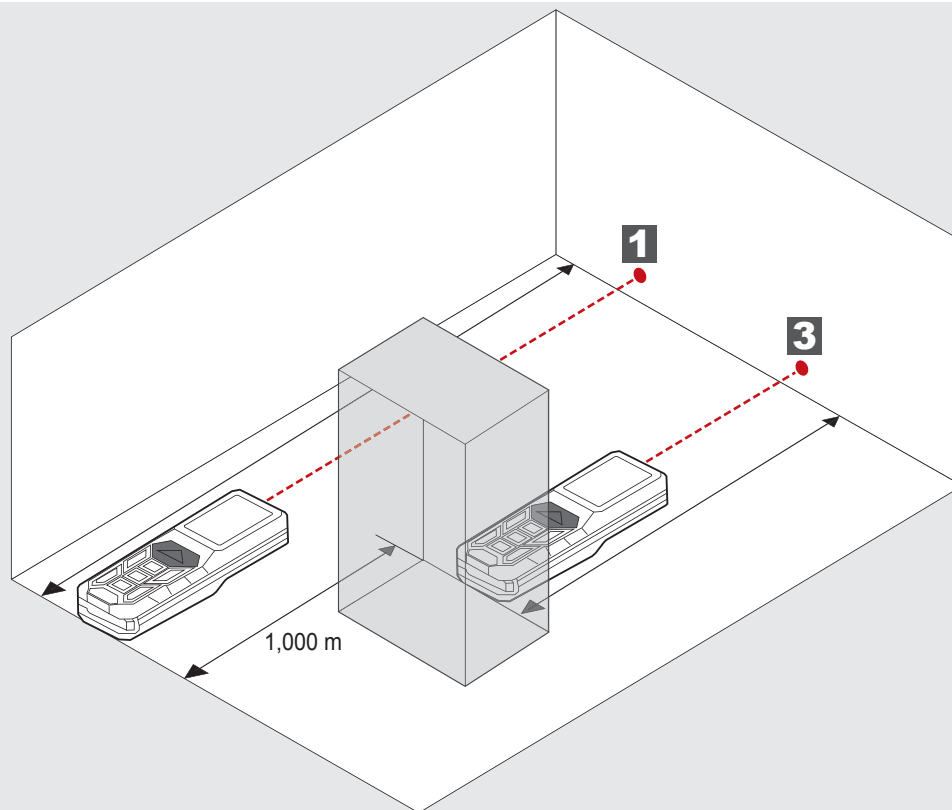
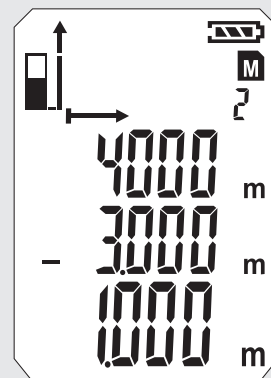
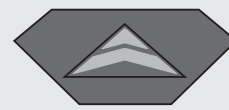

MISURAZIONE SUPERFICIE

0



1

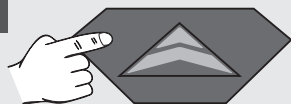

2

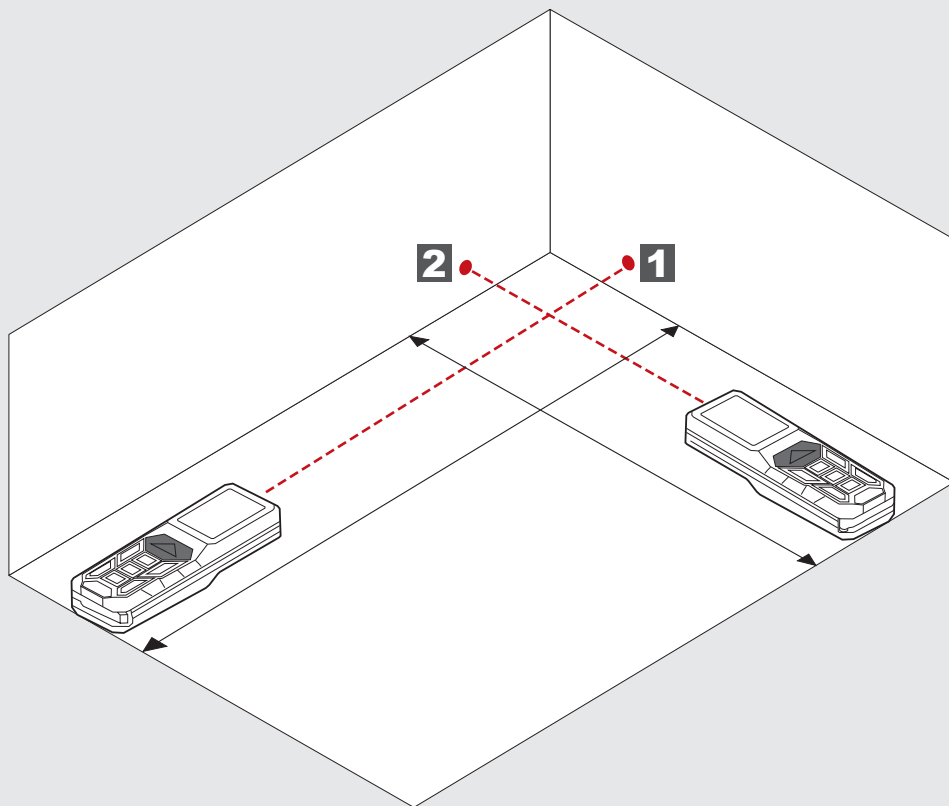
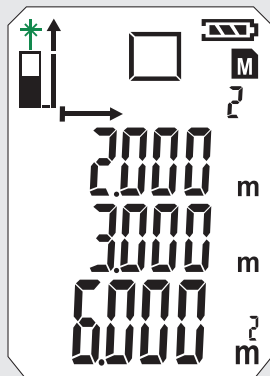
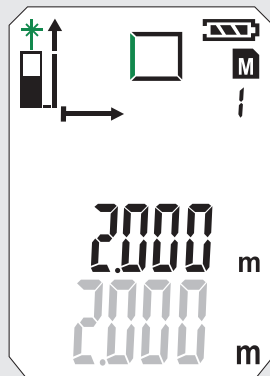
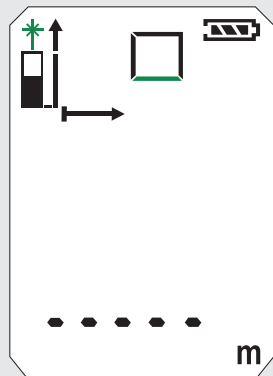
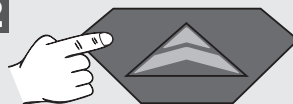

MISURAZIONE VOLUME

0

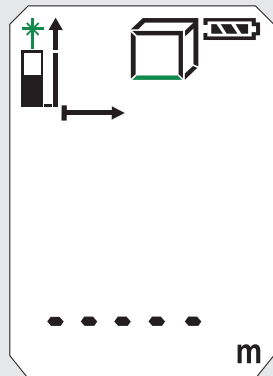

1

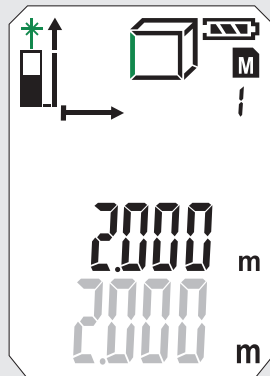
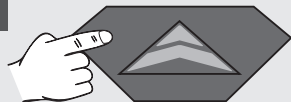

2

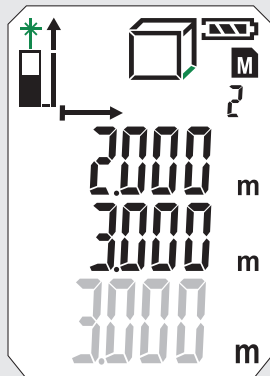
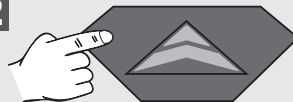

3

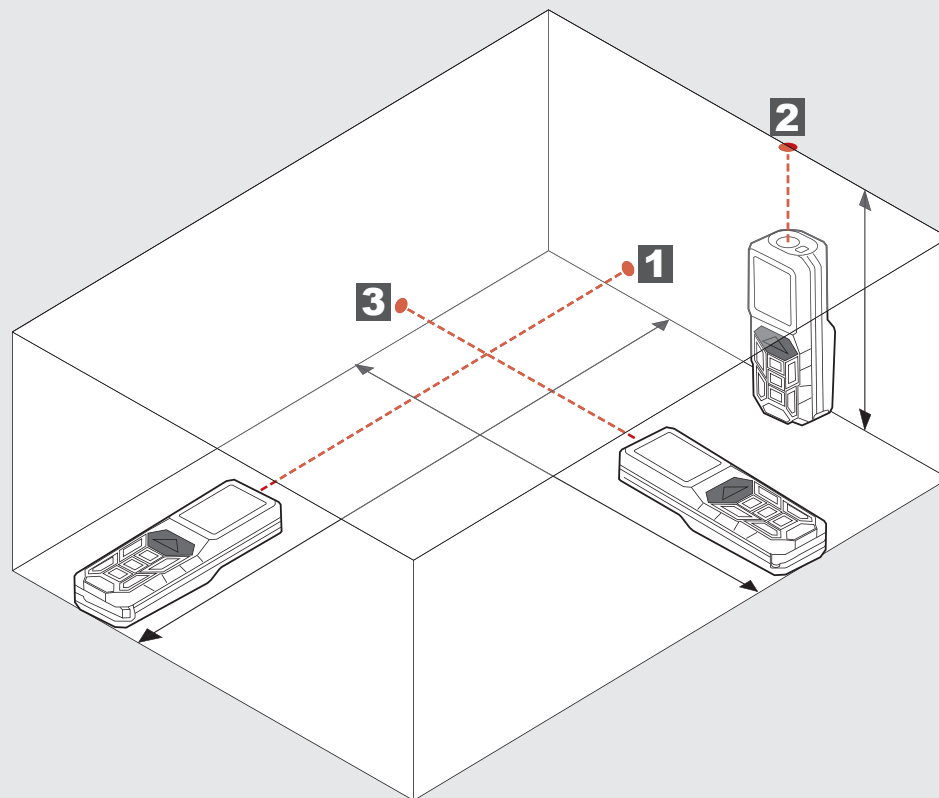
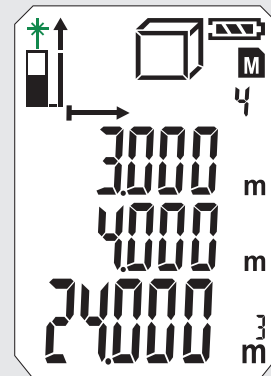
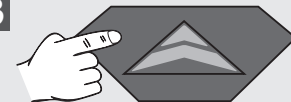

MISURAZIONE INDIRETTA (PITAGORA 1)

0



1

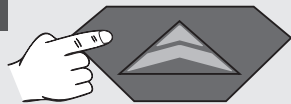

2

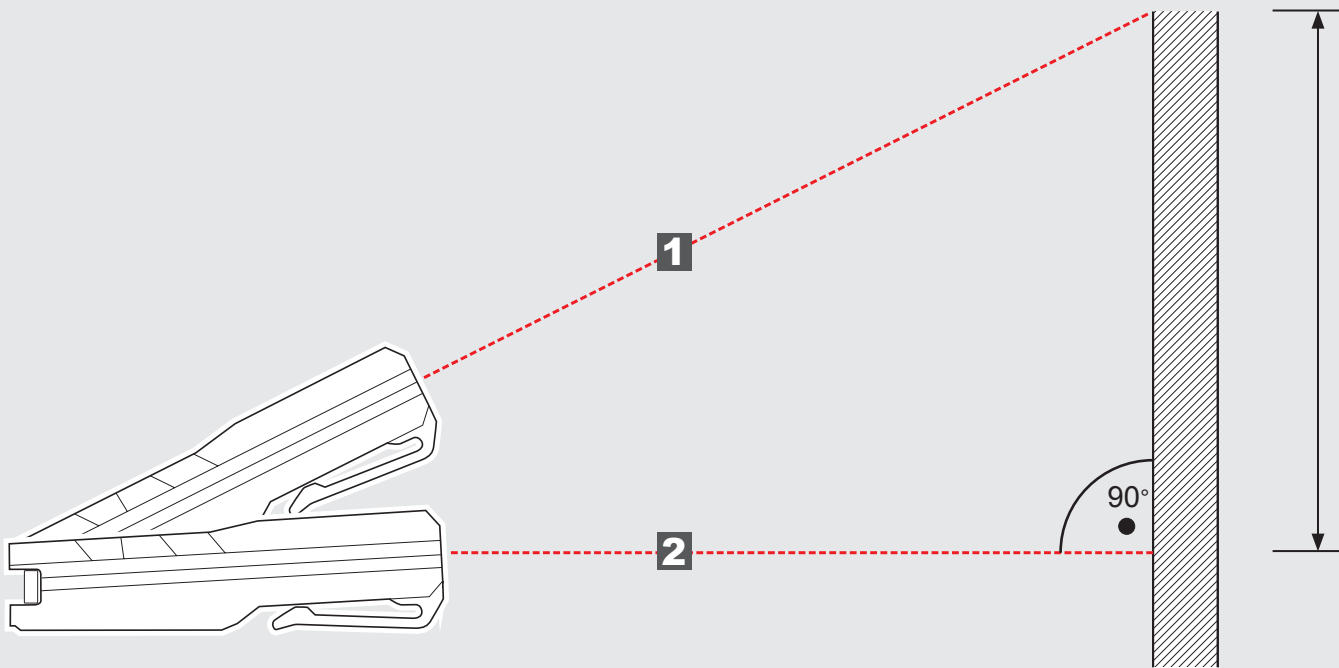
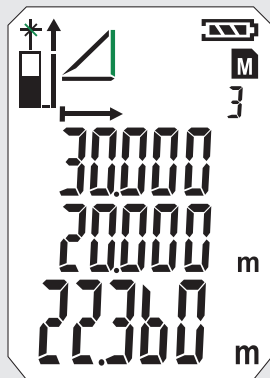
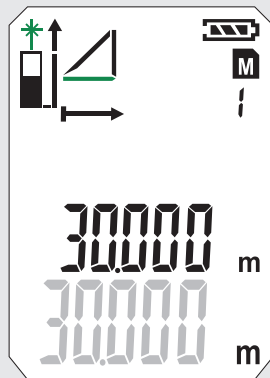
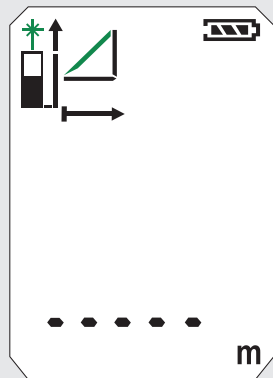
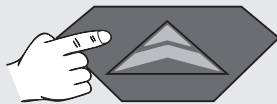

MISURAZIONE INDIRETTA (PITAGORA 2)

0



1

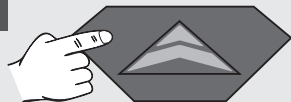

2



3

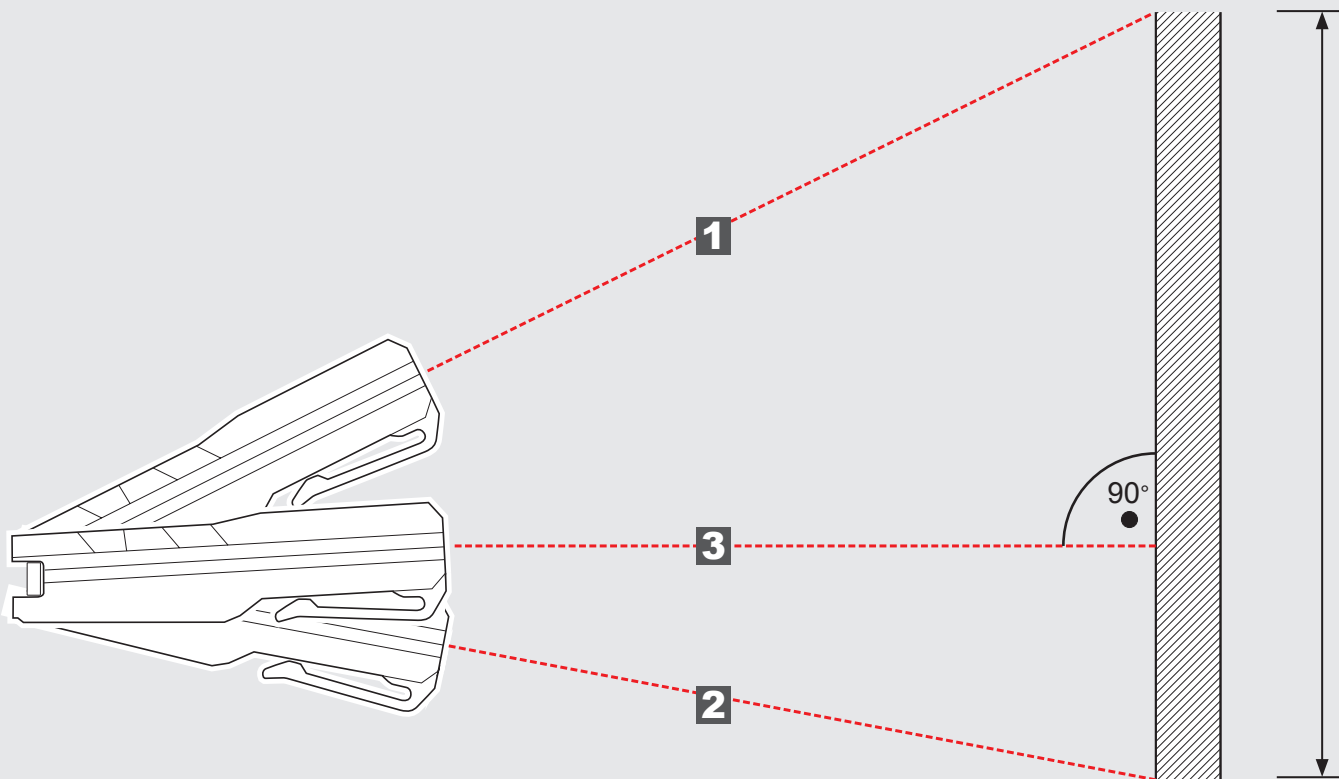
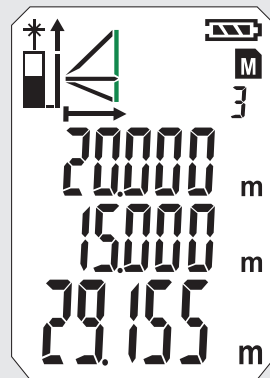
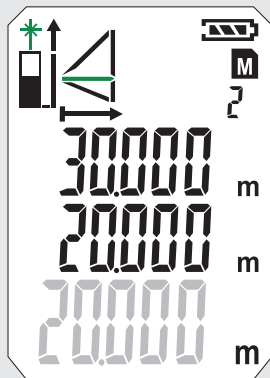
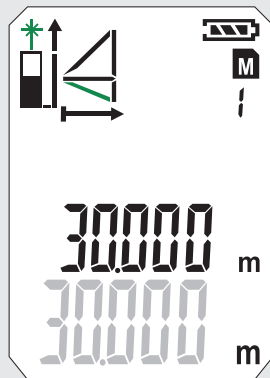
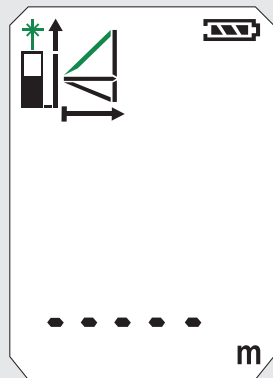

MISURAZIONE INDIRETTA (PITAGORA 3)

1

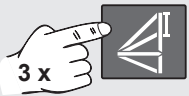

2

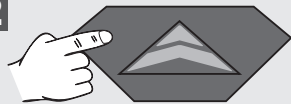



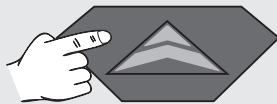

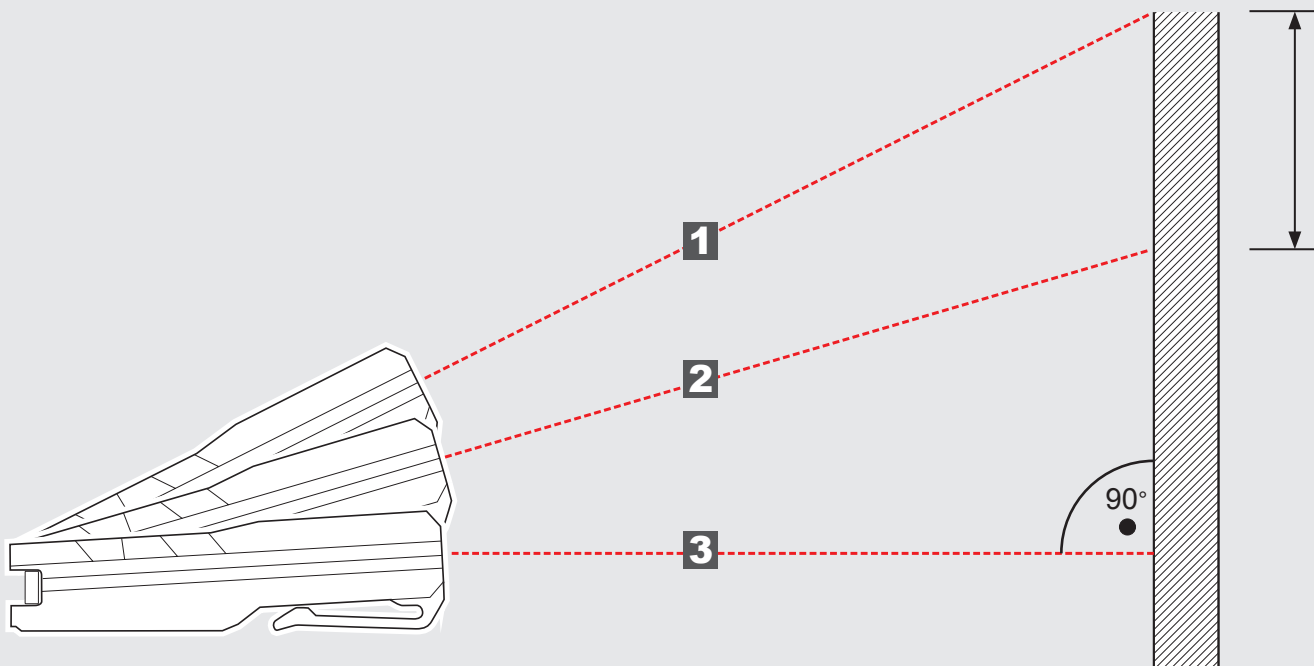
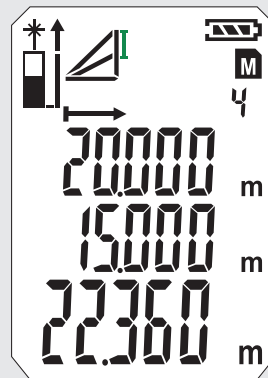
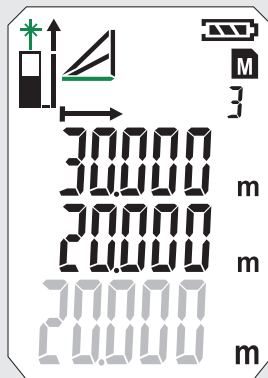
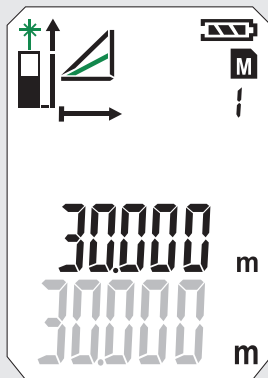
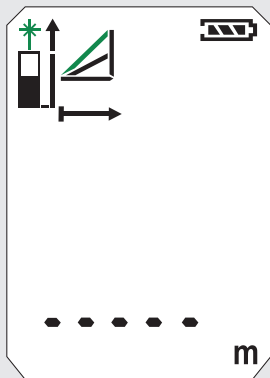
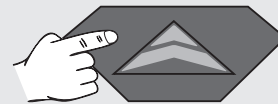

3





4

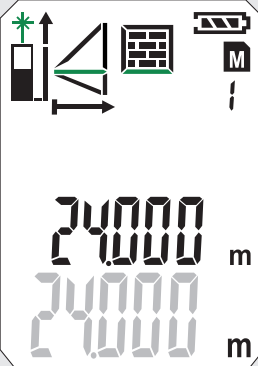
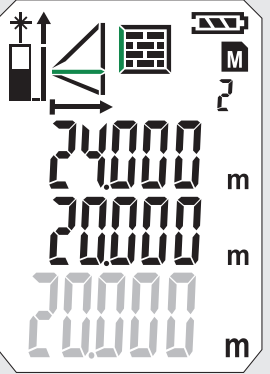
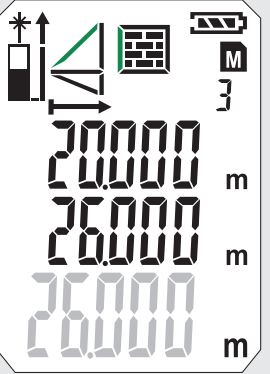
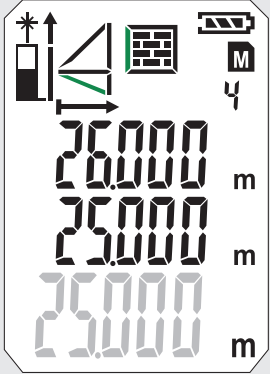

MISURAZIONE SUPERFICIE PARETE (SCENARIO 1)

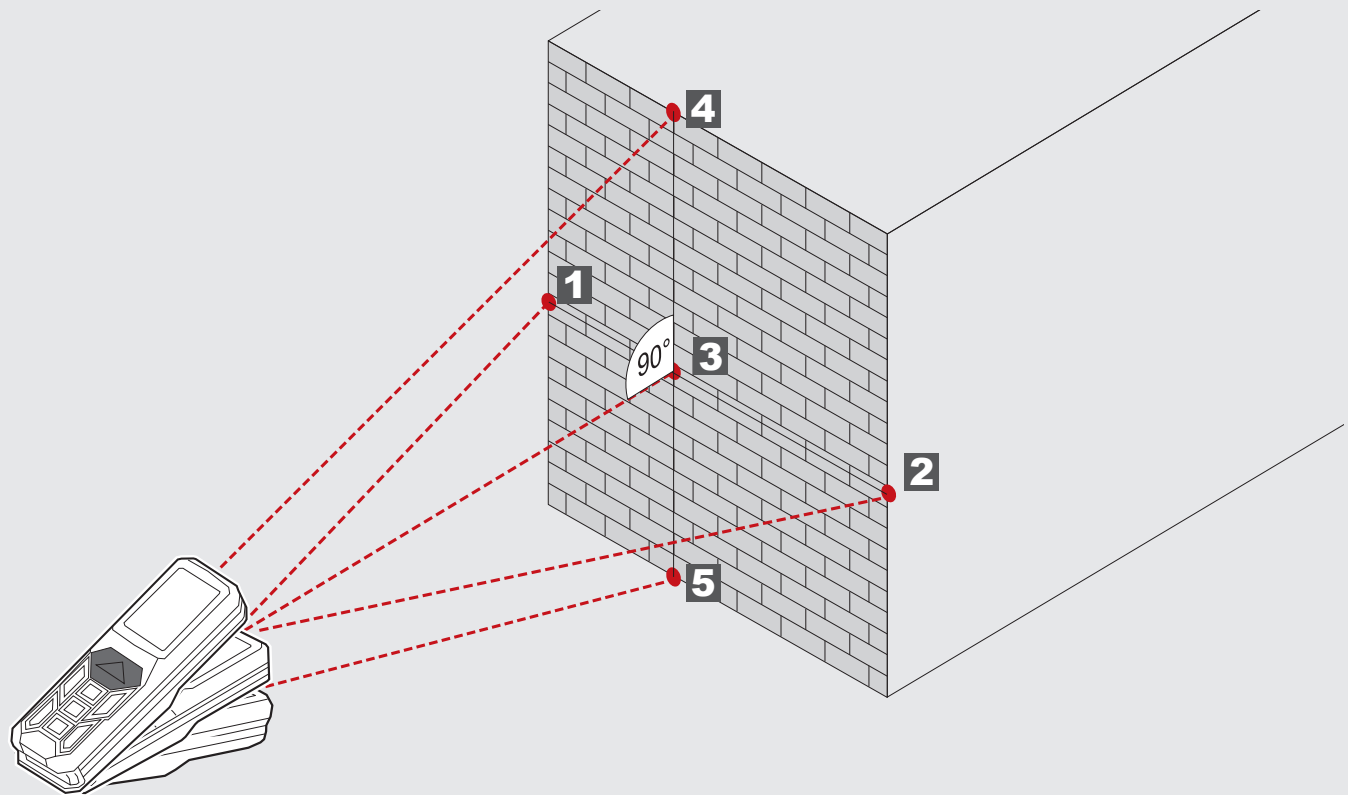





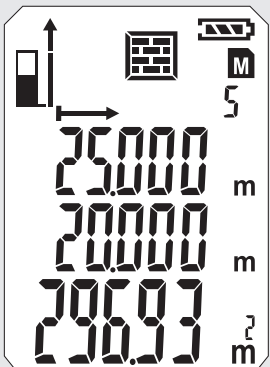



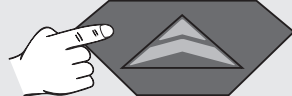
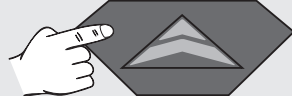

0 	1 	2 	3 	4 
				

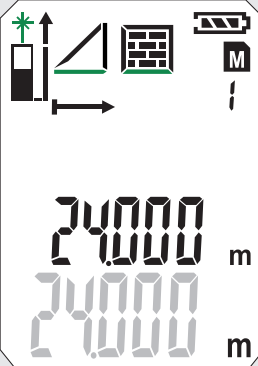

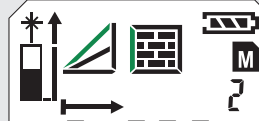
5



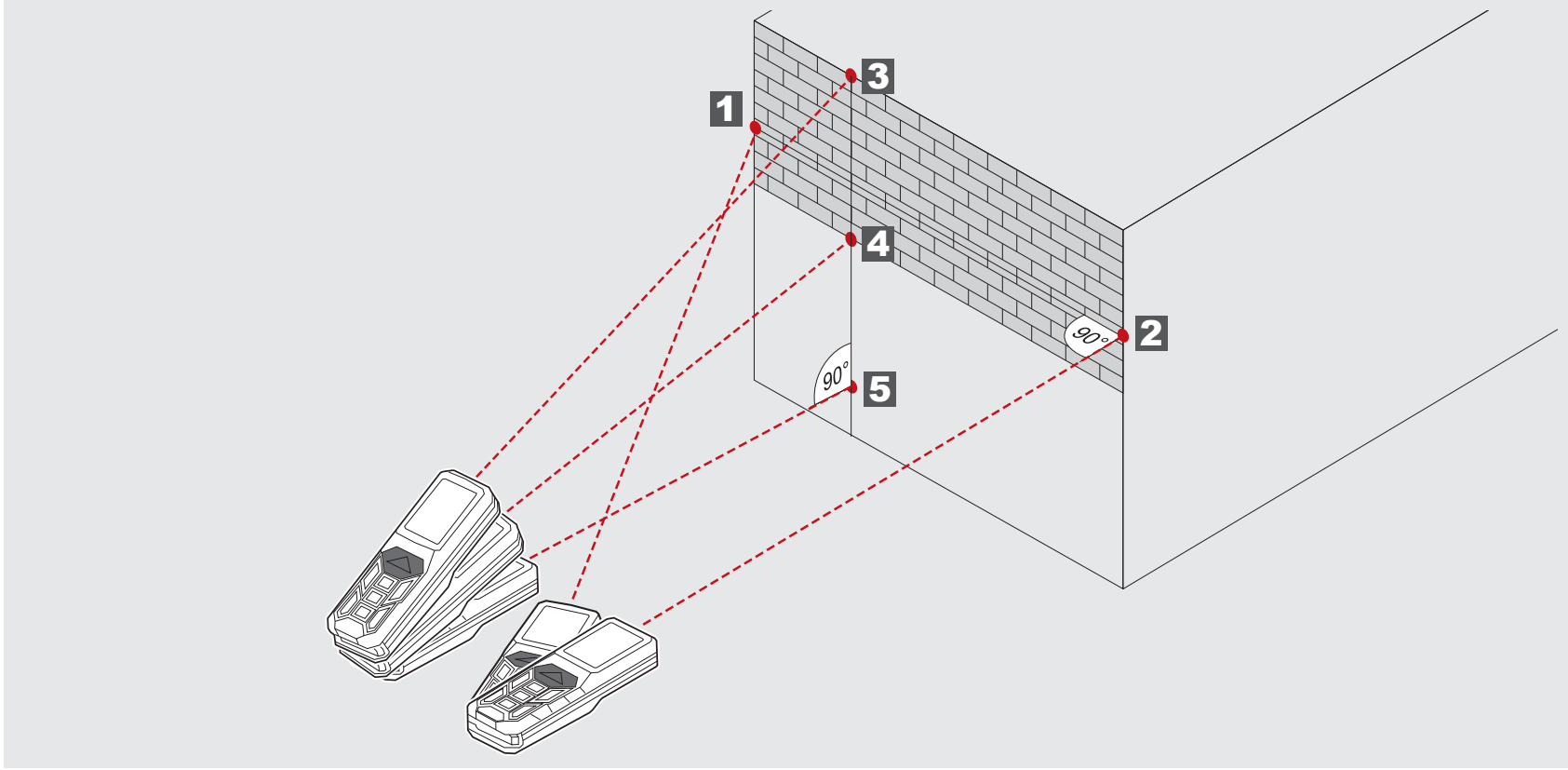

MISURAZIONE SUPERFICIE PARETE (SCENARIO 2)

0 	1 	2 	3 	4 
 	 	 	 	 



5



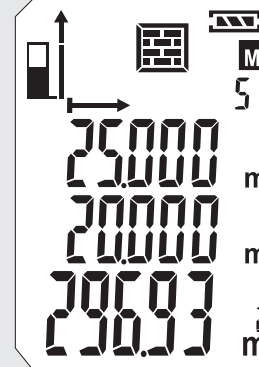



TIMER

Il timer permette di ritardare l'inizio della misurazione, ad es. per posizionare un componente nel raggio di misurazione.

Azionare il tasto 

- Appare il simbolo . Azionando il tasto  è possibile impostare il timer tra 3 e 15 sec.

Azionare il tasto 

- Parte il count-down fino alla misurazione.
- Raggiunto lo 0 viene attivata la misurazione.

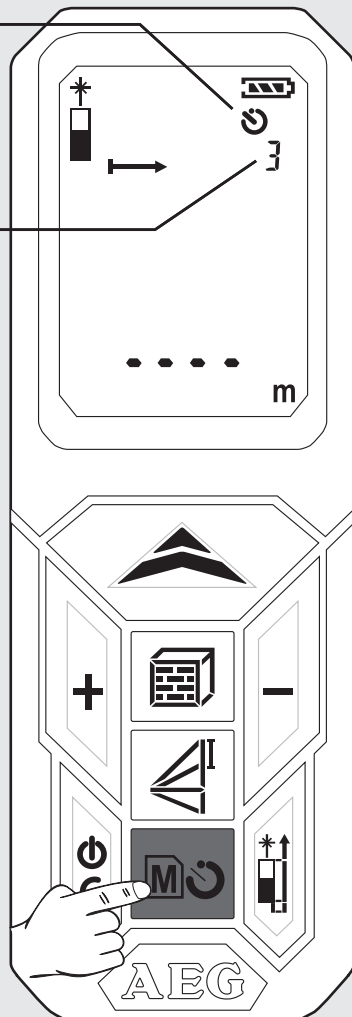

MEMORIA

I valori misurati vengono salvati automaticamente in memoria, in maniera progressiva.

I valori memorizzati possono essere chiamati con il tasto .

Tenere premuto il tasto  per 2 sec.

- Viene visualizzato il simbolo e lo spazio di memoria.
- Viene visualizzato il relativo parametro di misura.
- Il valore memorizzato viene visualizzato nella riga principale.
- Usare i tasti +/- per navigare

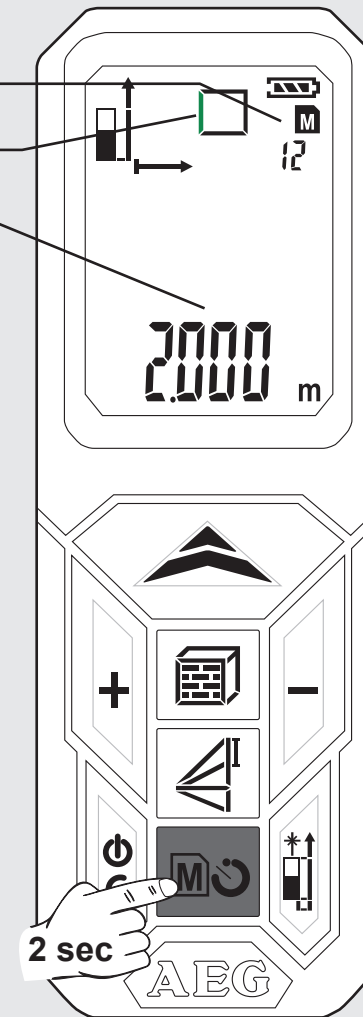



FUNZIONAMENTO DI BASE ESEMPLIFICATO PER LA MISURAZIONE DELLA SUPERFICIE (1)

1 Attivare

Azionare il tasto 
⚠ Attenzione! Raggio laser on!
 Non dirigere su persone!

Il simbolo laser lampeggia (lampeggio indicato verde).

2 Selezionare il piano di misura

Impostazione di default all'accensione: posteriore
 Premere 1x -> perno d'angolo
 Premere 2x -> anteriore
 Premere 3x -> posteriore

Viene visualizzato il simbolo

3 Selezionare la funzione

All'accensione il dispositivo è sempre impostato su misurazione lunghezza.
 premere 1x - misurazione superficie

- Viene visualizzato il simbolo
 - Lampeggia il parametro misurato (lampeggio indicato verde)

4 Misurare la lunghezza

Orientare il dispositivo e premere il tasto 

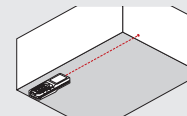

- Il valore misurato appare brevemente nella riga principale.
 - Dopo 1 sec. il valore misurato si sposta alla riga superiore.
 Il valore misurato viene memorizzato con numero progressivo.
 - Lampeggia il secondo parametro misurato. Il dispositivo è pronto per la misurazione del secondo valore.

5 Misurazione larghezza

Orientare il dispositivo e premere il tasto 

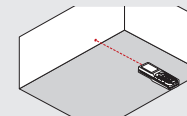

- Il valore misurato appare brevemente nella riga principale.
 - Dopo 1 sec. il valore misurato si sposta alla riga superiore.
 Il valore misurato viene memorizzato con numero progressivo.
 - Il risultato viene visualizzato nella riga principale e salvato in memoria con un numero progressivo.

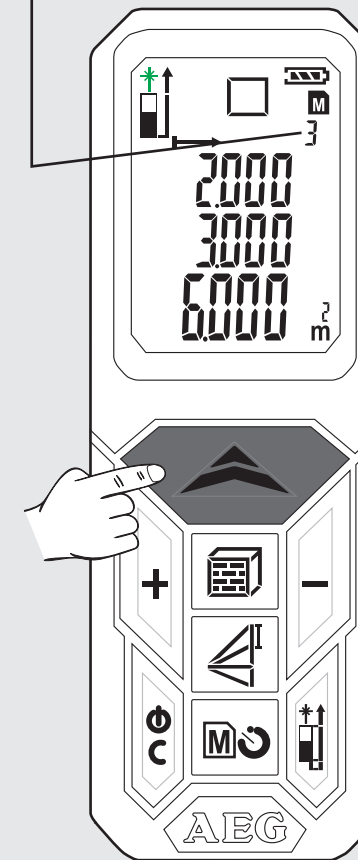
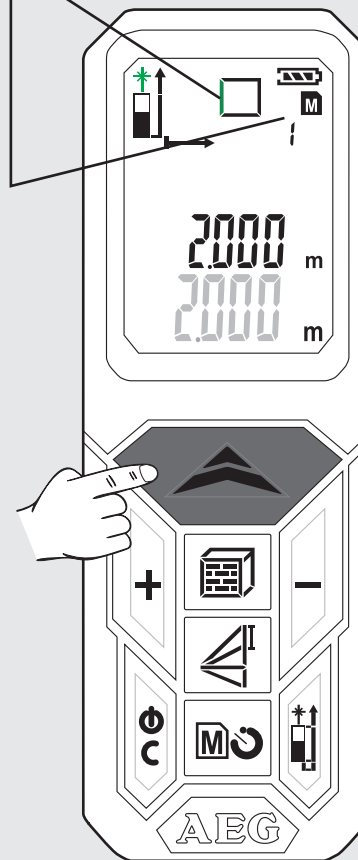
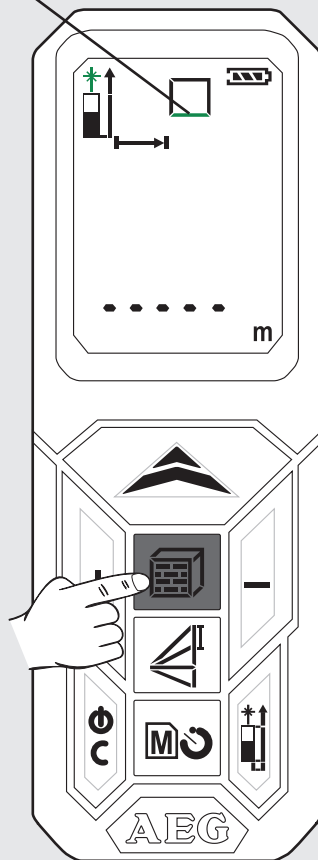
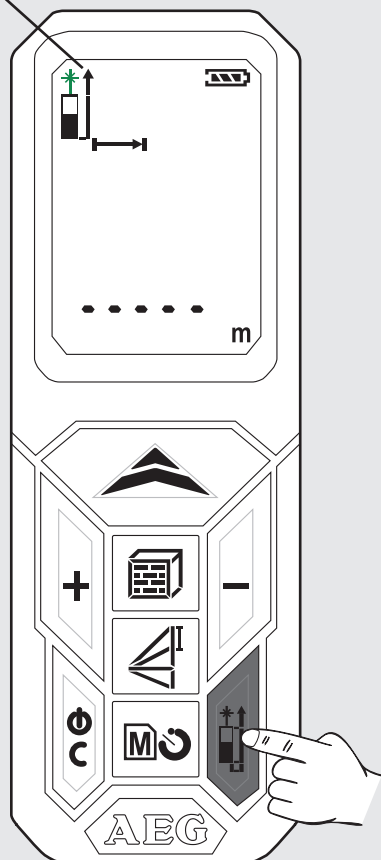
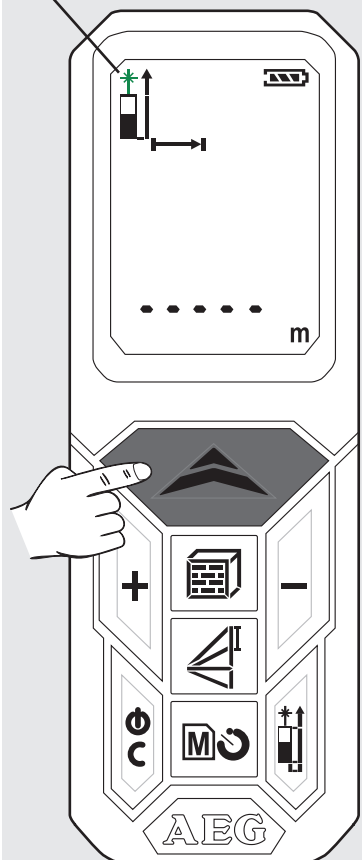

FUNZIONAMENTO DI BASE ESEMPLIFICATO PER LA MISURAZIONE DELLA SUPERFICIE (2)

6 Chiamare i valori salvati

Tenere premuto il tasto  per 2 sec.

Premere il tasto + o -

- I valori memorizzati vengono visualizzati nella riga principale.
- Viene visualizzato il relativo simbolo e lampeggia il parametro misurato (lampeggio indicato verde).

7 Uscire dalla memoria

Azionare il tasto 

8 Disattivare

Mantenere premuto il tasto  per 2 sec

(E' necessario uscire prima dalla memoria).

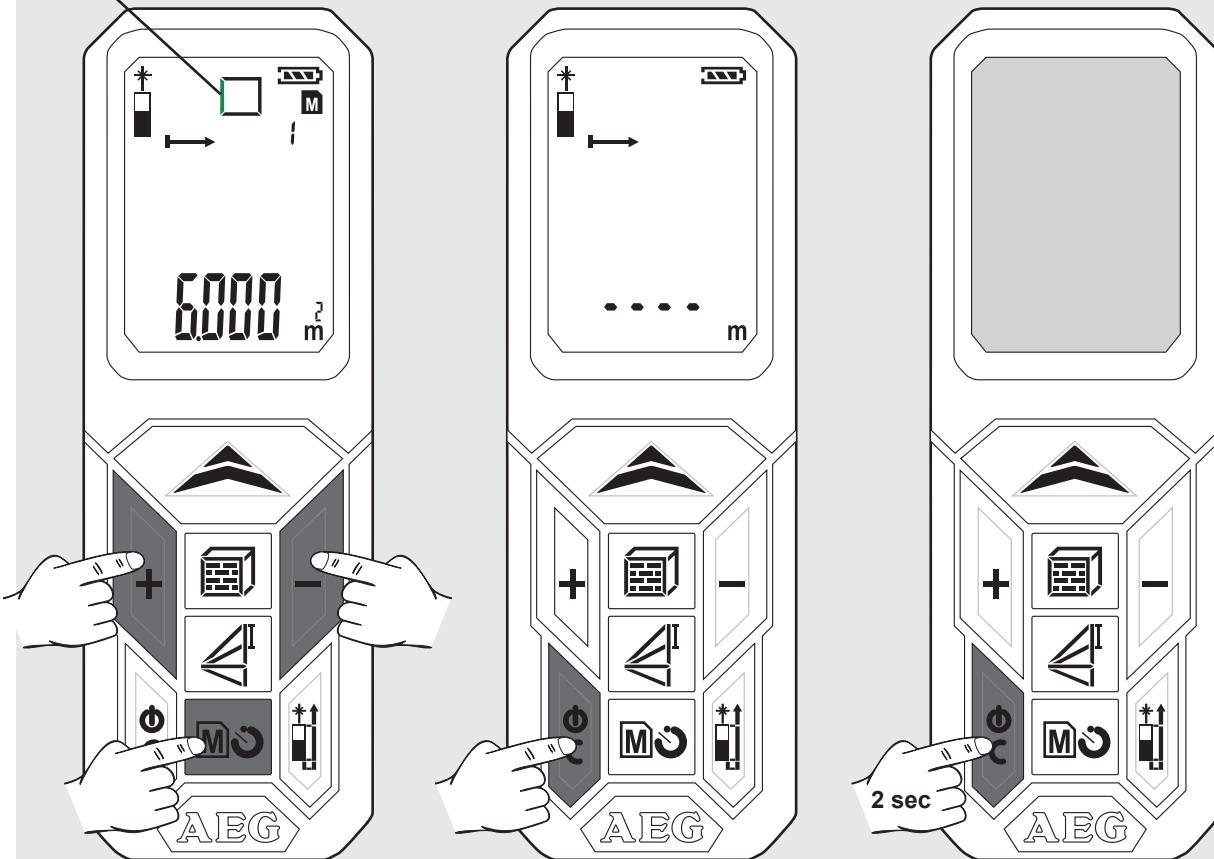

- Il dispositivo si spegne.
- Se per 3 minuti non verrà azionato alcun tasto, il dispositivo si spegnerà automaticamente.



CONTENIDO

Instrucciones de seguridad importantes.....	1
Datos técnicos.....	2
Aplicación de acuerdo a la finalidad.....	2
Tabla de códigos de error.....	2
Diagrama sinóptico.....	3
Cambiar baterías.....	4
Punta de ángulos.....	4
Sujeción del cinturón.....	4
Tecla de función, Pitágoras, plano de medición.....	5
Medición de longitud simple.....	6
Medición continua / Medición mínima - máxima.....	7
Medición de adición / sustracción.....	8
Medición de superficies.....	9
Medición de volumen.....	10
Medición indirecta (Pitágoras 1).....	11
Medición indirecta (Pitágoras 2).....	12
Medición indirecta (Pitágoras 3).....	13
Medición de superficies de paredes (escenario 1).....	14
Medición de superficies de paredes (escenario 2).....	15
Temporizador.....	16
Memoria.....	16
Funcionamiento básico poniendo como ejemplo una medición de superficies (1).....	17
Funcionamiento básico poniendo como ejemplo una medición de superficies (2).....	18

INSTRUCCIONES DE SEGURIDAD IMPORTANTES

  Lea detenidamente las Instrucciones de seguridad y el Manual de empleo que se encuentran en el CD adjunto antes de empezar a trabajar con el producto.

Clasificación de láser

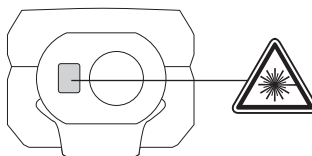

ADVERTENCIA:

El producto corresponde a la Clase de láser 2 según la norma IEC 60825-1:2007.



Etiquetado

Tape el texto en inglés en la placa indicadora de potencia antes de la puesta en funcionamiento con la etiqueta suministrada en el idioma de su país.

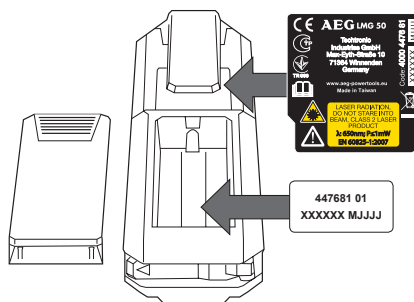

Advertencia:

Evite el contacto directo con los ojos. Debido a la intensa brillantez del rayo láser se puede producir un deslumbramiento durante un breve periodo de tiempo.

Absténgase de mirar directamente al rayo láser y no dirija éste a otras personas.

No deslumbrar intencionadamente a terceros.

Advertencia:

No hacer funcionar el aparato láser cerca de niños o permitir a los niños que utilicen el aparato láser.

¡Atención! Una superficie reflectante podría dirigir el rayo láser de vuelta hacia el operador o hacia otra persona.

Respetar una distancia de seguridad de las partes móviles.

Realizar periódicamente mediciones de control. Especialmente cuando el producto ha estado sometido a esfuerzos excesivos así como antes y después de tareas de medición importantes.

Pueden producirse medidas erróneas si se utiliza un producto que esté defectuoso, después de haberse caído o haber sido objeto de transformaciones no permitidas.

Atención! Familiarícese con los elementos de manejo y el uso reglamentario del aparato para jardín.

El aparato de medición por láser tiene un campo de aplicación limitado. (Véase capítulo "Datos técnicos"). Los intentos de medir fuera del rango máximo y mínimo ocasionan inexactitudes. El uso en condiciones meteorológicas adversas como por ejemplo demasiado calor, demasiado frío, luz solar brillante, lluvia, nieve, niebla u otras condiciones que limitan la visión, pueden producir mediciones inexactas.

Si el aparato de medición por láser se lleva de un ambiente cálido a un ambiente frío (o al revés), espere hasta que el aparato se haya adaptado a la nueva temperatura ambiente

Guardar el aparato de medición por láser siempre en el interior de locales, proteger el aparato contra sacudidas y vibraciones o temperaturas extremas

Proteger el aparato de medición por láser siempre contra polvo, humedad y alta humedad del aire. Esto puede destruir los componentes internos o influir en la exactitud.

No utilice detergentes o disolventes agresivos. Limpiar solamente con un paño limpio y blando.

Evite golpes fuertes sobre el aparato de medición por láser o la caída del mismo. Se debería comprobar la exactitud del aparato, si éste se ha caído o si ha estado expuesto a otras cargas mecánicas.

Las reparaciones necesarias en este aparato láser deben ser realizadas únicamente por personal especializado y autorizado.

No utilizar el producto en áreas con una atmósfera potencialmente explosiva o volátil.

Utilice sólo los cargadores recomendados por el fabricante para cargar las baterías.



Las pilas vacías no deben eliminarse con la basura doméstica. Cuide el medio ambiente y llévelas a los puntos de recogida disponibles de conformidad con las regulaciones nacionales y locales. No desechar el producto con la basura doméstica.

Desechar el producto correctamente. Cumplir con las normas de desecho específicas del país. Respetar la normativa específica nacional y local. Póngase en contacto con la autoridad local competente o con la tienda en la que adquirió el producto para obtener información acerca de la eliminación correcta.



Marca CE

DATOS TÉCNICOS

Clase de protección	IP54 (protegido contra el polvo y las salpicaduras de agua)
Sistema óptico	14 mm
Foco	35 mm
Rango máximo de medición	50 metros (tolerancia 55m)
Rango mínimo de medición	0,05 metros
Exactitud absoluta @ < 10m	± 1,5 mm (máx.)
Precisión de repetición @ < 10m	± 1,5 mm (valor típico como máx. 2σ)
Precisión de repetición @ > 10m	Aumento ± 0,25 mm / metros (valor típico como máx. 2σ)
Tiempo de medición	0,5 s
Tipo de display	LCD (22,7 mm x 31 mm)
Alimentación de corriente	AAA 2x (batería alcalina)
Vida útil de la batería	10000 (medición individual)
Potencia de salida del láser	0,6 mW ~ 0,95 mW (Clase 2, 650nm)
Tamaño del punto creado por el láser	25 x 30 mm @ 16 m (máx.)
Ángulo vertical del rayo láser	+1 grado
Ángulo horizontal del rayo láser	±1 grado
Desconexión automática del aparato	180 segundos
Desconexión automática del láser	30 segundos
Rango de temperatura de trabajo	-10°C a +50°C
Rango de temperatura de almacenamiento	-25°C a +70°C
Peso sin batería	80 g

APLICACIÓN DE ACUERDO A LA FINALIDAD

El aparato de medición por láser es apropiado para la medición de distancias e inclinaciones. No utilice este producto para ninguna otra aplicación que no sea su uso normal.

TABLA DE CÓDIGOS DE ERROR

Código	Descripción	Solución
Err01	Fuera del rango de medición	Realizar una medición dentro del rango previsto.
Err02	La señal reflejada es demasiado débil	Elegir una superficie mejor.
Err03	Fuera del rango de indicación (valor máx.: 99.999) por ej. el resultado de la superficie y del volumen está fuera del rango de indicación	Comprobar, si los valores y los pasos son correctos.
Err04	Error en el cálculo de Pitágoras	Comprobar, si los valores y los pasos son correctos.
Err05	Batería débil	Insertar baterías nuevas.
Err06	Fuera del rango de temperatura de trabajo	Realizar la medición dentro del rango de temperatura de trabajo previsto.
Err07	La luz ambiente es demasiado brillante	Oscurecer la zona de interés.

Pitágoras
Diferencia de altura

Plano de medición

Medición de longitud

Mínimo / Máximo para medición continua

Adición / Sustracción

ENCENDER / MEDIR

- ▶ Encender
- ▶ Medir
- ▶ Medición continua (apretar 2 segundos)
Función mín. / máx.

ADICIÓN

- ▶ Sumar el valor
- ▶ Navegar en la memoria

SUPERFICIE / VOLUMEN

- ▶ Superficie (apretar 1 vez)
- ▶ Volumen (apretar 2 veces)
- ▶ Medición indirecta de superficies (apretar 3 / 4 veces)

ENCENDER

- ▶ Encender
- ▶ Apagar (apretar 2 segundos)
- ▶ Reponer

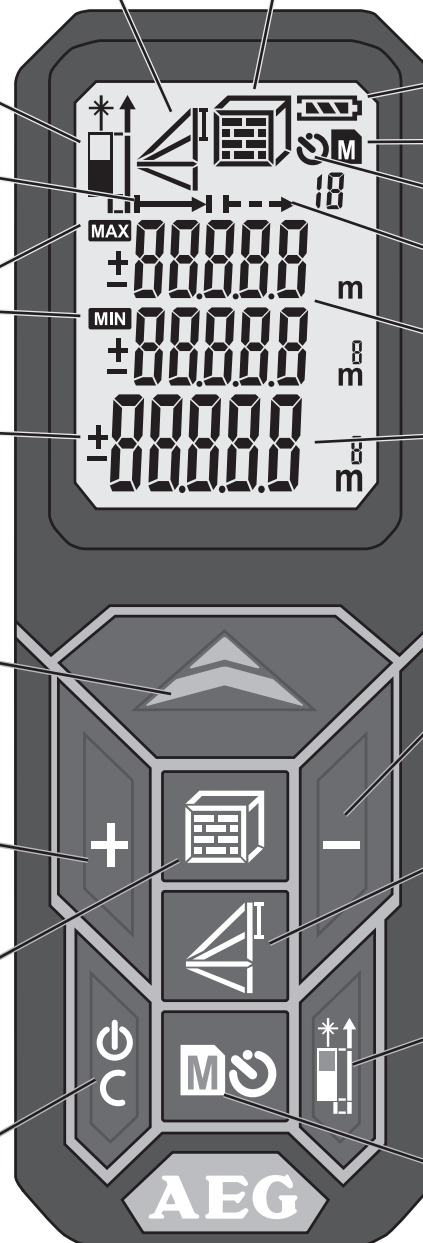

Superficie / Volumen
Medición indirecta de superficies

Estado de carga de la batería

Memoria

Temporizador

Medición continua

Valores intermedios

Valor total

SUSTRACIÓN

- ▶ Restar el valor
- ▶ Navegar en la memoria

PITÁGORAS

- ▶ Pitágoras 1 (apretar 1 vez)
- ▶ Pitágoras 2 (apretar 2 veces)
- ▶ Pitágoras 3 (apretar 3 veces)

CAMBIAR PLANO DE MEDICIÓN

- ▶ Delante
- ▶ Atrás
- ▶ Punta de ángulos

MEMORIA

- ▶ Temporizador 3-15 segundos (apretar 1 vez)
- ▶ Memoria 1-20 (apretar 1 vez 2 segundos)
- ▶ Navegar con las teclas +/- en la memoria

CAMBIAR BATERÍAS

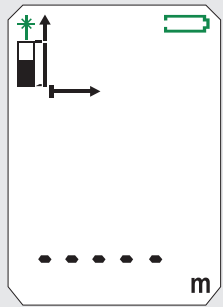

Si parpadea el símbolo, cambiar las baterías.

1

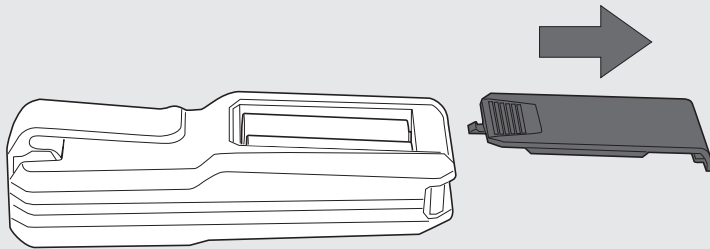

2

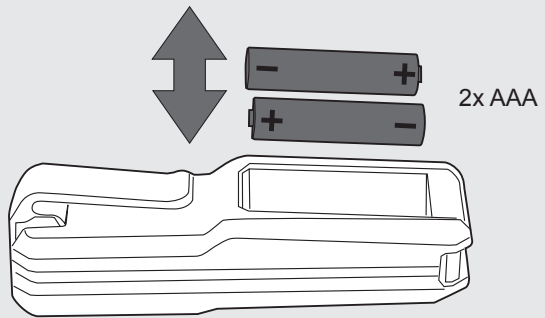

3

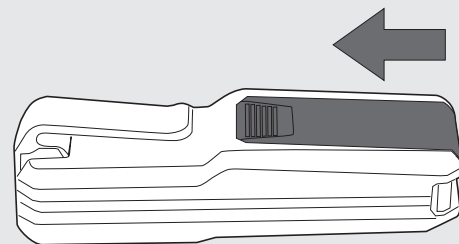

PUNTA DE ÁNGULOS

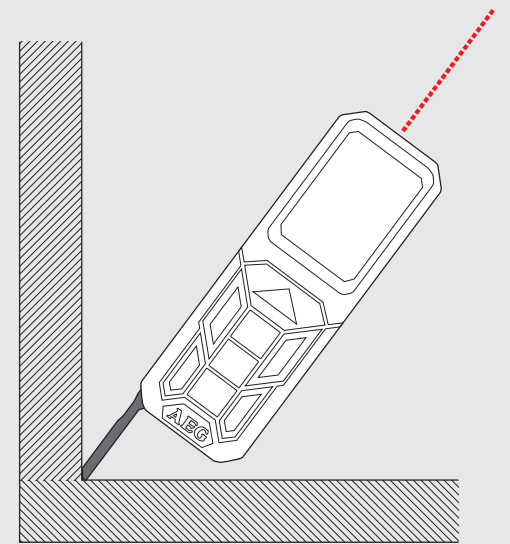
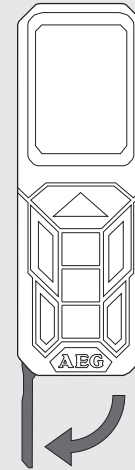

SUJECIÓN DEL CINTURÓN

1

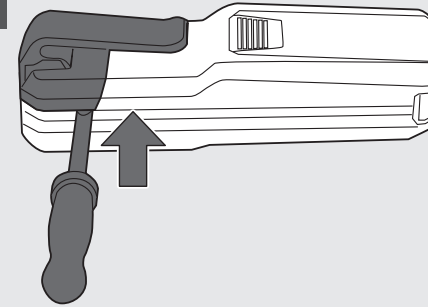

2

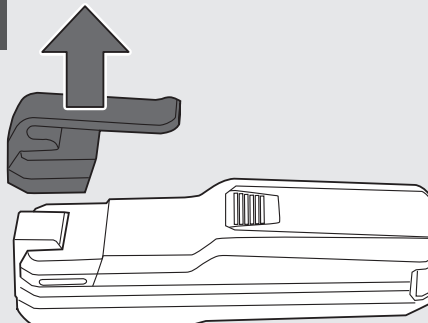

3

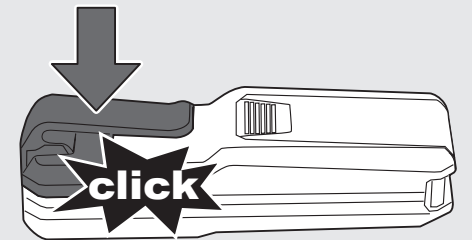

TECLA DE FUNCIÓN, PITÁGORAS, PLANO DE MEDICIÓN

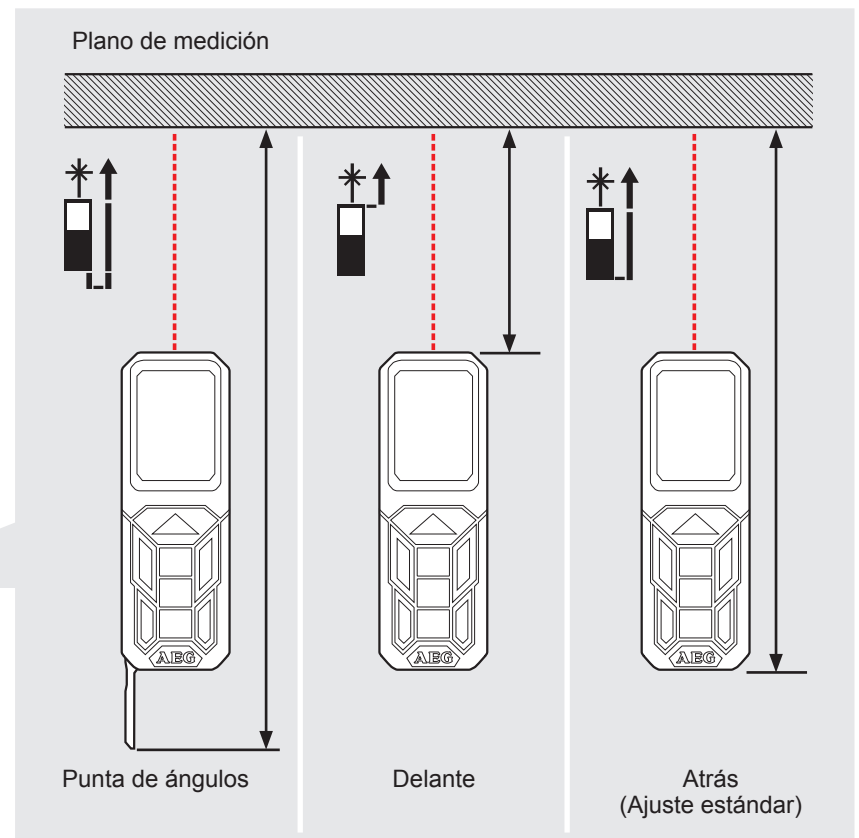
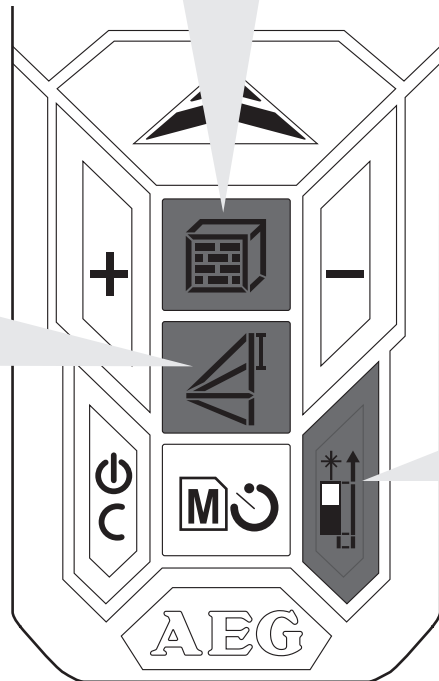
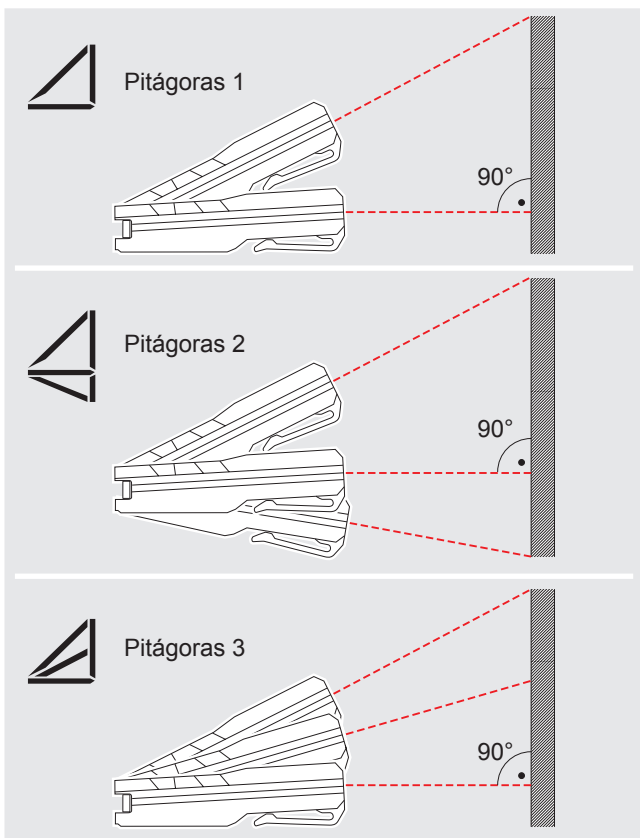
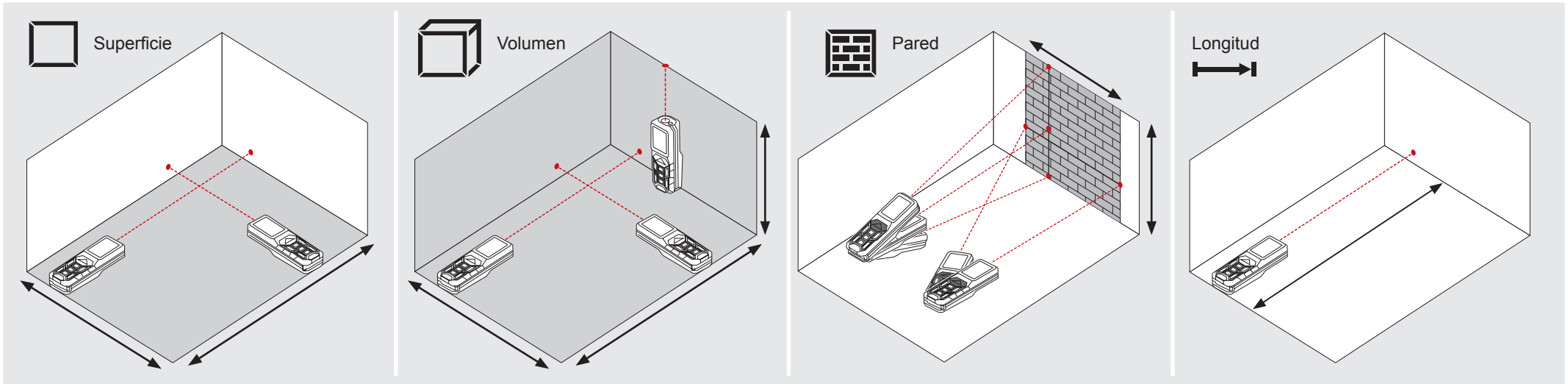

MEDICIÓN DE LONGITUD SIMPLE

0

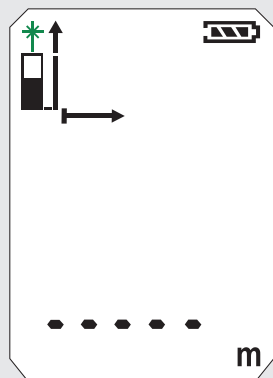

1

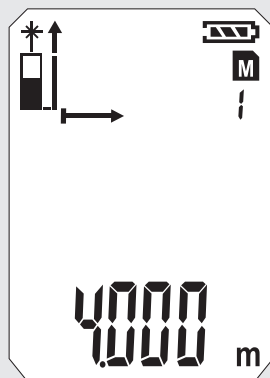
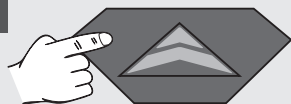

2

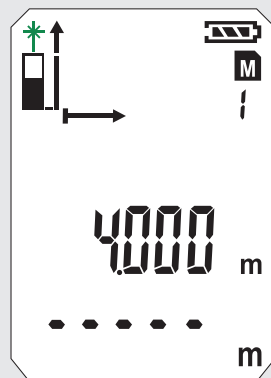
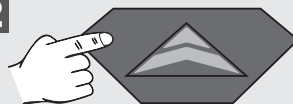

3

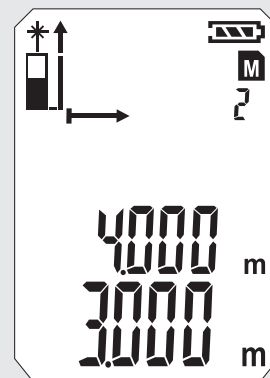
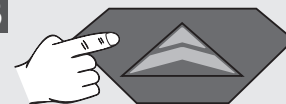

4

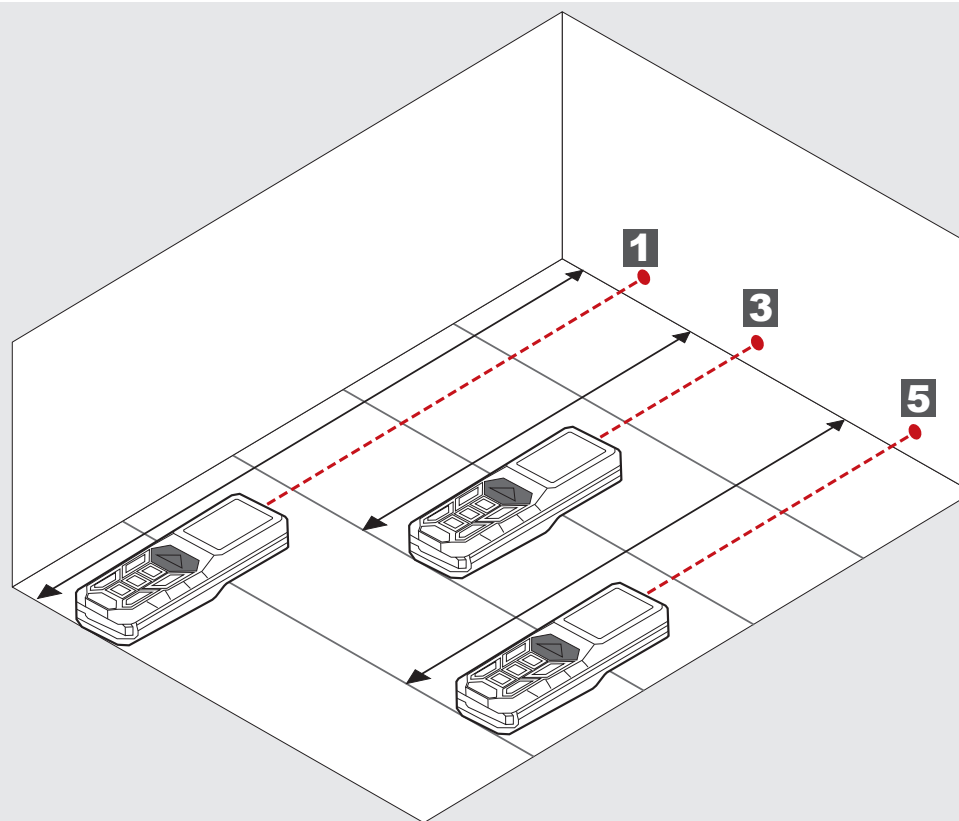
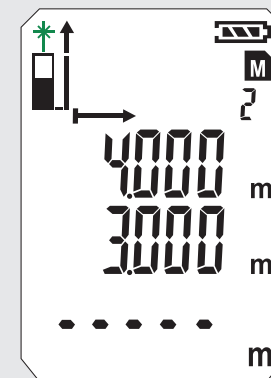
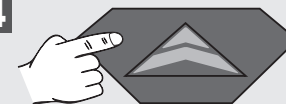

5

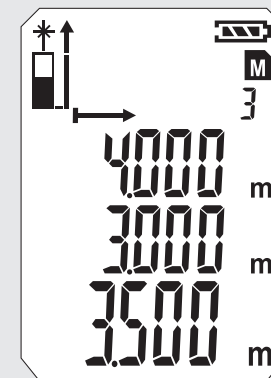
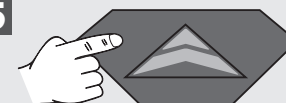

MEDICIÓN CONTINUA / MEDICIÓN MÍNIMA - MÁXIMA

0

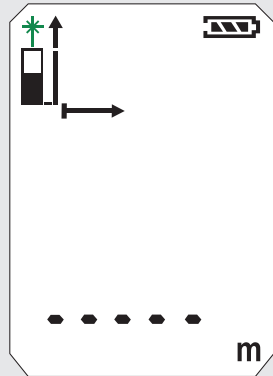

1

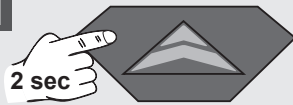

2 sec

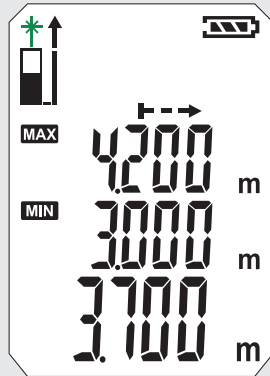

2

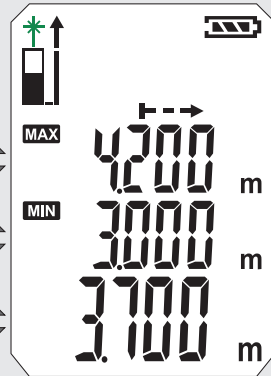
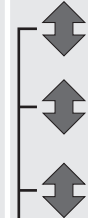

3

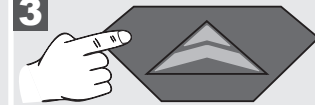

Stop
MIN / MAX

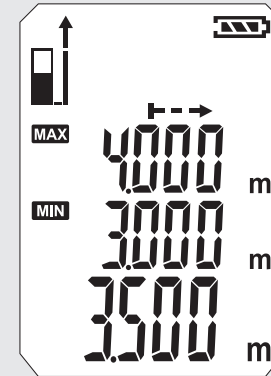

4

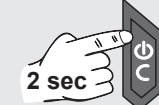

2 sec

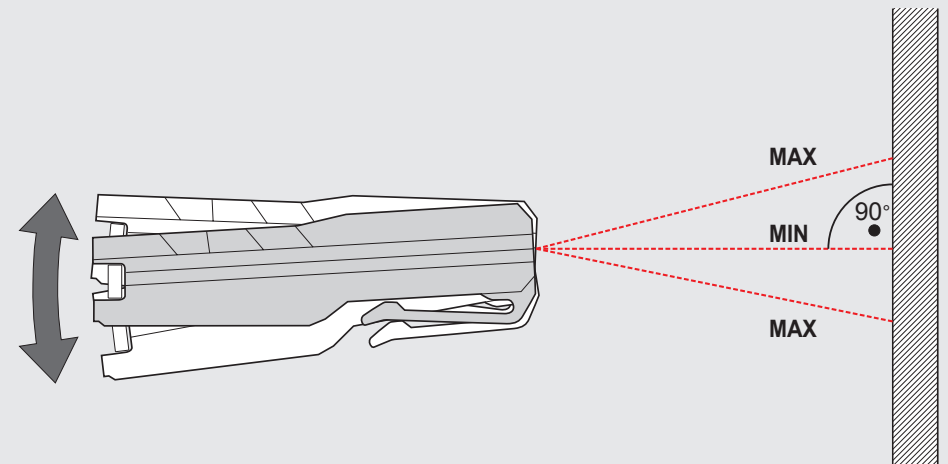
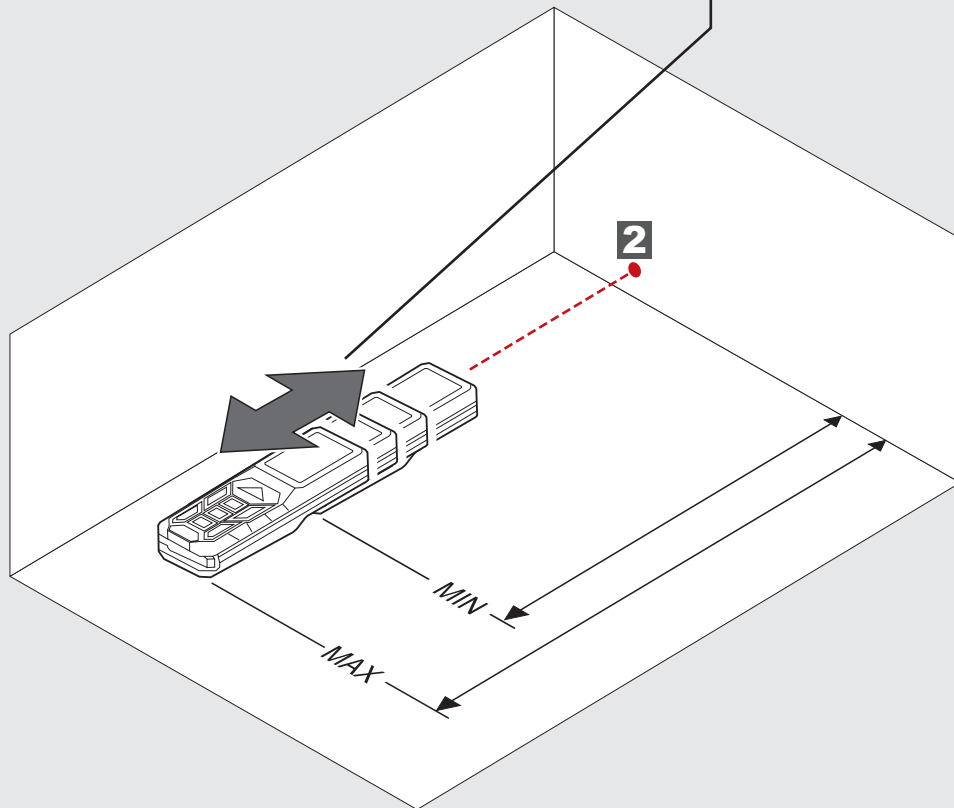
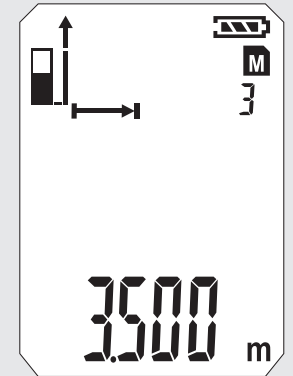

0

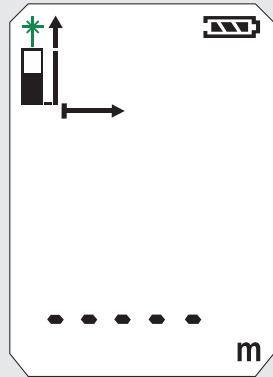

1

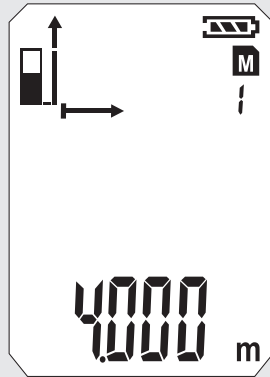
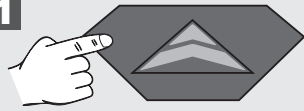

2

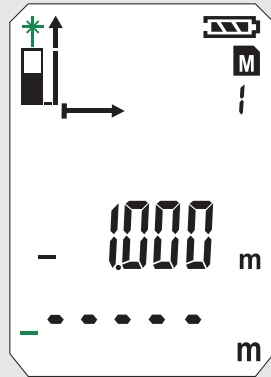
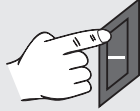

3

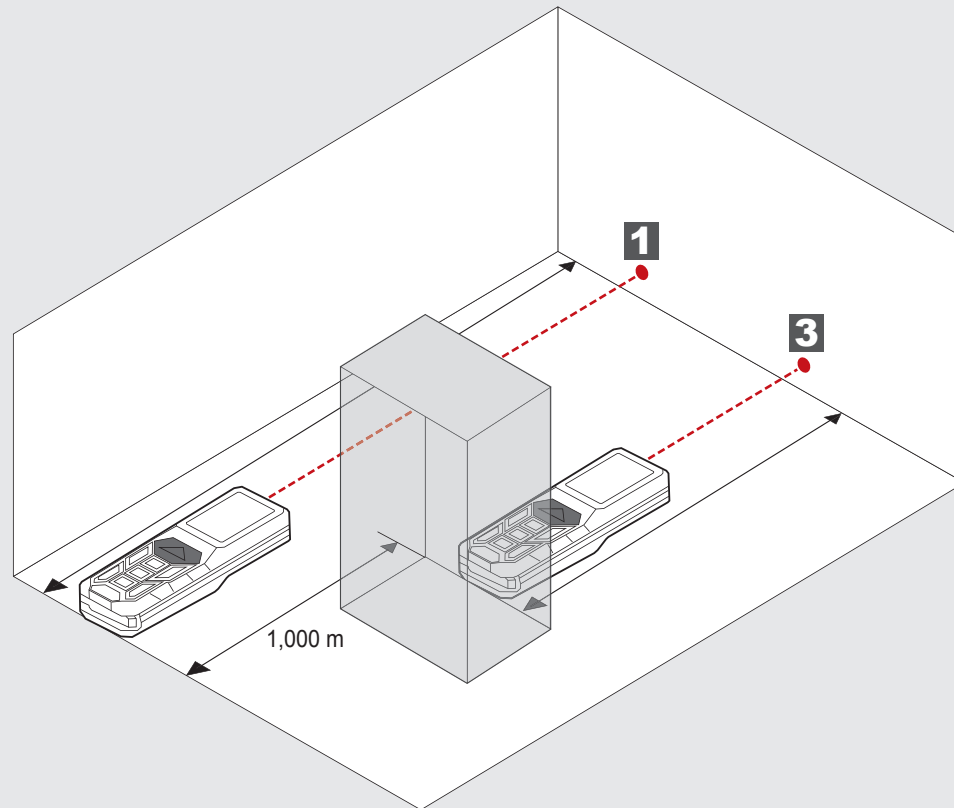
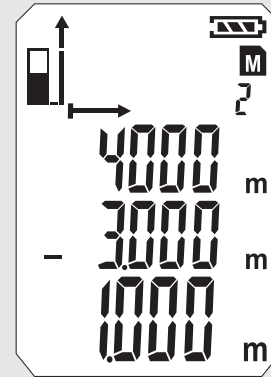
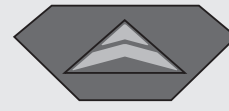

MEDICIÓN DE SUPERFICIES

0



1

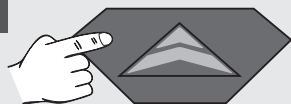

2

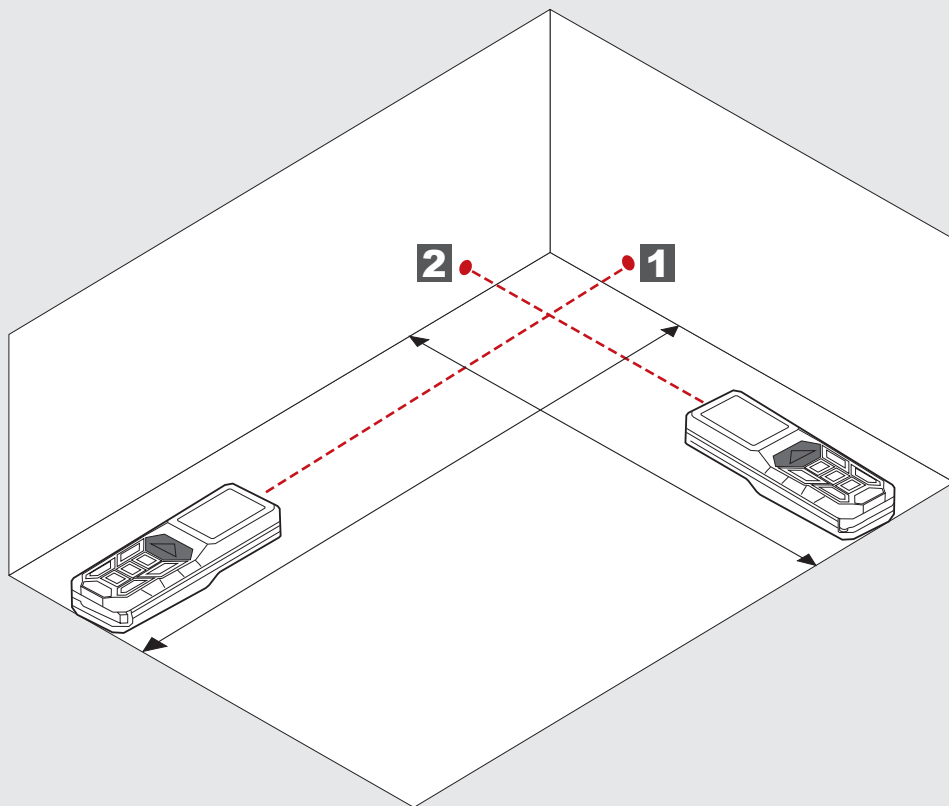
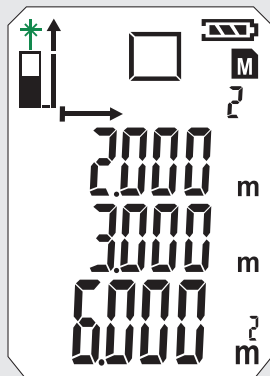
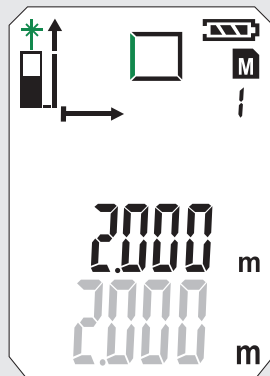
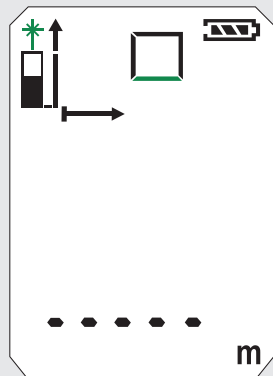
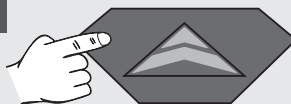

MEDICIÓN DE VOLUMEN

0

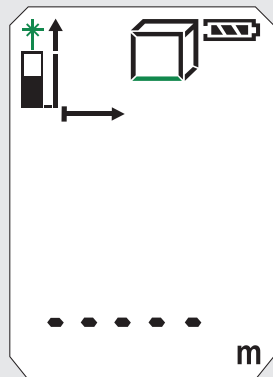

1

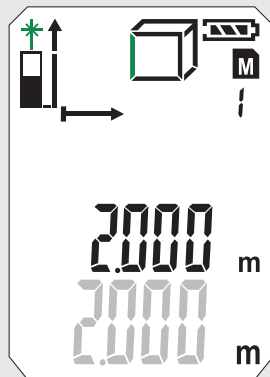
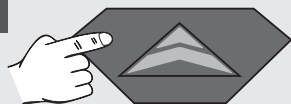

2

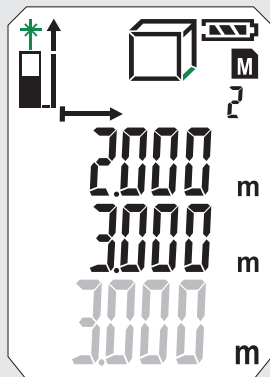
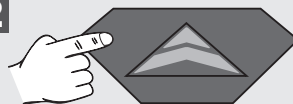

3

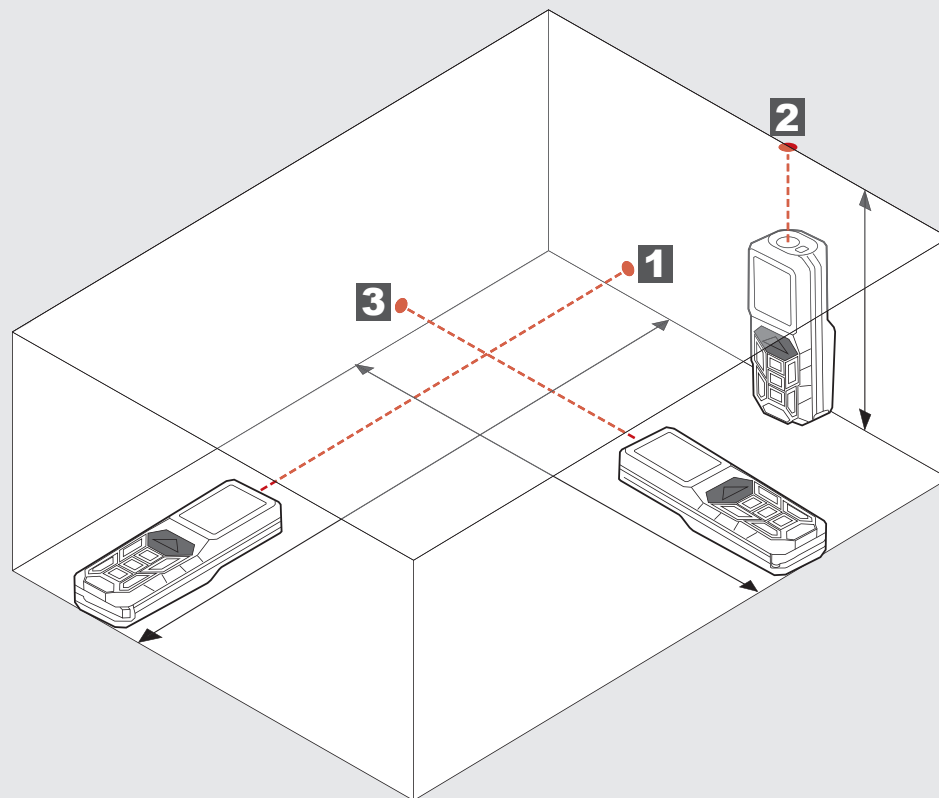
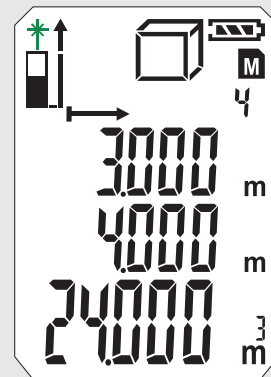
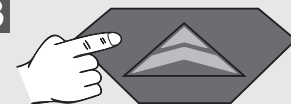

MEDICIÓN INDIRECTA (PITÁGORAS 1)

0



1

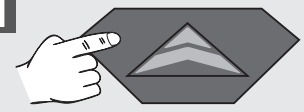

2

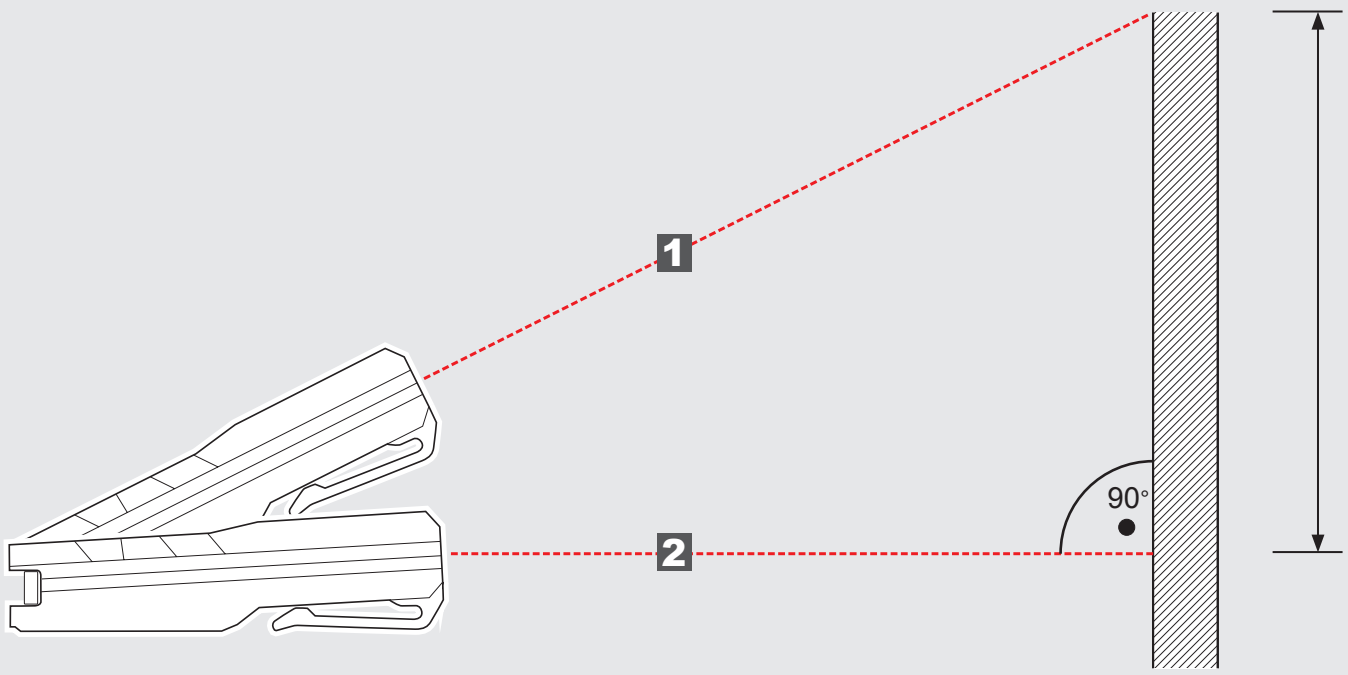
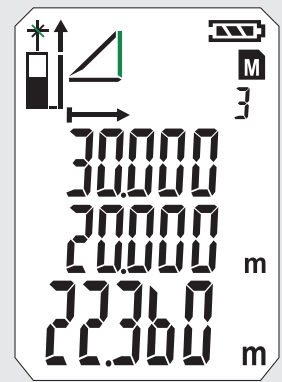
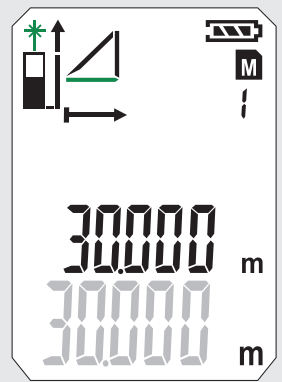
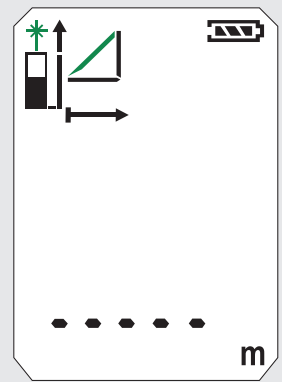
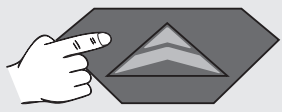

MEDICIÓN INDIRECTA (PITÁGORAS 2)

0



1

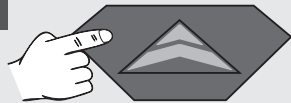

2

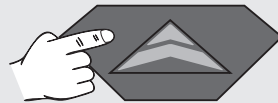

3

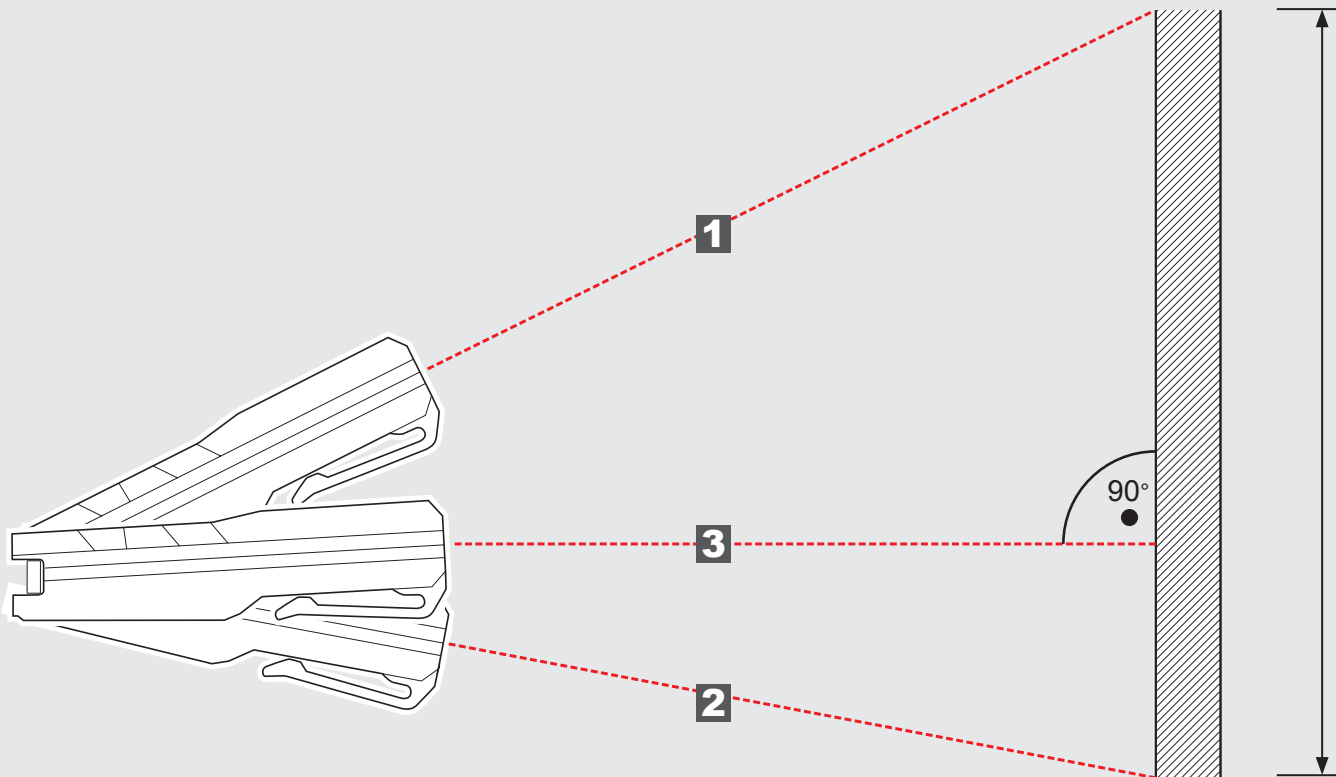
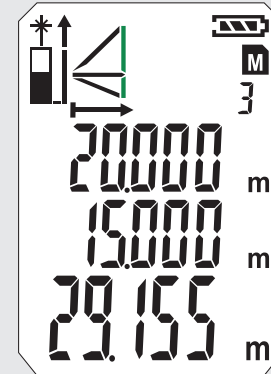
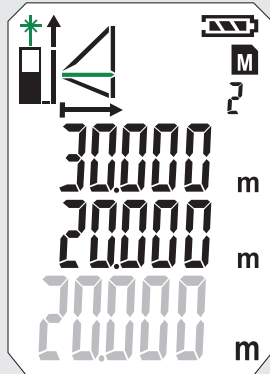
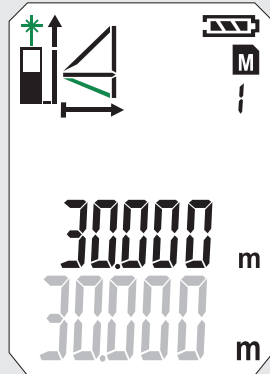
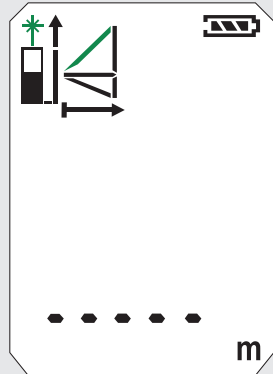
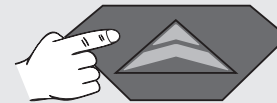

MEDICIÓN INDIRECTA (PITÁGORAS 3)

1



2

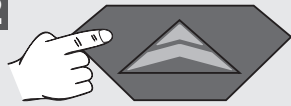



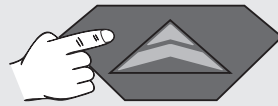

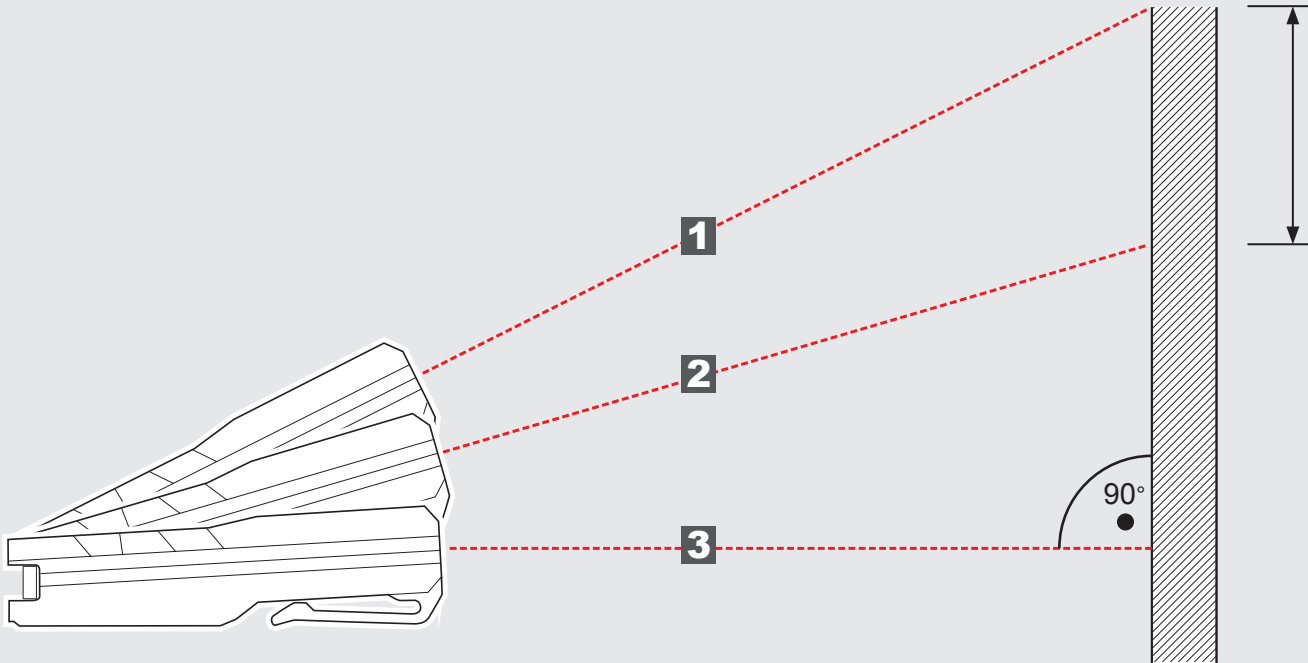
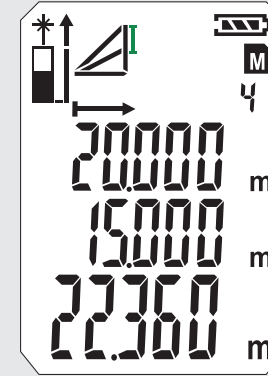
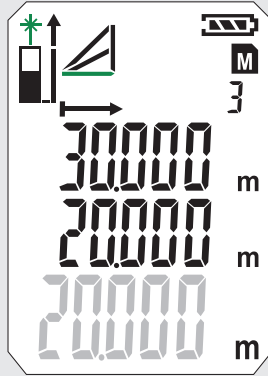
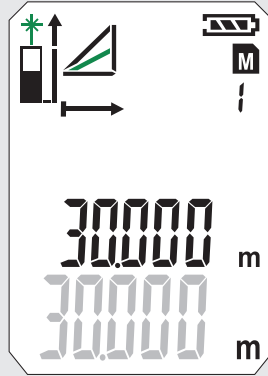
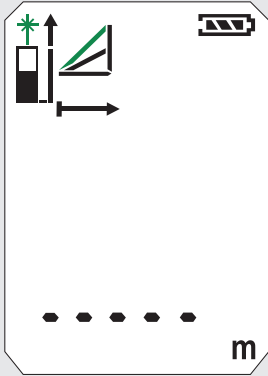
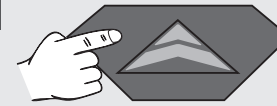

3





4



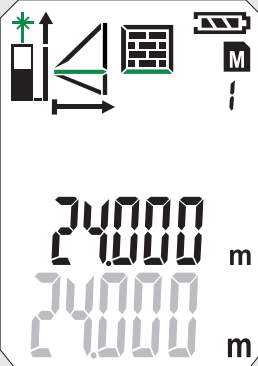
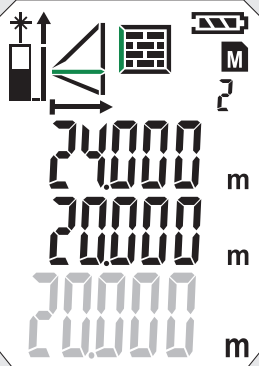
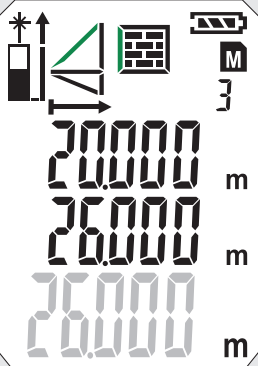
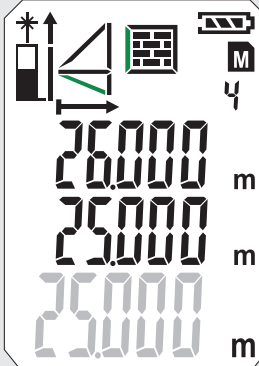

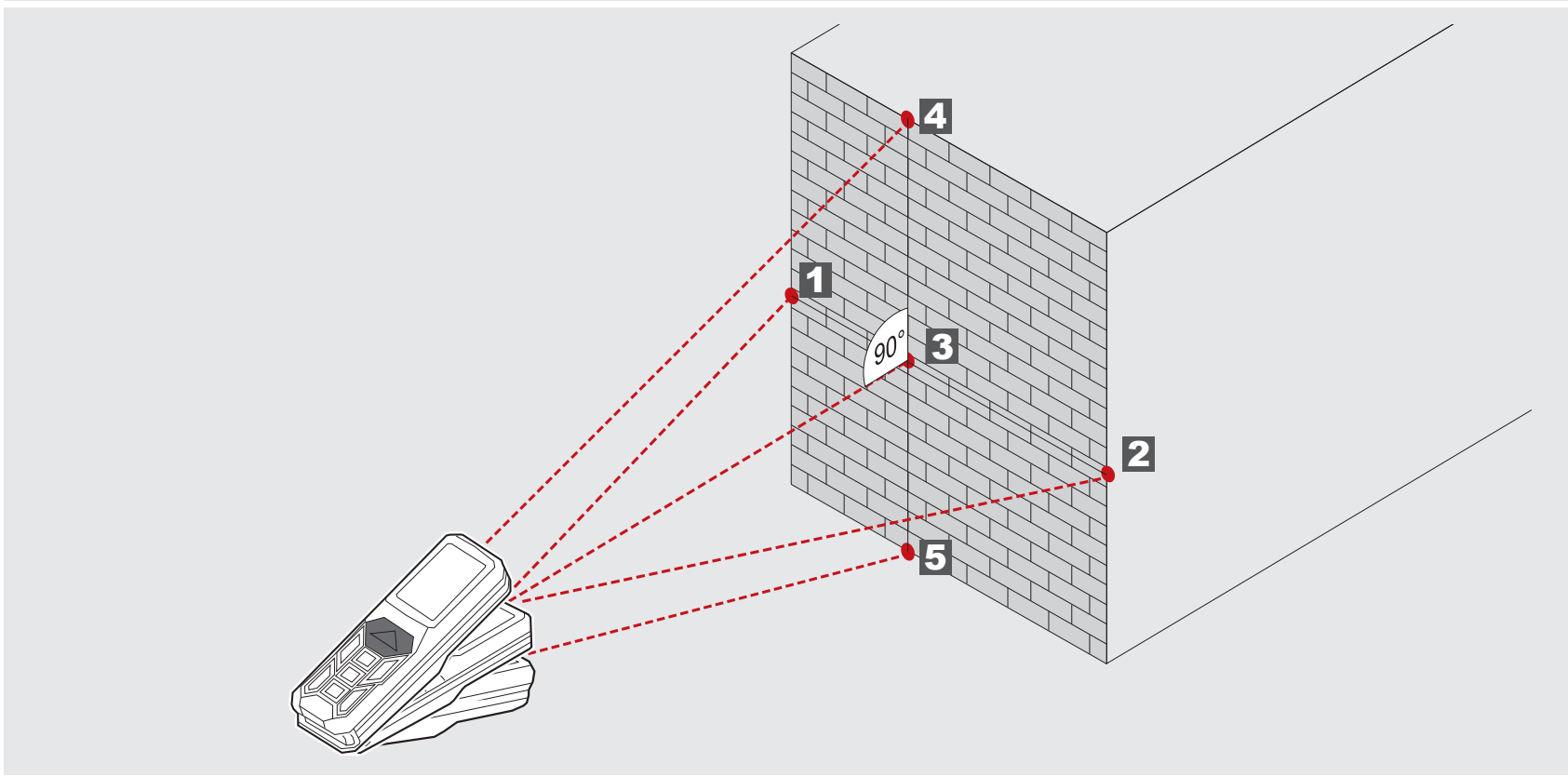
MEDICIÓN DE SUPERFICIES DE PAREDES (ESCENARIO 1)

0 	1 	2 	3 	4 
				

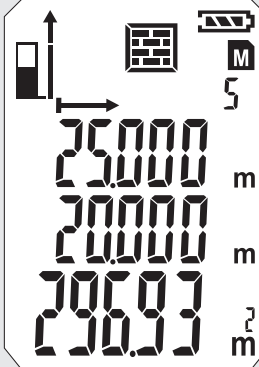

5 

MEDICIÓN DE SUPERFICIES DE PAREDES (ESCENARIO 2)

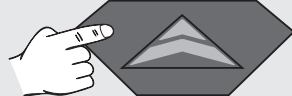
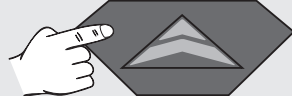
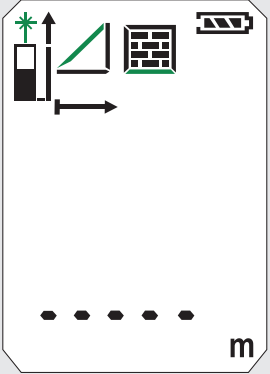
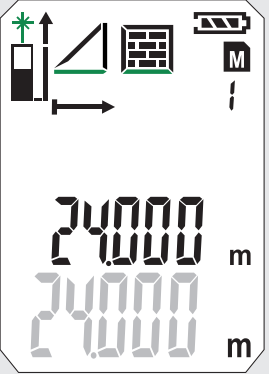
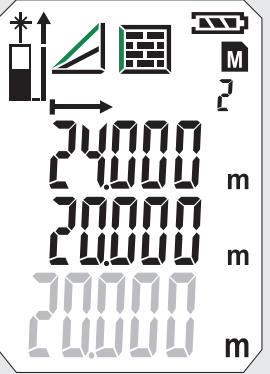
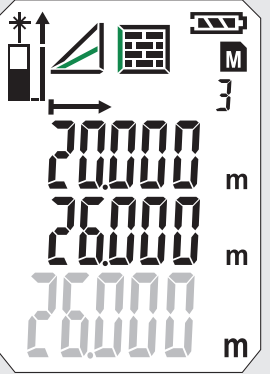
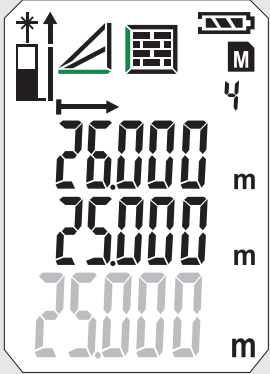
0 	1 	2 	3 	4 
				

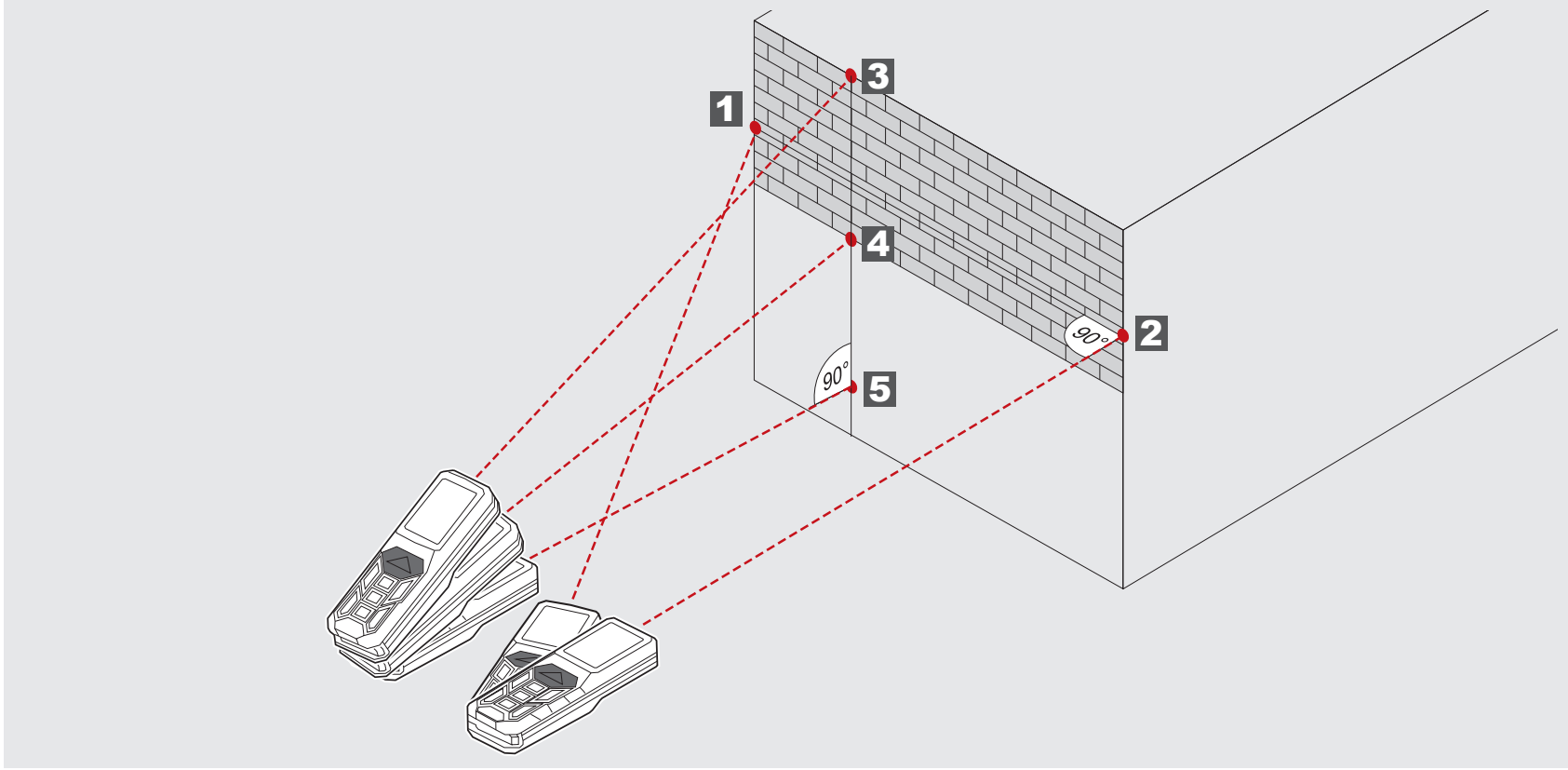

5



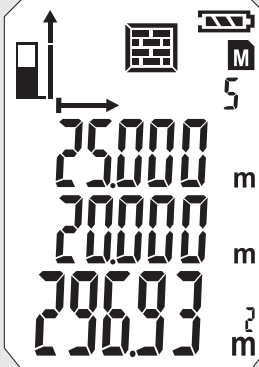



TEMPORIZADOR

Mediante el temporizador se puede activar la medición de forma retardada, por ej. para posicionar un componente en el haz de medición.

Pulsar la tecla 

- Aparece el símbolo.
- Pulsando la tecla  el temporizador se puede ajustar entre 3 y 15 segundos.

Pulsar la tecla 

- Los segundos se van descontando hasta efectuar la medición.
- Al llegar a 0 se activa la medición.

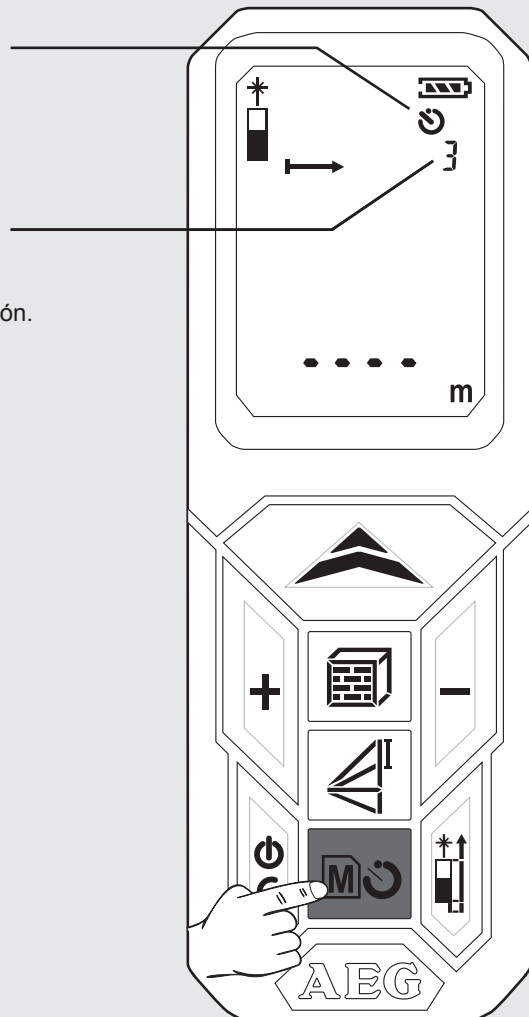

MEMORIA

Los valores de medición se van guardando automáticamente y de manera progresiva en la memoria.

Los valores guardados se pueden visualizar con la tecla .

Pulsar la tecla  2 segundos.

- Aparece el símbolo y la posición de memoria.
- Se visualiza la magnitud de medición correspondiente.
- El valor guardado se visualiza en la línea principal.
- Navegar con las teclas +/-

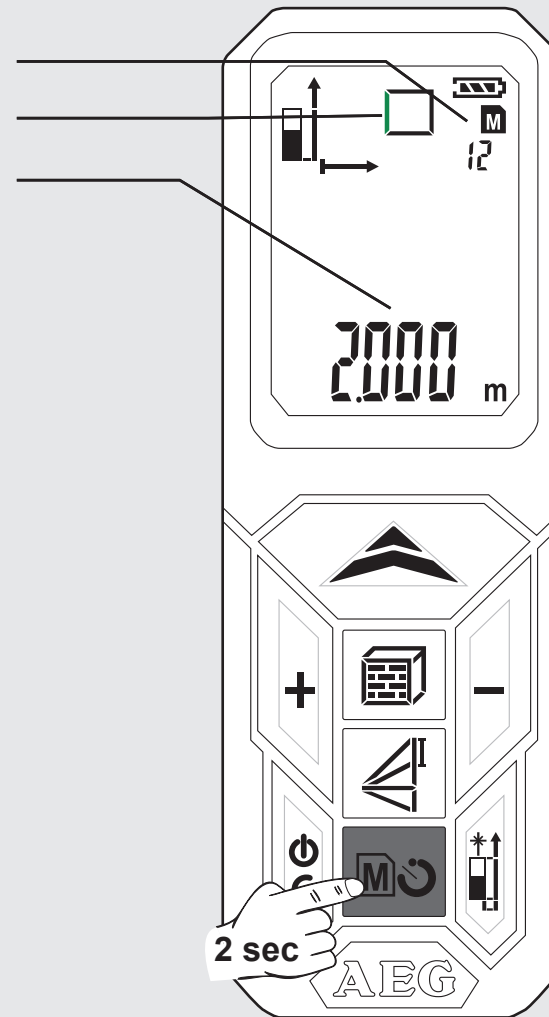



FUNCIONAMIENTO BÁSICO PONIENDO COMO EJEMPLO UNA MEDICIÓN DE SUPERFICIES (1)

1 Encender

Pulsar la tecla .
⚠ ¡Atención! ¡El rayo láser está encendido!
 ¡No dirigir hacia personas!

El símbolo del láser parpadea (parpadea en color verde).

2 Seleccionar el plano de medición

Ajuste estándar después de la activación: atrás
 Pulsar 1 vez -> punta de ángulos
 Pulsar 2 veces -> delante
 Pulsar 3 veces -> atrás

El símbolo se visualiza.

3 Seleccionar la función

Después de la activación, el aparato se encuentra posicionado siempre en medición de longitud.
 Pulsar 1 vez  -> medición de superficies

- El símbolo aparece.
 - La magnitud de medición parpadea (parpadea en color verde)

4 Medir la longitud

Orientar el aparato y pulsar la tecla 

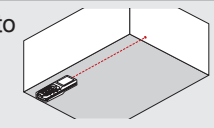

- El valor medido aparece brevemente en la línea principal.
 - Después de haber transcurrido 1 segundo, el valor medido salta a la línea situada directamente encima.
 El valor medido se guarda en la memoria con el número consecutivo.
 La segunda magnitud de medición parpadea. El aparato está listo para la medición del segundo valor.

5 Medir la anchura

Orientar el aparato y pulsar la tecla 

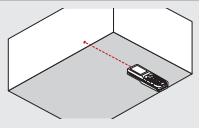

- El valor medido aparece brevemente en la línea principal.
 - Después de haber transcurrido 1 segundo, el valor medido salta a la línea situada directamente encima.
 - El valor medido se guarda en la memoria con el número consecutivo.
 - El resultado se visualiza en la línea principal y se guarda en la memoria con el número consecutivo.

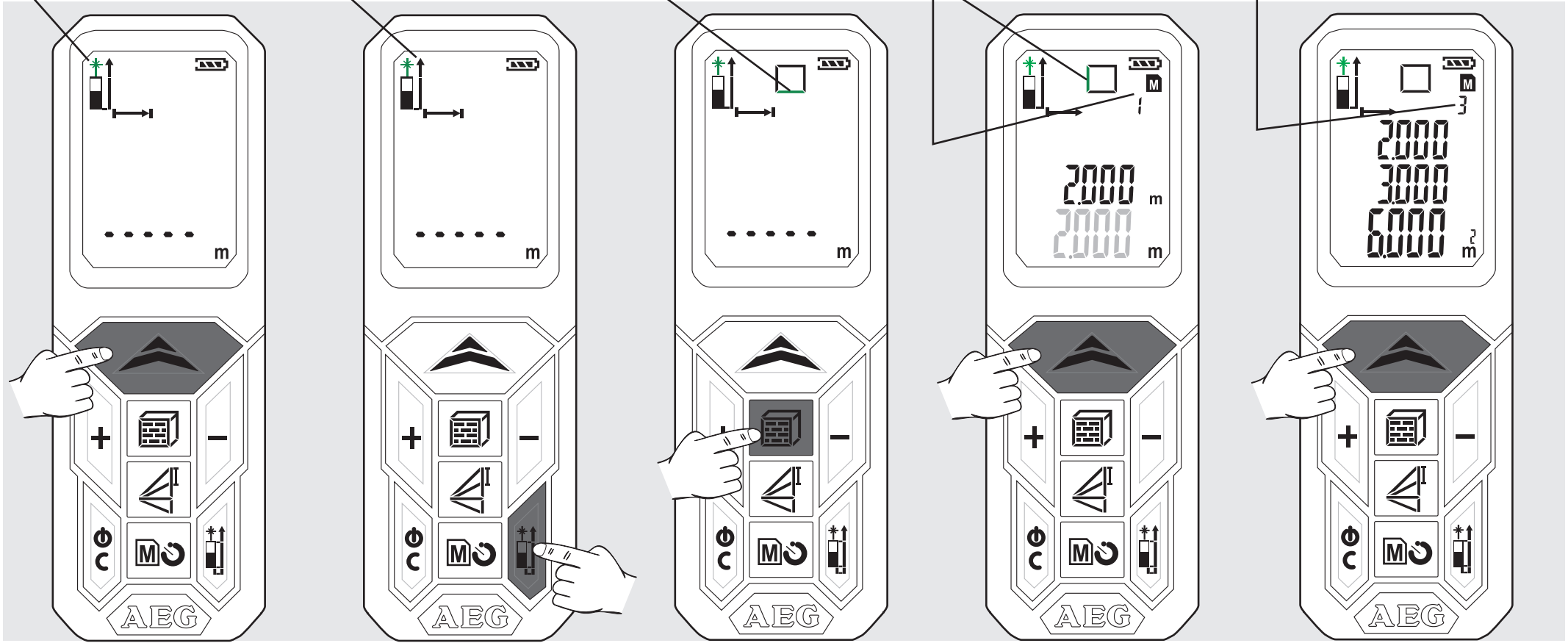

FUNCIONAMIENTO BÁSICO PONIENDO COMO EJEMPLO UNA MEDICIÓN DE SUPERFICIES (2)

6 Visualizar los valores guardados

Pulsar la tecla  2 segundos.
Pulsar la tecla + o -

7 Abandonar la memoria

Pulsar la tecla 

8 Apagar

Pulsar la tecla  durante 2 segundos
(Antes se debe abandonar la memoria).

- Los valores guardados se visualizan en la línea principal.
- El símbolo correspondiente aparece y la magnitud de medición parpadea (parpadea en color verde).

- El aparato se apaga.
- Si durante un lapso de tiempo de 3 minutos no se presiona ninguna tecla, el aparato se apaga automáticamente.

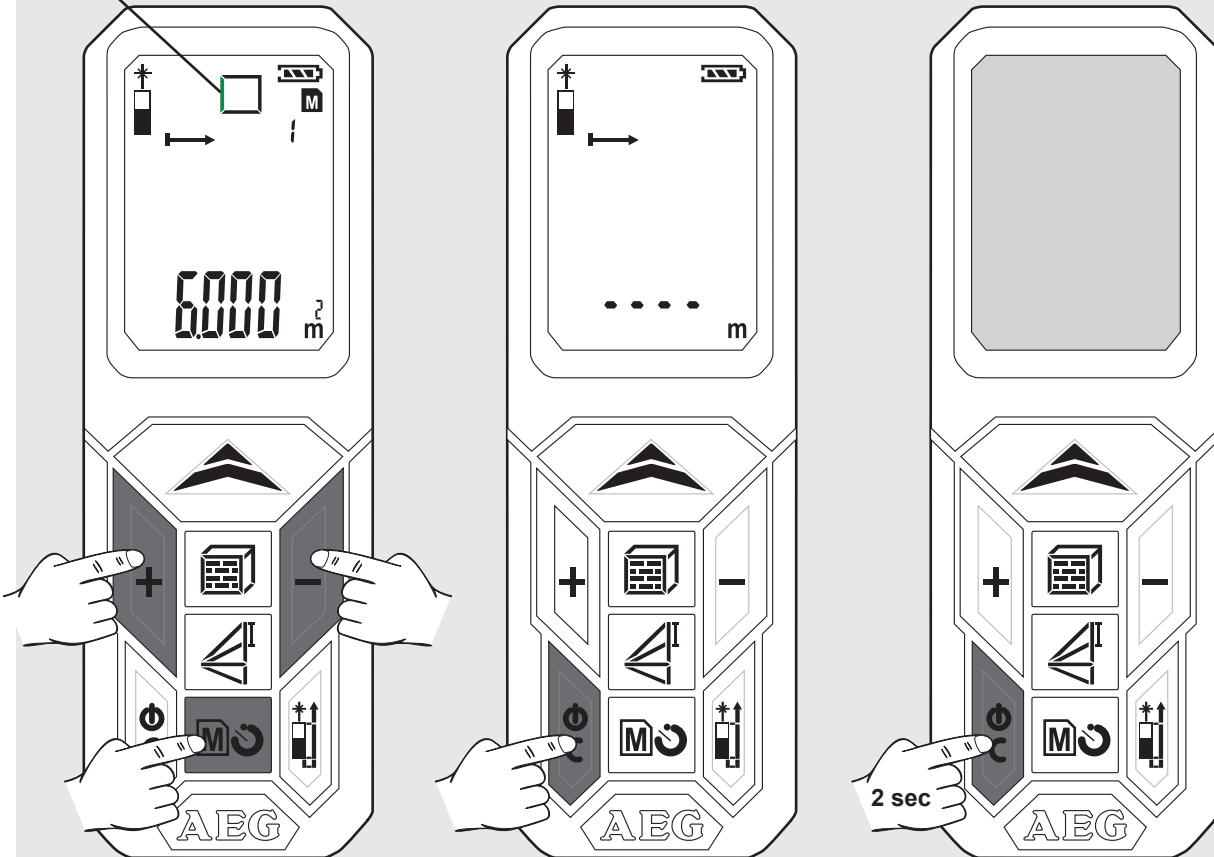

CONTEÚDO

Instruções de Segurança Importantes.....1
 Características técnicas2
 Utilização autorizada2
 Tabela de códigos de erro2
 Vista geral.....3
 Trocar a bateria4
 Pino de canto.....4
 Clip de cinto.....4
 Tecla de função, pitágoras, referência de medição5
 Medição de comprimento simples6
 Medição contínua / Medição mínimo-máximo7
 Medição de adição / subtração.....8
 Medição da área.....9
 Medição do volume10
 Medição indirecta (pitágoras 1)11
 Medição indirecta (pitágoras 2)12
 Medição indirecta (pitágoras 3)13
 Medição da área da parede (cenário 1)14
 Medição da área da parede (cenário 2)15
 Temporizador.....16
 Memória.....16
 Modo de funcionamento básico no exemplo de uma medição da área (1)17
 Modo de funcionamento básico no exemplo de uma medição da área (2)18

INSTRUÇÕES DE SEGURANÇA IMPORTANTES

 Não utilizar o produto, antes de ler atentamente as Instruções de Segurança e o Manual de Operação incluídos no CD-ROM fornecido com o produto.

Classificação do laser

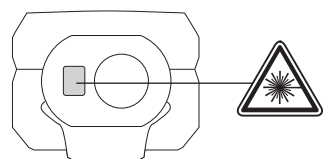

ATENÇÃO:
 Produto laser de Classe 2, de acordo com a Norma IEC 60825-1:2007.



Etiquetagem

Por favor, cole o autocolante na sua língua nacional juntado sobre o texto em inglês na placa das características do equipamento antes da primeira colocação em serviço.

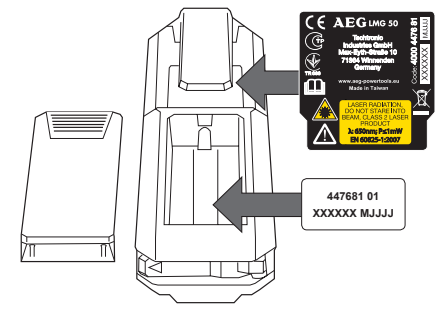

Aviso:
 Não olhar directamente para o feixe de luz laser. O raio laser pode queimar os olhos e levar a uma cegueira temporária.

Não olhar directamente para o feixe de luz laser, nem apontar o feixe de luz directamente para as outras pessoas.

Não apontar o feixe de luz laser para outras pessoas.

Aviso:
 Não opere o aparelho de laser na proximidade de crianças e não deixe crianças usar o aparelho de laser.

Atenção! Uma superfície reflectora pode reflectar o raio laser ao operador ou a terceiros.

Manter as extremidades a uma distância segura das peças móveis.

Efectuar medições de teste frequentes. Especialmente, antes, durante ou depois de medições importantes.

Em caso de anomalia no funcionamento, queda ou utilização incorrecta do produto, ou se este tiver sido modificado, existe o risco de as medições efectuadas serem incorrectas.

Atenção! Familiarize-se com os elementos de comando e com a utilização do aparelho de jardinagem.

O medidor a laser tem uma área de utilização limitada. (Veja a secção "Dados técnicos"). Tentativas de medir fora da área máxima e mínima levam medições inexactas. A utilização em caso de condições adversas, como muito quente, muito frio, luz do sol muito clara, chuva, neve, névoa ou outras condições que prejudiquem a vista pode levar a medições inexactas.

Se o medidor a laser for levado de um ambiente quente a um ambiente frio (ou vice-versa), aguarde até o aparelho se adaptar à temperatura ambiente nova.

Guarde o medidor a laser no interior, proteja o aparelho contra choque, vibrações ou temperaturas extremas.

Proteja o medidor a laser contra pó, humidade e alta humidade do ar. Isto poderia destruir componentes internos ou influenciar a precisão.

Não use detergentes ou solventes agressivos. Só limpe com um pano limpo e macio.

Evite choques duros ou a queda do medidor a laser. A precisão do aparelho deve ser verificada depois dele cair ou ter sido exposto a outros esforços mecânicos.

Reparações necessárias neste aparelho de laser só devem ser executadas pelo pessoal especializado e autorizado.

Não utilizar o produto em áreas com risco de explosão ou ambientes agressivos.

Para carregar as baterias, utilizar apenas carregadores recomendados pelo fabricante.

 As pilhas esgotadas não devem ser descartadas juntamente com os resíduos domésticos. Proteger o ambiente e descartar as pilhas nos pontos de recolha ("Pilhões") da sua área de residência. O instrumento não

deve ser descartado juntamente com os resíduos domésticos.

Eliminar o instrumento de acordo com os regulamentos aplicáveis em vigor. Respeitar os regulamentos nacionais específicos do país. Contacte a sua autoridade local ou o seu vendedor para informações relativas à eliminação.



CARACTERÍSTICAS TÉCNICAS

Classe de protecção	IP54 (protegido contra pó e salpicos de água)
Lente	14 mm
Foco	35 mm
Área de medição máx.	50 metros (tolerância: 55m)
Área de medição mín.	0,05 metros
Precisão absoluta @ < 10m	± 1,5 mm (máx.)
Precisão de repetição @ < 10m	± 1,5 mm (típica máx. 2σ)
Precisão de repetição @ > 10m	aumento ± 0,25 mm / metros (típica máx. 2σ)
Tempo de medição	0,5 s
Tela tipo	LCD (22,7 mm x 31 mm)
Alimentação eléctrica	AAA 2x (bateria alcalina)
Vida útil da bateria	10000 (medição individual)
Potência de saída do laser	0,6 mW ~ 0,95 mW (classe 2, 650nm)
Tamanho do ponto do laser	25 x 30 mm @ 16 m (máx.)
Raio laser ângulo vertical	+1 grau
Raio laser ângulo horizontal	±1 grau
Desligamento automático do aparelho	180 segundos
Desligamento automático do laser	30 segundos
Gama de temperatura de trabalho	-10°C a +50°C
Gama de temperatura de armazenamento	-25°C a +70°C
Peso sem bateria	80 g

UTILIZAÇÃO AUTORIZADA

O medidor a laser destina-se a medir distâncias e inclinações.

Não use este produto de outra maneira sem ser a normal para o qual foi concebido.

TABELA DE CÓDIGOS DE ERRO

Código	Descrição	Solução
Err01	Fora da área de medição	Faça a medição na área prevista.
Err02	Sinal reflectido muito fraco	Selecione uma superfície melhor.
Err03	Fora da gama de indicação (valor máx.: 99.999) p. ex. é o resultado de área ou volume fora da gama de indicação	Verifique, se os valores ou passos são correctos.
Err04	Erro no cálculo de pitágoras#tsab#Verifique, se os valores e passos são corretos.	Check and verify values and steps are correct
Err05	Bateria a esgotar	Coloque baterias novas.
Err06	Fora da gama de temperatura de serviço	Faça a medição na gama de temperatura prevista.
Err07	Luz ambiente muito clara	Escureça a área de destino.

Pitágoras
Diferença de altura

Referência de medição

Medição do comprimento

Mínimo / Máximo para a medição contínua

Adição / Subtracção

LIGAR / MEDIR

- ▶ Ligar
- ▶ Medir
- ▶ Medição contínua (pressionar por 2 seg.)
Função mín. / máx.

ADIÇÃO

- ▶ Adicionar o valor
- ▶ Navegar na memória

ÁREA / VOLUME

- ▶ Área (pressionar 1x)
- ▶ Volume (pressionar 2x)
- ▶ Medição indirecta da área (pressionar 3x / 4x)

LIGAR

- ▶ Ligar
- ▶ Desligar (pressionar por 2 seg)
- ▶ Resetar

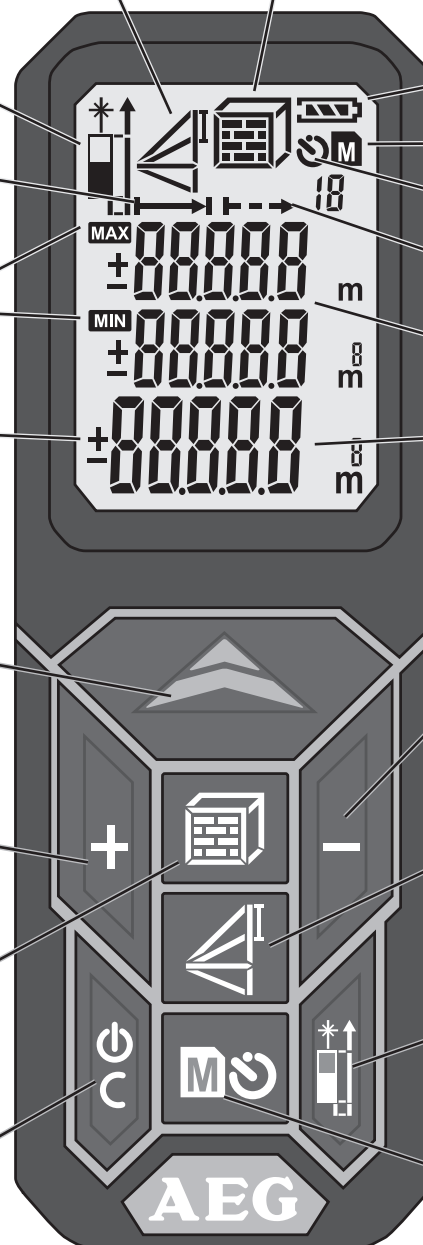

Área / Volume
Medição indirecta da área

Status da bateria

Memória

Temporizador

Medição contínua

Valores intermediários

Total

SUBTRACÇÃO

- ▶ Subtrair o valor
- ▶ Navegar na memória

PITÁGORAS

- ▶ Pitágoras 1 (pressionar 1x)
- ▶ Pitágoras 2 (pressionar 2x)
- ▶ Pitágoras 3 (pressionar 3x)

MUDAR A REFERÊNCIA DE MEDIÇÃO

- ▶ Frente
- ▶ Atrás
- ▶ Pino de canto

MEMÓRIA

- ▶ Temporizador 3-15 seg (pressionar 1x)
- ▶ Memória 1-20 (pressionar 1x por 2 seg)
- ▶ Navegar na memória com as teclas +/-

TROCAR A BATERIA

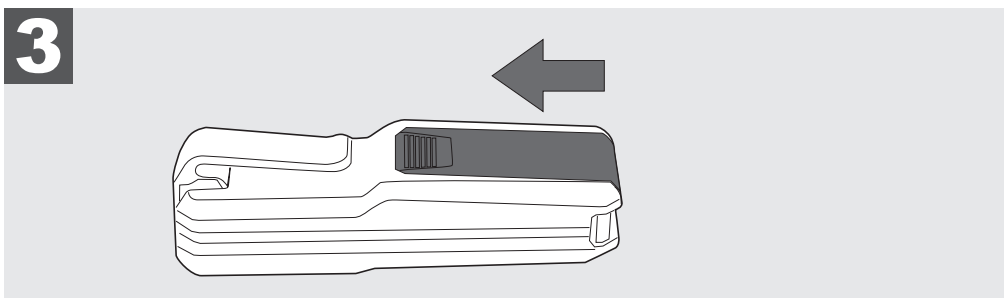
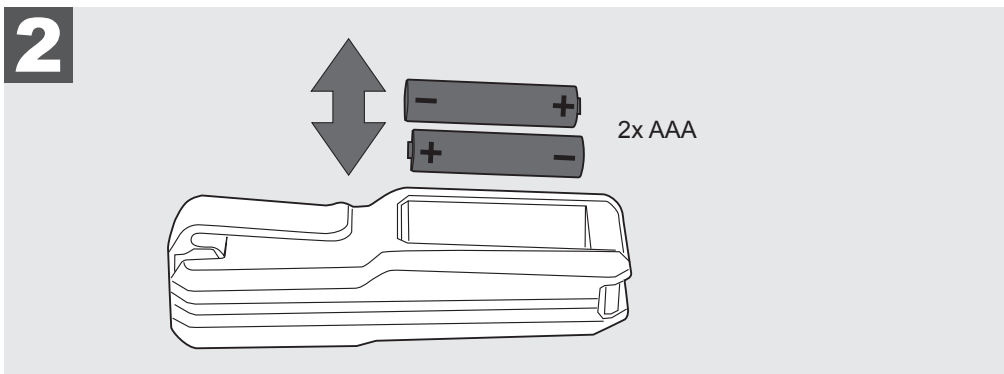
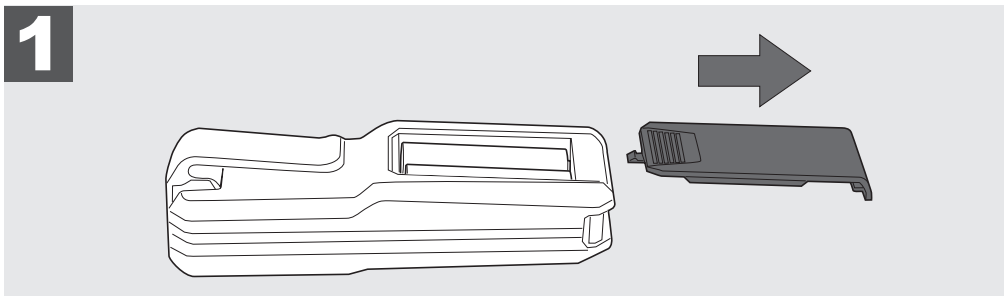
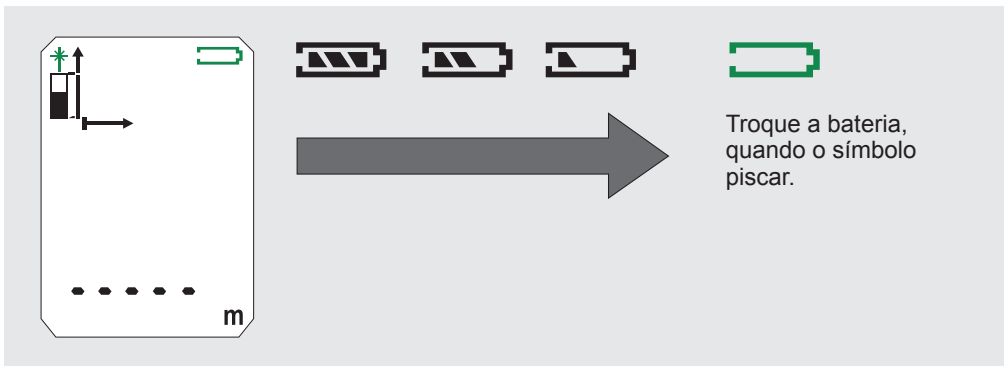

PINO DE CANTO

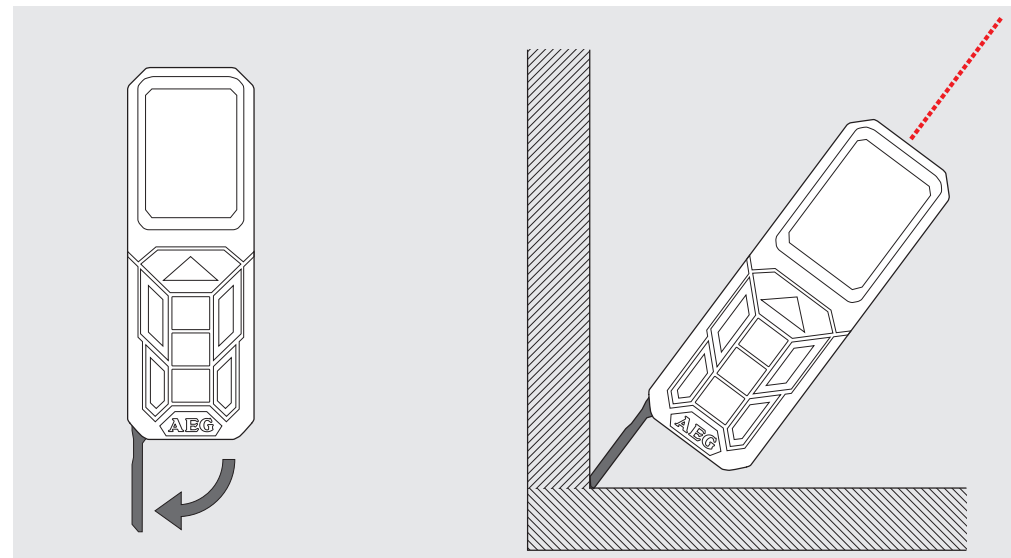

CLIP DE CINTO

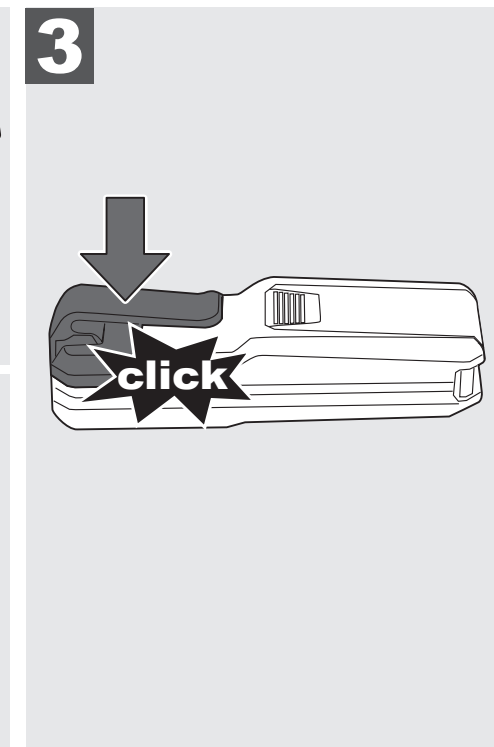
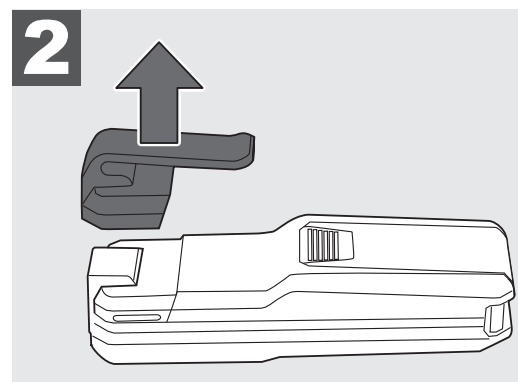
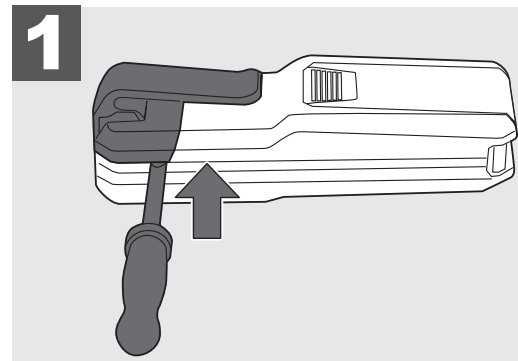

TECLA DE FUNÇÃO, PITÁGORAS, REFERÊNCIA DE MEDIÇÃO

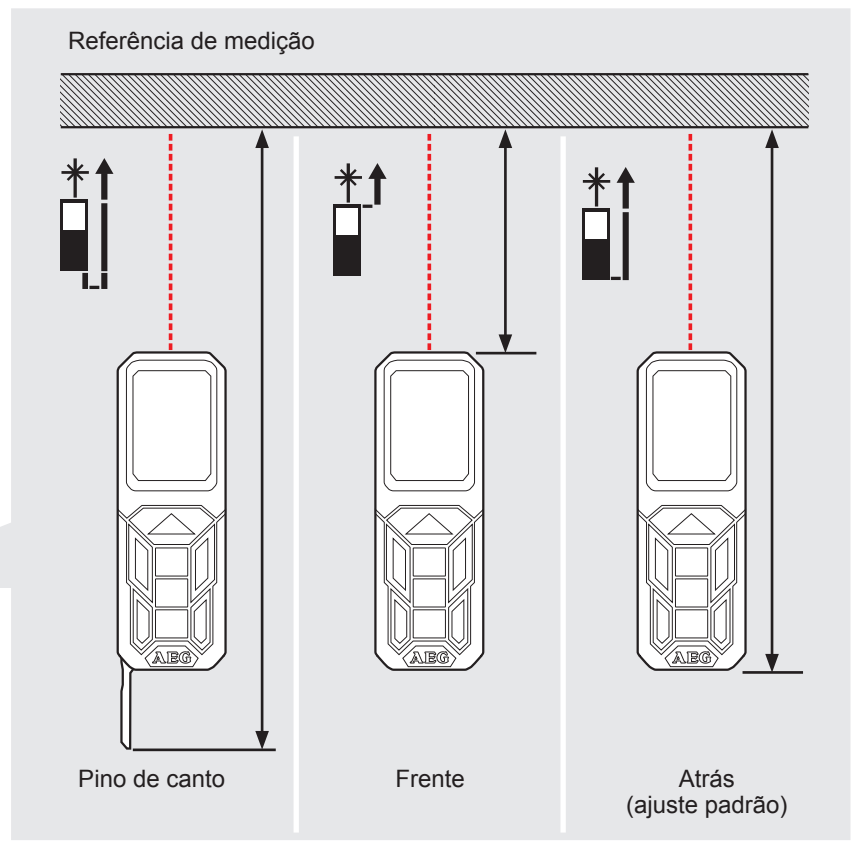
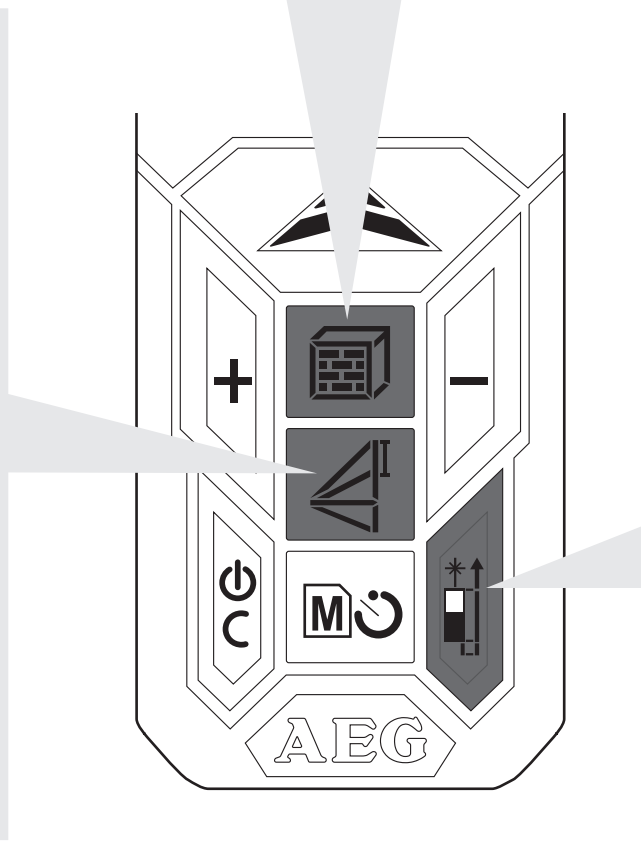
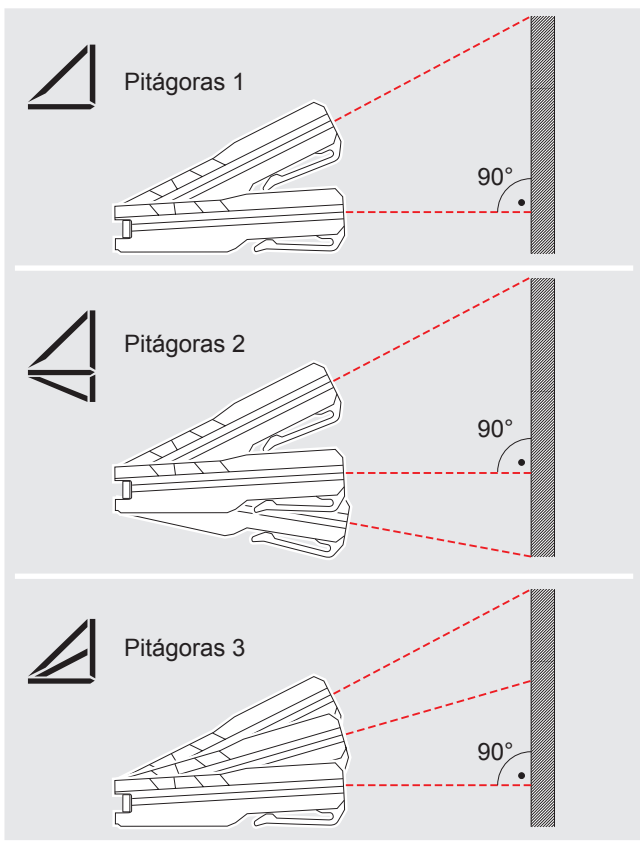
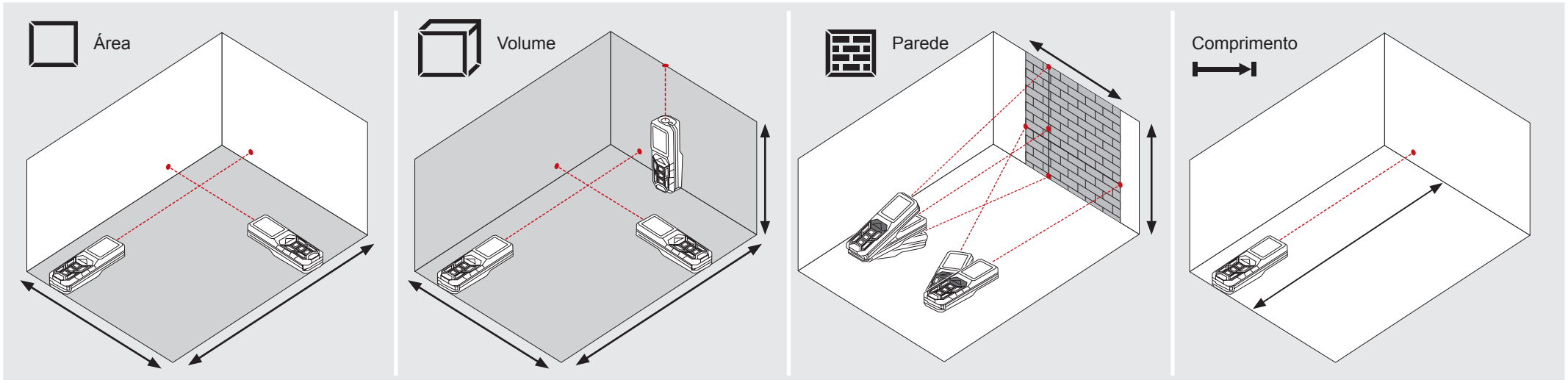

MEDIÇÃO DE COMPRIMENTO SIMPLES

0

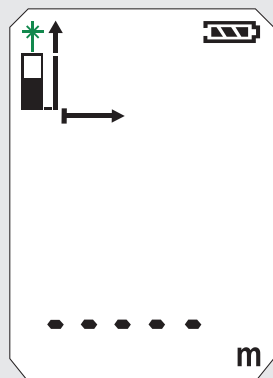

1

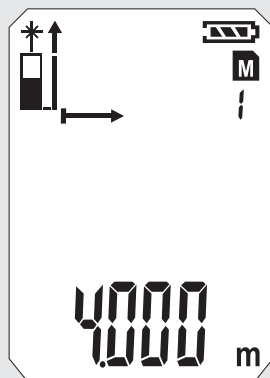
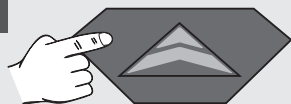

2

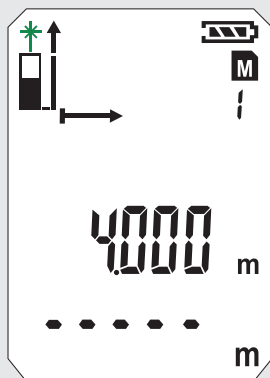
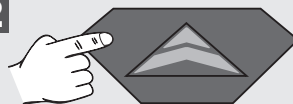

3

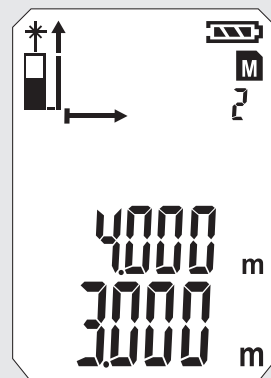
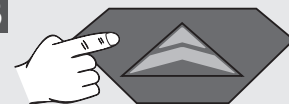

4

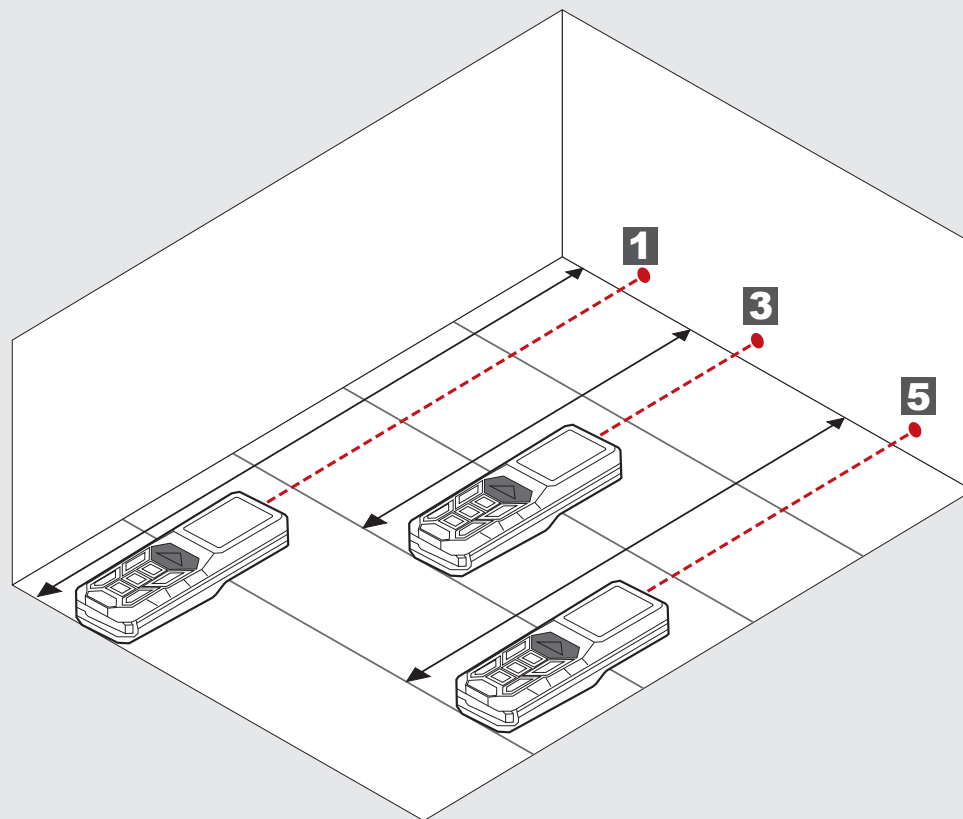
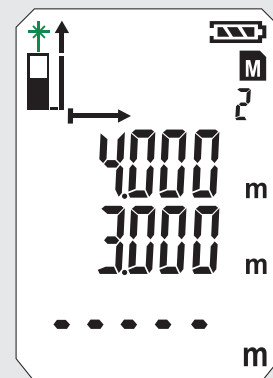
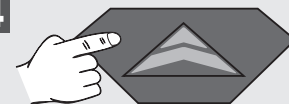

5

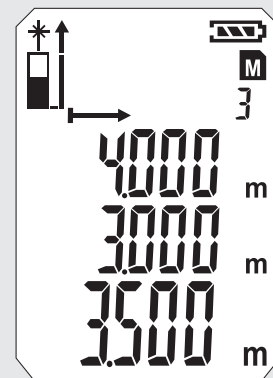
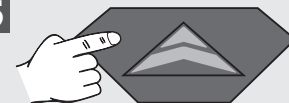

MEDIÇÃO CONTÍNUA / MEDIÇÃO MÍNIMO-MÁXIMO

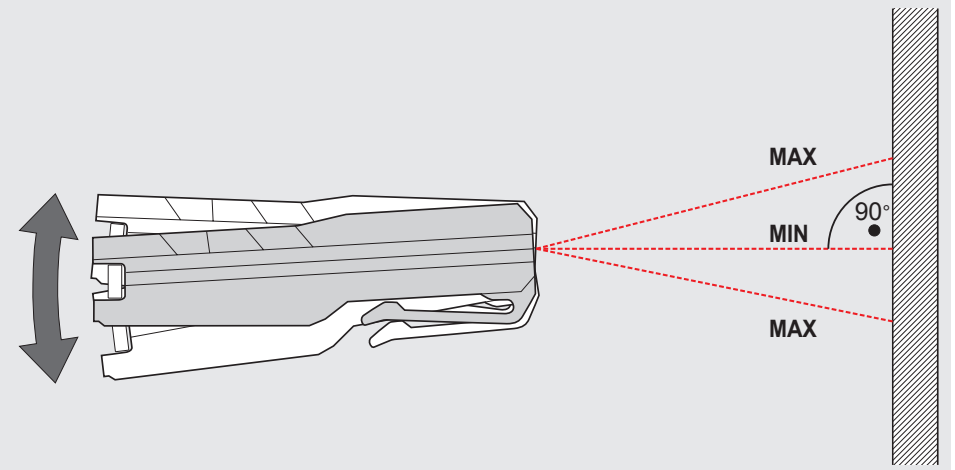
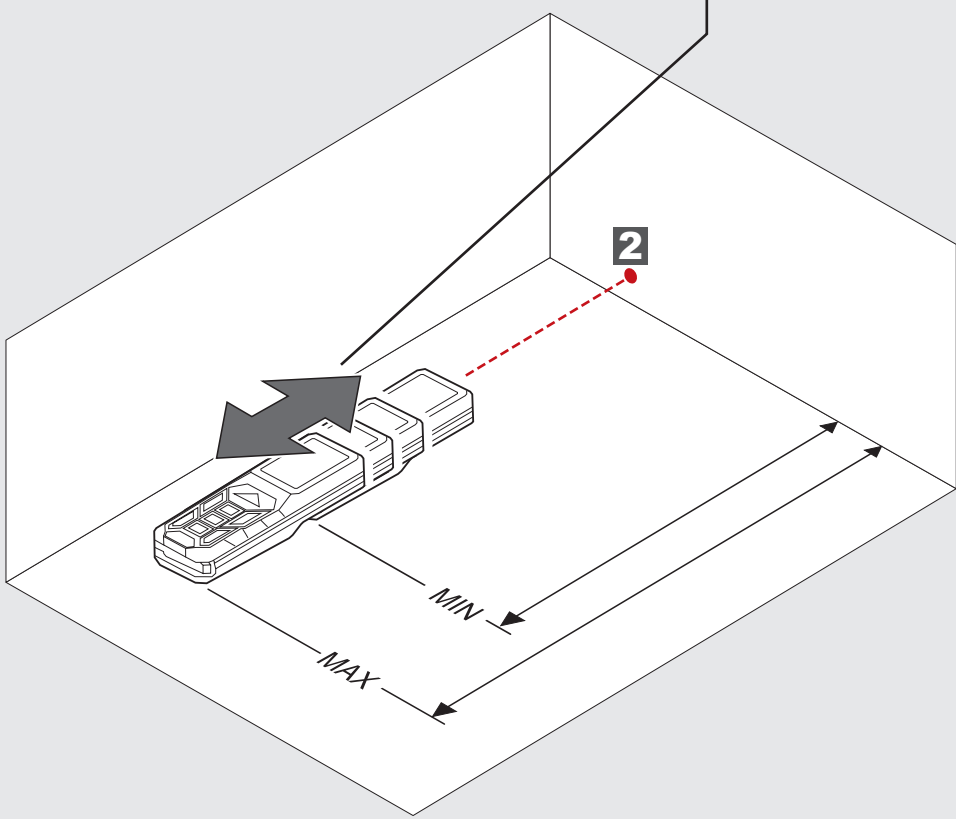
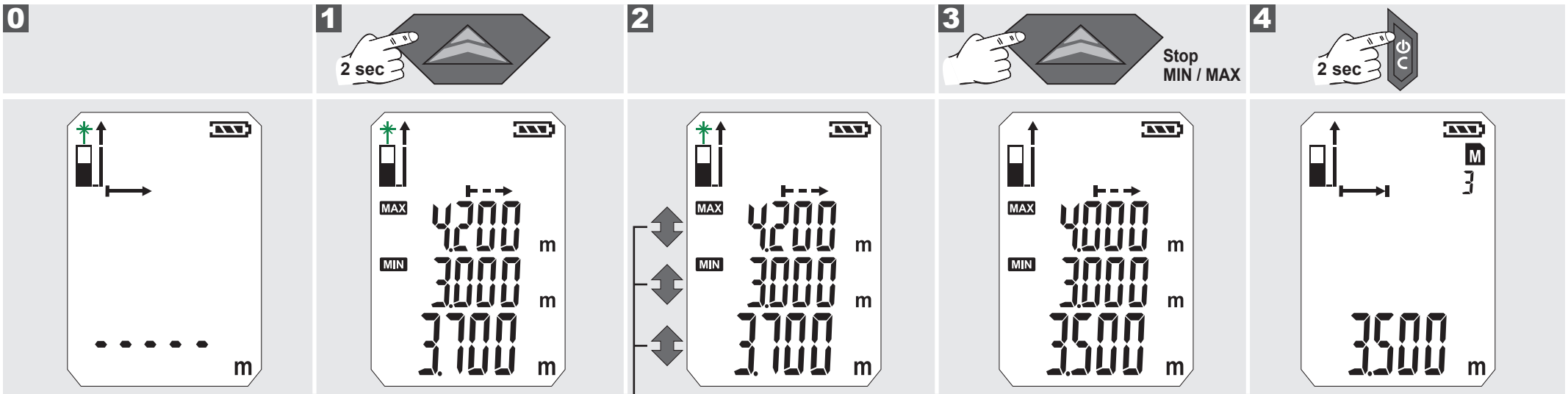

0

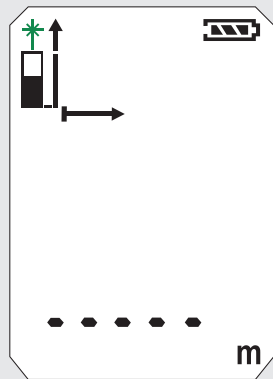

1

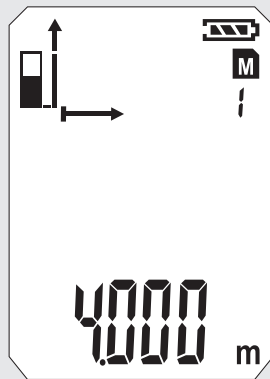
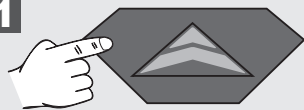

2

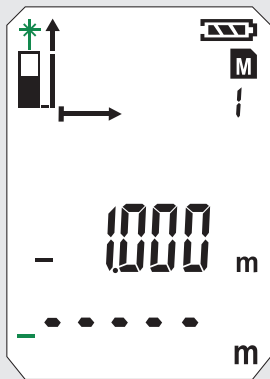

3

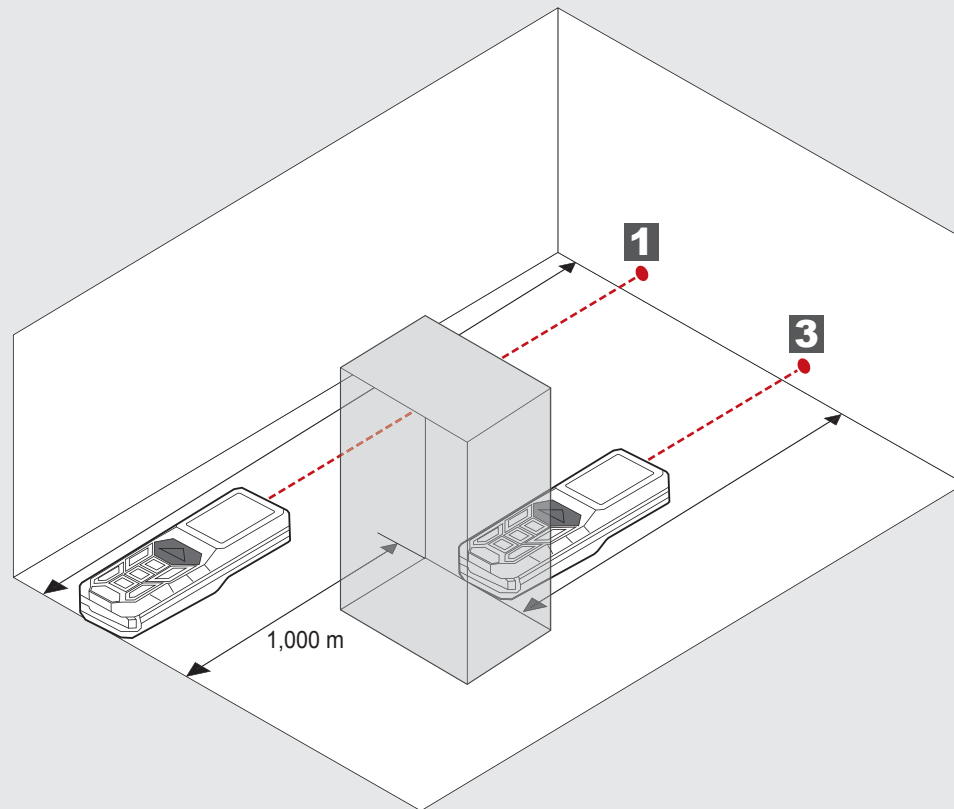
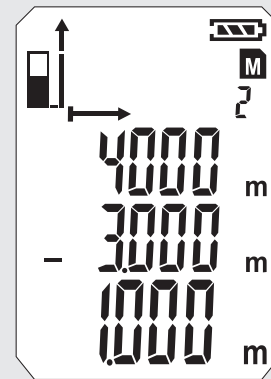
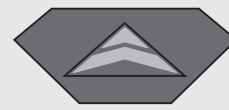

MEDIÇÃO DA ÁREA

0



1

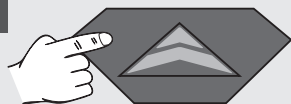

2

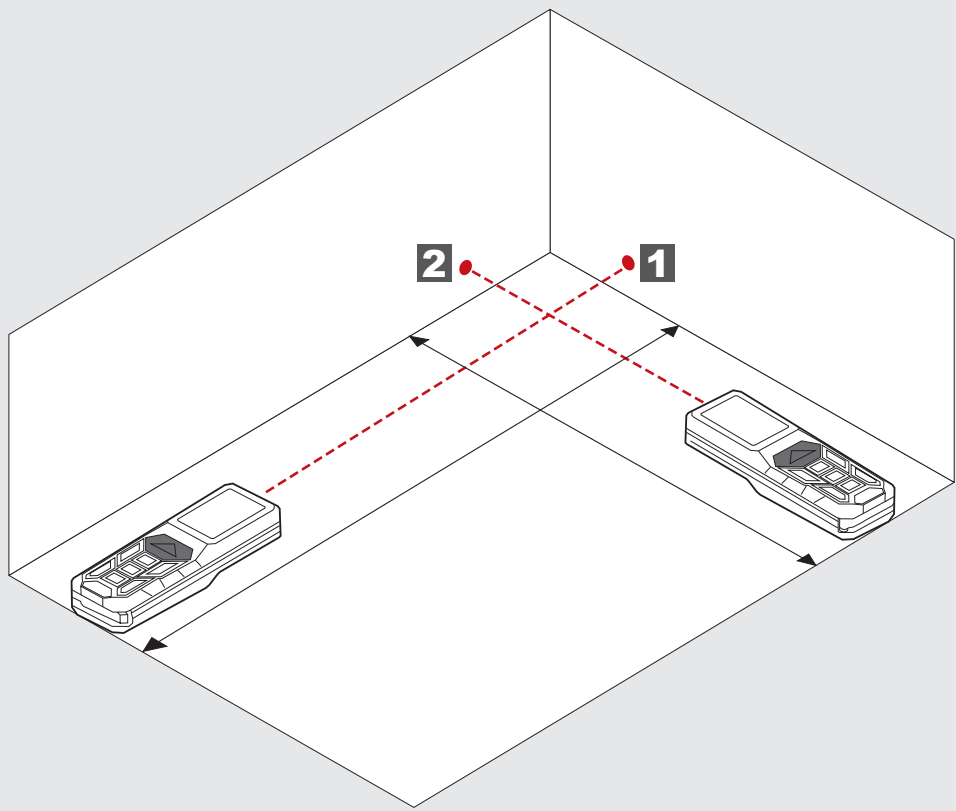
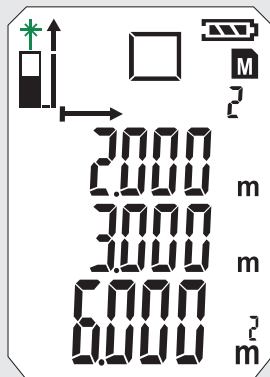
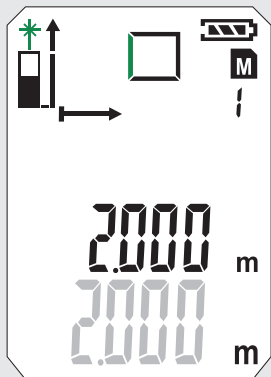
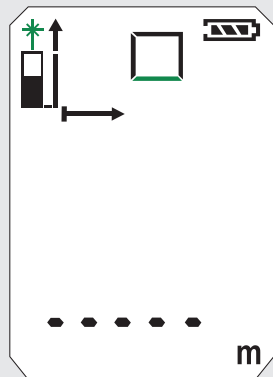
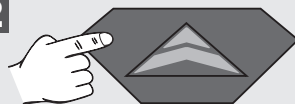

MEDIÇÃO DO VOLUME

0

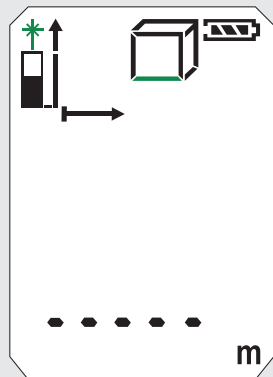

1

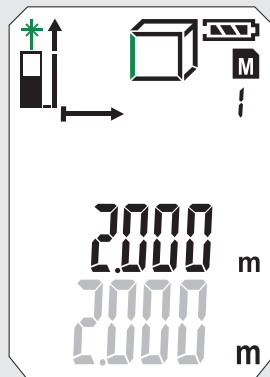
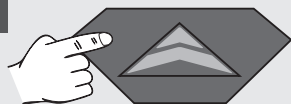

2

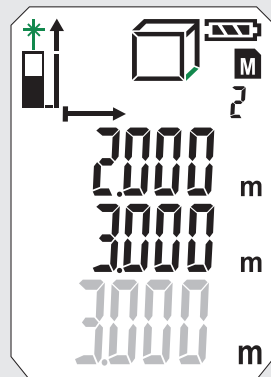
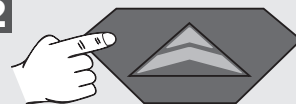

3

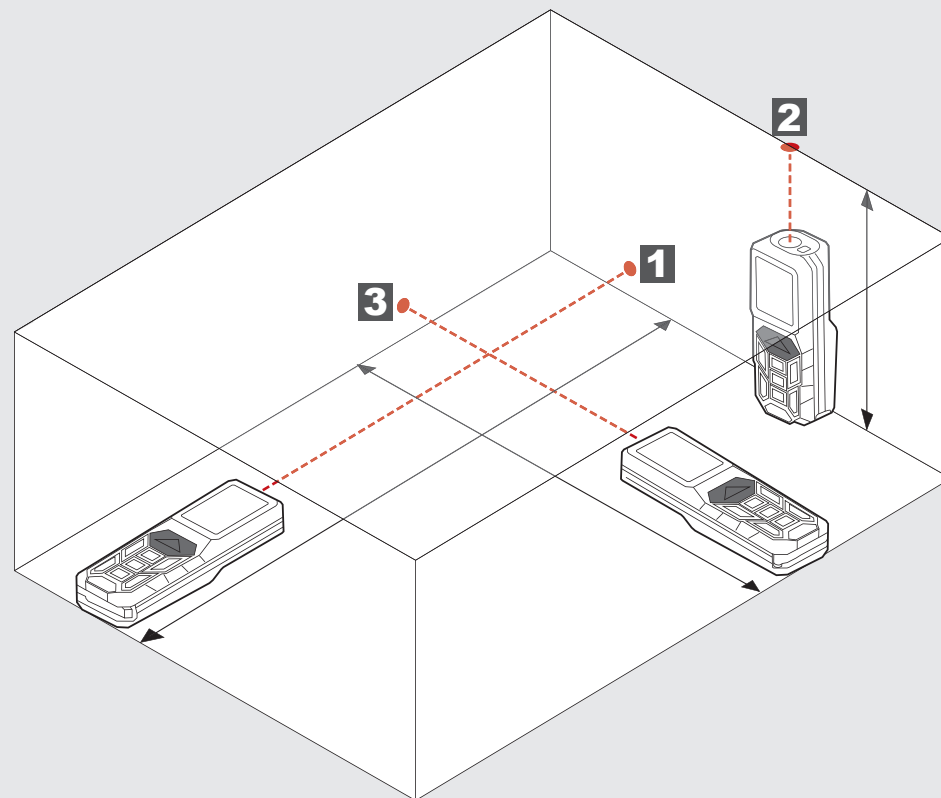
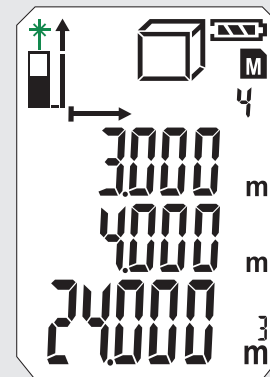
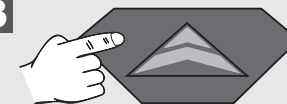

MEDIÇÃO INDIRECTA (PITÁGORAS 1)

0



1

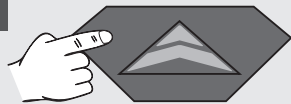

2

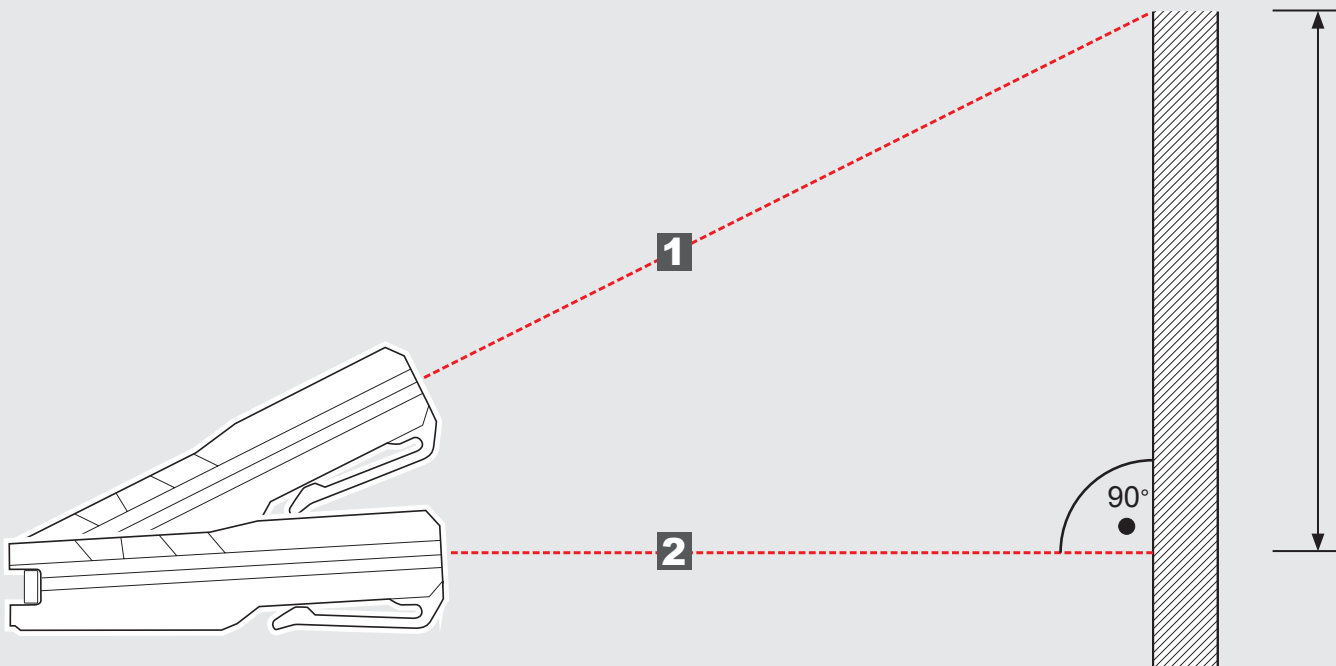
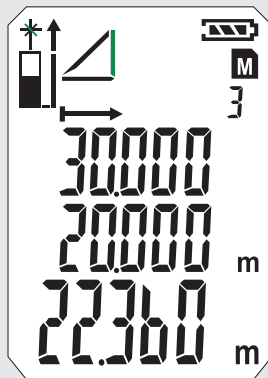
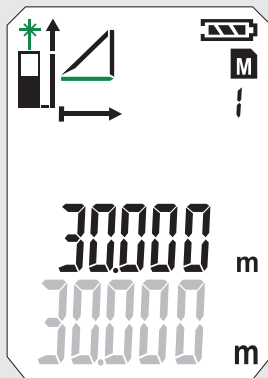
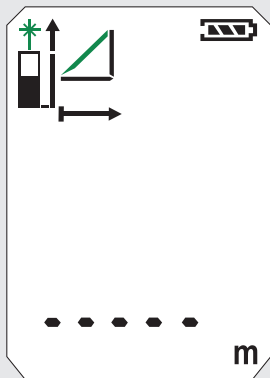
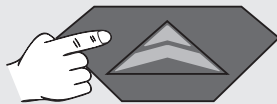

MEDIÇÃO INDIRECTA (PITÁGORAS 2)

0



1

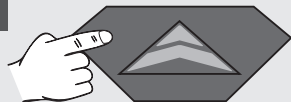

2



3

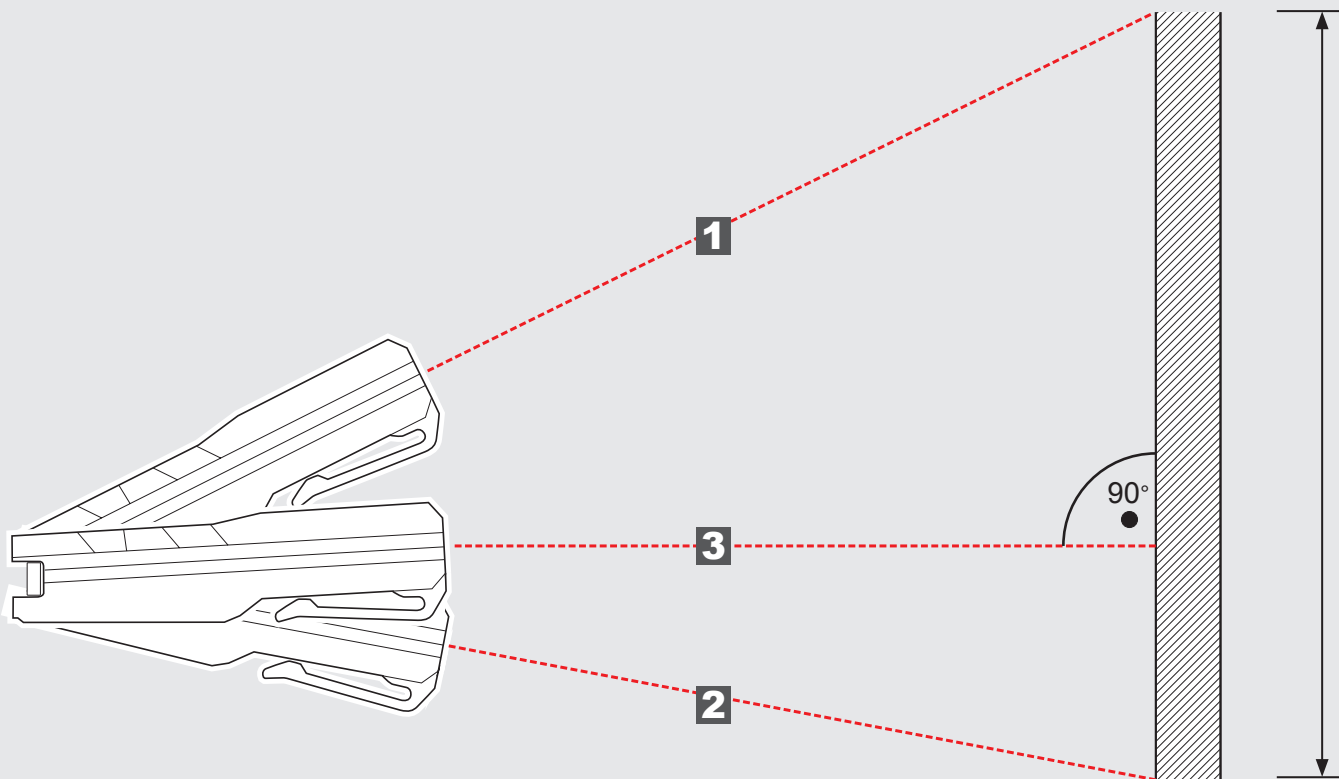
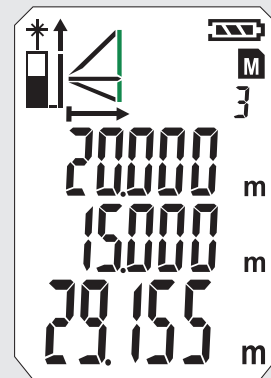
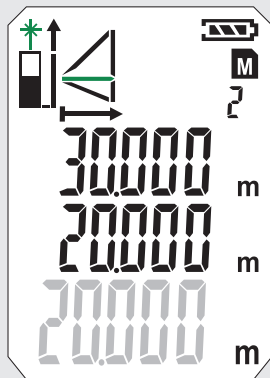
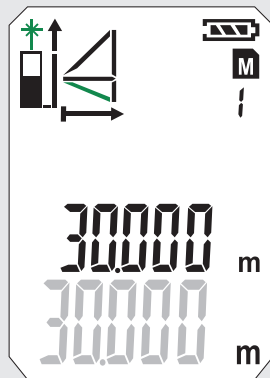
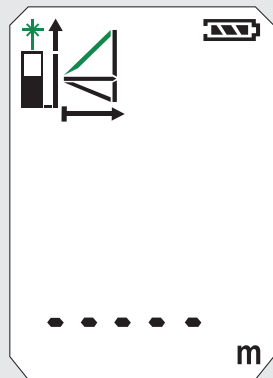

MEDIÇÃO INDIRECTA (PITÁGORAS 3)

1



2

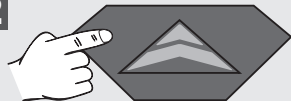



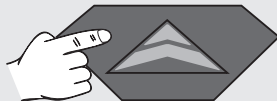

3

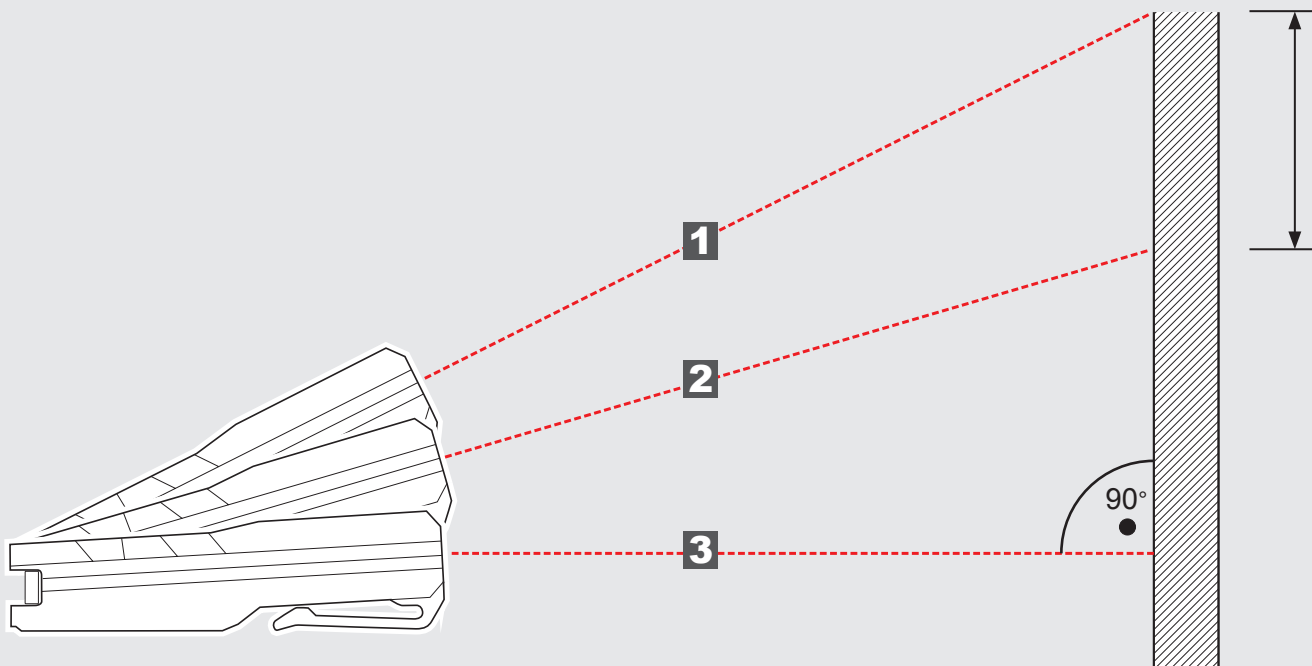
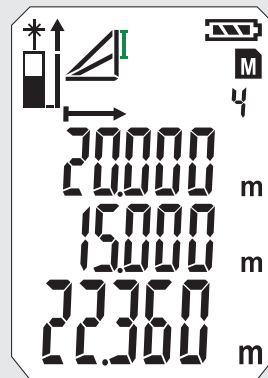
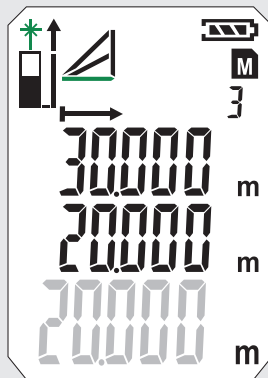
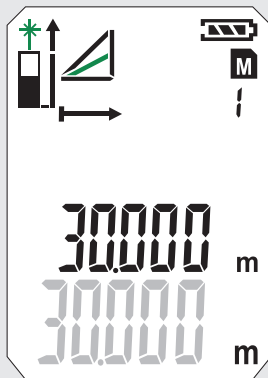
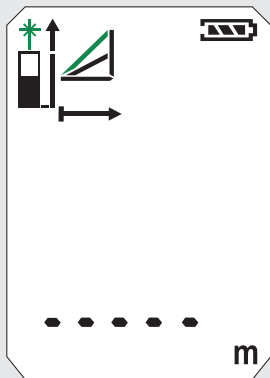

4

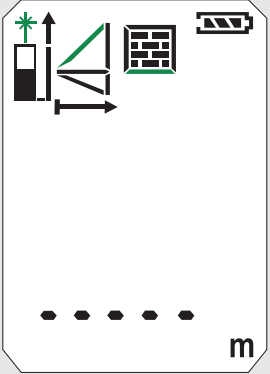
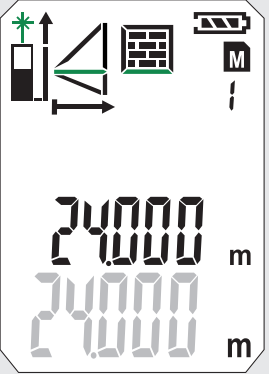
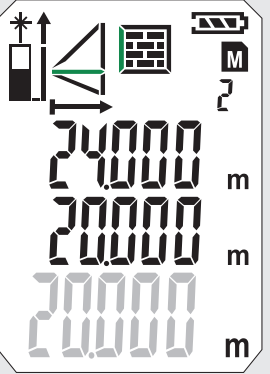
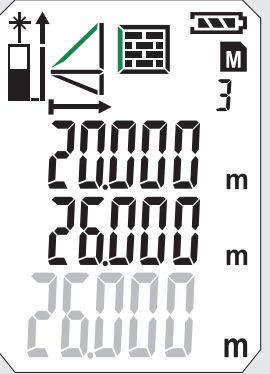
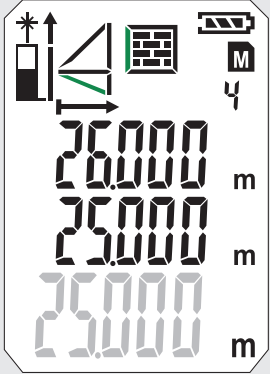

MEDIÇÃO DA ÁREA DA PAREDE (CENÁRIO 1)

<p>0</p> 	<p>1</p> 	<p>2</p> 	<p>3</p> 	<p>4</p> 
				

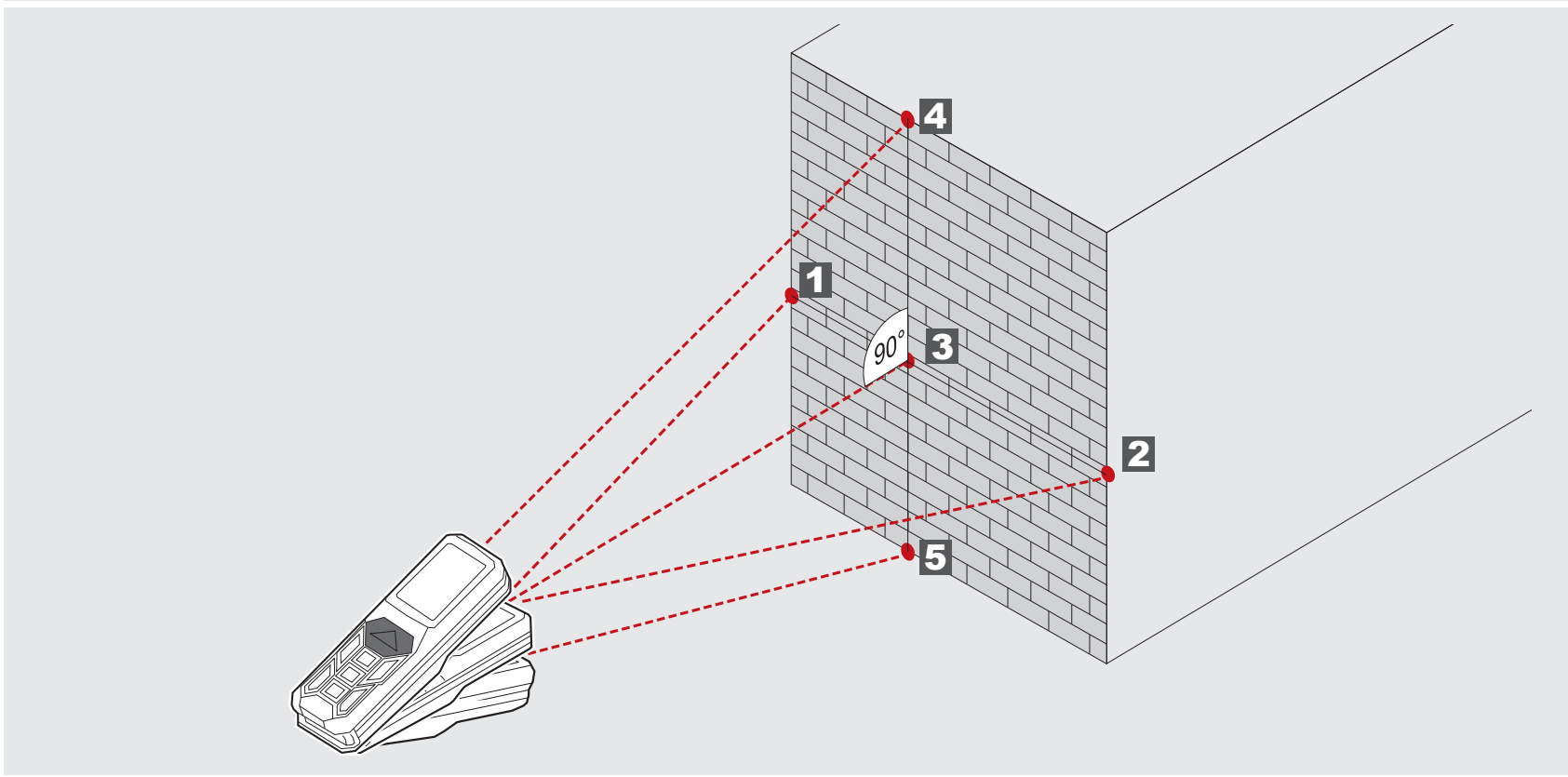





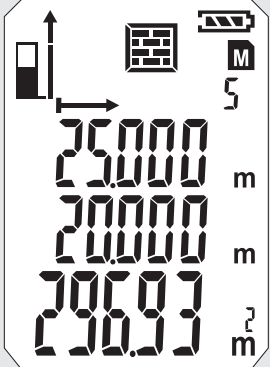









5



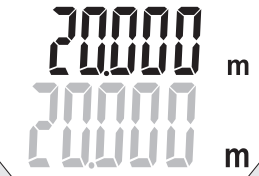

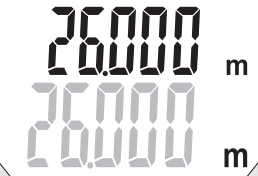
MEDIÇÃO DA ÁREA DA PAREDE (CENÁRIO 2)

0 	1 	2 	3 	4 
 	 	 	 	 

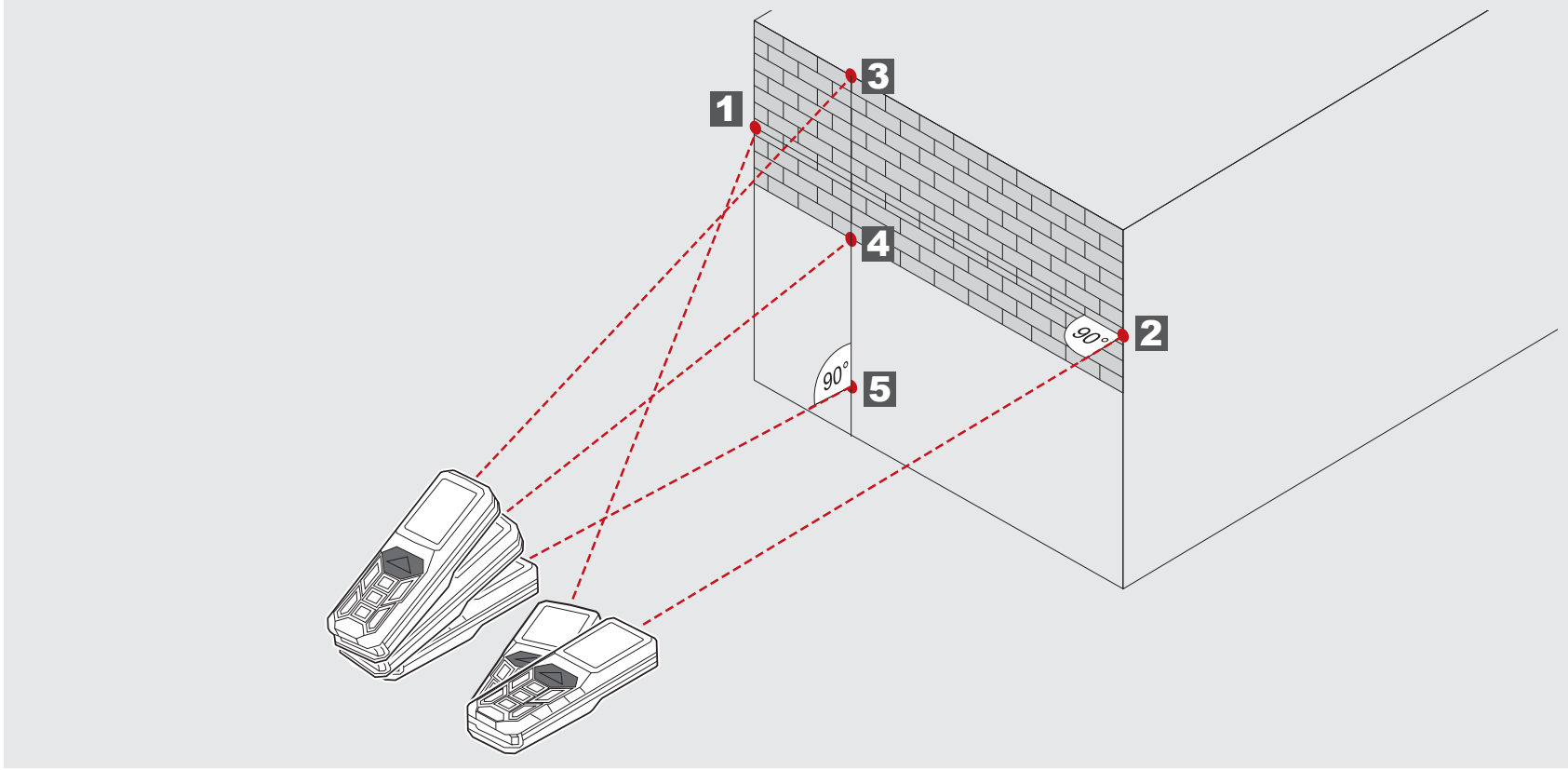

5



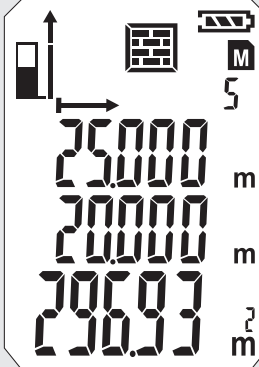



TEMPORIZADOR

Com o temporizador a medição pode ser activada com retardo, p. ex. para posicionar um componente no raio de medição.

Pressione a tecla 

- O símbolo aparece
Pressionando a tecla  o temporizador pode ser ajustado entre 3 e 15 seg

Pressione a tecla 

- São contados os segundos até à medição.
- Ao chegar a 0, a medição é activada.

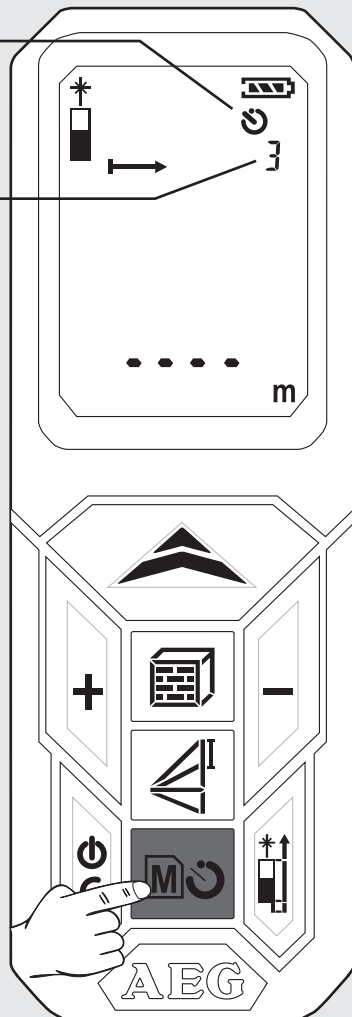

MEMÓRIA

Os valores de medição são memorizados automaticamente e sucessivamente na memória.

Os valores memorizados podem ser acessados com a tecla .

Pressione a tecla  por 2 seg

- O símbolo e o espaço de memória aparecem.
- Os parâmetros de medição correspondentes são indicados.
- O valor memorizado é mostrado na linha principal.
- Navegue com as teclas +/-.

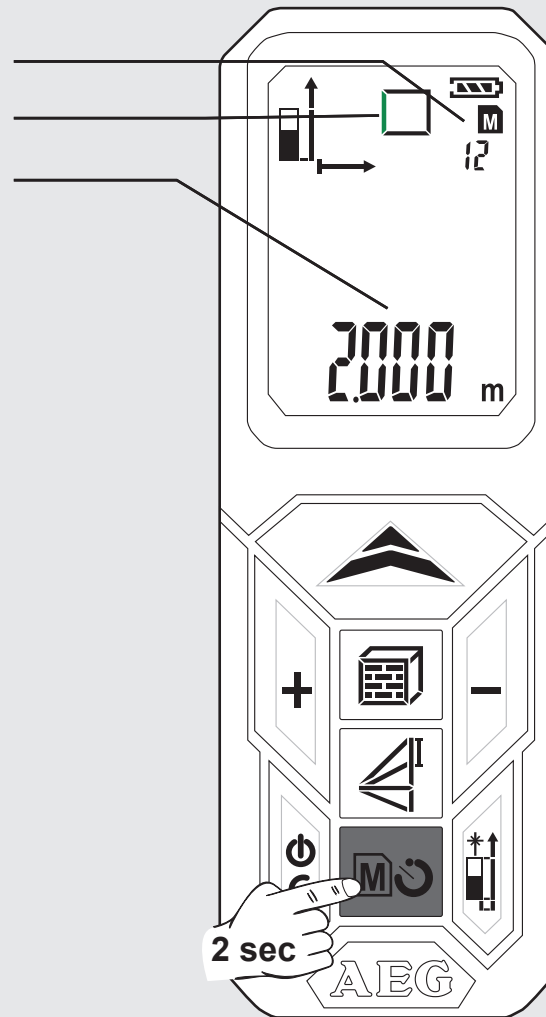

MODO DE FUNCIONAMENTO BÁSICO NO EXEMPLO DE UMA MEDIÇÃO DA ÁREA (1)

1 Ligar



Pressione a tecla .

⚠ Atenção! Raio laser ligado!
Não apontar contra pessoas!

O símbolo do laser pisca (o piscar verde é mostrado).

2 Seleccione a referência de medição

Ajuste padrão depois de ligar: atrás

-  Pressione 1x -> pino de canto
-  Pressione 2x -> frente
-  Pressione 3x -> atrás

O símbolo é mostrado

3 Seleccione a função

Depois de ligar, o aparelho sempre está ajustado em medição do comprimento.

-  Pressione 1x - Medição da área

- O símbolo aparece
- O parâmetro de medição pisca (o piscar é mostrado em verde)

4 Medir o comprimento

Alinhe o aparelho e pressione a tecla .

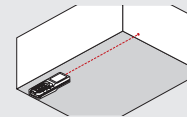

- O valor de medição aparece brevemente na linha principal.
- Após 1 seg o valor de medição salta para a linha superior.
- O valor de medição é memorizado na memória sob o número corrido.
- O segundo parâmetro de medição pisca. O aparelho está pronto para medir o segundo valor.

5 Medir a largura

Alinhe o aparelho e pressione a tecla .

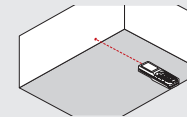

- O valor de medição aparece brevemente na linha principal.
- Após 1 seg o valor de medição salta para a linha superior.
- O valor de medição é memorizado na memória sob o número corrido.
- O resultado é mostrado na linha principal e é memorizado na memória sob o número corrido.

MODO DE FUNCIONAMENTO BÁSICO NO EXEMPLO DE UMA MEDIÇÃO DA ÁREA (2)

6 Ver os valores memorizados

Pressione a tecla  por 2 seg.
Pressione a tecla + ou -

7 Sair da memória

Pressione a tecla 

8 Desligar

Pressione a tecla  por 2 seg
(primeiro, deverá ser saído da memória).

- Os valores memorizados são mostrados na linha principal.

- O símbolo correspondente é mostrado e o parâmetro de medição pisca (p piscar é mostrado em verde).

- O aparelho desliga-se.

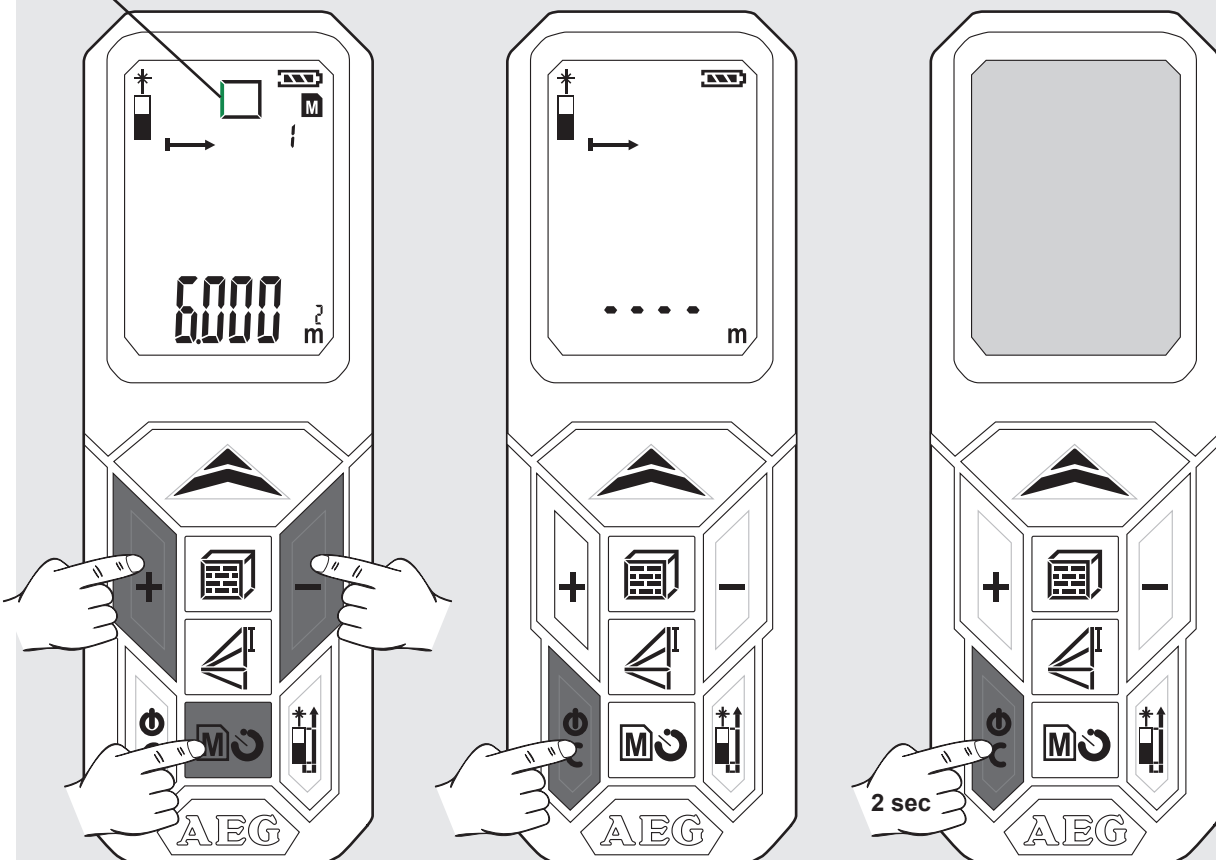

- Se nenhuma tecla for pressionada por 3 minutos, o aparelho desligar-se-á automaticamente.



INHOUD

Belangrijke Veiligheidsvoorschriften1
 Technische gegevens2
 Voorgeschreven gebruik van het systeem.....2
 Tabel met storingscodes2
 Overzicht3
 Vervangen van de batterijen.....4
 Hoekpen4
 Riemhouder4
 Functietoets, Pythagoras, meetniveau5
 Eenvoudige lengtemeting6
 Constante meting / minimum-/maximum-meting7
 Optel-/aftrekmeting8
 Oppervlaktemeting9
 Volumemeting10
 Indirecte meting (Pythagoras 1)11
 Indirecte meting (Pythagoras 2)12
 Indirecte meting (Pythagoras 3)13
 Wandoppervlaktemeting (scenario 1).....14
 Wandoppervlaktemeting (scenario 2).....15
 Timer16
 Geheugen16
 Principiële werking aan de hand van een oppervlaktemeting (1).....17
 Principiële werking aan de hand van een oppervlaktemeting (2).....18

BELANGRIJKE VEILIGHEIDSVoORSCHRIFTEN

  Gebruik dit product niet voordat u de veiligheidsinstructies en de gebruiksaanwijzing op de bijgevoegde CD hebt bestudeerd.

Laserclassificatie

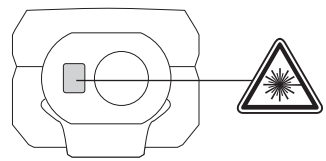

WAARSCHUWING:
 Het is een Klasse 2 laserproduct in overeenstemming met IEC 60825-1:2007.



Opschrift

Plak de Engelse tekst op het vermogensplaatje vóór de eerste inbedrijfstelling af met de bijgeleverde sticker in uw taal.

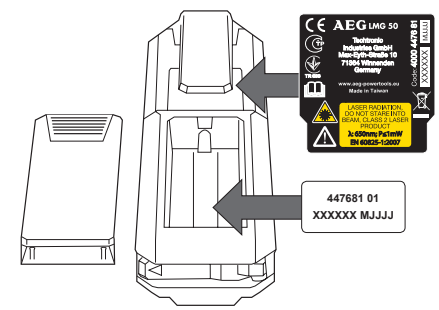

Waarschuwing!

Vermijd direct blikcontact. Het felle licht van de laserstraal kan tot letsel aan de ogen leiden en de ogen kortstondig verblinden.

Kijk niet in de laserstraal en richt niet onnodig op andere personen.

Andere personen niet verblinden.

Waarschuwing!

Het laserapparaat mag noch in de buurt van kinderen worden gebruikt noch mogen kinderen het apparaat gebruiken.

Opgelet! Een reflecterend oppervlak zou de laserstraal terug naar de bediener of een andere persoon kunnen reflecteren.

Houd een veilige afstand aan naar bewegende delen.

Verricht periodiek controlemetingen. Met name vlak voor, tijdens en na belangrijke metingen.

Pas op voor meetfouten als het instrument defect is of als het is gevallen, misbruikt of gemodificeerd.

Let op! Maak uzelf vertrouwd met de bedieningselementen en het juiste gebruik van het tuingereedschap.

Het lasermeettoestel heeft een beperkt toepassingsbereik. (Zie hoofdstuk 'Technische gegevens'). Pogingen om buiten het maximale en minimale bereik te meten resulteren in onnauwkeurige resultaten. De toepassing onder ongunstige omstandigheden, zoals te grote hitte of koude, fel zonlicht, regen, sneeuw, mist of andere, het zicht belemmerende omstandigheden kan leiden tot onnauwkeurige meetresultaten.

Als het lasermeettoestel van een warme naar een koude omgeving wordt gebracht (of omgekeerd), moet u even wachten totdat het toestel zich aan de nieuwe omgevingstemperatuur heeft kunnen aanpassen.

Bewaar het lasermeettoestel altijd in gesloten ruimten en bescherm het tegen schokken, vibraties of extreme temperaturen.

Bescherm het lasermeettoestel tegen stof, natheid en te hoge luchtvochtigheid. Deze factoren zouden inwendige onderdelen onherstelbaar kunnen beschadigen of de nauwkeurigheid negatief kunnen beïnvloeden.

Gebruik geen agressieve reinigingsmiddelen of oplosmiddelen. Reinig het toestel uitsluitend met een schone, zachte doek.

Voorkom harde stoten en laat het toestel niet vallen. De nauwkeurigheid van het toestel dient te worden gecontroleerd als het gevallen is of aan andere mechanische belastingen werd blootgesteld.

Vereiste reparaties aan dit laserapparaat mogen alleen worden uitgevoerd door geautoriseerd vakpersoneel.

Gebruik het instrument niet in ruimten met explosiegevaar of in een agressieve omgeving.

Gebruik uitsluitend acculaders aanbevolen door de fabrikant van de batterijen.

 Lege batterijen mogen niet bij het huisvuil worden weggegooid. Denk aan het milieu en lever ze in bij de beschikbare inzamelpunten in overeenstemming met nationale en lokale regels. Het product mag niet bij het huisvuil worden weggegooid. Het product moet in overeenstemming met de nationale regelgeving van uw land worden verwijderd. Houdt u aan de nationale en landspecifieke regelgeving. Neem voor informatie over de afvoer contact op met uw gemeente of vakhandelaar.



TECHNISCHE GEGEVENS

Veiligheidsklasse	IP54 (tegen stof en spatwater beschermd)
Optiek	14 mm
Brandpunt	35 mm
Meetbereik max.	50 meter (tolerantie: 55m)
Meetbereik min.	0,05 meter
Absolute nauwkeurigheid @ < 10m	± 1,5 mm (max.)
Herhalingsnauwkeurigheid @ < 10m	± 1,5 mm (karakteristiek max. 2σ)
Herhalingsnauwkeurigheid @ > 10m	stijging ± 0,25 mm / meter (karakteristiek max. 2σ)
Meettijd	0,5 s
Displaytype	lcd (22,7 mm x 31 mm)
Stroomvoorziening	AAA 2x (alkaline-batterij)
Batterijlevensduur	10.000 (afzonderlijke metingen)
Uitgangsvermogen van de laser	0,6 mW ~ 0,95 mW (class 2, 650nm)
Grootte van de laserpunt	25 x 30 mm @ 16 m (max.)
Laserstraal verticale hoek	+1 graad
Laserstraal horizontale hoek	±1 graad
Automatische uitschakeling toestel	180 seconden
Automatische uitschakeling laser	30 seconden
Arbeidstemperatuurbereik	-10°C tot +50°C
Opslagtemperatuurbereik	-25°C tot +70°C
Gewicht zonder batterij	80 g

VOORGESCHREVEN GEBRUIK VAN HET SYSTEEM

Het lasermeettoestel is geschikt voor het meten van afstanden en neigingen.
Dit apparaat uitsluitend gebruiken voor normaal gebruik, zoals aangegeven.

TABEL MET STORINGSCODES

Code	Beschrijving	Maatregel
Err01	Buiten het meetbereik	Meting uitvoeren in voorgeschreven bereik.
Err02	Reflecterend signaal is te zwak	Een beter oppervlak kiezen.
Err03	Buiten het weergavebereik (max. waarde: 99.999) bijv. het resultaat van een oppervlak of volume buiten het weergavebereik	Controleer of de waarden en stappen correct zijn.
Err04	Fout in de Pythagorasberekening	Controleer of de waarden en stappen correct zijn.
Err05	Batterij zwak	Nieuwe batterij plaatsen.
Err06	Buiten het arbeidstemperatuurbereik	Meting uitvoeren in het voorgeschreven arbeidstemperatuurbereik.
Err07	Omgevingslicht te fel	Doelbereik donkerder maken.

Pythagoras
Hoogteverschil

Meetniveau

Lengtemeting

Minimum / maximum voor constante meting

Optellen / aftrekken

Oppervlak / volume
Indirecte oppervlaktemeting

Batterijstatus

geheugen

Timer

Constante meting

Tussenwaarden

Totale waarde

AAN / METEN

- ▶ Aan
- ▶ Meten
- ▶ Constante meting (2 sec. indrukken)
Min./max.-functie

OPTELLEN

- ▶ Waarde optellen
- ▶ Navigeren in het geheugen

OPPERVLAK / VOLUME

- ▶ Oppervlak (1x indrukken)
- ▶ Volume (2x indrukken)
- ▶ Indirecte oppervlaktemeting (3x / 4x indrukken)

INSCHAKELEN

- ▶ Aan
- ▶ Uit (2 sec. indrukken)
- ▶ Terugzetten

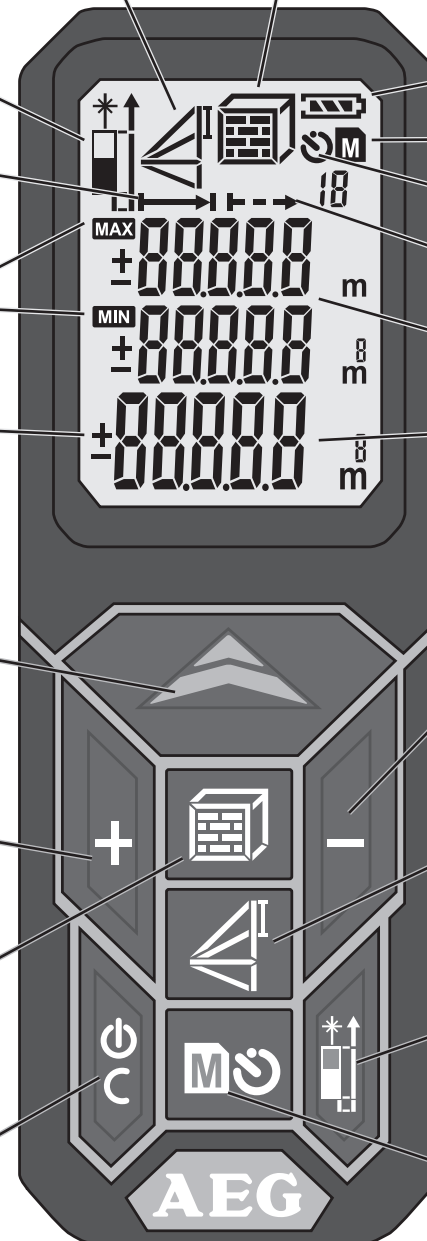

AFTREKKEN

- ▶ Waarde aftrekken
- ▶ Navigeren in het geheugen

PYTHAGORAS

- ▶ Pythagoras 1 (1x indrukken)
- ▶ Pythagoras 2 (2x indrukken)
- ▶ Pythagoras 3 (3x indrukken)

MEETNIVEAU OMSCHAKELEN

- ▶ Voor
- ▶ Achter
- ▶ Hoekpen

GEHEUGEN

- ▶ Timer 3-15 sec. (1x indrukken)
- ▶ Geheugen 1-20 (1x 2 sec. indrukken)
- ▶ Met de toetsen +/- in het geheugen navigeren

VERVANGEN VAN DE BATTERIJEN

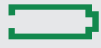
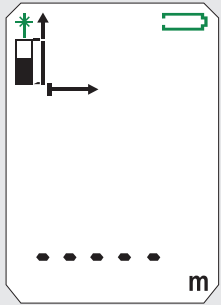

Vervang de batterij als het symbool begint te knippen.

1

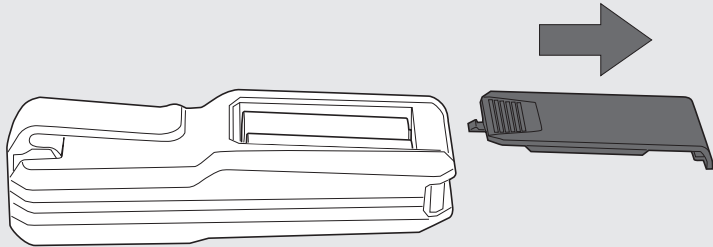

2

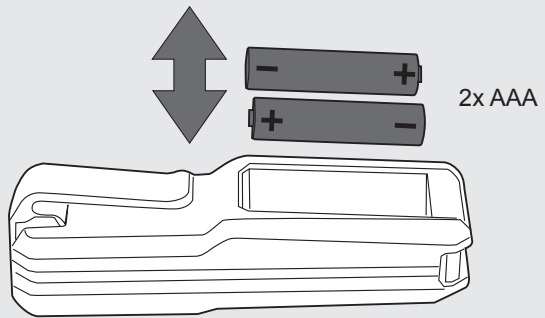

3

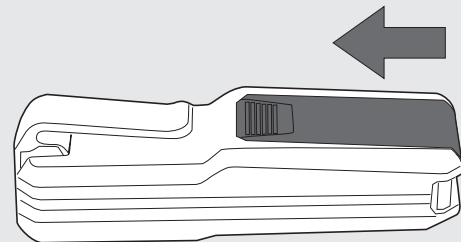

HOEKPEN

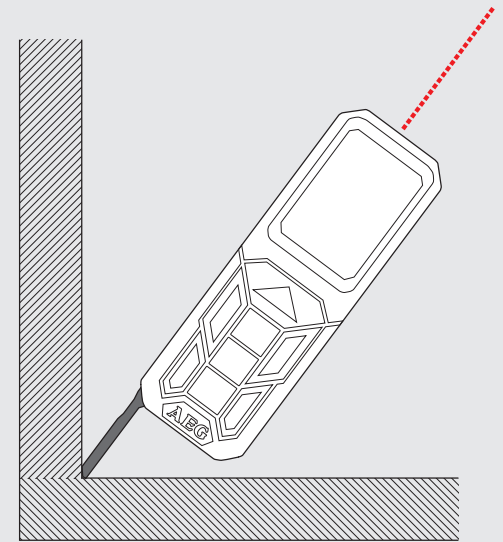
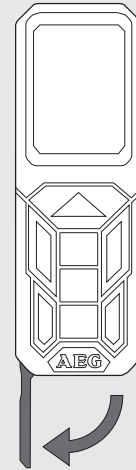

RIEMHOUDER

1

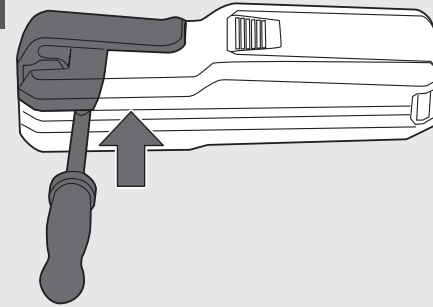

2

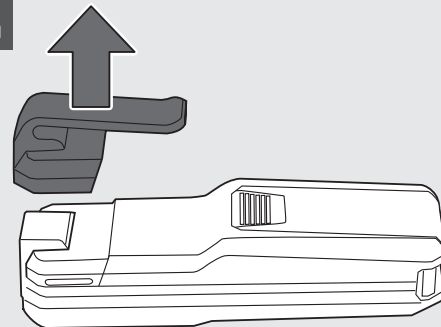

3

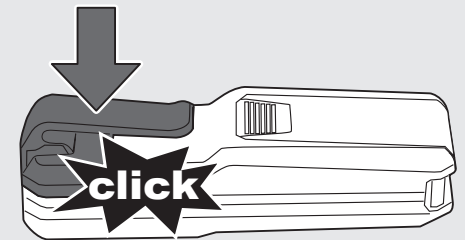

FUNCTIETOETS, PYTHAGORAS, MEETNIVEAU

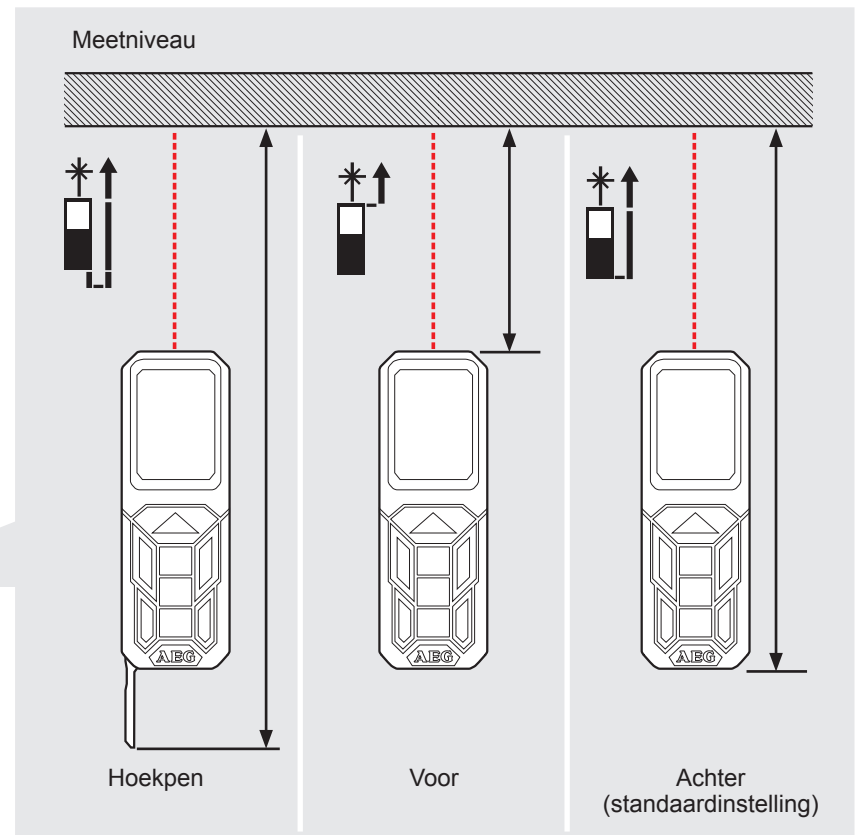
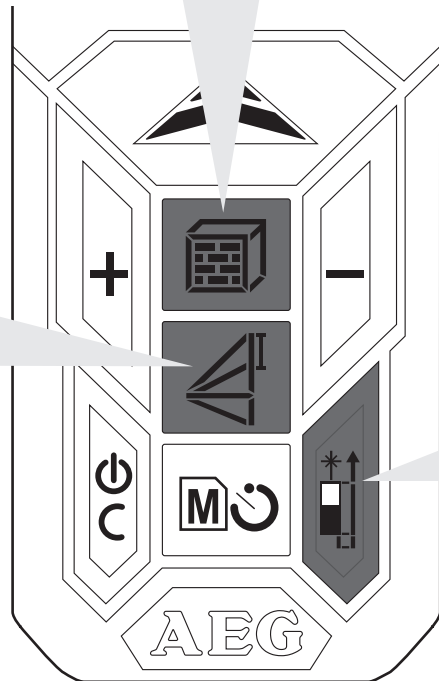
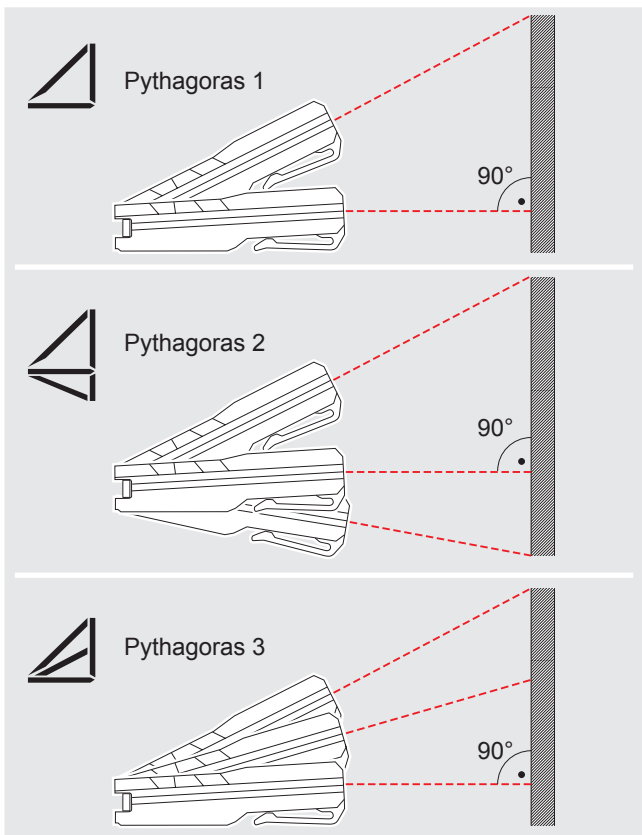
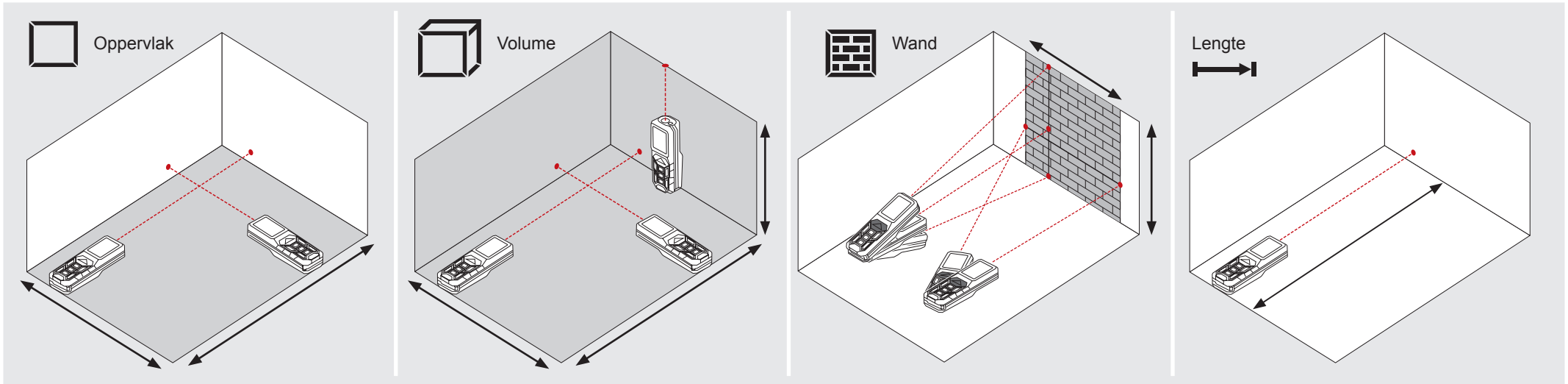

EENVOUDIGE LENGTEMETING

0	1	2	3	4

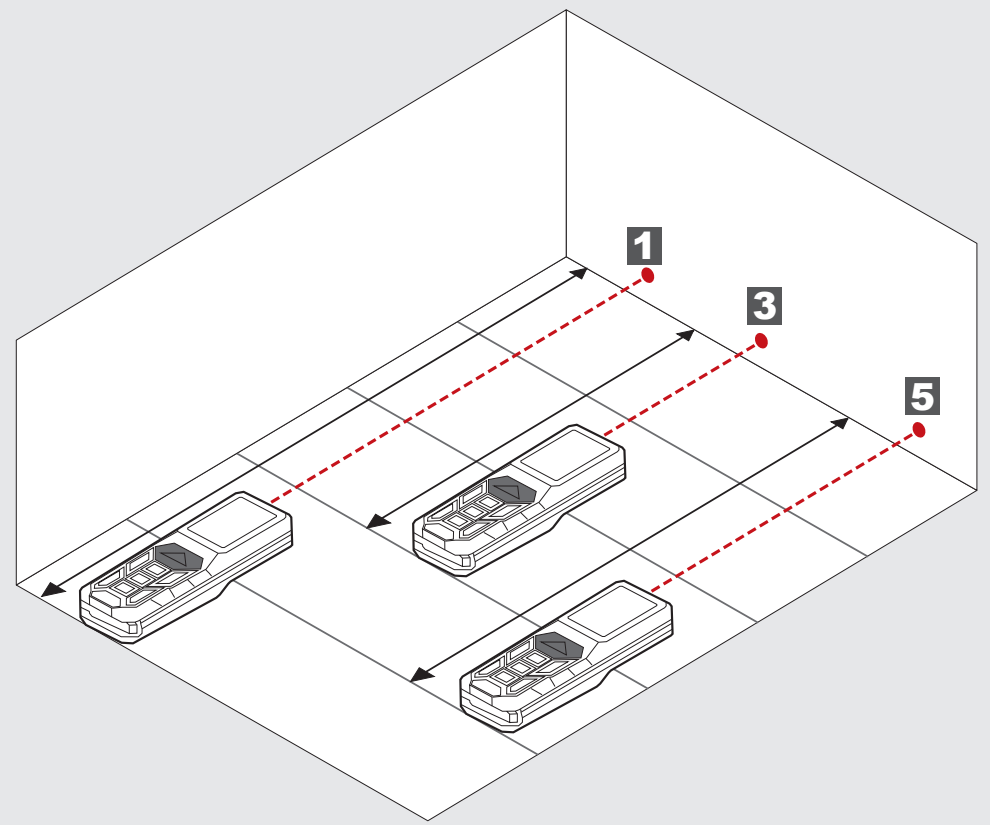

5

CONSTANTE METING / MINIMUM-/MAXIMUM-METING

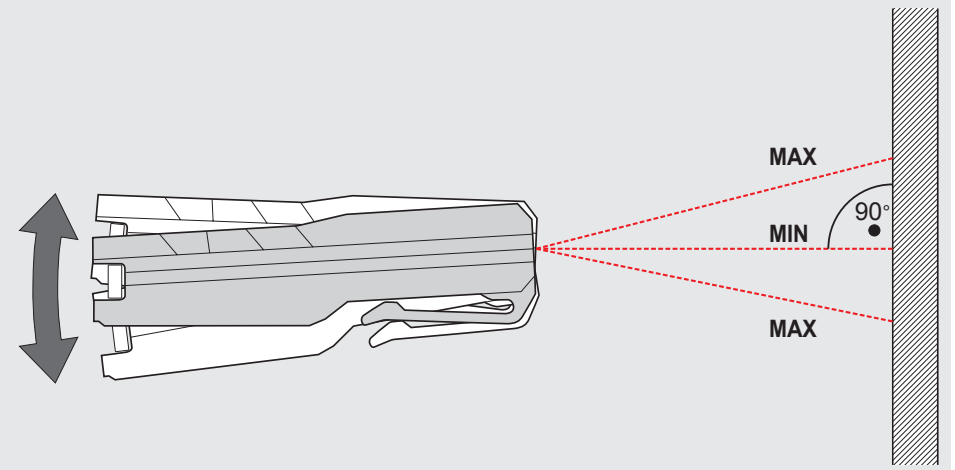
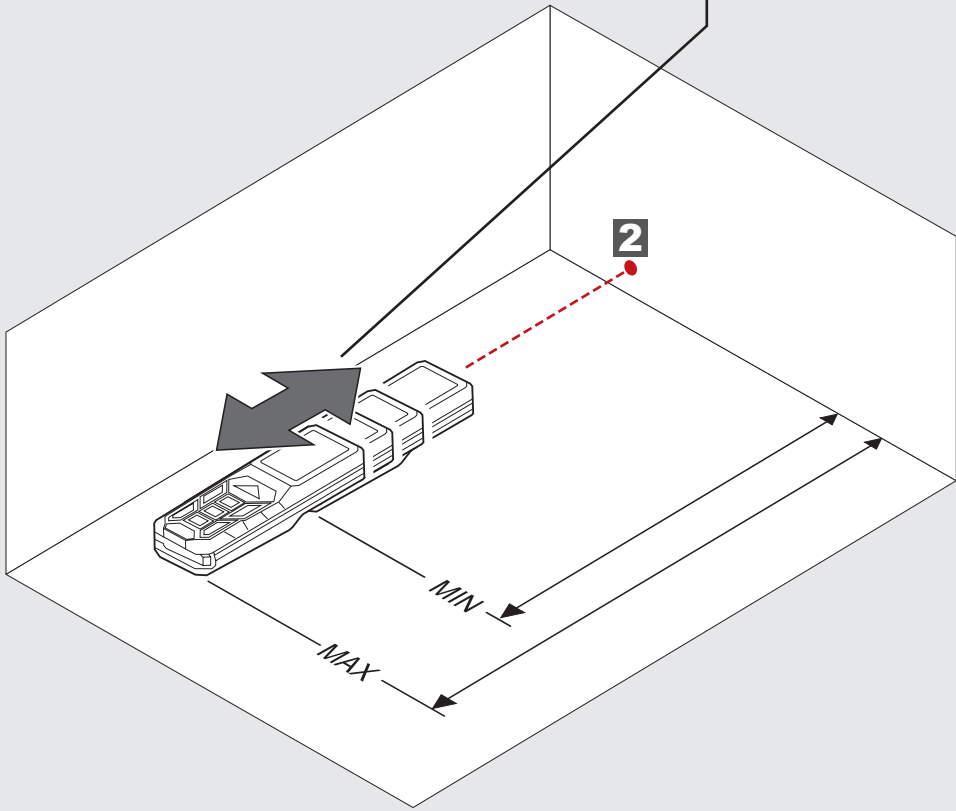
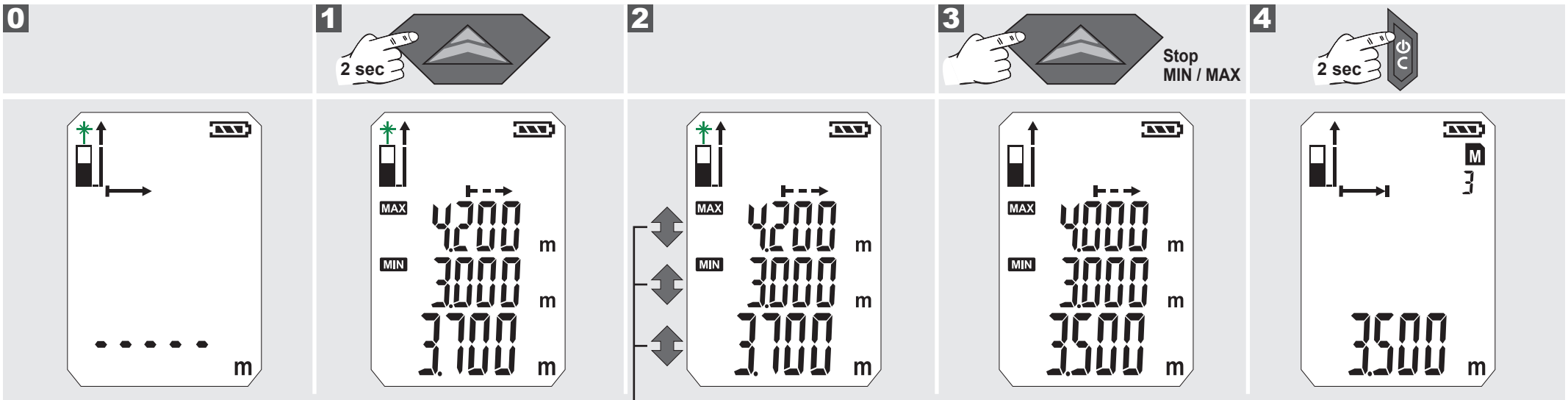

0

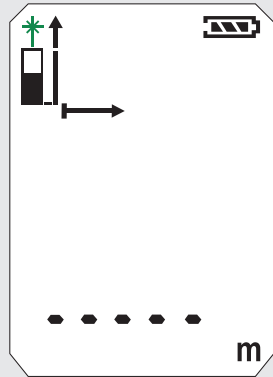

1

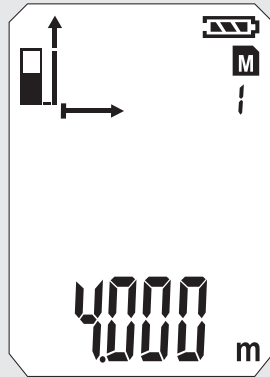
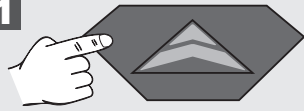

2

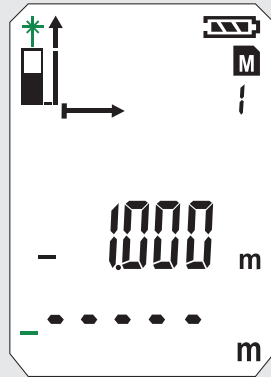
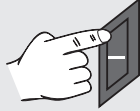

3

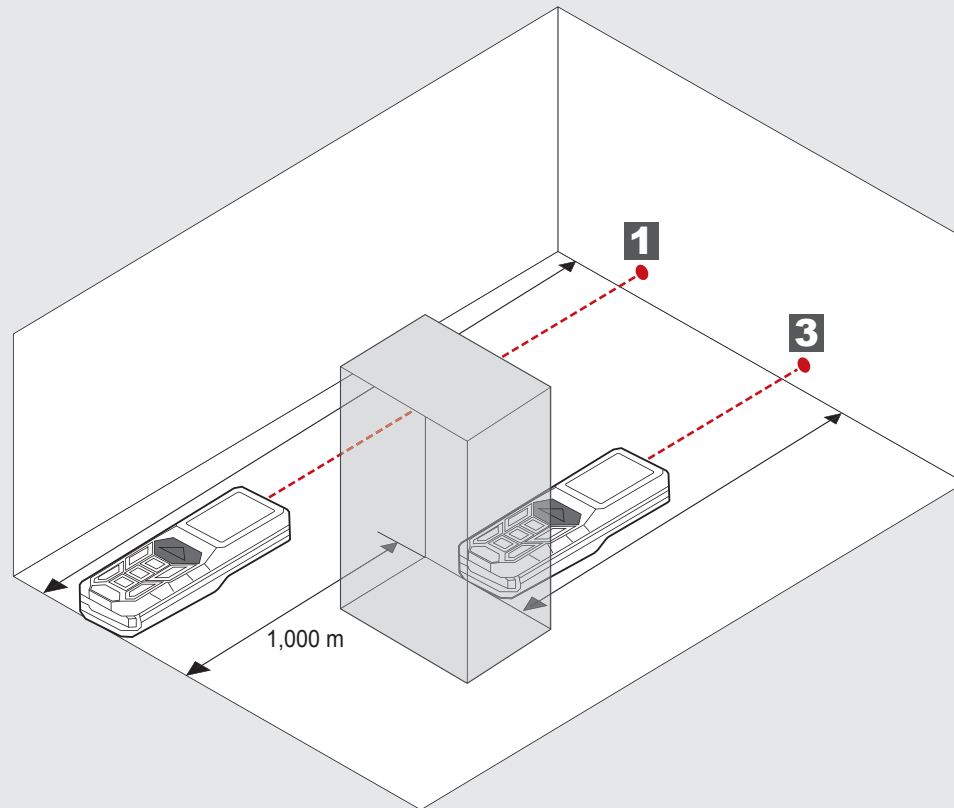
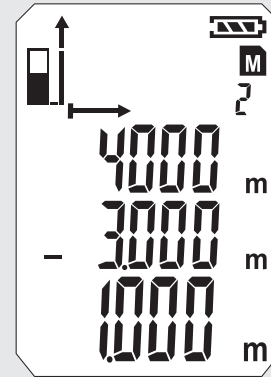
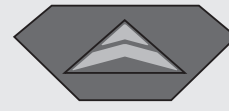

OPPERVLAKMETING

0



1

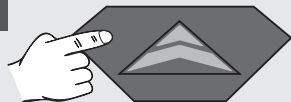

2

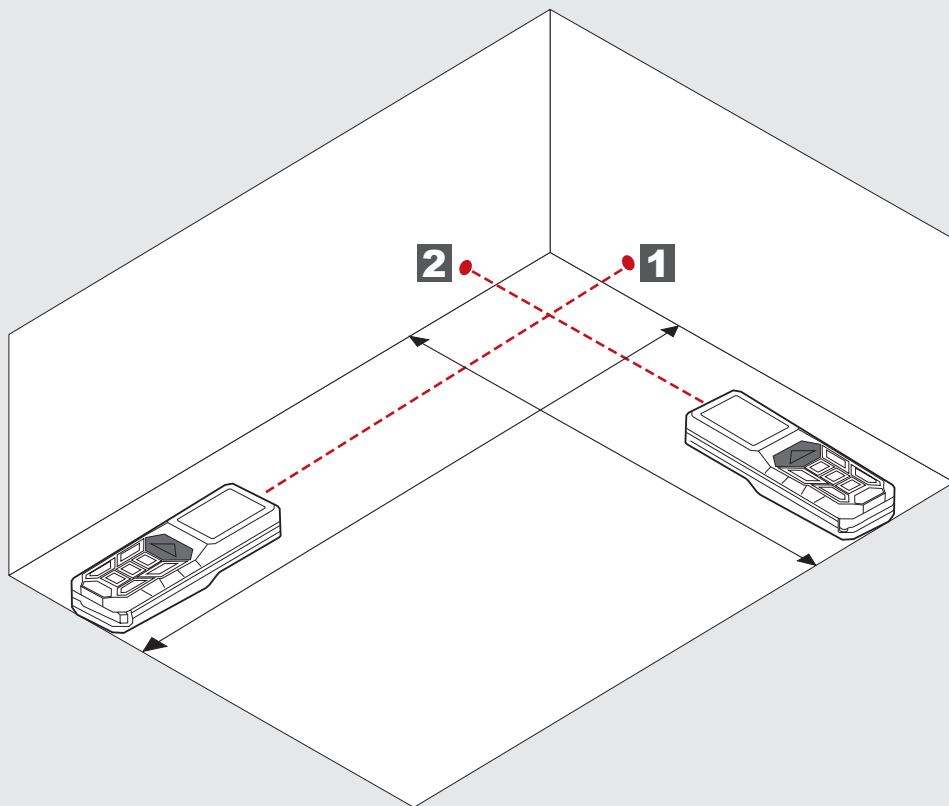
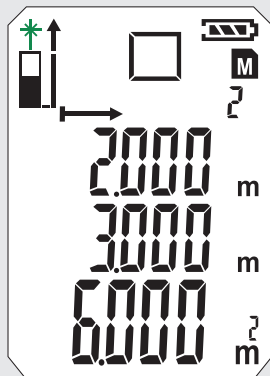
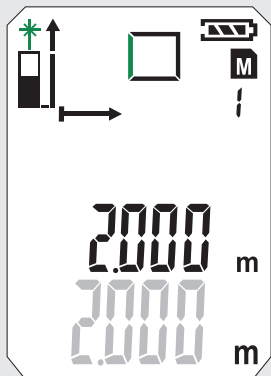
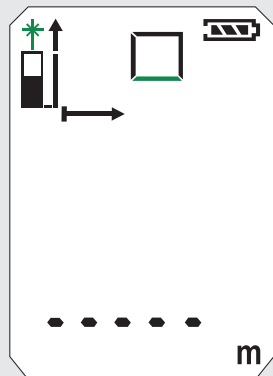
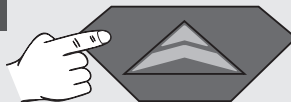

VOLUMEMETING

0

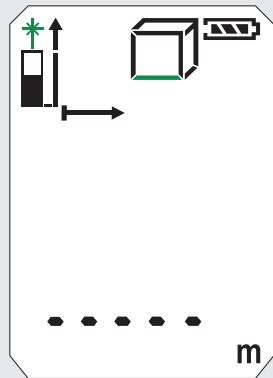

1

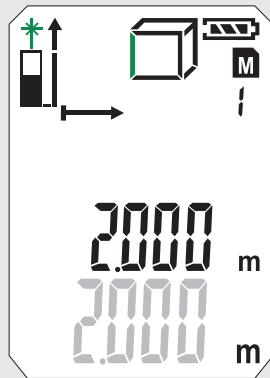
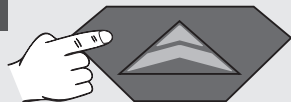

2

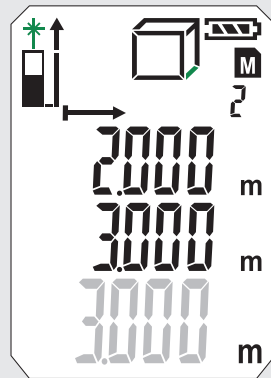
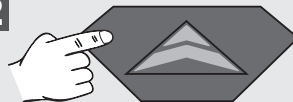

3

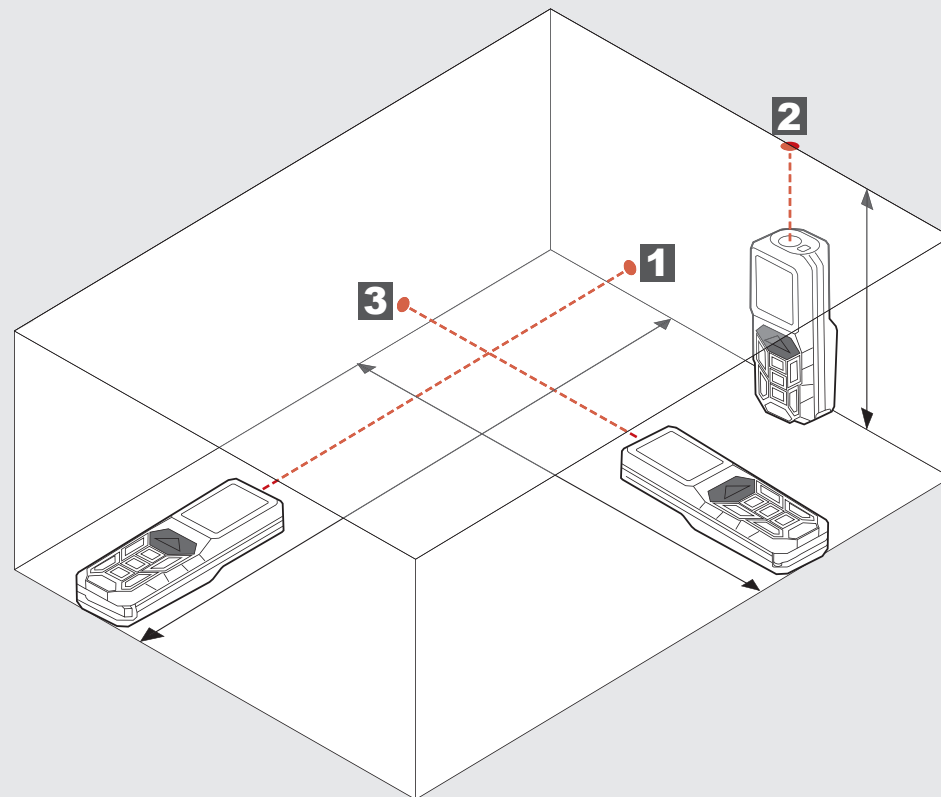
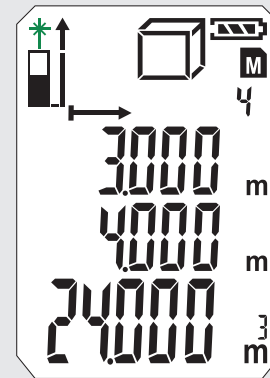
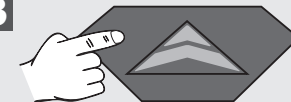

INDIRECTE METING (PYTHAGORAS 1)

0



1

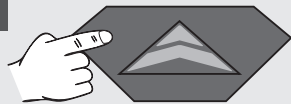

2

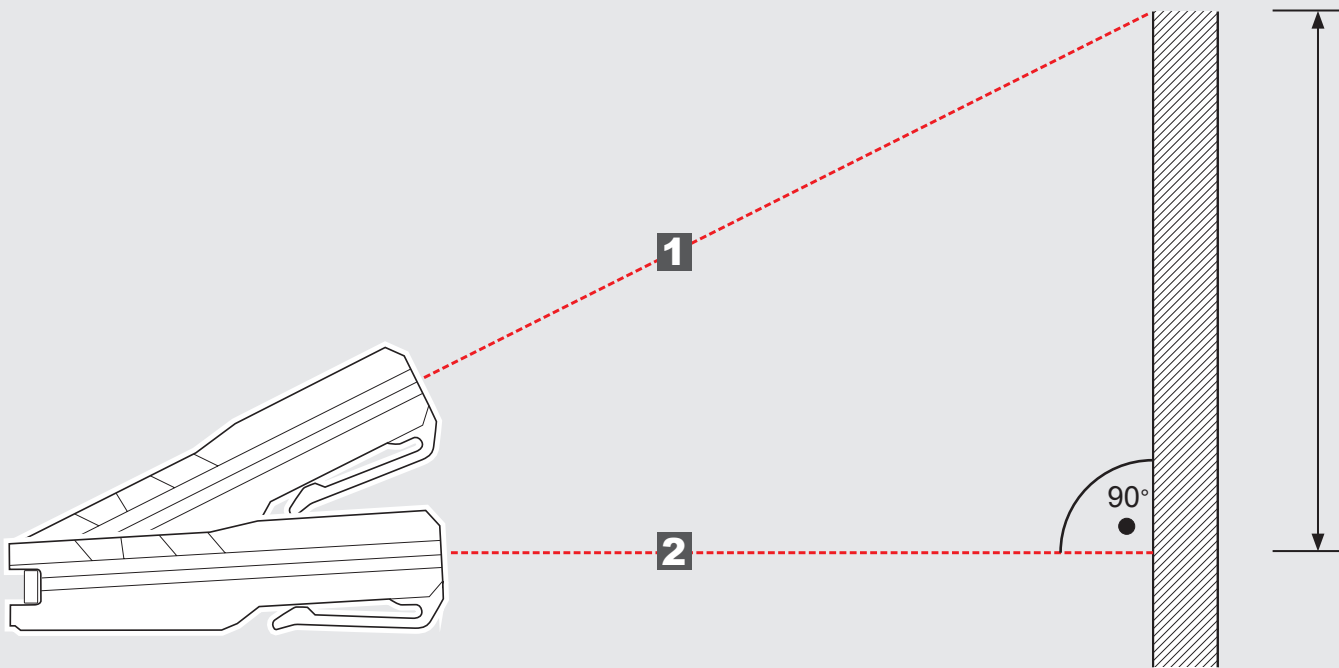
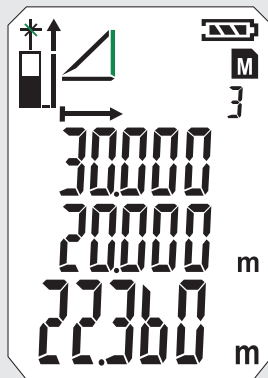
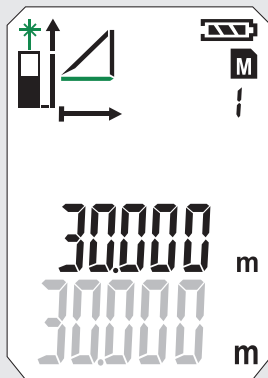
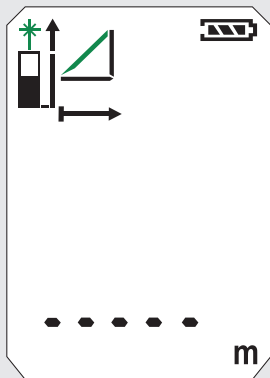
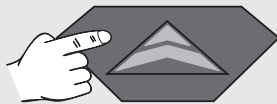

INDIRECTE METING (PYTHAGORAS 2)

0



1

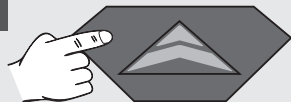

2



3

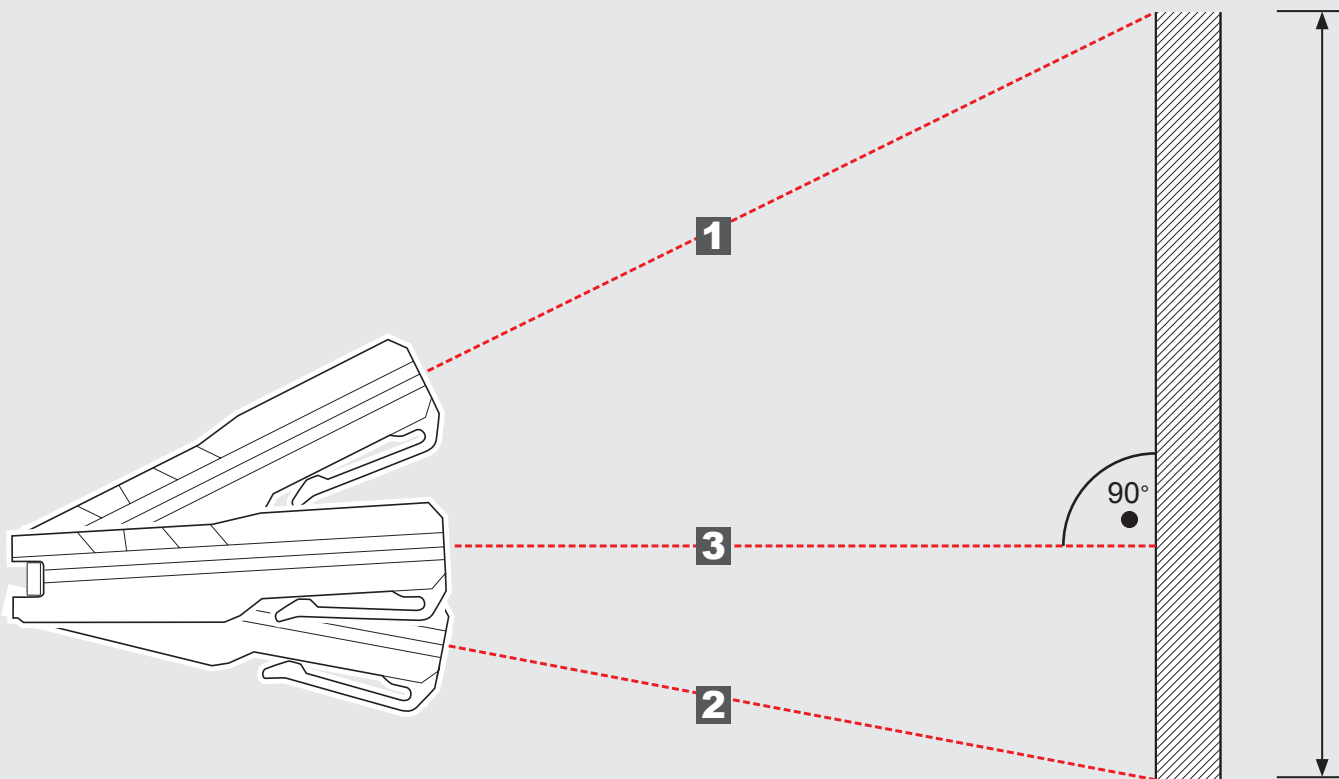
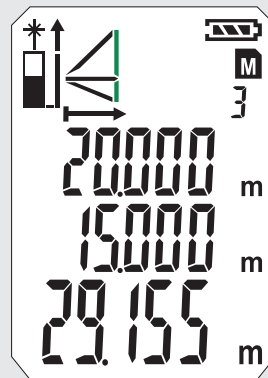
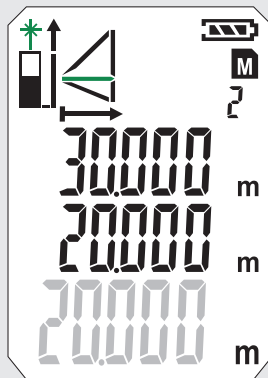
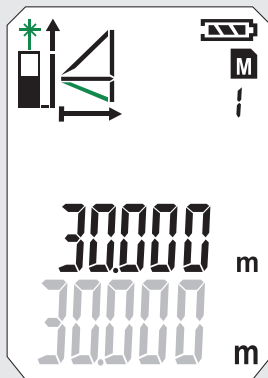
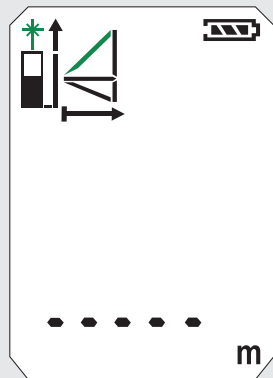

INDIRECTE METING (PYTHAGORAS 3)

1



2

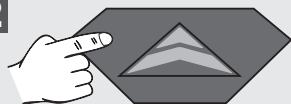

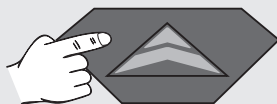

3



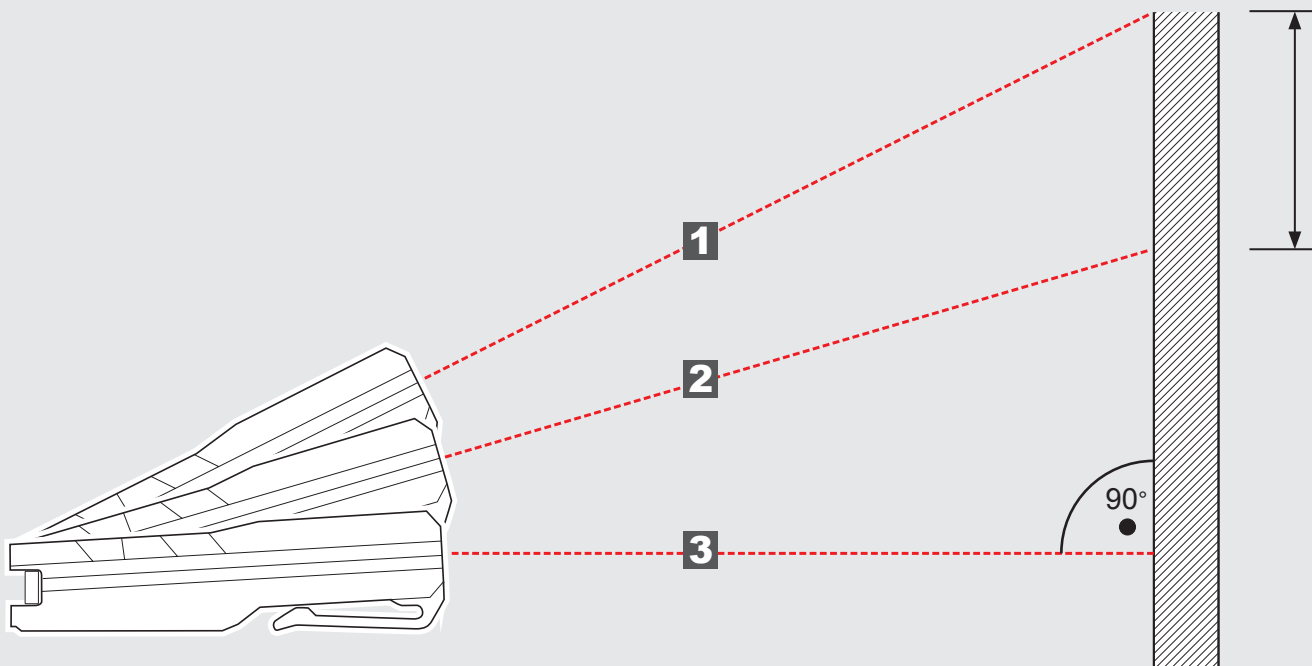
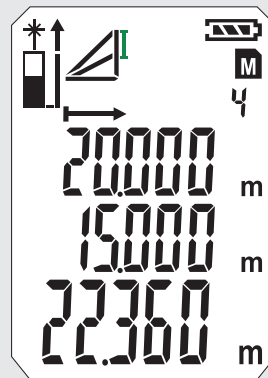
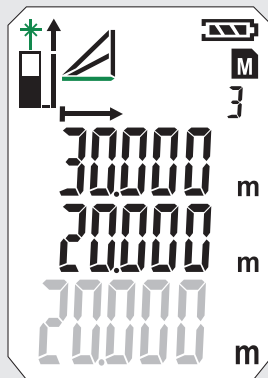
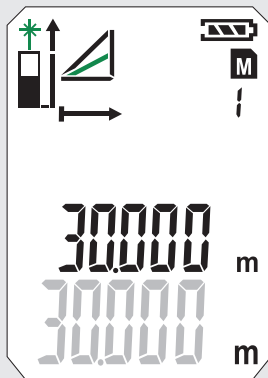
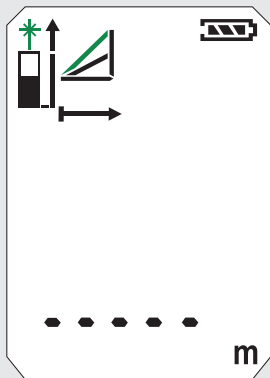

4

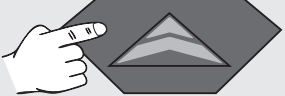
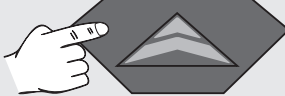
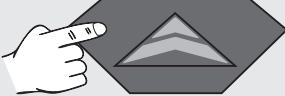
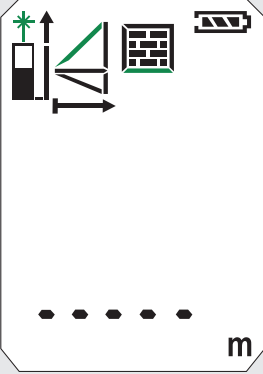
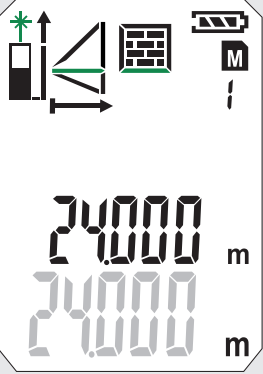
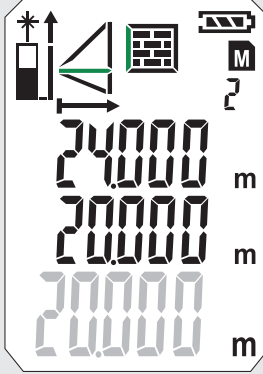
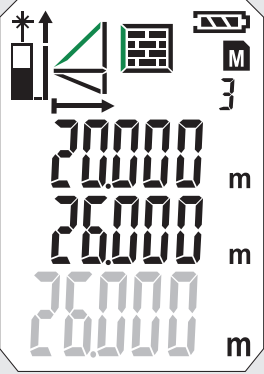
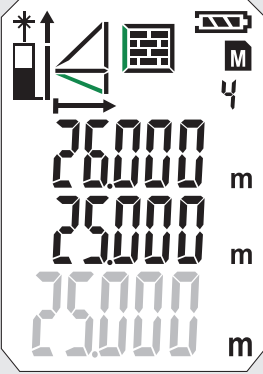

WANDOPPERVLAKMETING (SCENARIO 1)

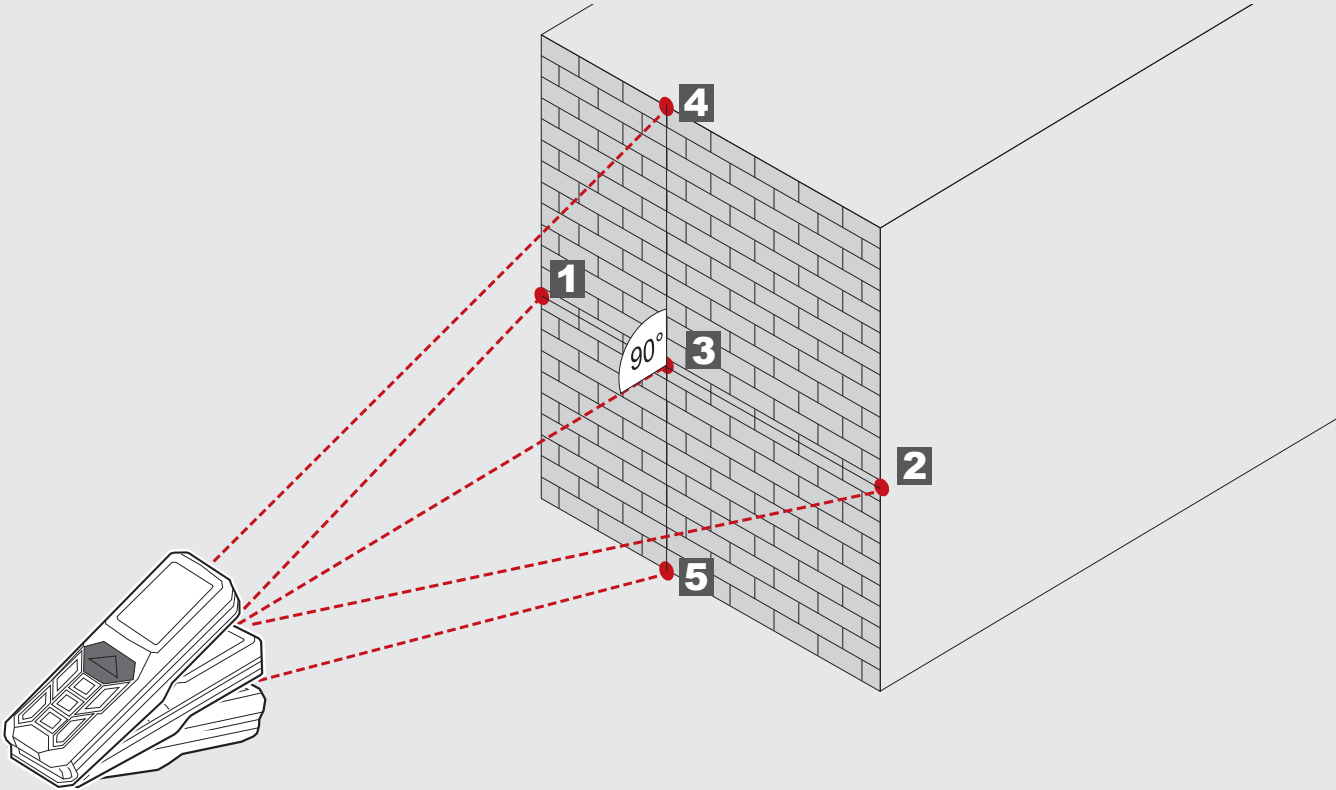
0 	1 	2 	3 	4 
				



5

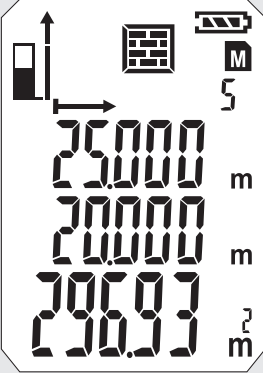

TIMER

Met de timer kan de meting vertraagd worden geactiveerd om bijv. een onderdeel in de meetstraal te kunnen plaatsen.

Toets  indrukken

- Symbool verschijnt
- Door het indrukken van de toets  kan de timer tussen 3 en 15 sec. worden ingesteld.

Toets  indrukken

- De seconden tot de meting worden teruggeteld.
- Bij 0 wordt de meting geactiveerd.

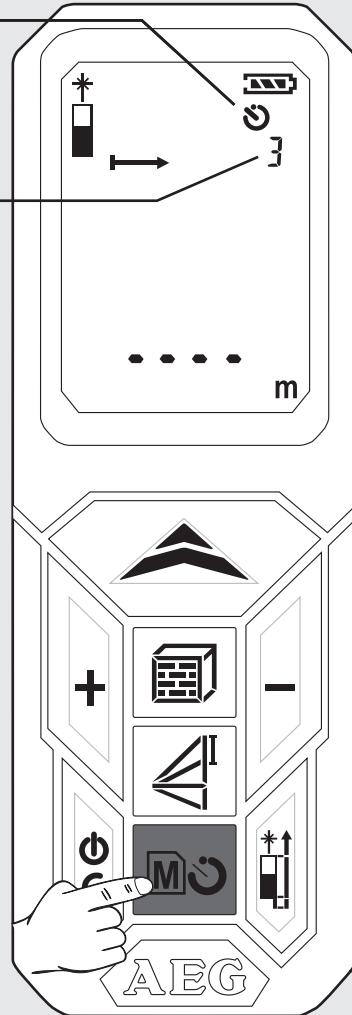

GEHEUGEN

De meetwaarden worden automatisch doorlopend in het geheugen opgeslagen.

De opgeslagen waarden kunnen worden opgeroepen met behulp van de toets .

Toets  2 sec. lang indrukken

- Het symbool en de geheugenplaats verschijnen.
- De bijbehorende meeteenheid wordt weergegeven.
- De opgeslagen waarde wordt in de hoofdregel weergegeven.
- Met de toetsen +/- navigeren

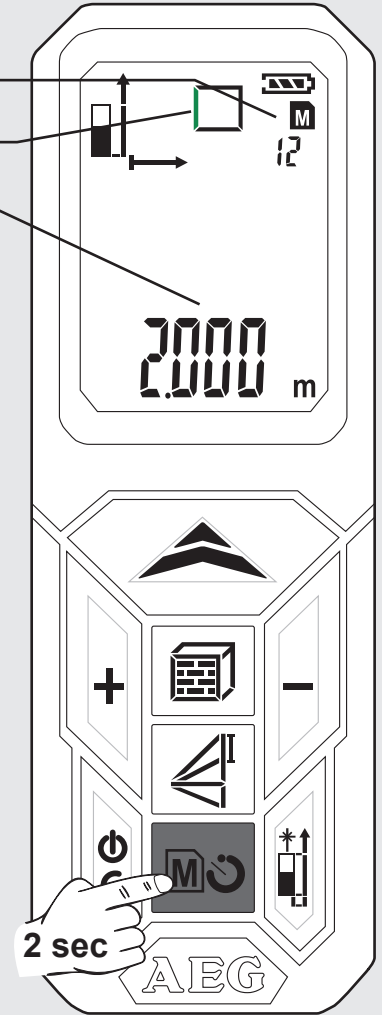



PRINCIPIËLE WERKING AAN DE HAND VAN EEN OPPERVLAKMETING (1)

1 Inschakelen

Toets  indrukken.
⚠ Opgelet! Laserstraal inschakelen!
 Niet op personen richten!

Het lasersymbool knippert (knipperen wordt groen weergegeven).

2 Meetniveau selecteren

Standaardinstelling na het inschakelen: achter
 1x indrukken -> hoekpen
 2x indrukken -> voor
 3x indrukken -> achter

Symbol wordt weergegeven

3 Functie kiezen

Na het inschakelen staat het apparaat altijd ingesteld op lengtemeting.
 1x indrukken - oppervlakmeting

- Het symbool verschijnt
 - De meeteenheid knippert (knipperen wordt groen weergegeven).

4 Lengte meten

Het toestel uitlijnen en toets  indrukken

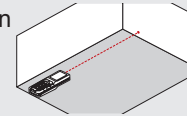

- De meetwaarde verschijnt kort in de hoofdregel.
 - De meetwaarde springt na 1 sec. naar de daarboven liggende regel.
 Meetwaarde wordt in het geheugen opgeslagen onder een volgnummer.
 Tweede meeteenheid knippert. Het toestel is gereed voor de meting van de tweede waarde.

5 Breedte meten

Het toestel uitlijnen en toets  indrukken

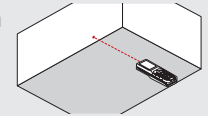

- De meetwaarde verschijnt kort in de hoofdregel.
 - De meetwaarde springt na 1 sec. naar de daarboven liggende regel.
 Meetwaarde wordt in het geheugen opgeslagen onder een volgnummer.
 - Het resultaat verschijnt in de hoofdregel en wordt in het geheugen opgeslagen onder het volgnummer.

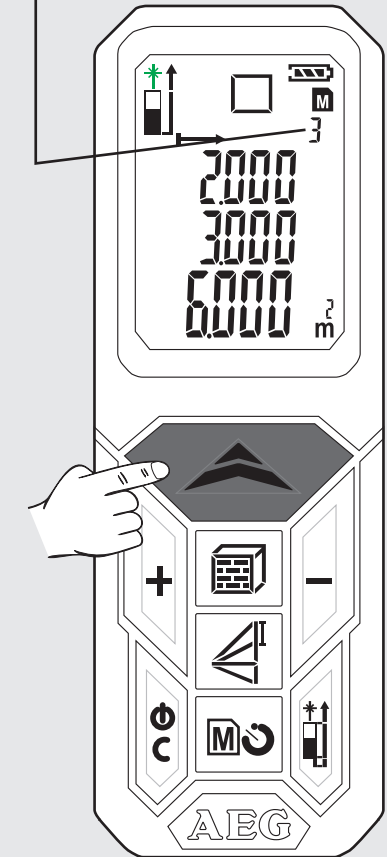
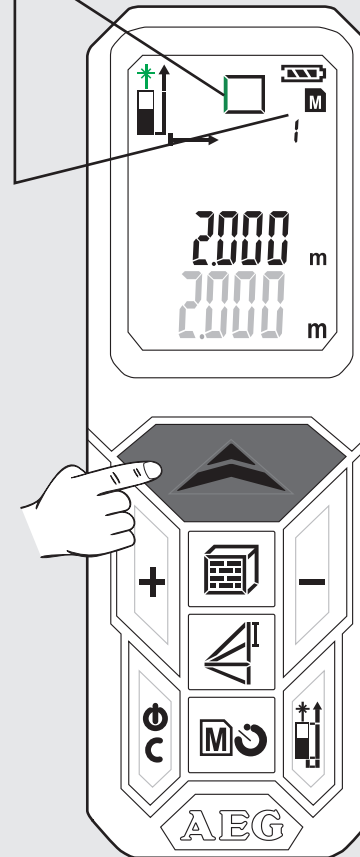
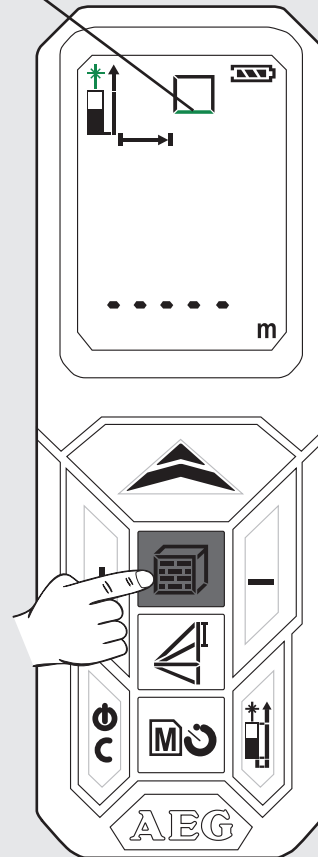
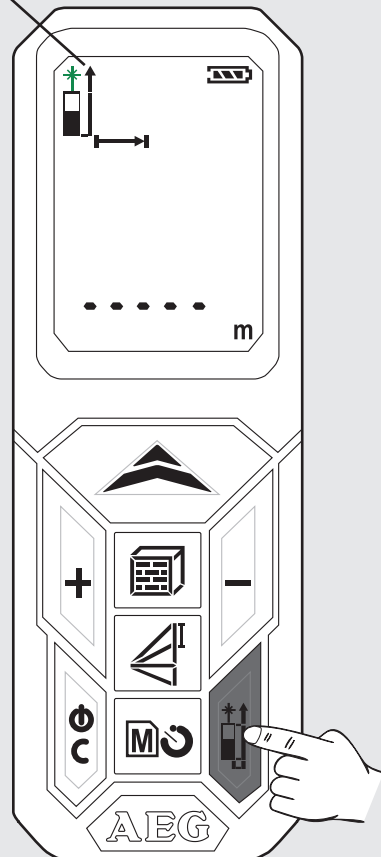
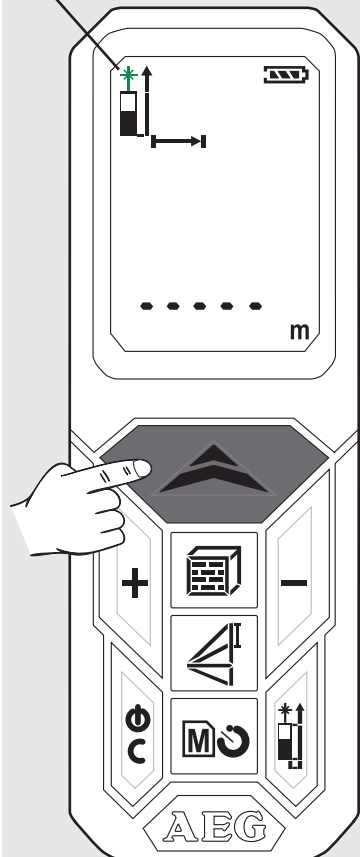

PRINCIPIËLE WERKING AAN DE HAND VAN EEN OPPERVLAKTEMETING (2)

6 Opgeslagen waarde oproepen

De toets  2 sec. lang indrukken.

De toets + of - indrukken.

7 Geheugen verlaten

De toets  indrukken

8 Uitschakelen

De toets  2 sec. lang indrukken (het geheugen moet eerst worden verlaten).

- De opgeslagen waarden worden in de hoofdregel weergegeven.

- Het bijbehorende symbool wordt weergegeven en de meeteenheid knippert (knipperen wordt groen weergegeven).

- Het toestel schakelt uit.

- Als gedurende 3 minuten geen toets wordt ingedrukt, schakelt het toestel automatisch uit.

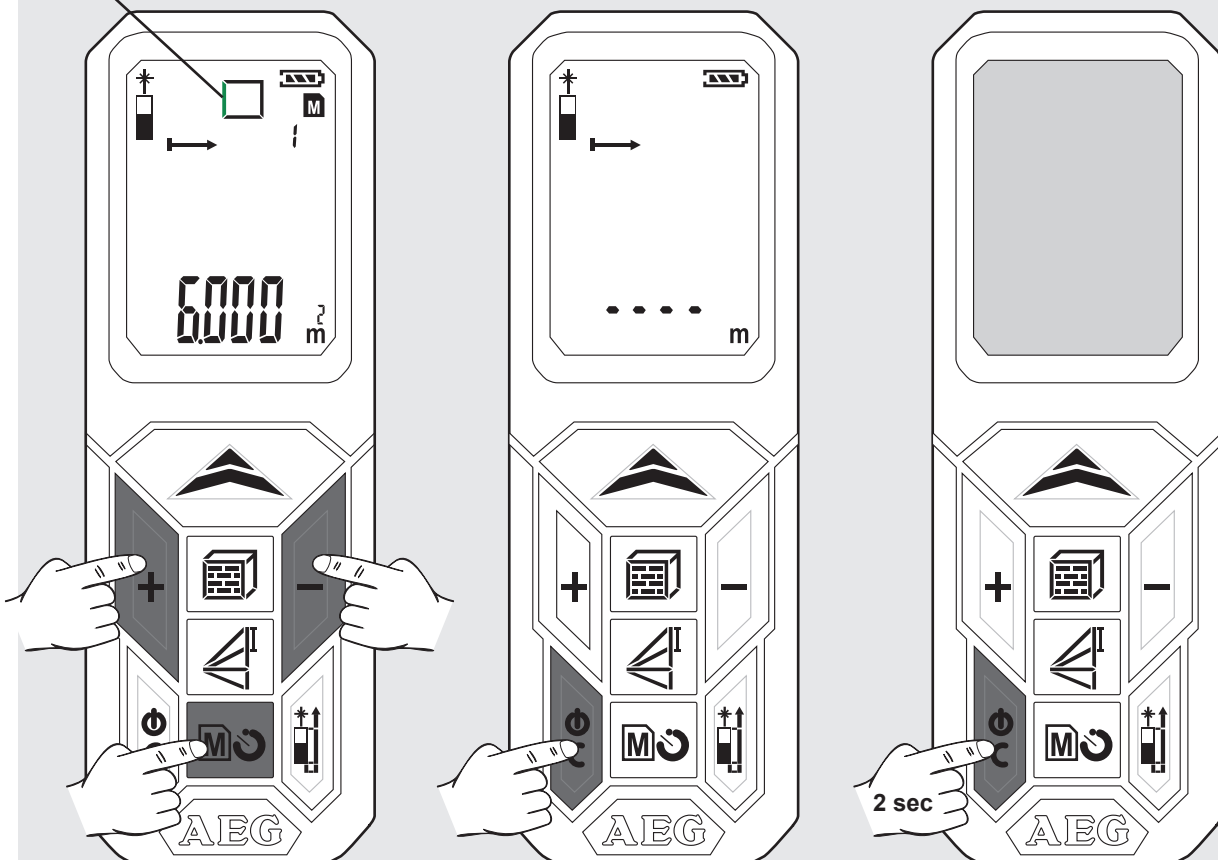

INDHOLD

Vigtige sikkerheds- instruktioner.....1
 Tekniske data.....2
 Tiltænkt Formål.....2
 Fejlkode Tabel2
 Oversigt.....3
 Skift batteri.....4
 Hjørnestift4
 Bælteclips4
 Funktionstast, pythagoras, målereference5
 Enkelt afstandsmåling6
 Konstant måling / minimum-maksimum måling.....7
 Additions- / subtraktionsmåling.....8
 Arealmåling.....9
 Volumenmåling.....10
 Indirekte måling (pythagoras 1).....11
 Indirekte måling (pythagoras 2).....12
 Indirekte måling (pythagoras 3).....13
 Måling af vægareal (scenario 1).....14
 Måling af vægareal (scenario 2).....15
 Timer16
 Hukommelse.....16
 Grundlæggende funktionsmåde vist med et eksempel på en arealmåling (1).....17
 Grundlæggende funktionsmåde vist med et eksempel på en arealmåling (2).....18

VIGTIGE SIKKERHEDS- INSTRUKTIONER

 Brug ikke produktet før du har læst sikkerhedsinstruktionerne og brugervejledningen på vedlagte CD.

Laserklassificering

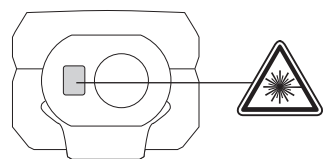

ADVARSEL:
 Det er et Klasse 2 laserprodukt i overensstemmelse med IEC 60825-1:2007.



Mærkning

Inden idriftsættelse første gang skal den medfølgende mærkat med dansk tekst klæbes oven på den engelske tekst på mærkepladen.

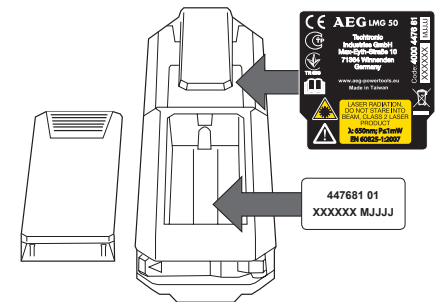

Advarsel:
 Undgå en direkte synskontakt. Laserstrålen kan forårsage "blitz blindhed" og føre til en kortvarig blænding.

Se aldrig ind i laserstrålen og ret den ikke unødigt mod andre personer.
 Blænd ikke andre personer.

Advarsel:
 Betjen ikke laserapparatet i nærheden af børn eller tillad ikke børn at benytte laserapparatet.

OBS!! En reflekterende overflade kunne reflektere laserstrålen tilbage til brugeren eller andre personer.
 Hold arme og ben i sikker afstand fra bevægelige dele.

Udfør regelmæssige testmålinger. Især før, under og efter vigtige målinger.

Vær opmærksom på fejl-målinger, hvis produktet er defekt, eller hvis det er blevet tabt eller er blevet misbrugt eller modificeret.

Pas på! Gør dig fortrolig med haveværktøjets betjeningsanordninger og korrekte anvendelse.

Laserafstandsmåleren har grænser for sit anvendelsesområde. (Se afsnittet "Tekniske data"). Det vil forårsage unøjagtigheder at forsøge at måle uden for det maksimale og minimale område. Bruges instrumentet ved ugunstige betingelser som hvis det er for varmt eller for koldt, meget kraftigt sollys, regn, sne, tåge eller andre sigtbegrænsende betingelser kan det føre til unøjagtige målinger.

Hvis laserafstandsmåleren kommer fra varme omgivelser til kolde (eller omvendt), så vent, indtil den har tilpasset sig til den nye omgivelsestemperatur.

Opbevar altid laserafstandsmåleren indendørs, beskyt den mod stød, vibrationer eller ekstreme temperaturer.

Beskyt laserafstandsmåleren mod støv, fugtighed og høj luftfugtighed. Dette kan ødelægge indvendige komponenter eller påvirke nøjagtigheden.

Brug ikke aggressive rengøringsmidler eller opløsningsmidler. Rengør kun instrumentet med en ren, blød klud.

Undgå at laserafstandsmåleren udsættes for kraftige stød eller at tabe den. Instrumentets nøjagtighed skal kontrolleres, hvis det er faldet ned eller har været udsat for andre mekaniske belastninger.

Nødvendige reparationer på dette laserapparat skal udføres af autoriserede fagfolk.

Brug ikke produktet i områder med eksplosions-fare eller under barske forhold.

Brug kun opladere anbefalet af producenten til opladning af batterierne.

 Brugte batterier må ikke smides ud med husholdningsaffaldet. Skån miljøet og tag dem til opsamlingsstederne i overensstemmelse med nationale eller lokale regler. Produktet må ikke smides ud med husholdningsaffaldet. Smid produktet ud i overensstemmelse med de gældende nationale regler i dit land. Følg de nationale og landespecifikke regler. Henvend dig til de lokale myndigheder eller din forhandler for at få oplysning om bortskaffelsen.



TEKNISKE DATA

Kapslingsklasse	IP54 (støv- og stænkvandsbeskyttet)
Modtagelinse	14 mm
Fokus	35 mm
Maks. måleområde	50 meter (tolerance: 55m)
Min. måleområde	0,05 meter
Absolut nøjagtighed @ < 10m	± 1,5 mm (maks.)
Gentagelsesnøjagtighed @ < 10m	± 1,5 mm (typisk maks. 2σ)
Gentagelsesnøjagtighed @ > 10m	stigning ± 0,25 mm / meter (typisk maks. 2σ)
Måletid	0,5 s
Display type	LCD (22,7 mm x 31 mm)
Strømforsyning	AAA 2x (alkaline batteri)
Batteriets levetid	10000 (enkelt måling)
Laser udgangseffekt	0,6 mW ~ 0,95 mW (klasse 2, 650nm)
Laserpunktstørrelse	25 x 30 mm @ 16 m (maks.)
Laserstråle vertikalvinkel	+1 grad
Laserstråle horisontalvinkel	±1 grad
Automatisk slukning af instrumentet	180 sekunder
Automatisk slukning af laser	30 sekunder
Arbejdstemperatur område	-10°C op til +50°C
Opbevaringstemperatur område	-25°C op til +70°C
Vægt uden batteri	80 g

TILTÆNKT FORMÅL

Laserafstandsmåleren er egnet til måling af afstande og hældninger.

Produktet må ikke anvendes på anden måde og til andre formål end foreskrevet.

FEJLKODE TABEL

Kode	Beskrivelse	Løsning
Err01	Uden for måleområdet	Foretag målingen i det korrekte område.
Err02	Reflekterende signal er for svagt	Vælg en bedre overflade.
Err03	Uden for visningsområdet (maks. værdi: 99.999) f.eks. er resultatet af areal eller volumen uden for visningsområdet	Kontrollér, at værdier og trin er korrekte.
Err04	Fejl i pythagoras beregningen	Kontrollér, at værdier og trin er korrekte.
Err05	Batteri er svagt	Sæt nye batterier i.
Err06	Uden for arbejdstemperaturens område	Foretag målingen inden for det fastlagte område for arbejdstemperaturen.
Err07	Omgivelseslyset er for stærkt	Sørg for at målområdet er mørkere.

Pythagoras
Højdeforskel

Målereference

Afstandsmåling

Minimum / maksimum for konstant måling

Addition / subtraktion

Areal / volumen
Indirekte arealmåling

Batteristatus

Hukommelse

Timer

Konstant måling

Foreløbige værdier

Totalværdi

TÆND / MÅL

- ▶ Tænd
- ▶ Mål
- ▶ Konstant måling (tryk i 2 sek.)
Min. / maks. funktion

ADDITION

- ▶ Læg værdi til
- ▶ Navigér i hukommelsen

AREAL / VOLUMEN

- ▶ Areal (tryk 1x)
- ▶ Volumen (tryk 2x)
- ▶ Indirekte arealmåling (tryk 3x / 4x)

TÆND FOR INSTRUMENTET

- ▶ Tænd
- ▶ Sluk (tryk 2 sek.)
- ▶ Slet

SUBTRAKTION

- ▶ Træk værdi fra
- ▶ Navigér i hukommelsen

PYTHAGORAS

- ▶ Pythagoras 1 (tryk 1x)
- ▶ Pythagoras 2 (tryk 2x)
- ▶ Pythagoras 3 (tryk 3x)

SKIFT MÅLEREFERENCE

- ▶ Forkant
- ▶ Bagkant
- ▶ Hjørnestift

HUKOMMELSE

- ▶ Timer 3-15 sek. (tryk 1x)
- ▶ Hukommelse 1-20 (tryk 1x i 2 sek.)
- ▶ Navigér med +/- tasterne i hukommelsen

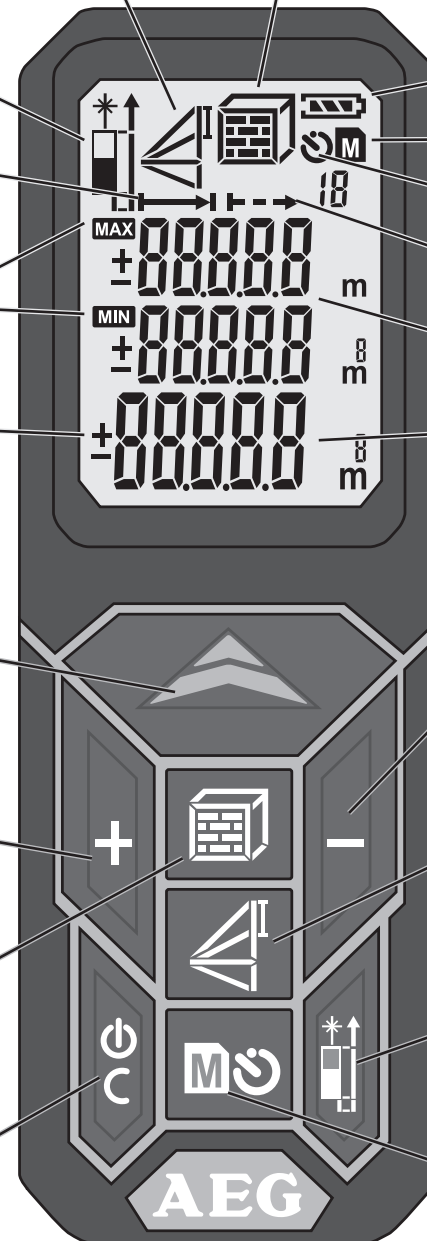

SKIFT BATTERI

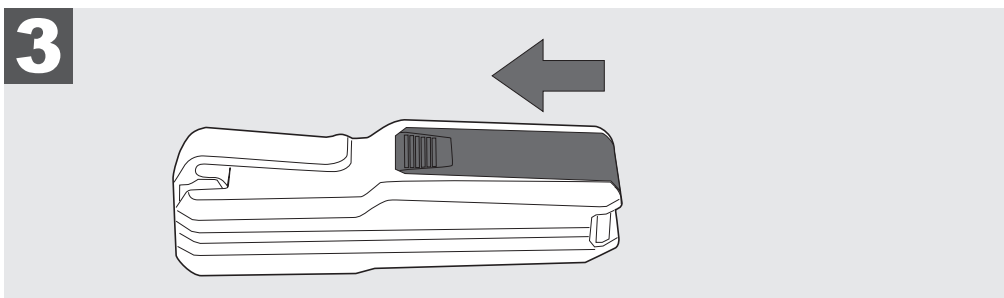
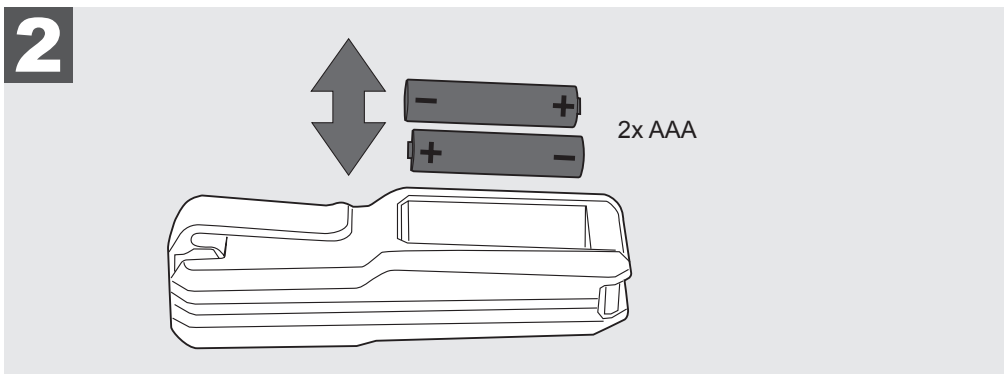
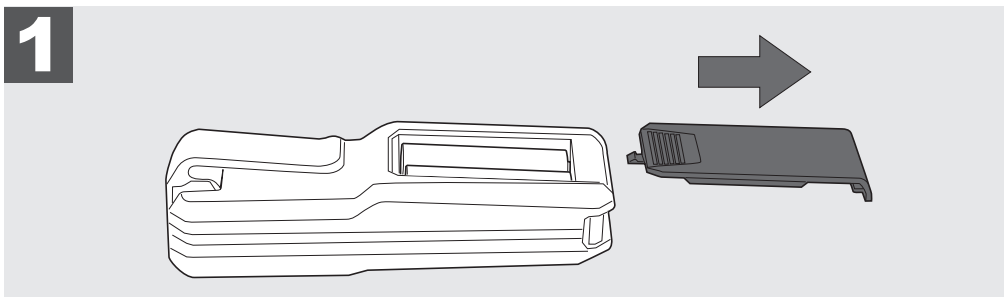
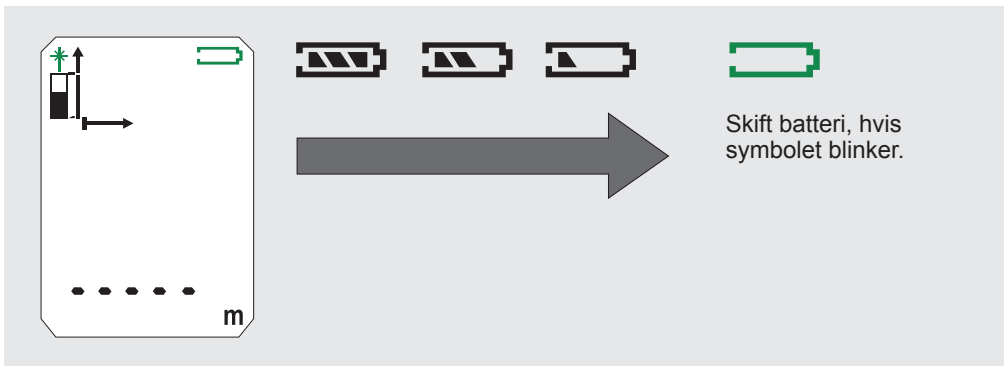

HJØRNESTIFT

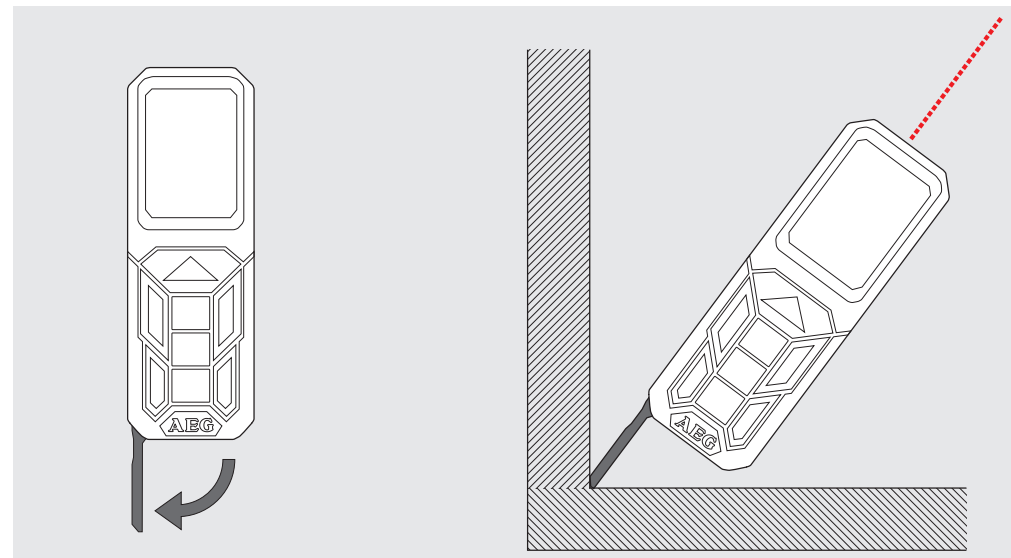

BÆLTECLIPS

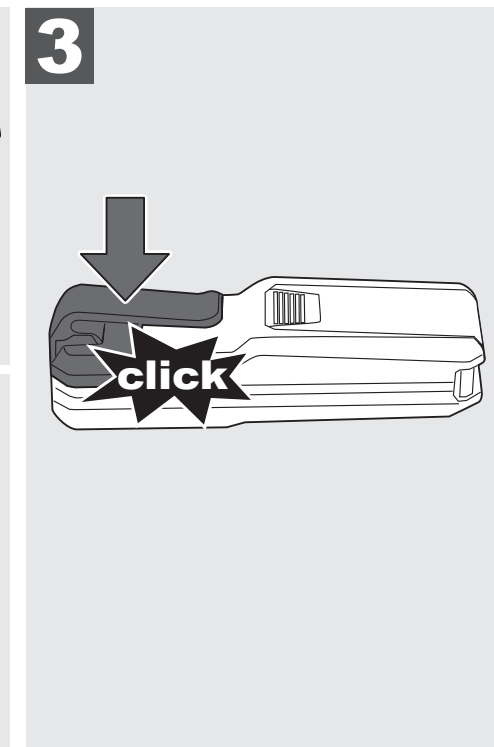
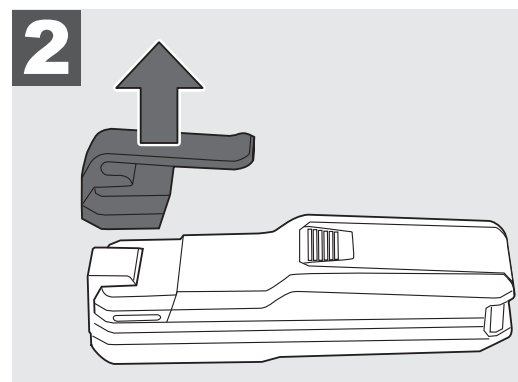
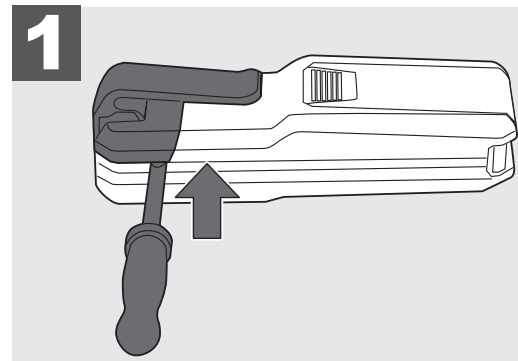

FUNKTIONSTAST, PYTHAGORAS, MÅLEREFERENCE

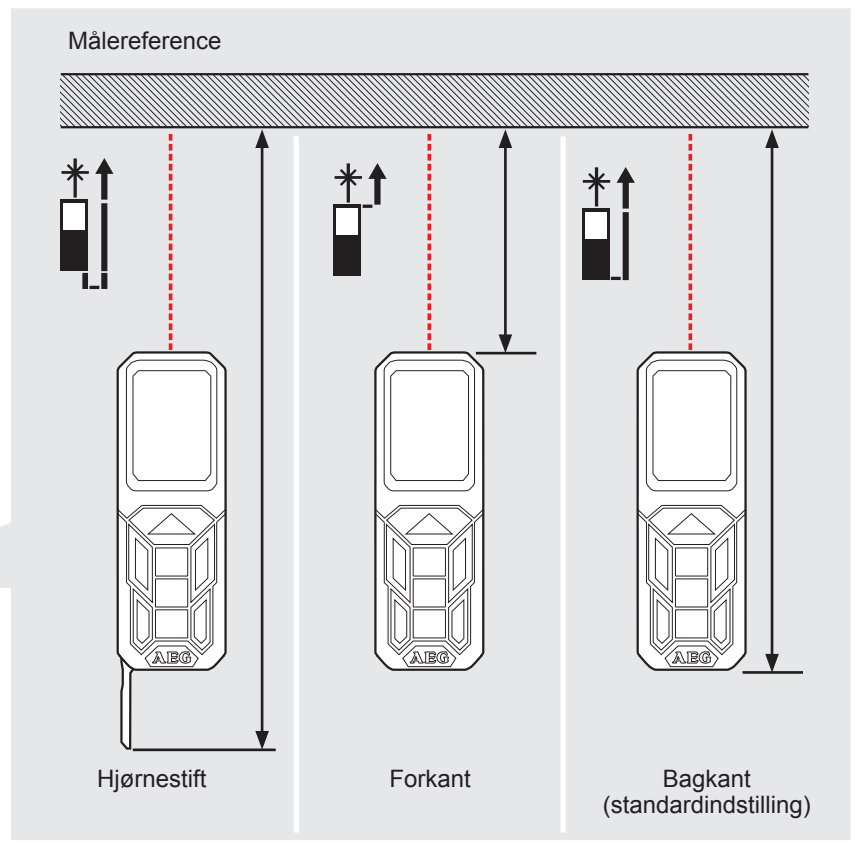
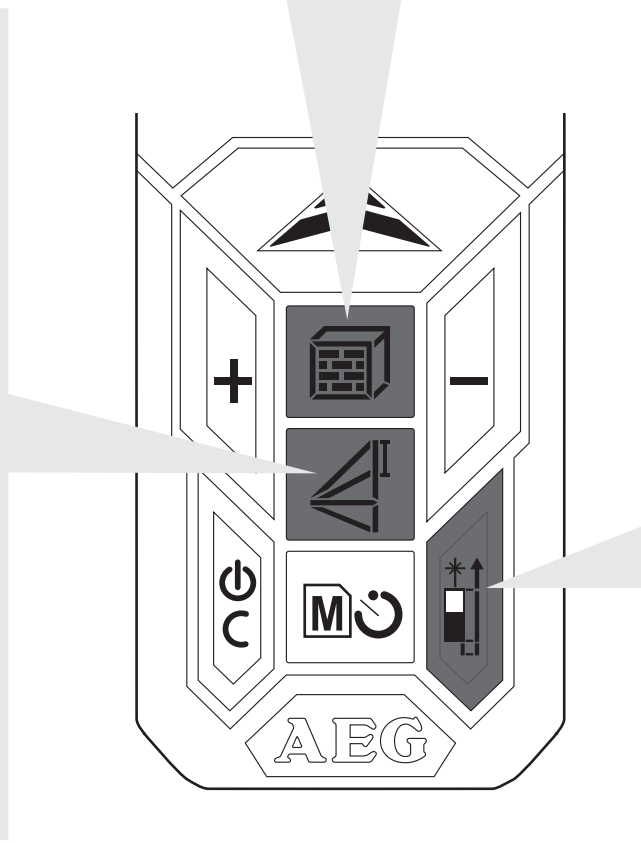
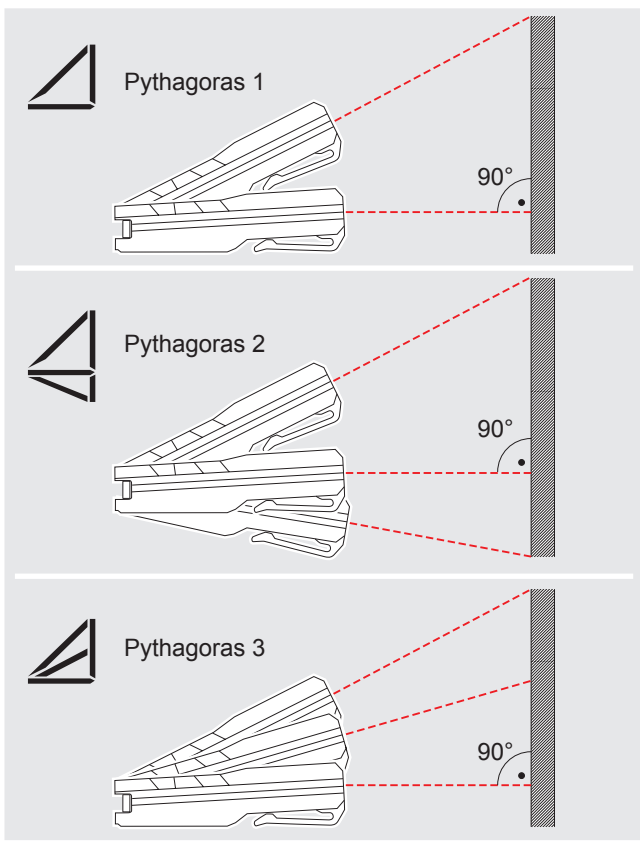
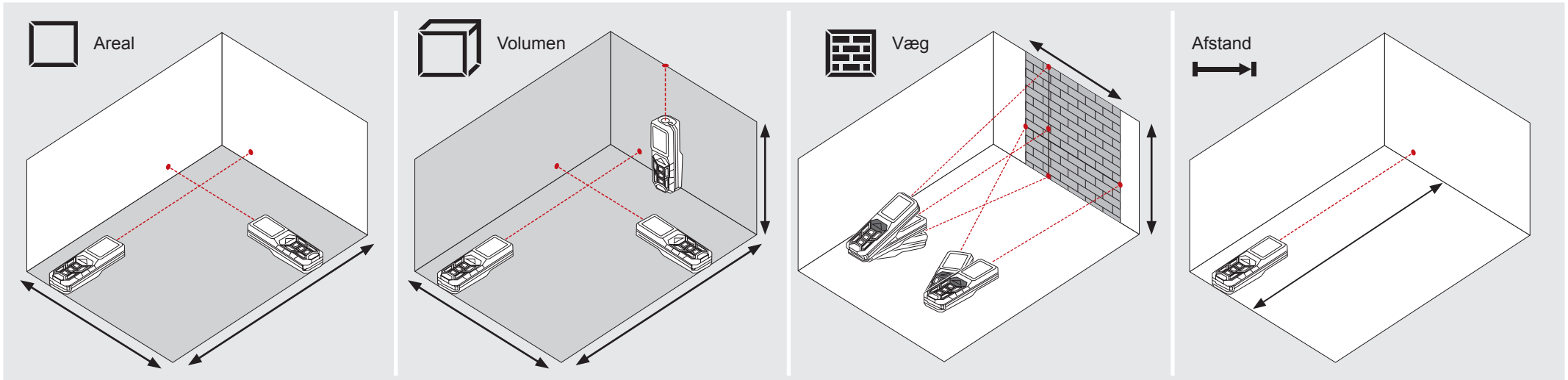

ENKELT AFSTANDSMÅLING

0

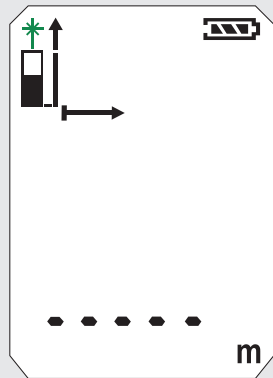

1

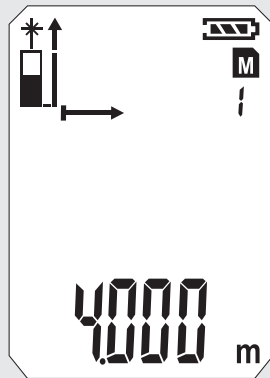
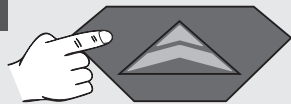

2

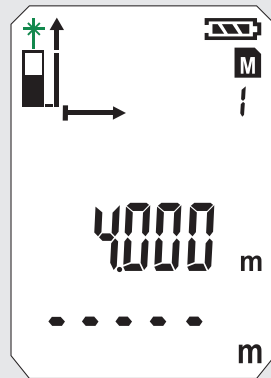
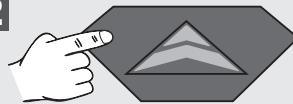

3

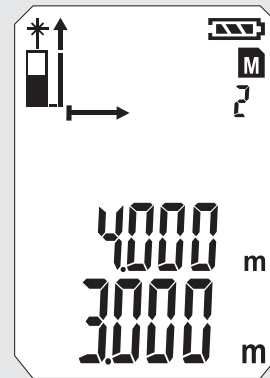
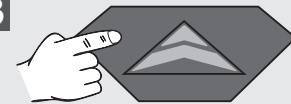

4

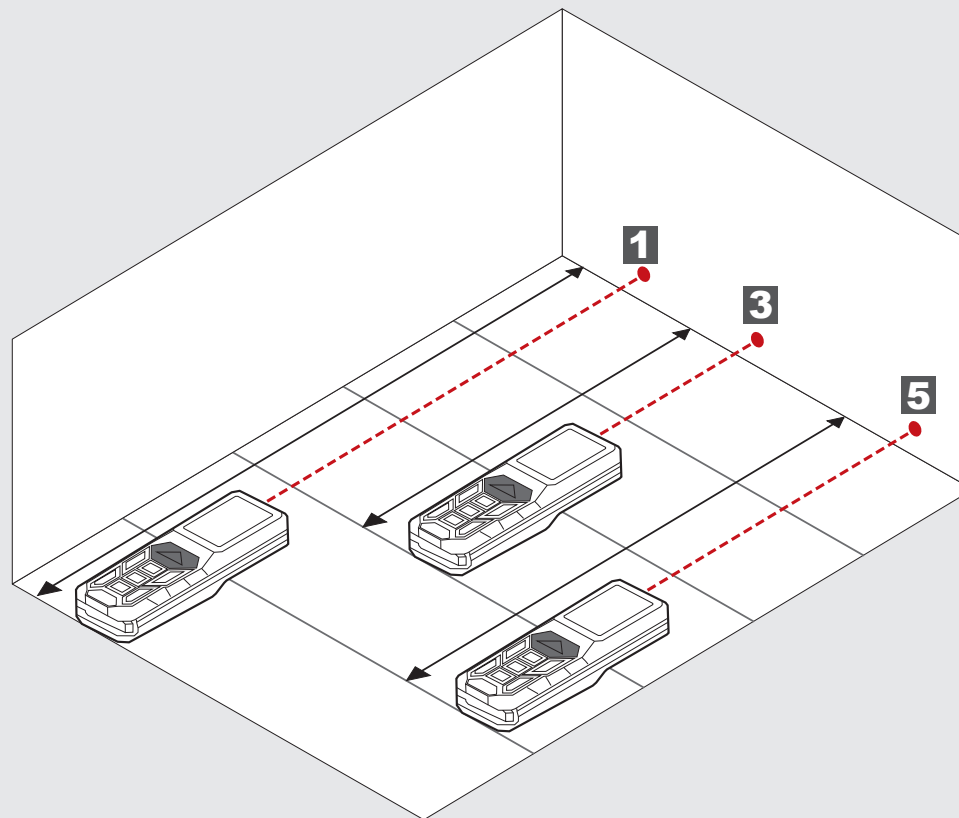
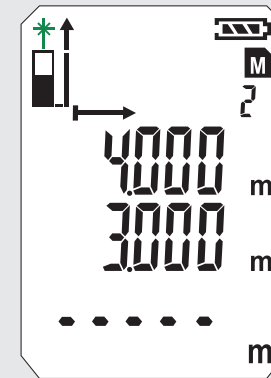
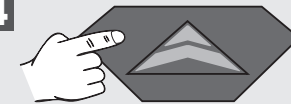

5

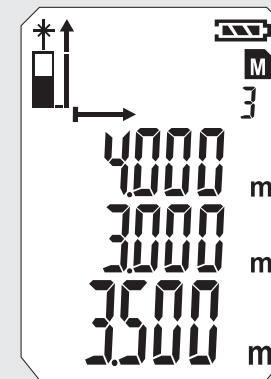
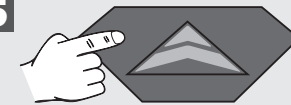

KONSTANT MÅLING / MINIMUM-MAKSIMUM MÅLING

0

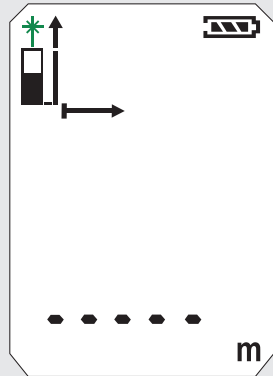

1

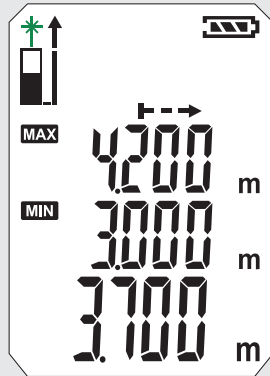
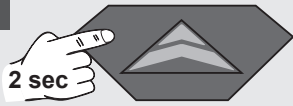

2

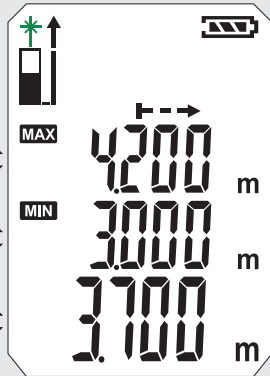

3

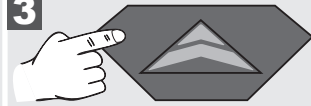

Stop
MIN / MAX

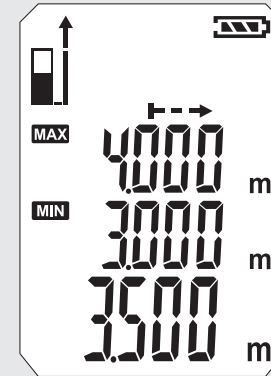

4

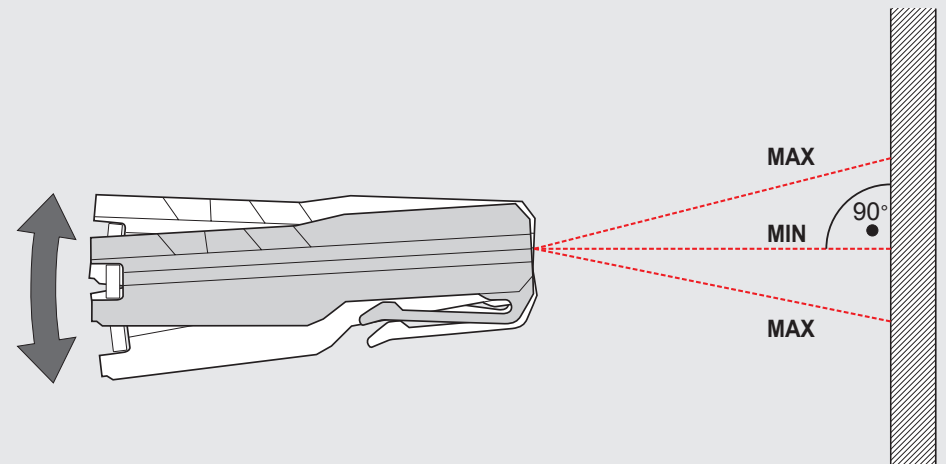
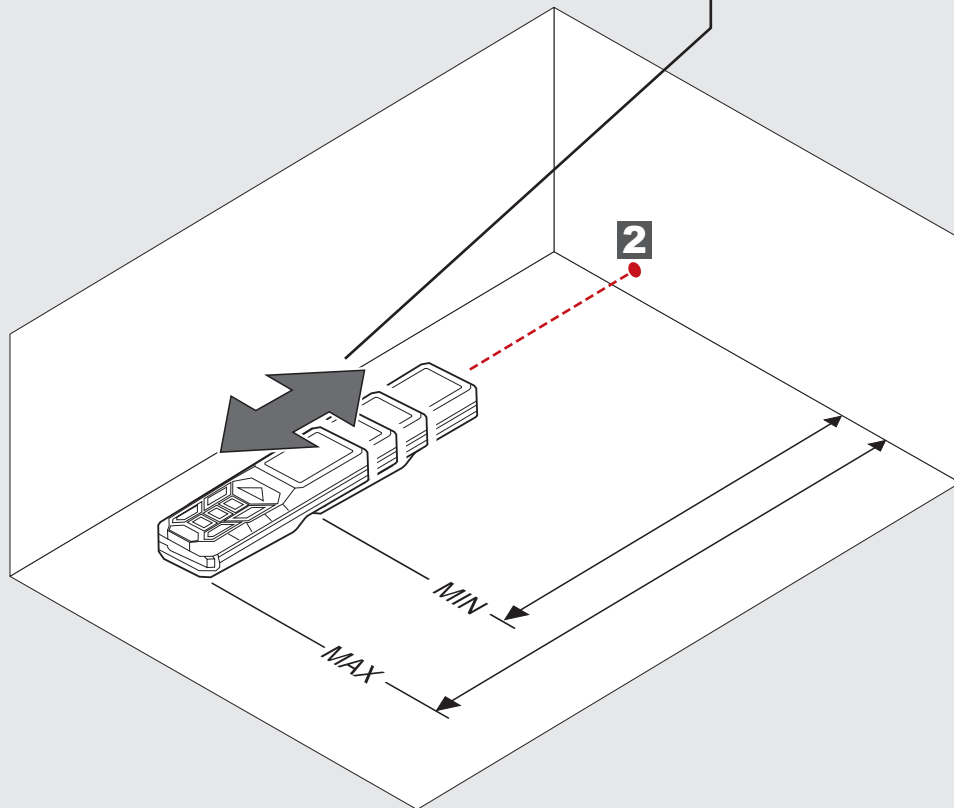
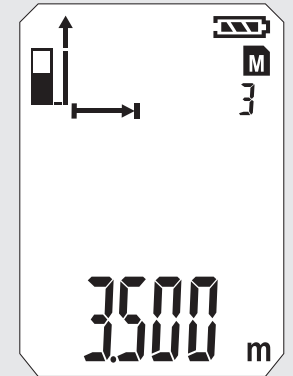

0

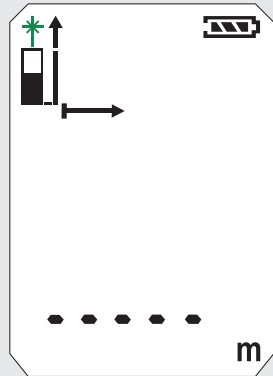

1

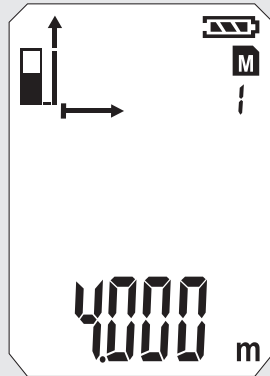
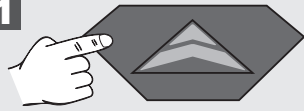

2

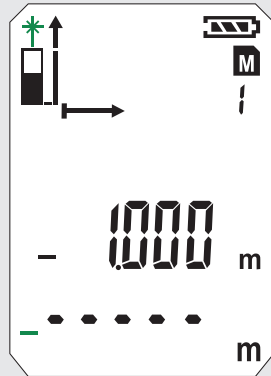
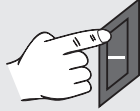

3

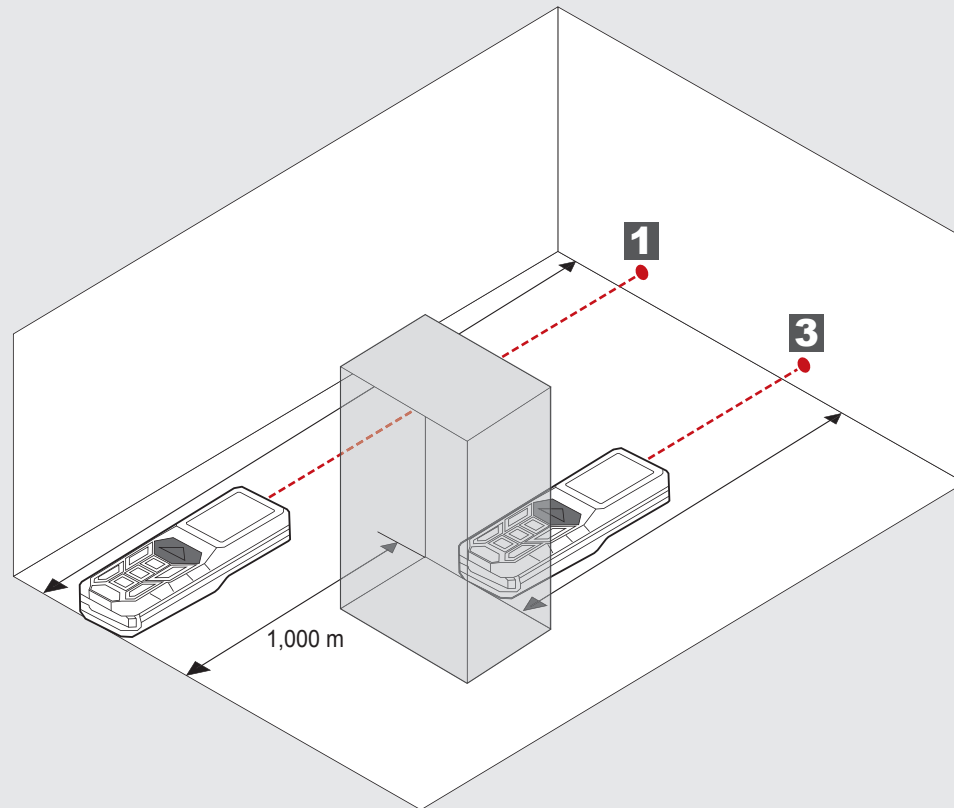
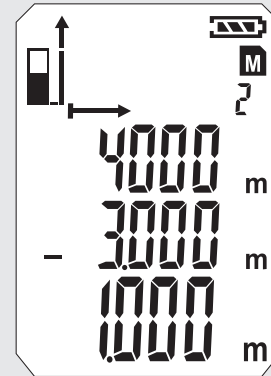
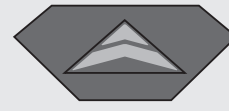

AREALMÅLING

0



1

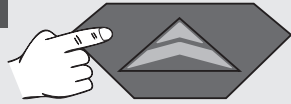

2

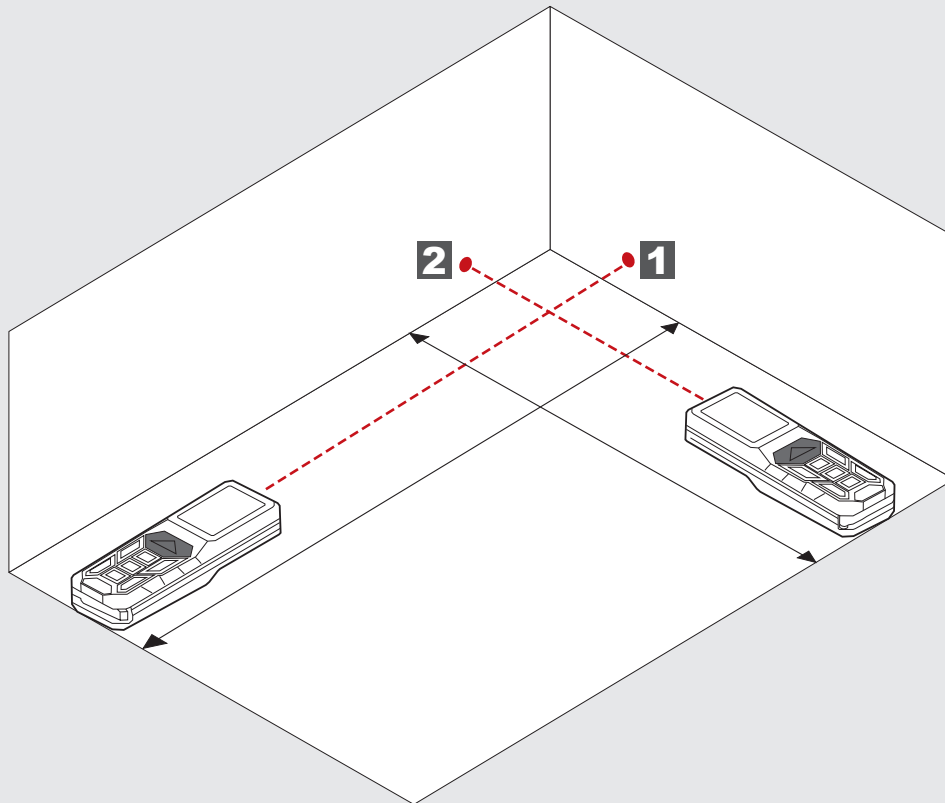
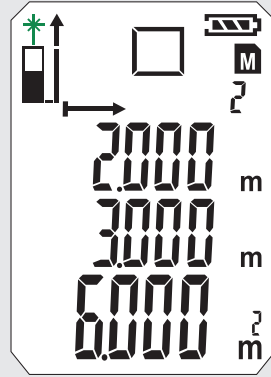
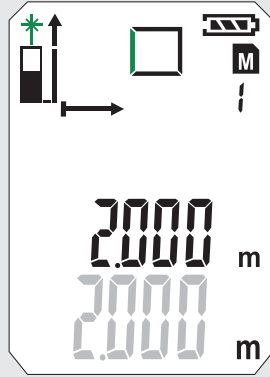
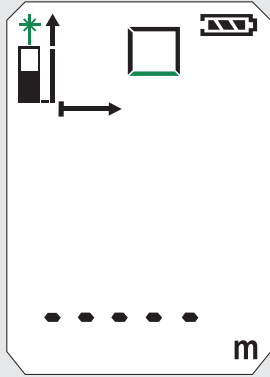
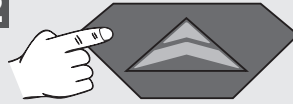

VOLUMENMÅLING

0



1

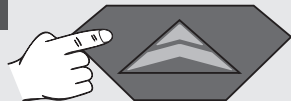

2

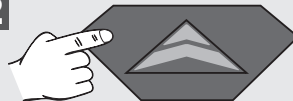

3

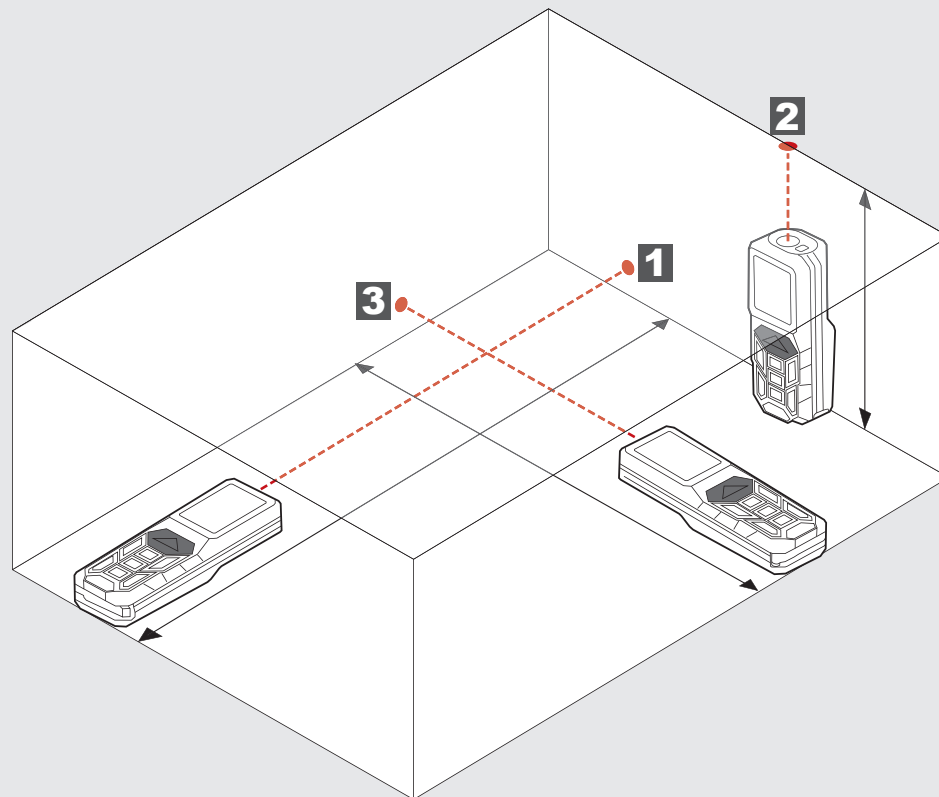
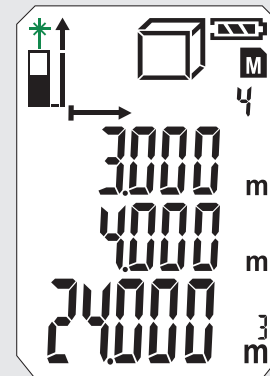
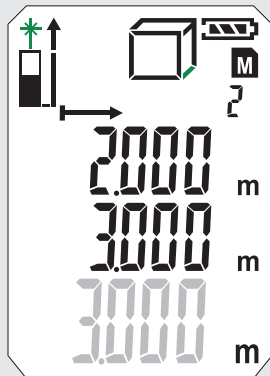
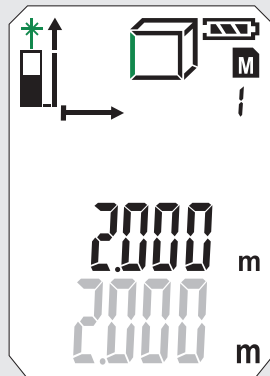
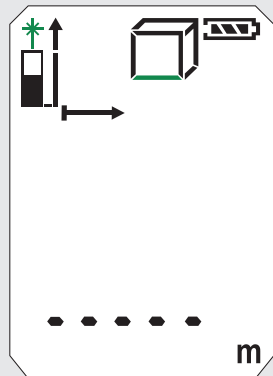
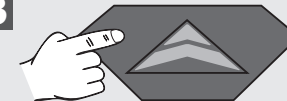

INDIREKTE MÅLING (PYTHAGORAS 1)

0



1

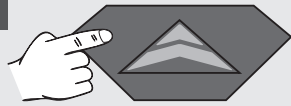

2

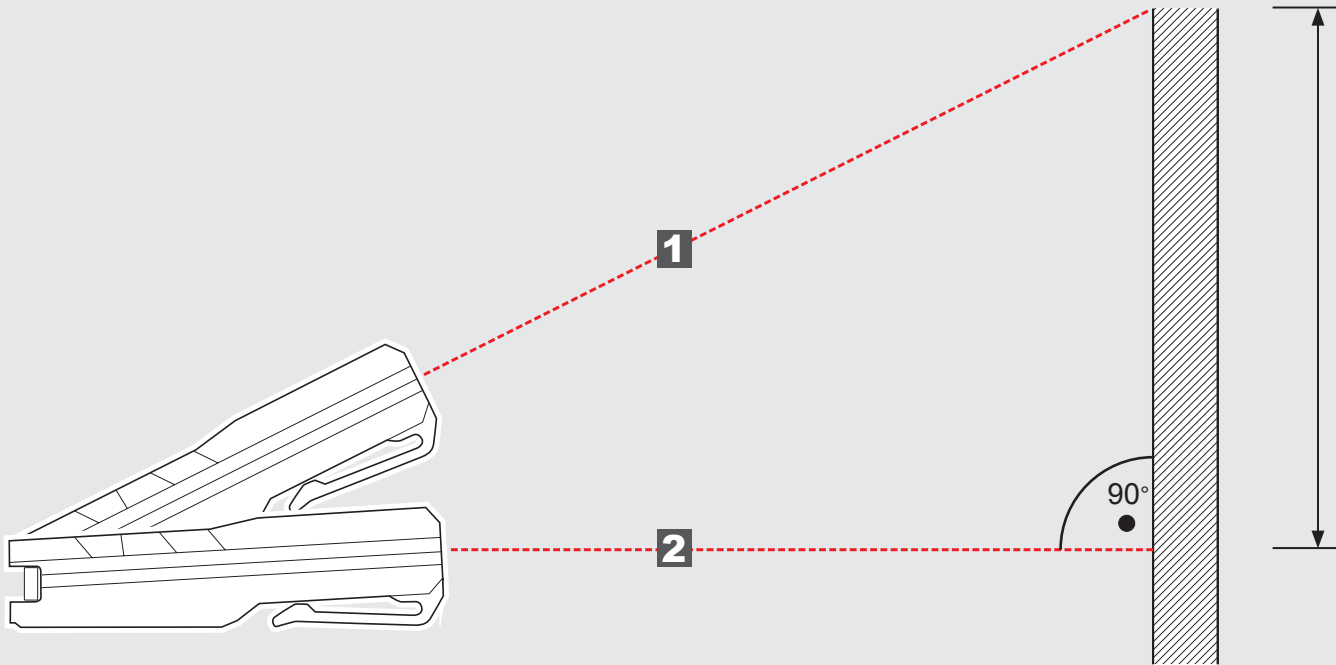
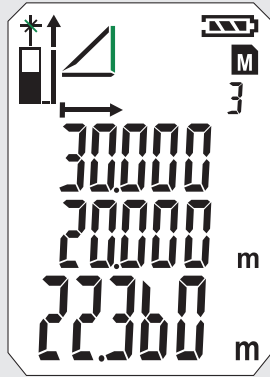
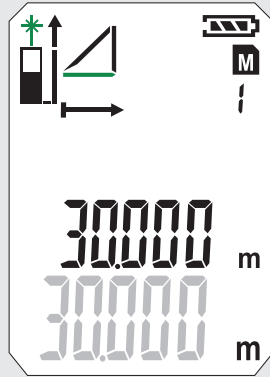
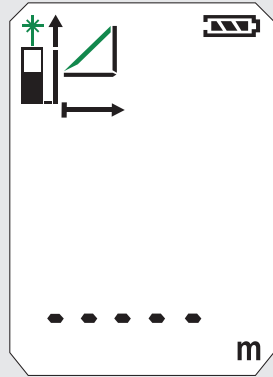
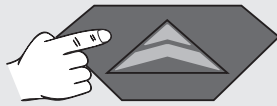

INDIREKTE MÅLING (PYTHAGORAS 2)

0



1

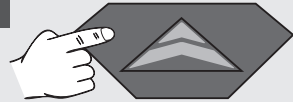

2

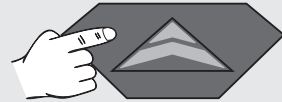

3

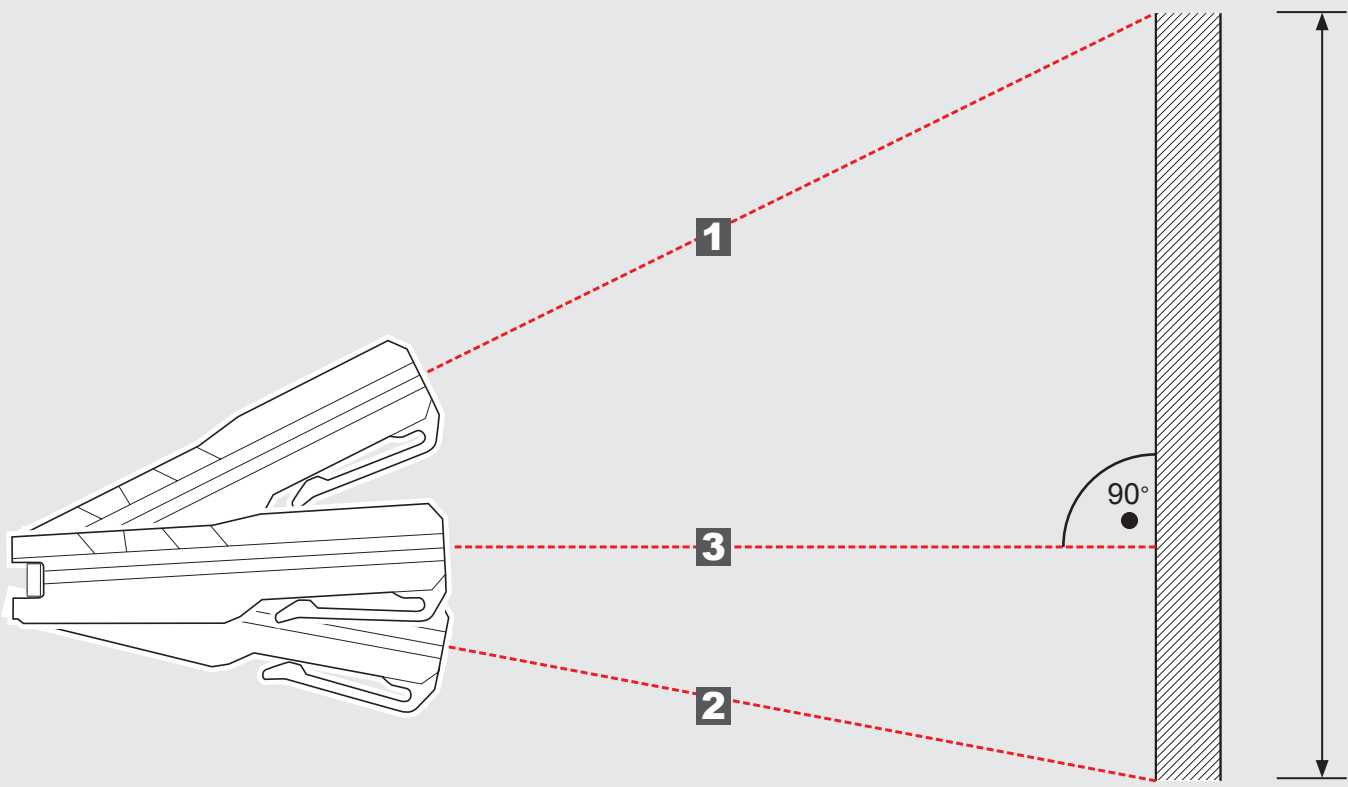
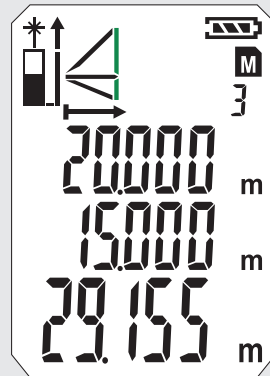
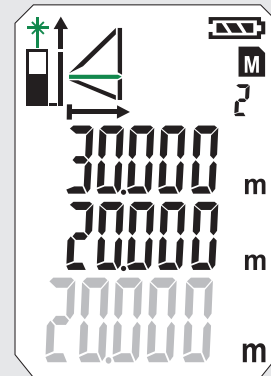
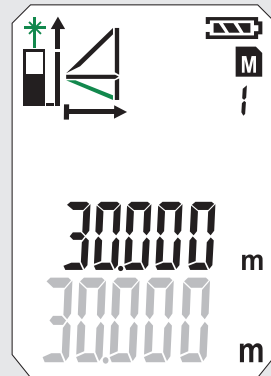
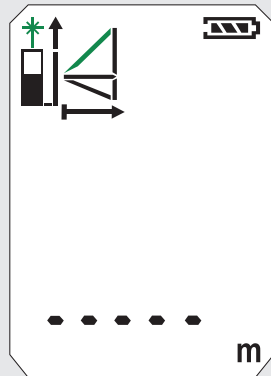
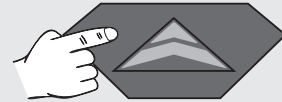

INDIREKTE MÅLING (PYTHAGORAS 3)

1

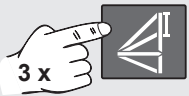

2

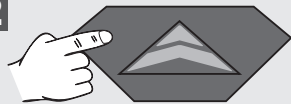



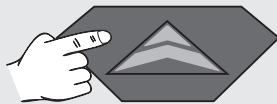

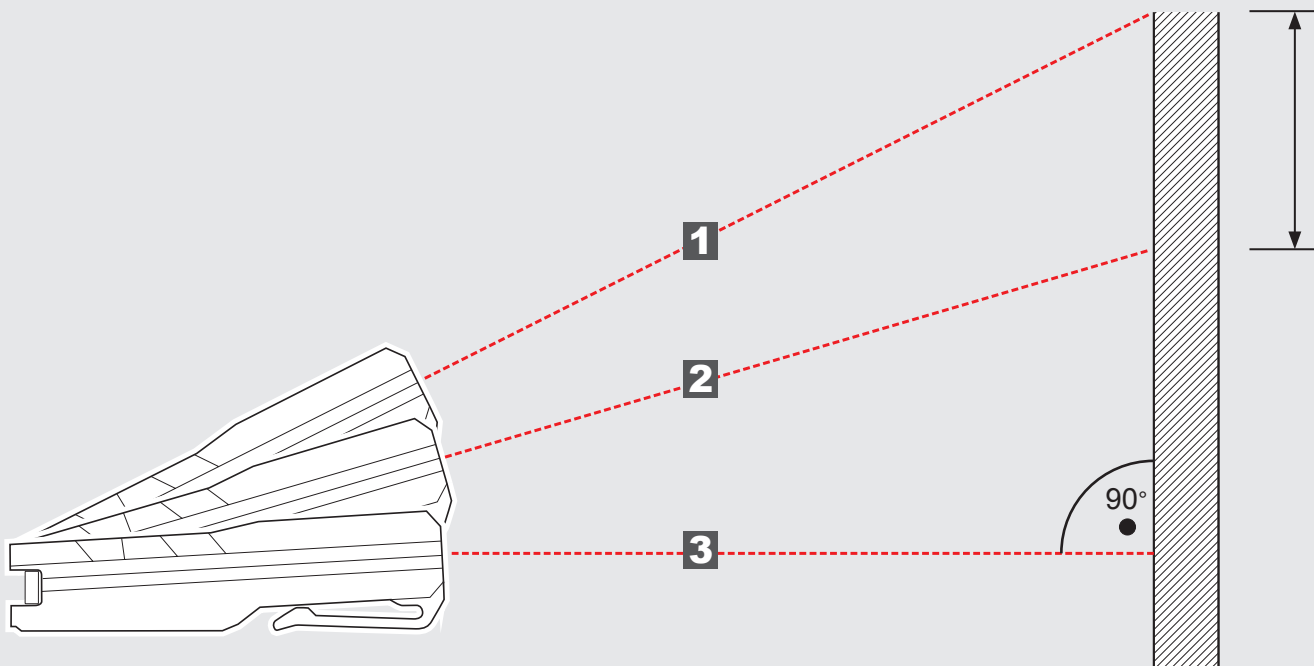
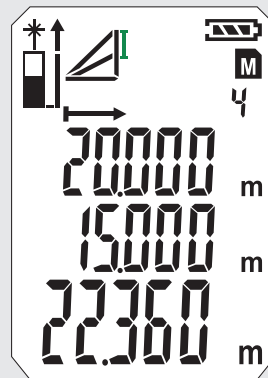
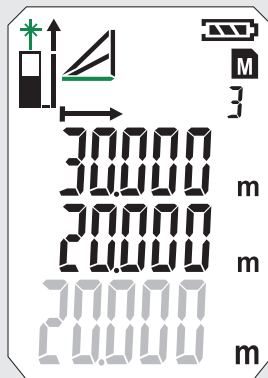
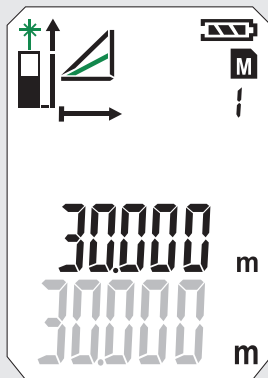
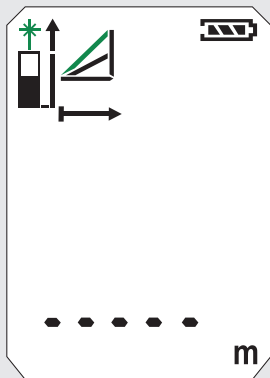
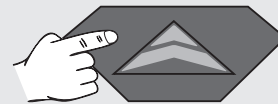

3





4



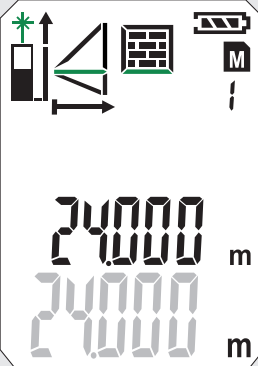
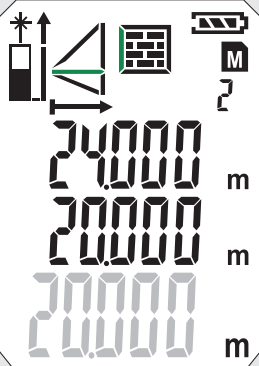
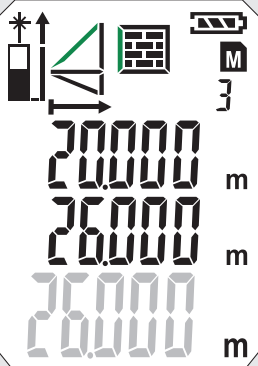
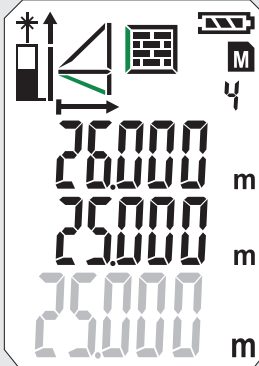

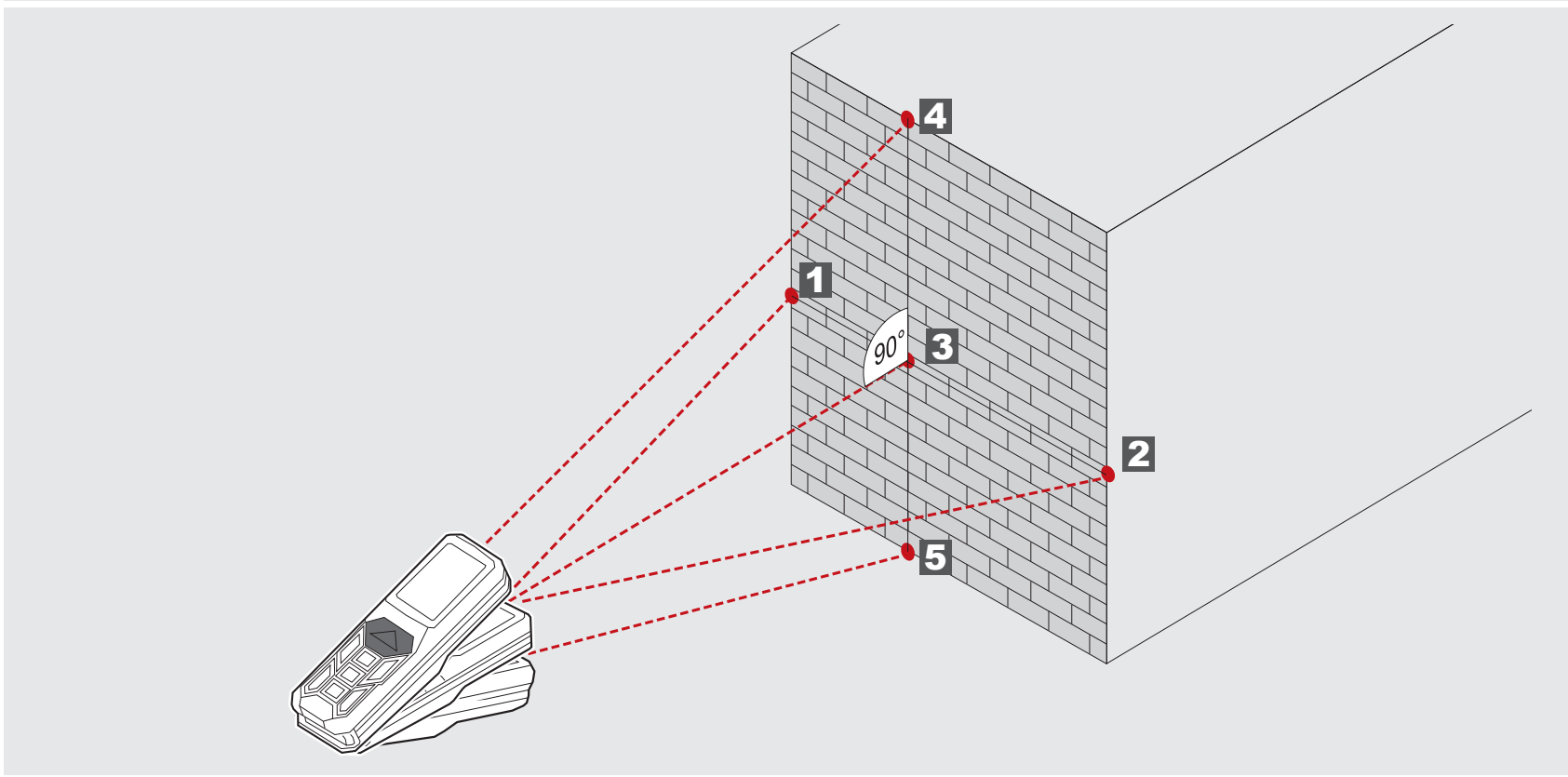



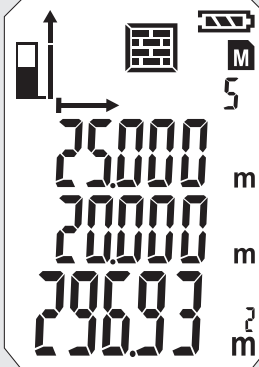



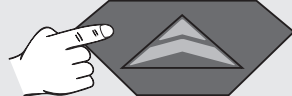
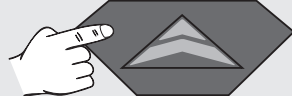

MÅLING AF VÆGAREAL (SCENARIO 1)

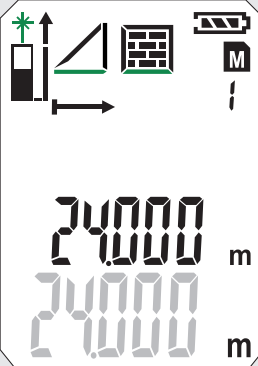
0 	1 	2 	3 	4 
				

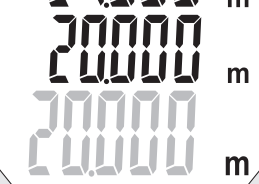

5 

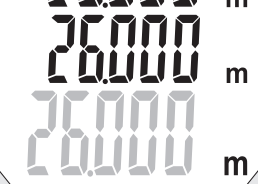
MÅLING AF VÆGAREAL (SCENARIO 2)

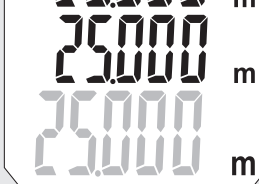
0 	1 	2 	3 	4 
 	 	 	 	 

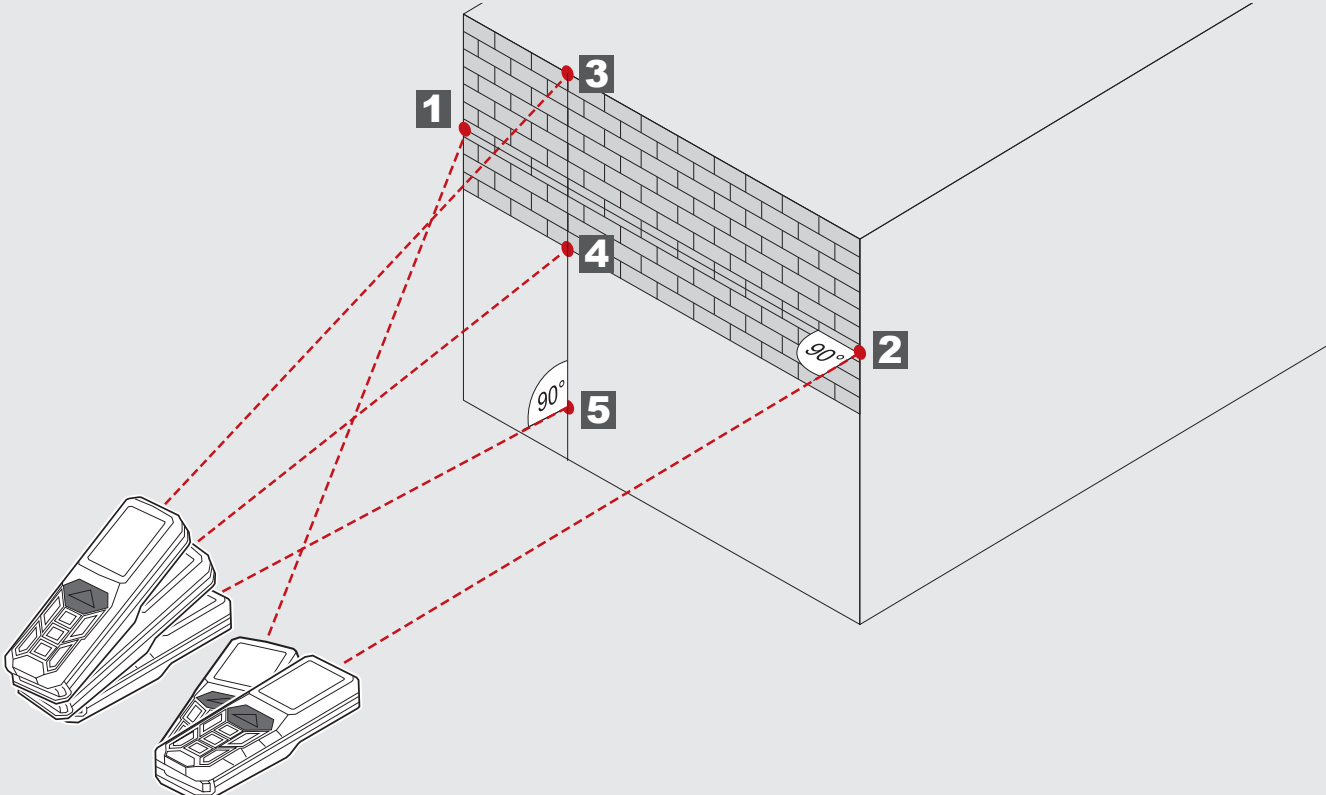

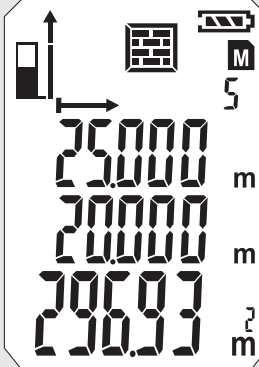

5



TIMER

Med timeren kan målingen startes forsinket, sådan at der f.eks. kan placeres en komponent i målestrålen.

Tryk på tasten 

- Symbolet vises
- Timeren kan indstilles på mellem 3 og 15 sek., når der trykkes på tasten .

Tryk på tasten 

- Sekunderne tælles ned, indtil målingen starter.
- Ved 0 starter målingen.

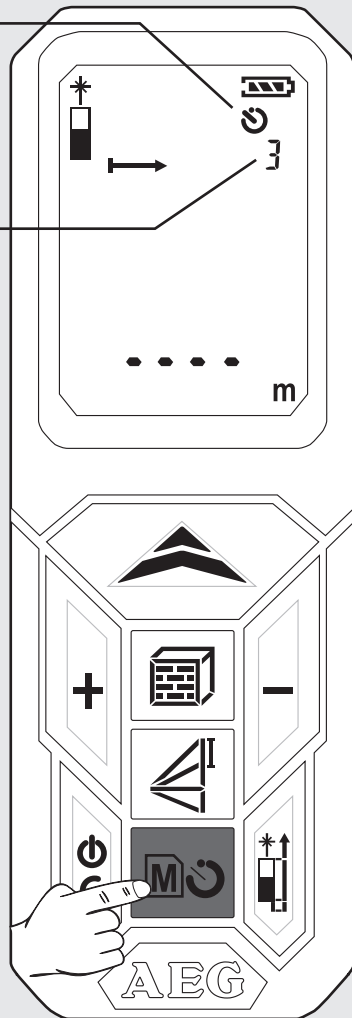

HUKOMMELSE

Måleværdierne gemmes konstant og automatisk i hukommelsen.

De gemte værdier kan hentes med tasten .

Tryk på tasten  i 2 sek.

- Symbol og hukommelsesnummer vises.
- Tilhørende målestørrelse vises.
- Den gemte værdi vises i hovedlinjen.
- Navigér med +/-tasterne

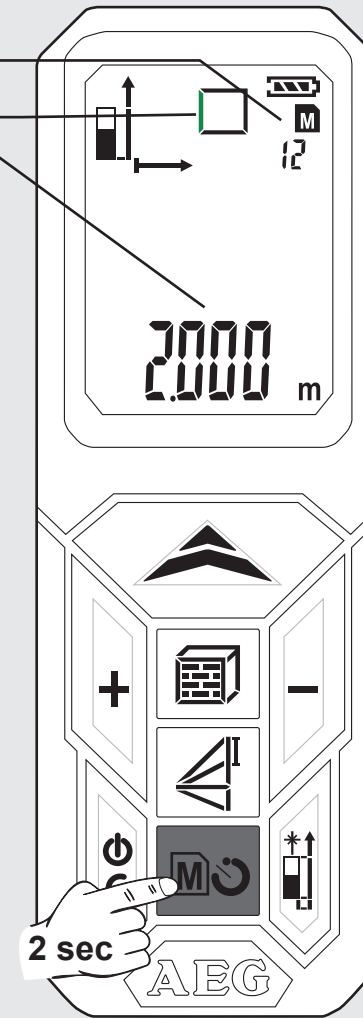



GRUNDLÆGGENDE FUNKTIONSMÅDE VIST MED ET EKSEMPEL PÅ EN AREALMÅLING (1)

1 Tænd

Tryk på tasten .
⚠ OBS! Laserstrålen er tændt!
 Peg ikke på personer!

2 Vælg målreference

Standardindstilling når instrumentet er tændt: bagkant
 Tryk 1x -> Hjørnestift
 Tryk 2x -> Forkant
 Tryk 3x -> Bagkant

3 Vælg funktion

Når instrumentet er tændt, står det altid på afstandsmåling.
 Tryk 1x - arealmåling

4 Mål længde

Justér instrumentet og tryk på tasten 

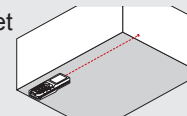

5 Mål bredde

Justér instrumentet og tryk på tasten 

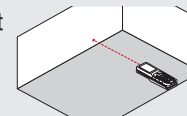

Lasersymbolet blinker (grøn blinken er vist).

Symbolet vises

- Symbolet vises
 - Målestørrelse blinker (grøn blinken er vist)

- Måleværdien vises kort i hovedlinjen.
 - Måleværdien hopper efter 1 sek. op i linjen oven over.
 - Måleværdien gemmes i hukommelsen under et fortløbende nummer.
 Den anden målestørrelse blinker. Instrumentet er parat til at måle den anden værdi.

- Måleværdien vises kort i hovedlinjen.
 - Måleværdien hopper efter 1 sek. op i linjen oven over.
 Måleværdien gemmes i hukommelse under et fortløbende nummer.
 - Resultatet vises i hovedlinjen og gemmes i hukommelsen under et fortløbende nummer.

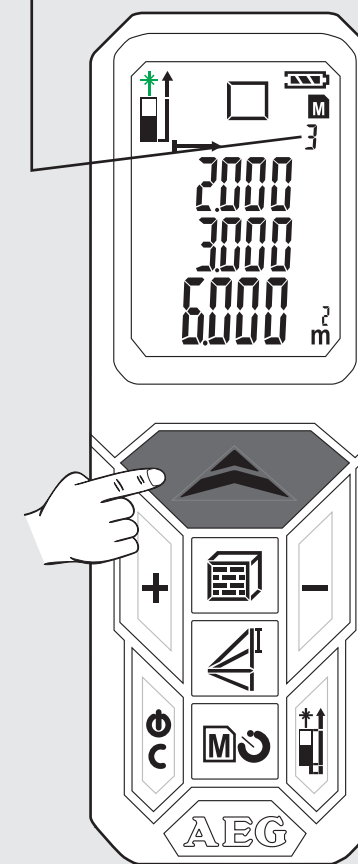
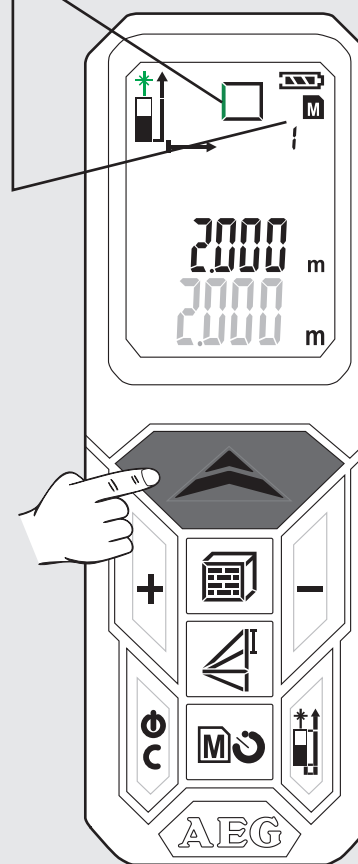
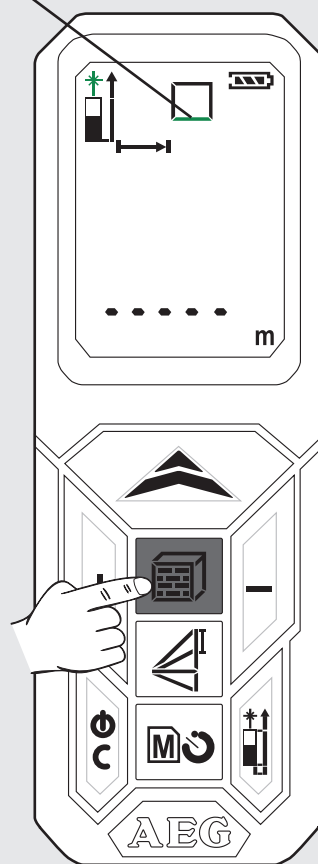
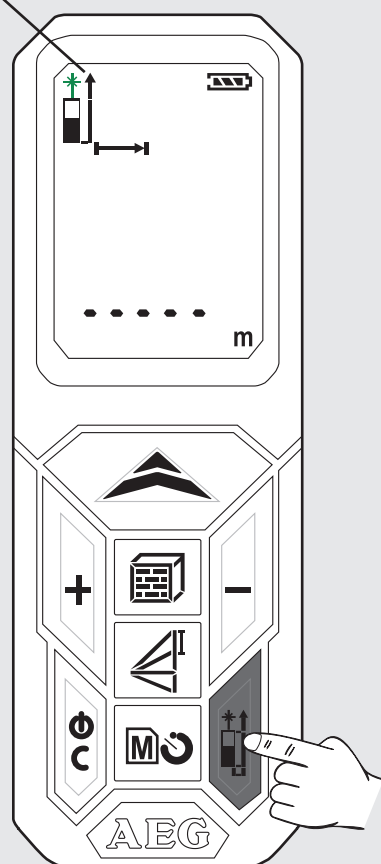
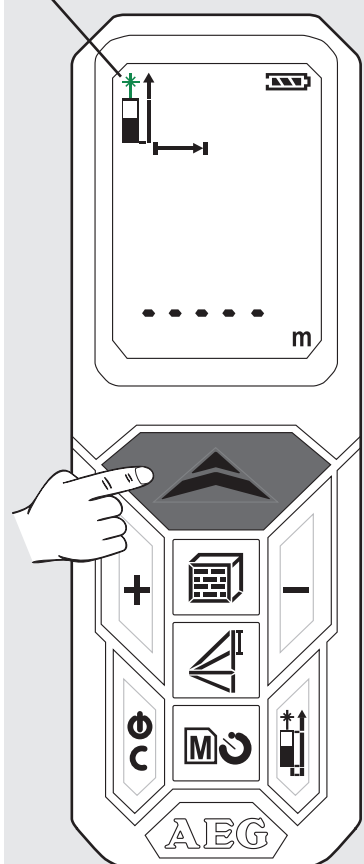

GRUNDLÆGGENDE FUNKTIONSMÅDE VIST MED ET EKSEMPEL PÅ EN AREALMÅLING (2)

6 Hent gemte værdier

Tryk på tasten  i 2 sek.
Tryk på tasten + eller -

7 Forlad hukommelsen

Tryk på tasten 

8 Sluk

Tryk på tasten  i 2 sek.
(Hukommelsen skal forlades forinden).

- De gemte værdier vises i hovedlinjen.

- Det tilhørende symbol vises og målestørrelsen blinker (grøn blinken er vist).

- Instrumentet slukker.

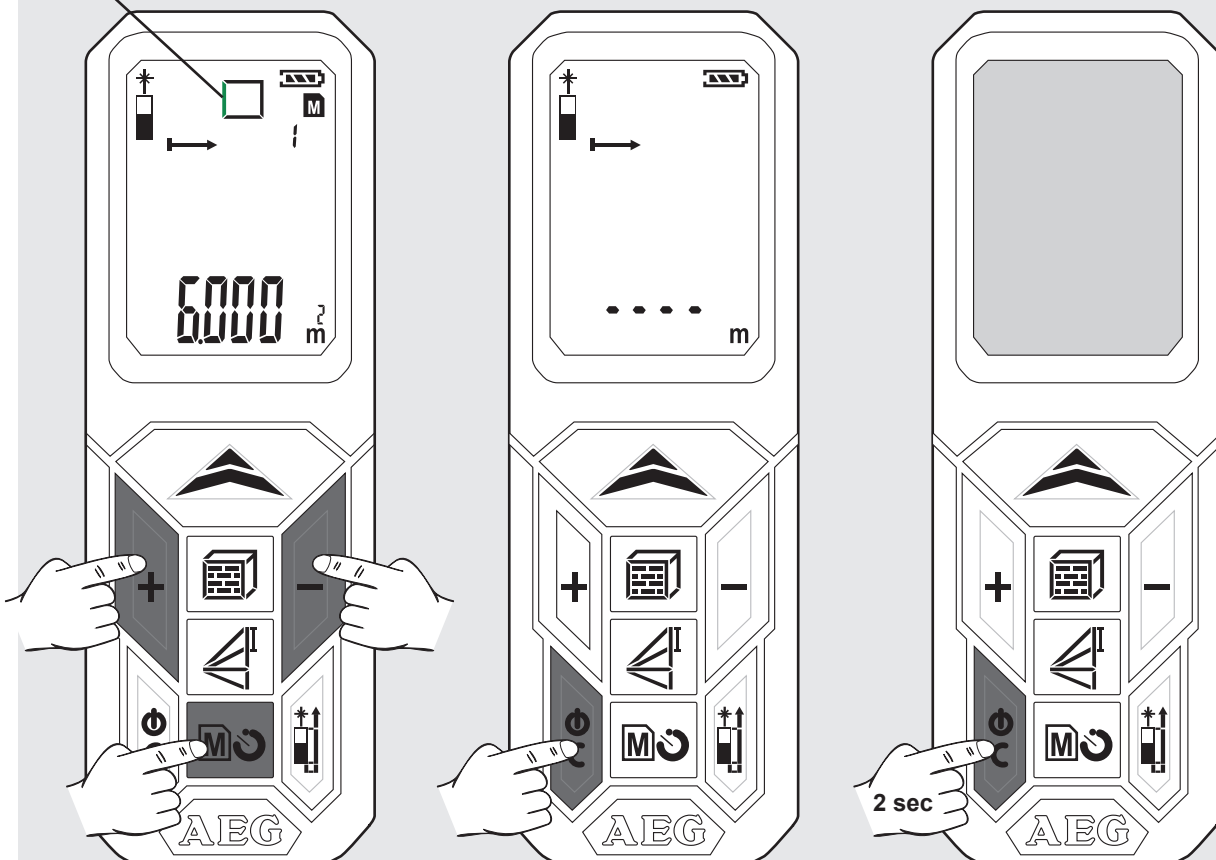

- Trykkes der ikke på en tast i 3 minutter, slukker instrumentet automatisk.



INNHOOLD

Viktige sikkerhetsinstruksjoner	1
Tekniske data.....	2
Formålmessig bruk	2
Feilkode tabell	2
Oversikt	3
Skifte batteri.....	4
Hjørnestift	4
Belteholder	4
Funksjonstast, Pythagoras, Måle nivå.....	5
Enkel lengdemåling	6
Kontinuerlig måling / Minimum-Maksimum Måling	7
Addisjons- / Subtraksjonsmåling	8
Overflatemåling	9
Volummåling	10
Indirekte måling (Pythagoras 1).....	11
Indirekte måling (Pythagoras 2).....	12
Indirekte måling (Pythagoras 3).....	13
Veggflate måling (Scenario 1)	14
Veggflate måling (Scenario 2)	15
Tidsinnstiller.....	16
Minne.....	16
Grunnleggende bruksbeskrivelse av eksempel til en overflatemåling (1).....	17
Grunnleggende bruksbeskrivelse av eksempel til en overflatemåling (2).....	18

VIKTIGE SIKKERHETSINSTRUKSER

  Ikke bruk produktet før du har studert sikkerhetsinstruksene og brukerhåndboken på vedlagte CD.

Laserklassifisering

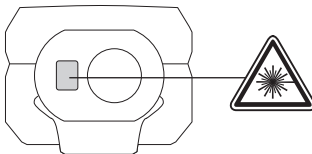

ADVARSEL:

Dette er et Class 2 laserprodukt i henhold til IEC 60825-1:2007.



Påskrift

Før første ibruktaking skal det klistres over prestasjonsetiketten med opplysninger på engelsk språk. Til dette er det vedlagt et klebemerke med opplysninger på deres språk.

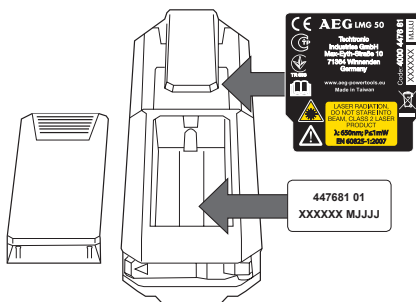

OBS:

Unngå direkte øye kontakt. Laserstrålen kan gi blitzer i øynene, noe som kan føre til en midlertidig blinding.

Unngå å inn i laserstrålen og å rette den unødig mot andre personer.

Ikke pek mot andre personer.

Advarsel:

Ikke bruk laser apparatet i nærheten av barn. Ikke tillat at barn benytter laser-apparatet.

OBS! En reflekterende overflate kan sende laserstrålen tilbake til bruker eller reflektere andre personen.

Hold kroppsdeler i sikker avstand til deler som beveger seg.

Gjennomfør regelmessig kontrollmålinger. Spesielt før, under og etter viktige målinger.

Se opp for feilmålinger hvis det er feil ved instrumentet, hvis det har falt i bakken, hvis det har vært utsatt for ikke tillatte belastninger, eller hvis det har blitt ombygd.

OBS! Gjør deg kjent med betjeningselementene og den korrekte bruken av hageredskapet.

Lasermåleapparatet har et begrenset bruksområde. (Se avsnitt "Tekniske data"). Forsøk på måling utenfor det minimale og maksimale område forårsaker unøyaktigheter. Bruk ved vanskelige betingelser som for varmt, for kaldt, svært sterkt sollys, regn, snø, tåke eller andre betingelser som innskrenker sikten, kan føre til unøyaktige målinger.

Dersom lasermåleapparatet blir brakt fra en varm omgivelse til en kald omgivelse (eller omvendt), må det ventes til apparatet har tilpasset seg den nye omgivelsestemperaturen.

Lasermåleapparatet skal alltid oppbevares i rom som beskytter apparatet mot rystelse, vibrasjoner og ekstreme temperaturer.

Lasermåleapparatet skal beskyttes mot støv, væte og høy luftfuktighet. Dette kan skade de indre delene og ha innflytelse på nøyaktigheten.

Ikke bruk aggressive rensemiddel eller løsemiddel. Skal rengjøres bare med en ren myk klut.

Unngå harde slag på og fall av lasermåleapparatet.

Nøyaktigheten av apparatet burde kontrolleres dersom det har falt ned eller har vært utsatt for andre mekaniske belastninger.

Nødvendige reparasjoner på dette laser-apparatet skal kun gjøres av autorisert fagpersonale.

Ikke bruk instrumentet i eksplosjonsfarlige områder eller i aggressive miljøer.

Batteriene må bare lades opp med et ladeapparat som er levert av produsenten.

 Brukte batterier må ikke kastes i husholdningsavfallet. Vern om miljøet og send dem til oppsamlingsstasjoner som er beregnet til dette i henhold til nasjonale eller lokale forskrifter. Produktet må ikke kastes i

husholdningsavfallet. Utstyret må kasseres på forsvarlig måte i samsvar med gjeldende nasjonale forskrifter. Følg nasjonale og landsspesifikke bestemmelser.

 CE-tegn

TEKNISKE DATA

Verneklasse	IP54 (støv- og sprutevann beskyttet)
Optik	14 mm
Fokus	35 mm
Måleområde maks	50 meter (toleranse: 55m)
Måleområde minimum.	0,05 meter
Absolutt nøyaktighet @ < 10m	± 1,5 mm (maks)
Gjentakelse nøyaktighet @ < 10m	± 1,5 mm (typisk maks 2σ)
Gjentakelse nøyaktighet @ > 10m	Stigning ± 0,25 mm / meter (typisk maks 2σ)
Måletid	0,5 s
Display type	LCD (22,7 mm x 31 mm)
Strømforsyning	AAA 2x (Alkaline-batteri)
Batteriets levetid	10000 (Enkeltmåling)
Laser utgangsyttelse	0,6 mW ~ 0,95 mW (Class 2, 650nm)
Laserpunktstørrelse	25 x 30 mm @ 16 m (Maks)
Laserstråle vertikalvinkel	+1 grad
Laserstråle horisontalvinkel	±1 grad
Automatisk avslåing av apparatet	180 sekund
Automatisk avslåing av laser	30 sekund
Arbeidstemperaturområde	-10°C til +50°C
Lagertemperaturområdes	-25°C til +70°C
Vekt uten batteri	80 g

FORMÅLSMESSIG BRUK

Lasermåleapparatet er egnet for måling av avstander og hellinger.
Dette apparatet må kun brukes til de oppgitte formål.

FEILKODE TABELL

Kode	Beskrivelse	Løsning
Err01	Utenfor måleområdet	Gjennomfør målinger i planlagt område.
Err02	Reflektert signal er for svakt	Velg en bedre overflate.
Err03	Utenfor visningsområde (maks verdi: 99.999) f.eks. Er resultat av flate eller volum utenfor visningsområde	Kontroller om verdiene og trinnene er korrekt.
Err04	Feil i Pythagorasberegningen	Kontroller om verdiene og trinnene er korrekt.
Err05	Batteri er svakt	Sett inn nye batterier
Err06	Utenfor arbeidstemperaturområde	Foreta målinger i fastsatt arbeidstemperaturområde.
Err07	Lyset i omgivelsen er for sterkt	Skyggelegg måleområdet

Pythagoras
Høydeforskjell

Måle nivå

Lengdemåling

Minimum / Maksimum for kontinuerlig måling

Addisjon / Subtraksjon

PÅ / MÅLING

- ▶ På
- ▶ Måling
- ▶ Kontinuerlig måling (trykk i 2 sekund)
Minimum / Maks funksjon

ADDISJON

- ▶ Addere verdi
- ▶ Navigere i minne

OVERFLATE / VOLUM

- ▶ Overflate (trykk 1x)
- ▶ Volum (trykk 2x)
- ▶ Indirekte overflatemåling (trykk 3x / 4x)

SLÅ PÅ

- ▶ På
- ▶ Av (trykk i 2 sekund)
- ▶ Tilbakesette

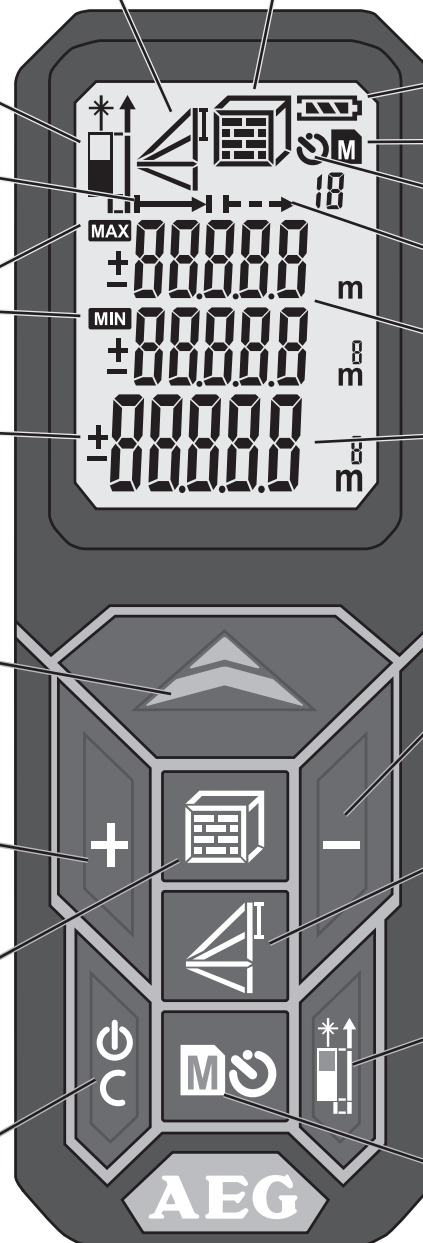

Flate / volum
Indirekt overflatemåling

Batteristatus

Minne

Tidsinnstiller

Kontinuerlig måling

Mellomverdier

Total verdi

SUBTRAKSJON

- ▶ Subtrahere verdi
- ▶ Navigere i minne

PYTHAGORAS

- ▶ Pythagoras 1 (trykk 1x)
- ▶ Pythagoras 2 (trykk 2x)
- ▶ Pythagoras 3 (trykk 3x)

SKIFT MÅLE NIVÅ

- ▶ Foran
- ▶ Bak
- ▶ Hjørnestift

MINNE

- ▶ Tidsinnstiller 3-15 sek (trykk 1x)
- ▶ Minne 1-20 (trykk 1x 2 sekund)
- ▶ Bruk +/- tastene for å navigere i minne

SKIFTE BATTERI

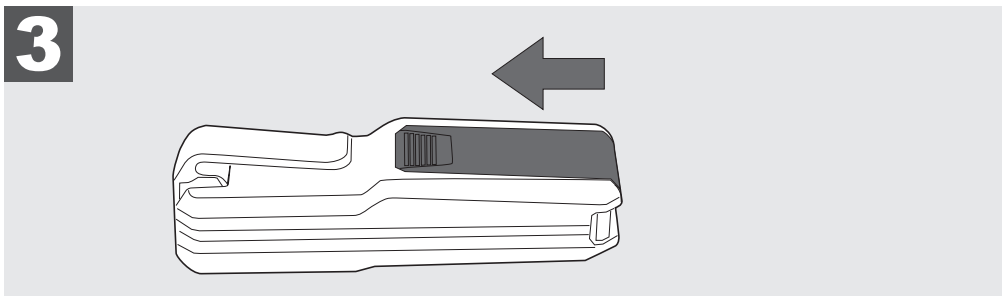
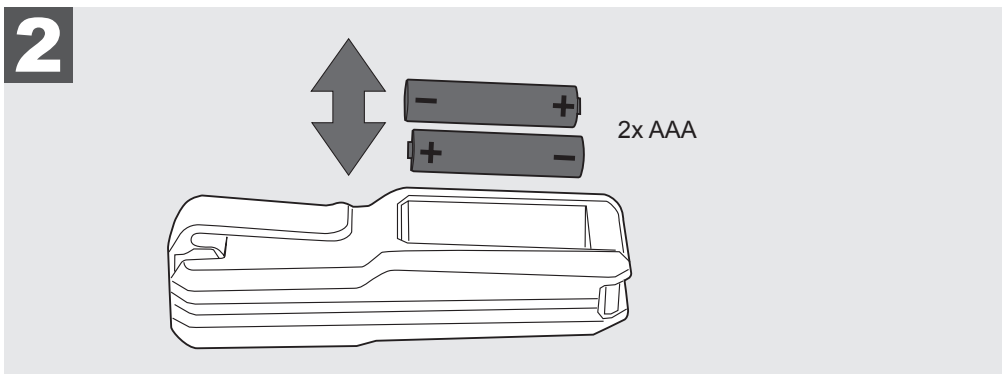
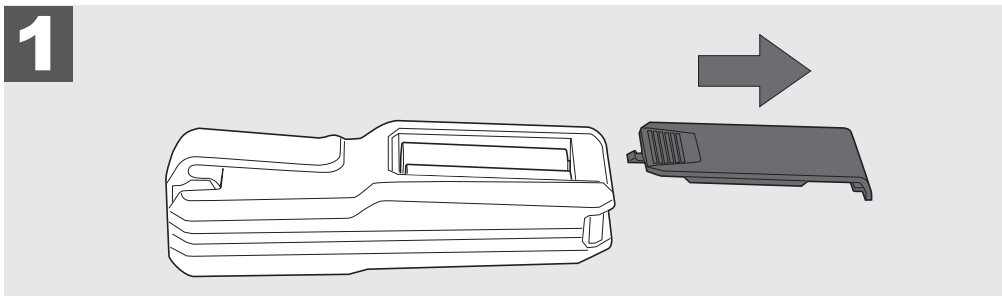
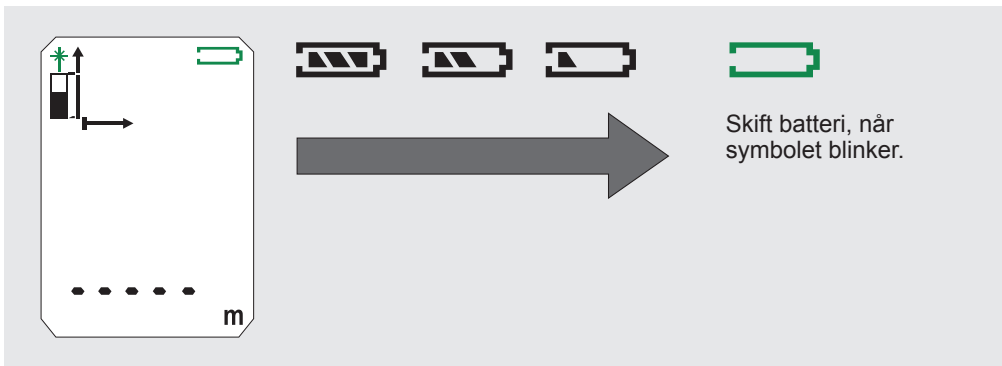

HJØRNESTIFT

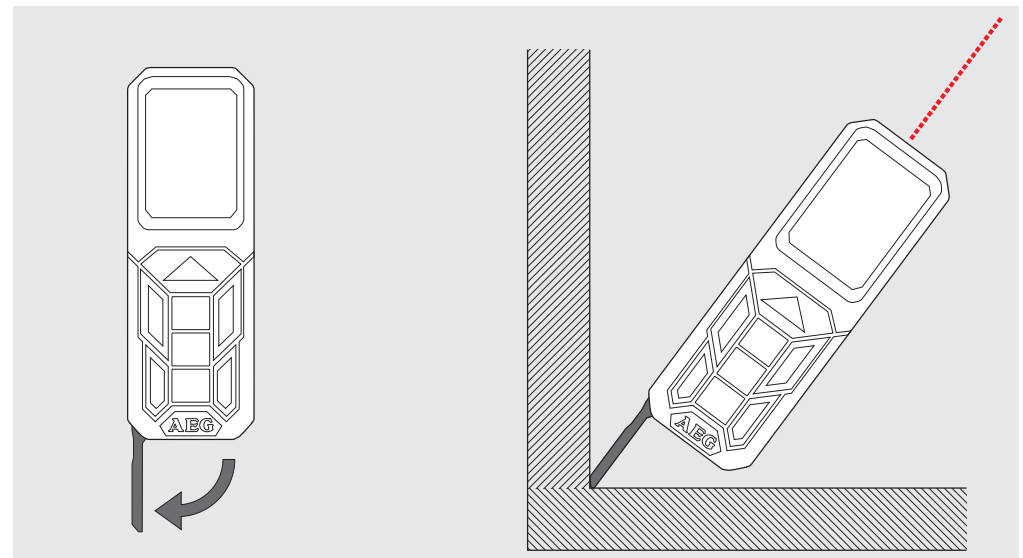

BELTEHOLDER

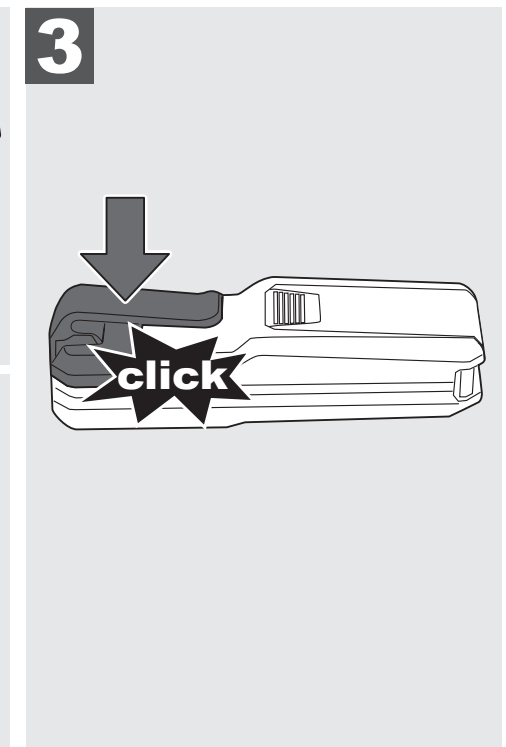
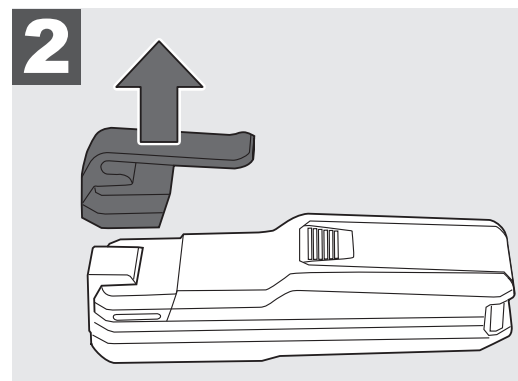
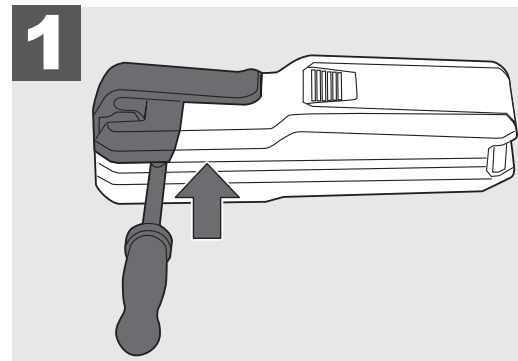

FUNKSJONSTAST, PYTHAGORAS, MÅLE NIVÅ

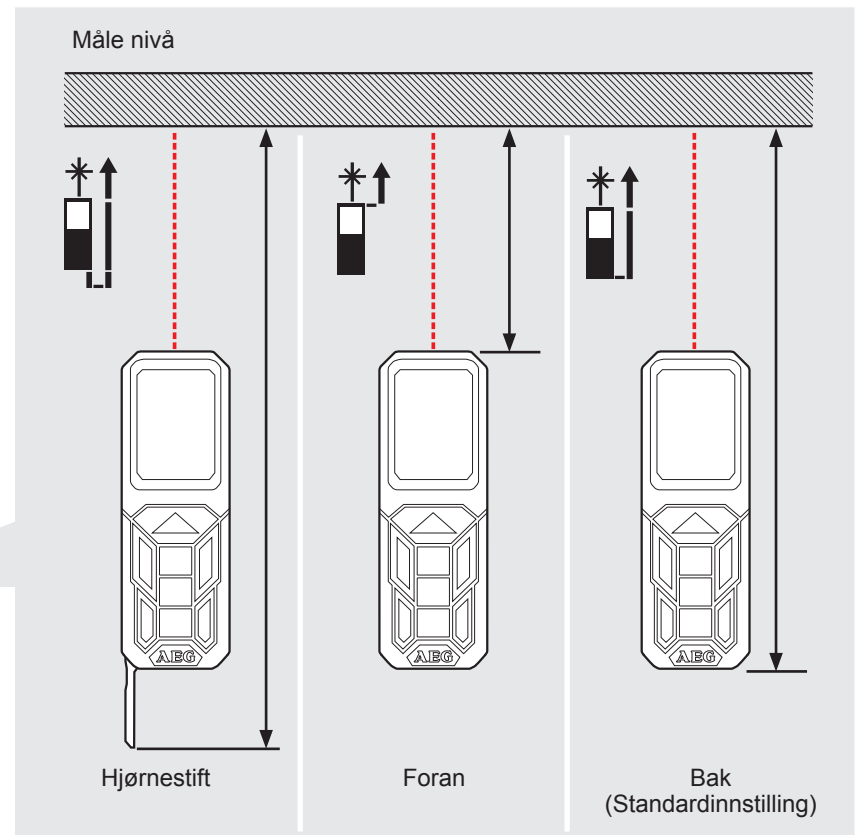
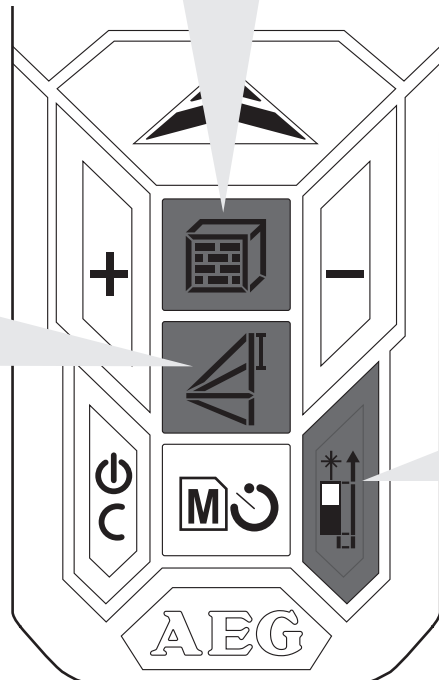
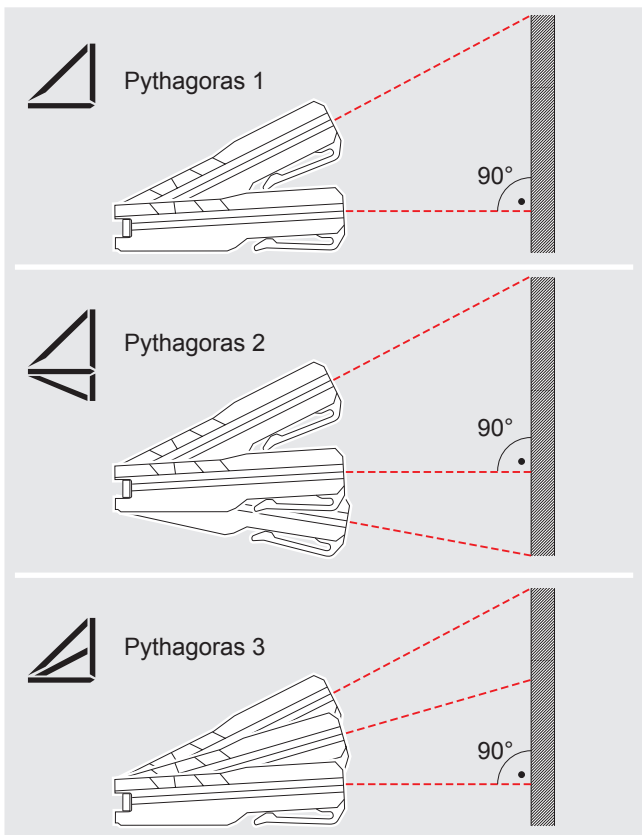
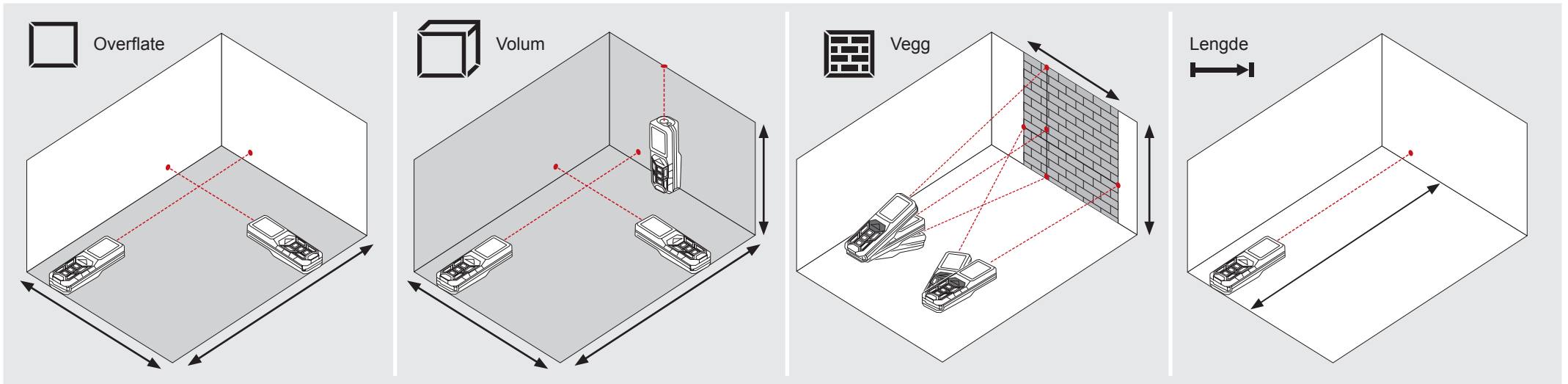

ENKEL LENGDEMÅLING

0

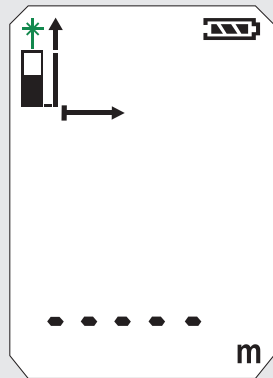

1

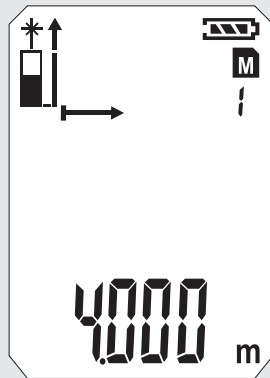
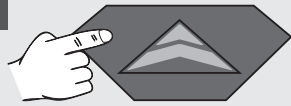

2

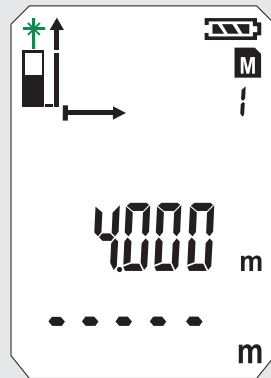
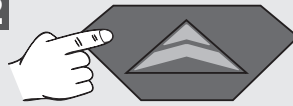

3

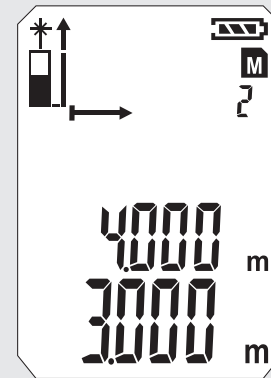
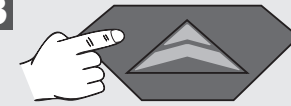

4

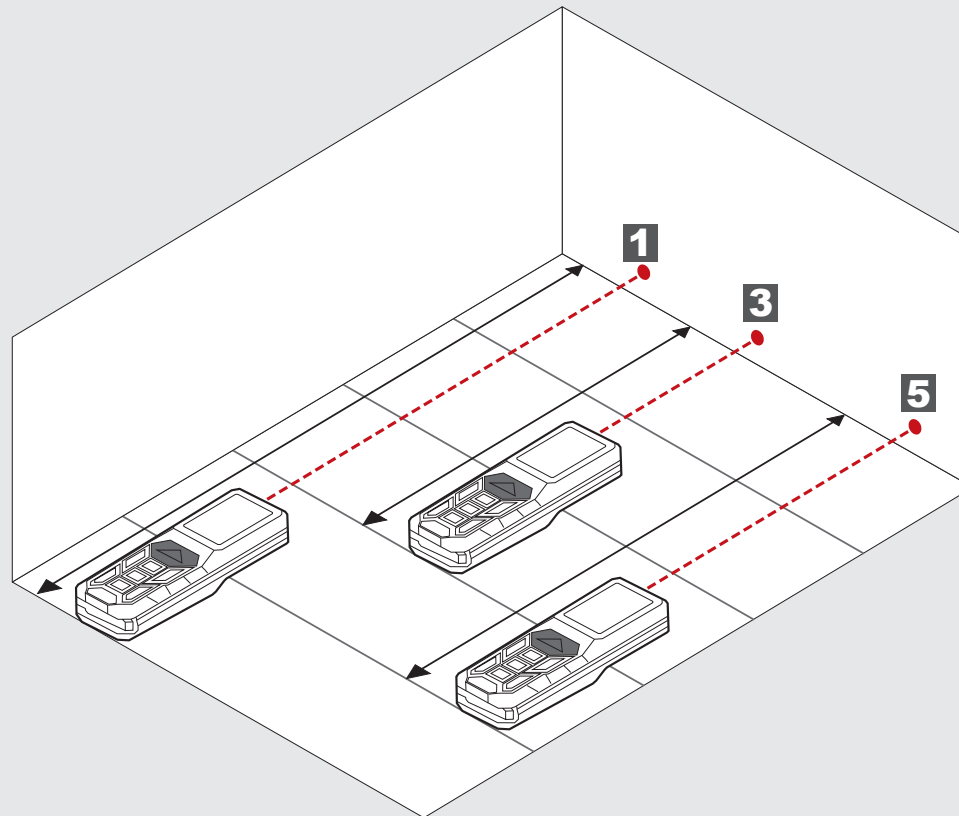
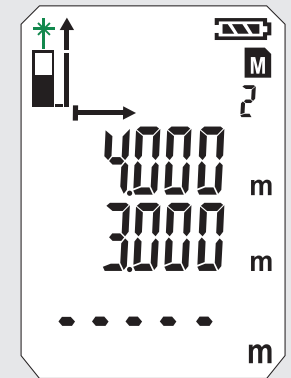
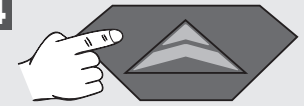

5

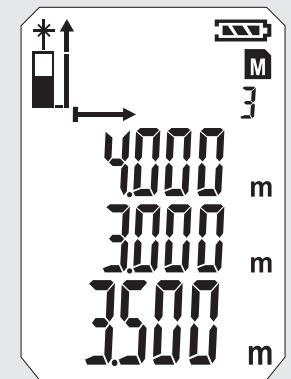
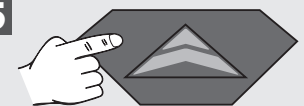

KONTINUERLIG MÅLING / MINIMUM-MAKSIMUM MÅLING

0

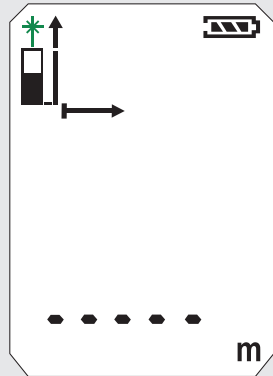

1

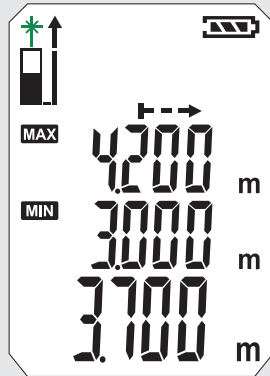
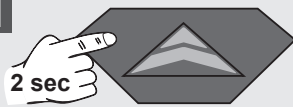

2

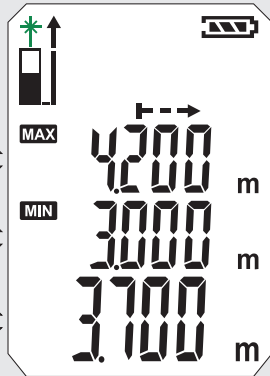

3

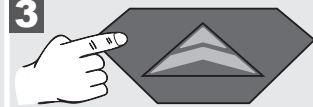

Stop
MIN / MAX

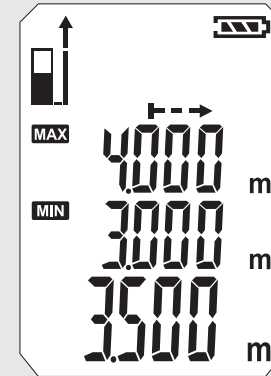

4

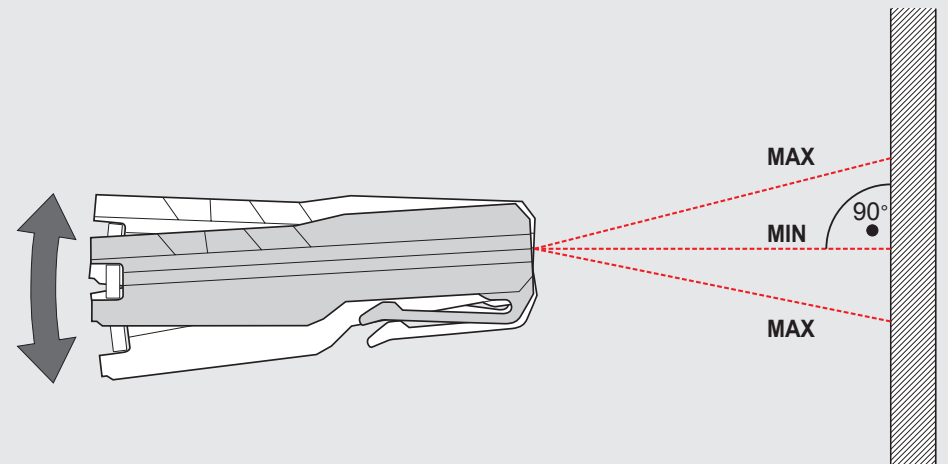
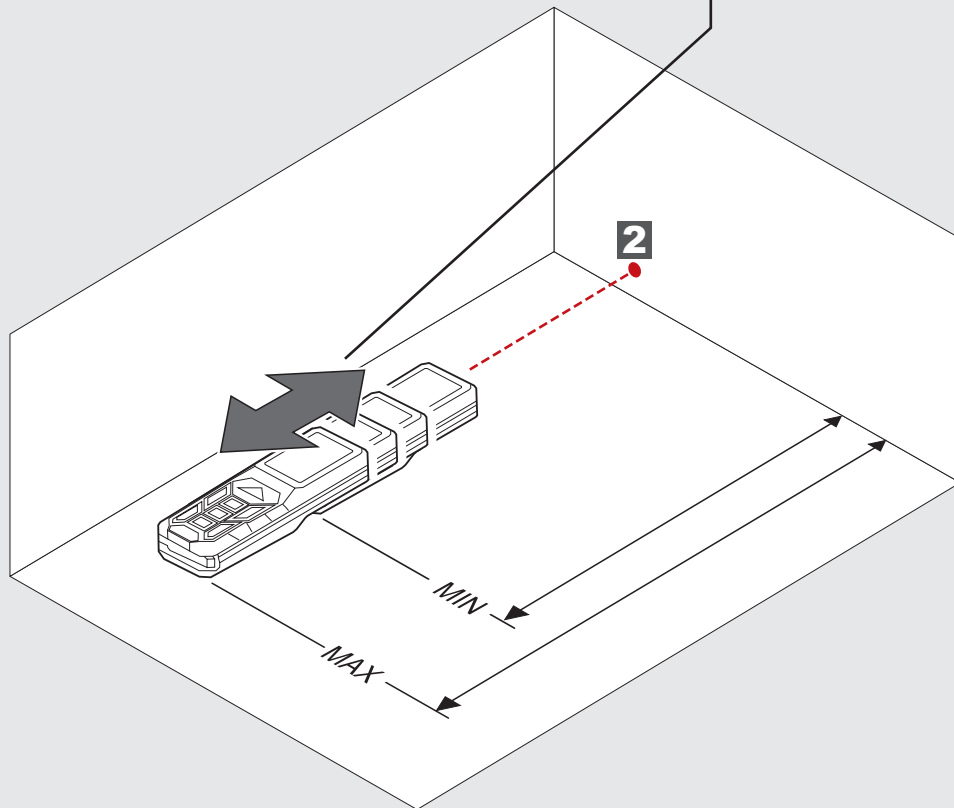
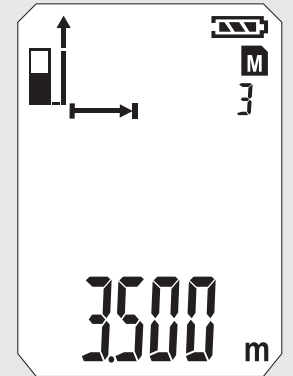
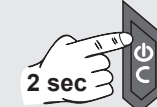

0

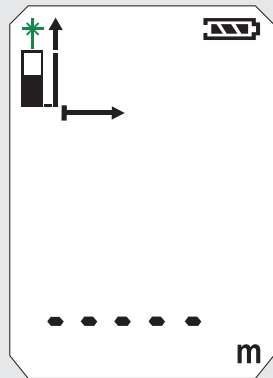

1

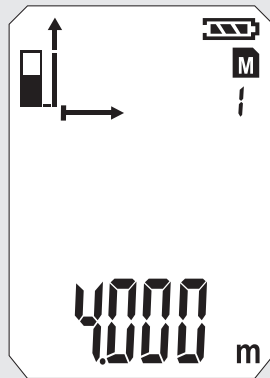
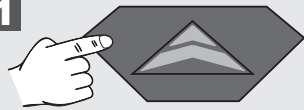

2

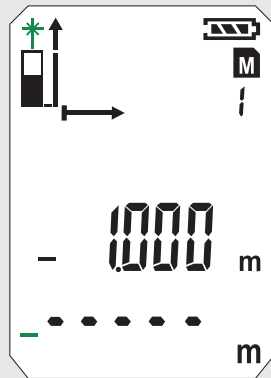
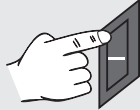

3

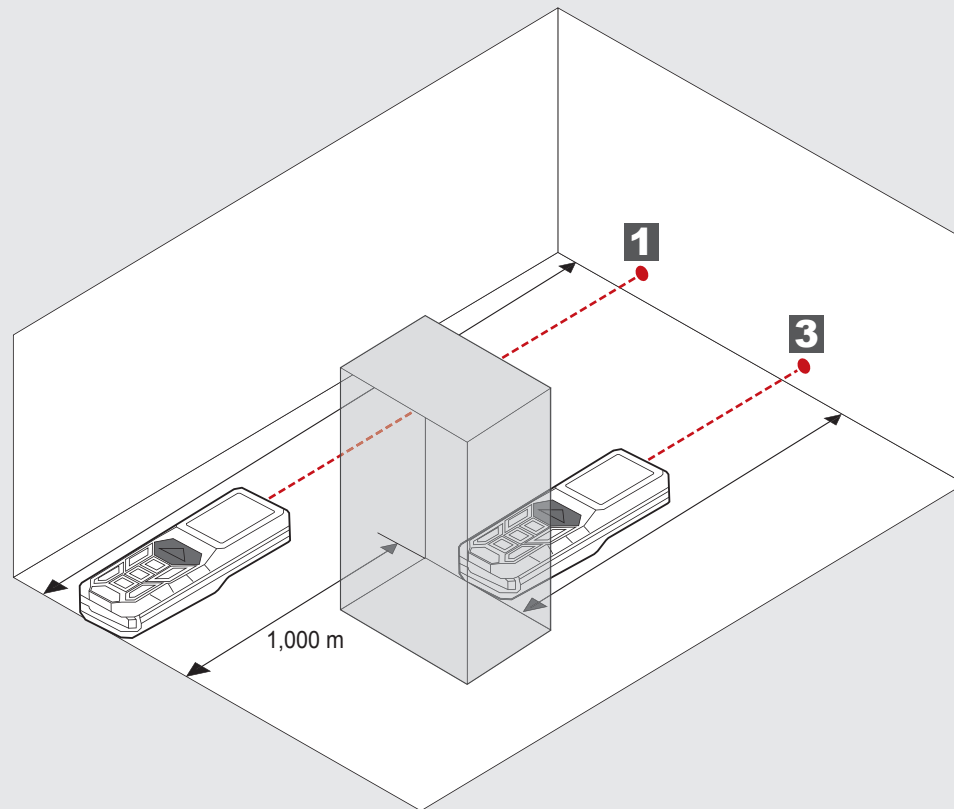
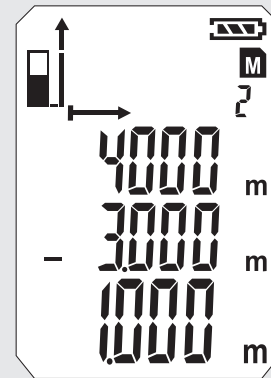
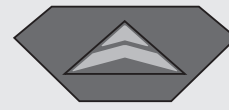

OVERFLATEMÅLING

0



1

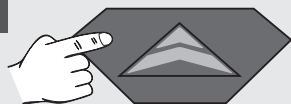

2

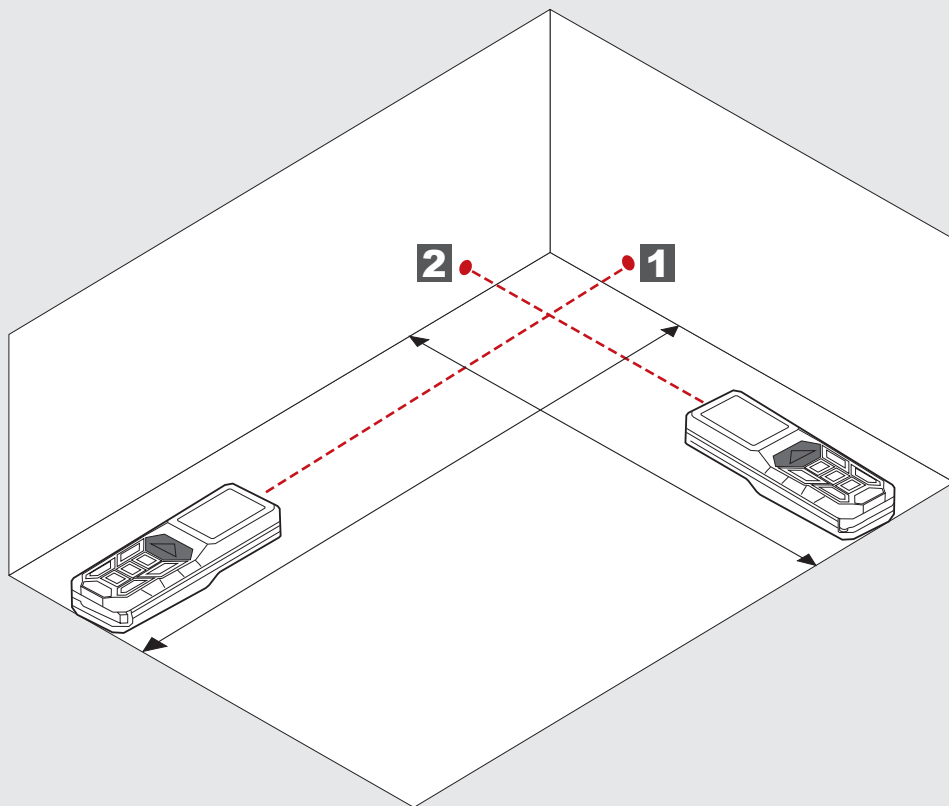
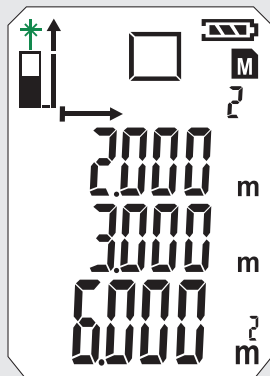
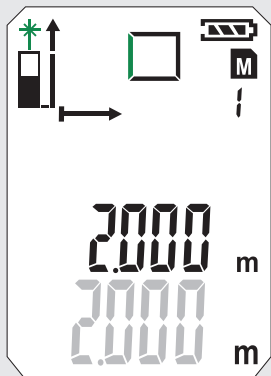
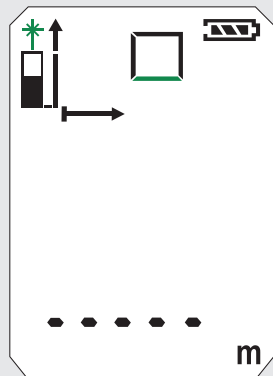
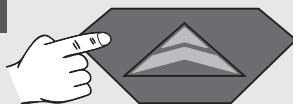

VOLUMMÅLING

0



1

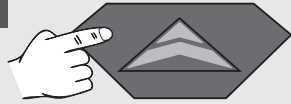

2

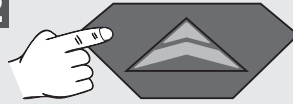

3

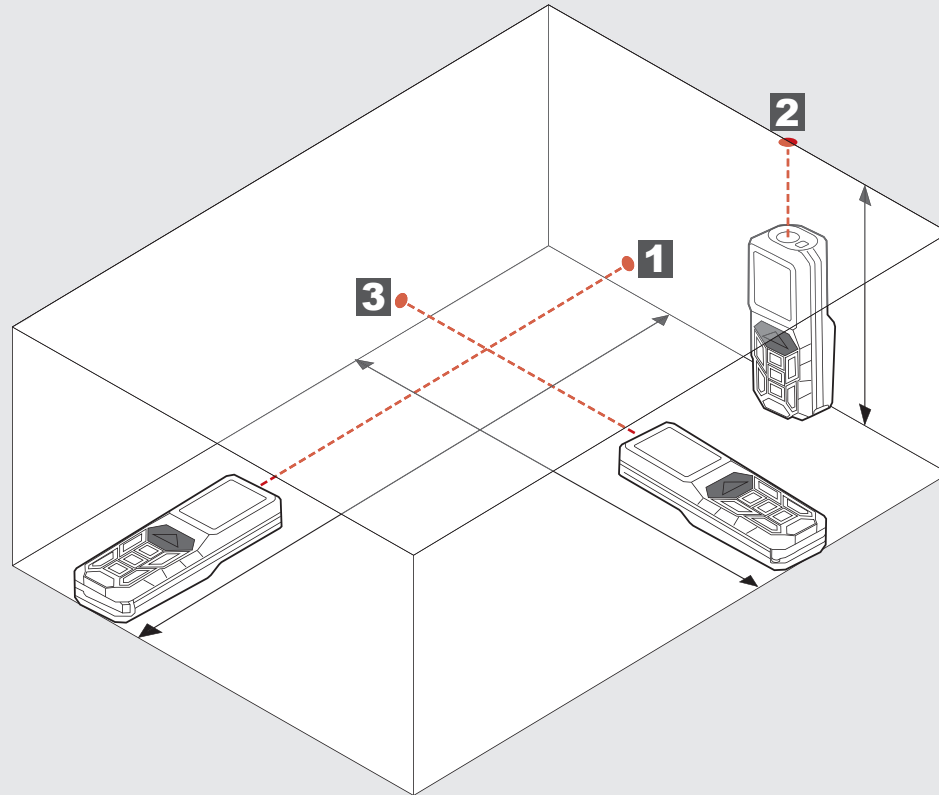
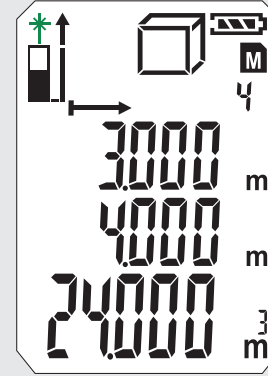
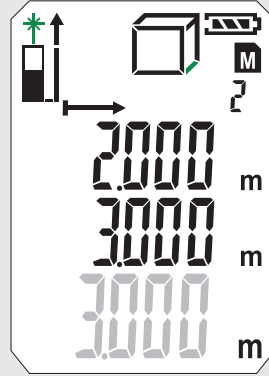
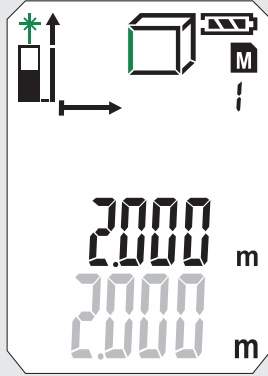
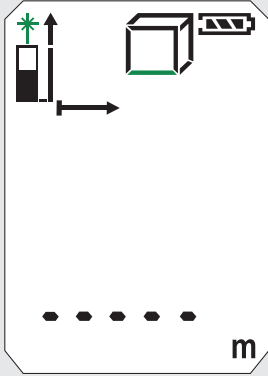
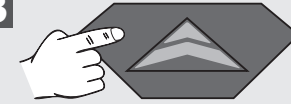

INDIREKTE MÅLING (PYTHAGORAS 1)

0





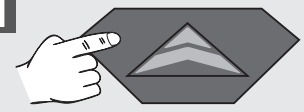

1

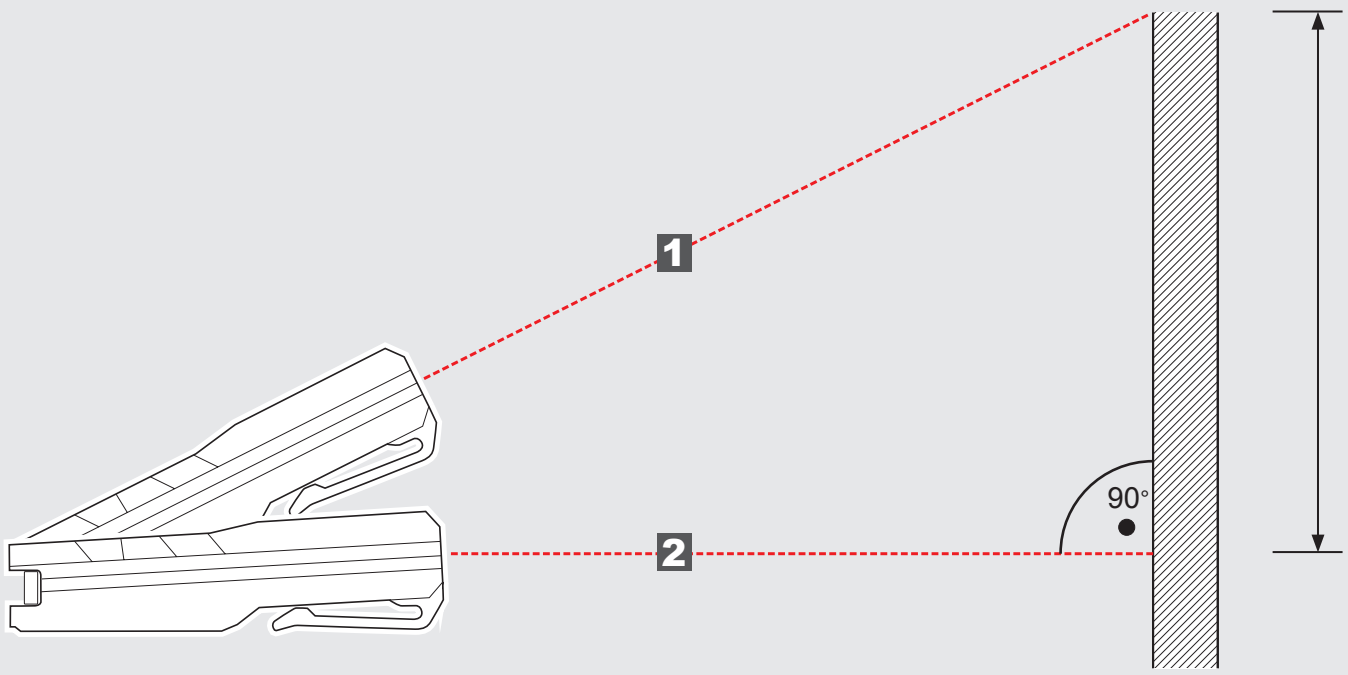
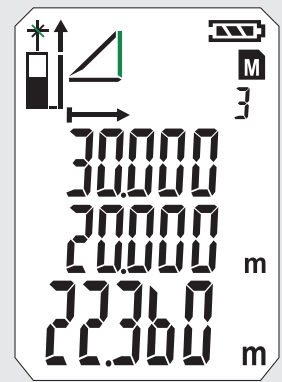
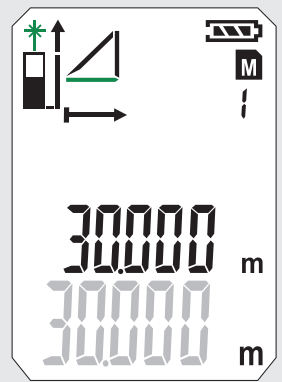
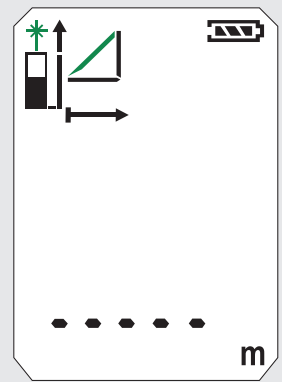
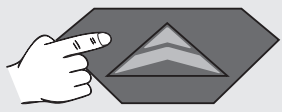

2

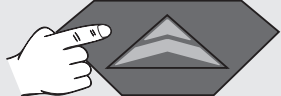

INDIREKTE MÅLING (PYTHAGORAS 2)

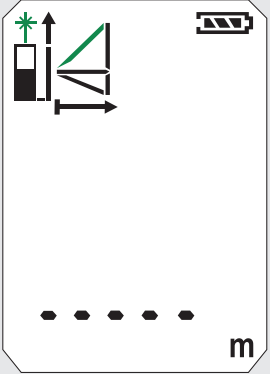
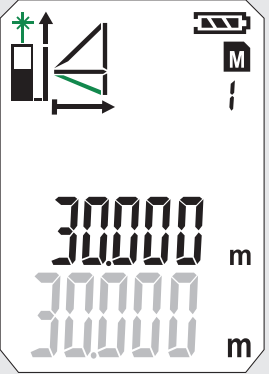
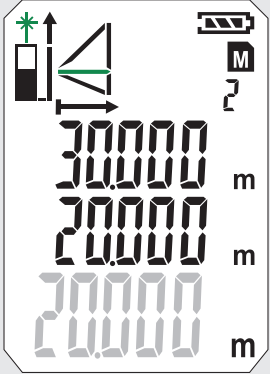
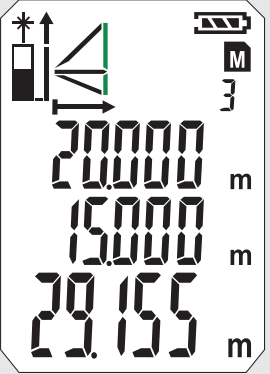
0 	1 	2 	3 
			

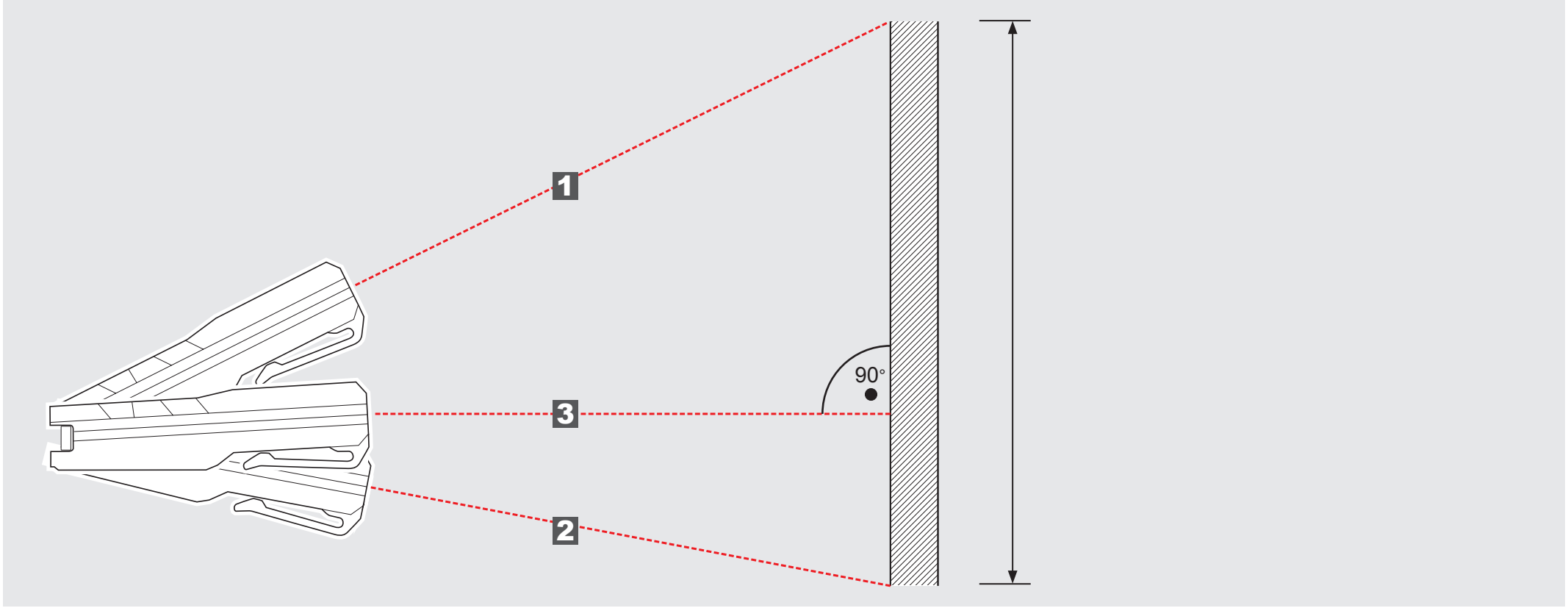

INDIREKTE MÅLING (PYTHAGORAS 3)

1



2

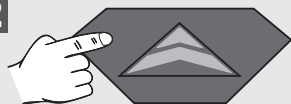



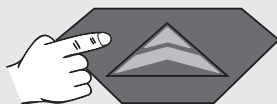

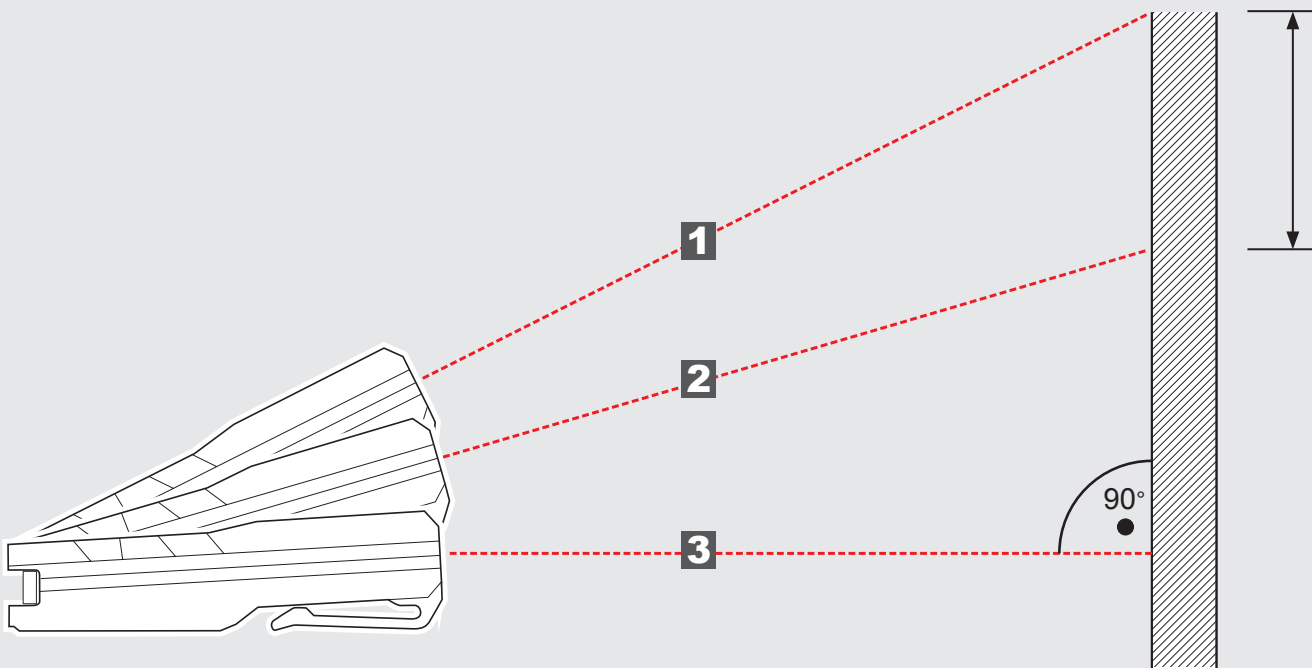
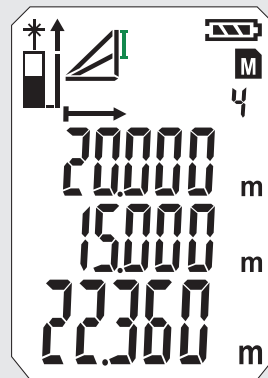
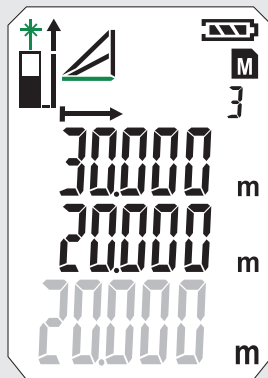
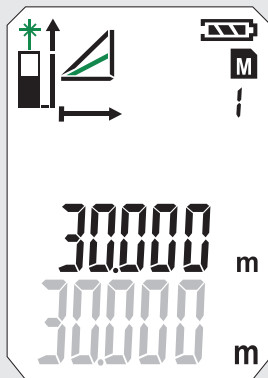
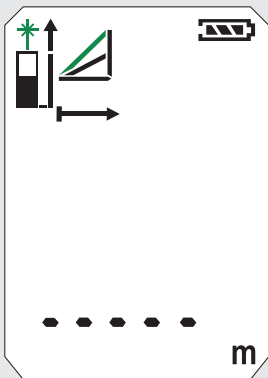

3



4

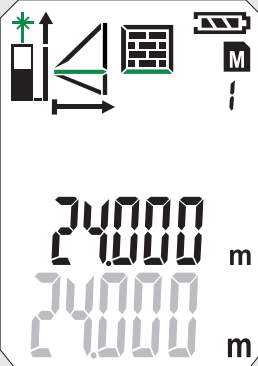
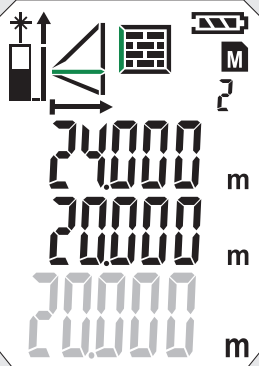
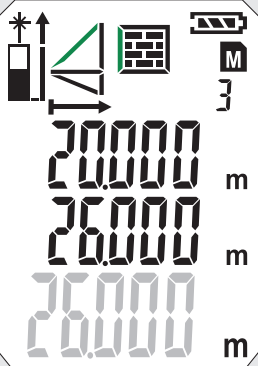
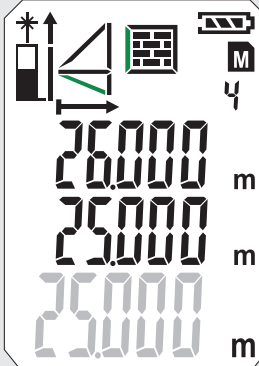

VEGGFLATE MÅLING (SCENARIO 1)

0 	1 	2 	3 	4 
				

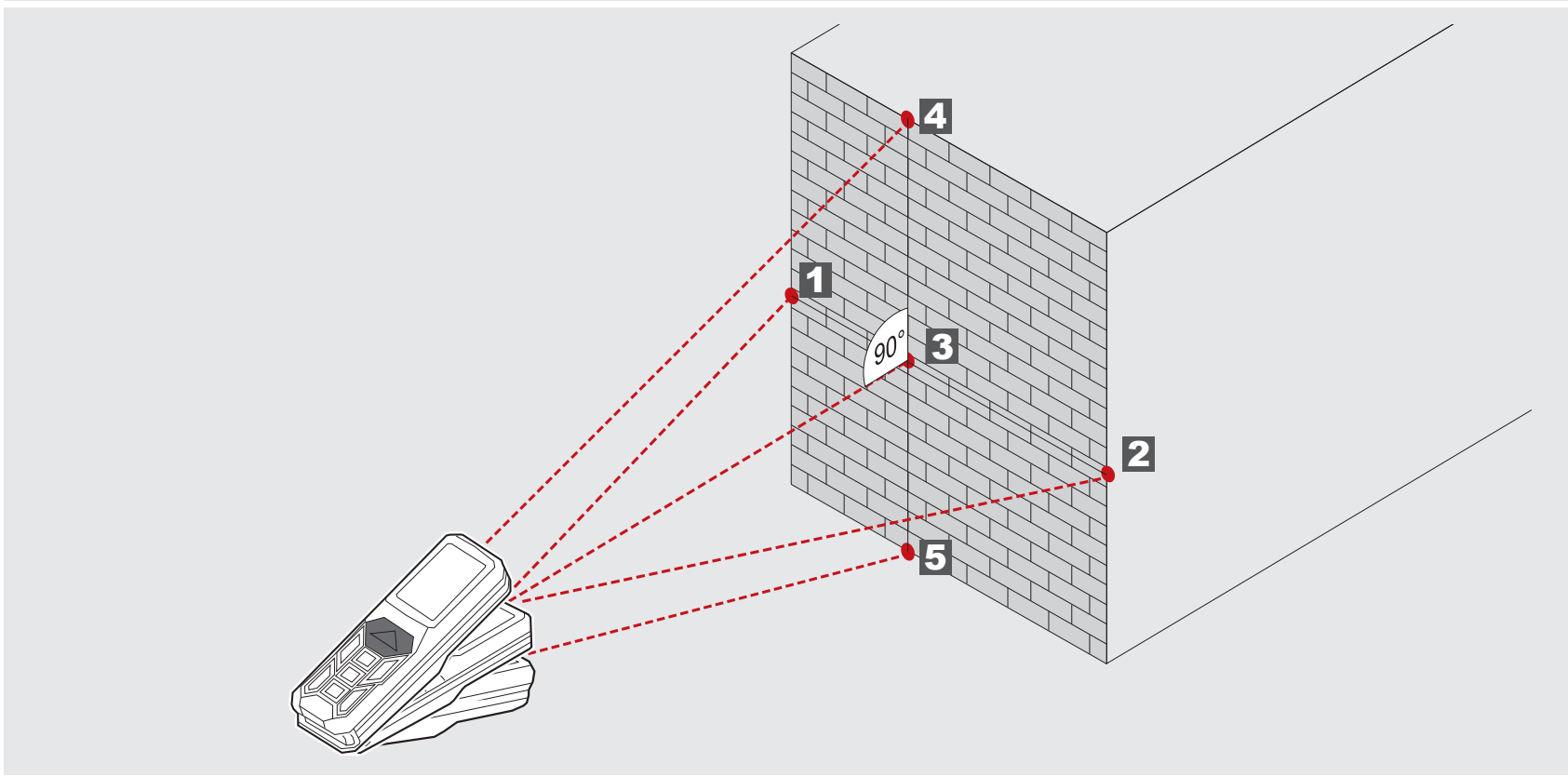



5

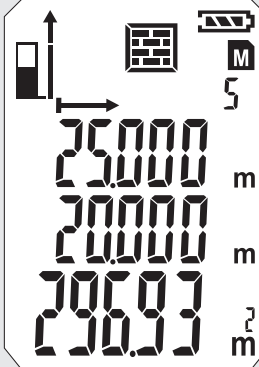

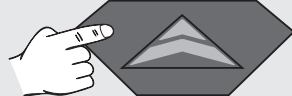
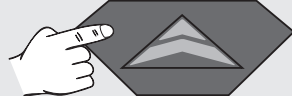
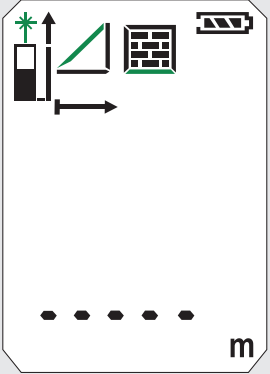
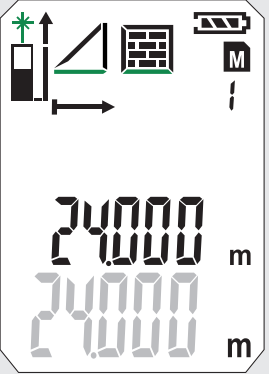
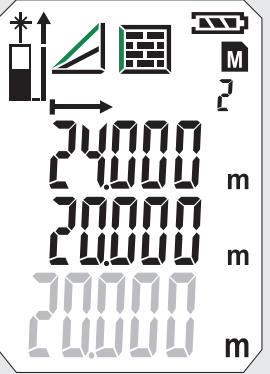
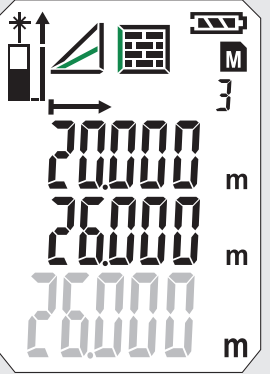
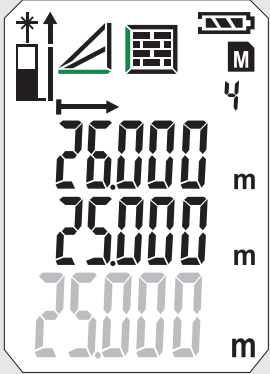

VEGGFLATE MÅLING (SCENARIO 2)

0 	1 	2 	3 	4 
				

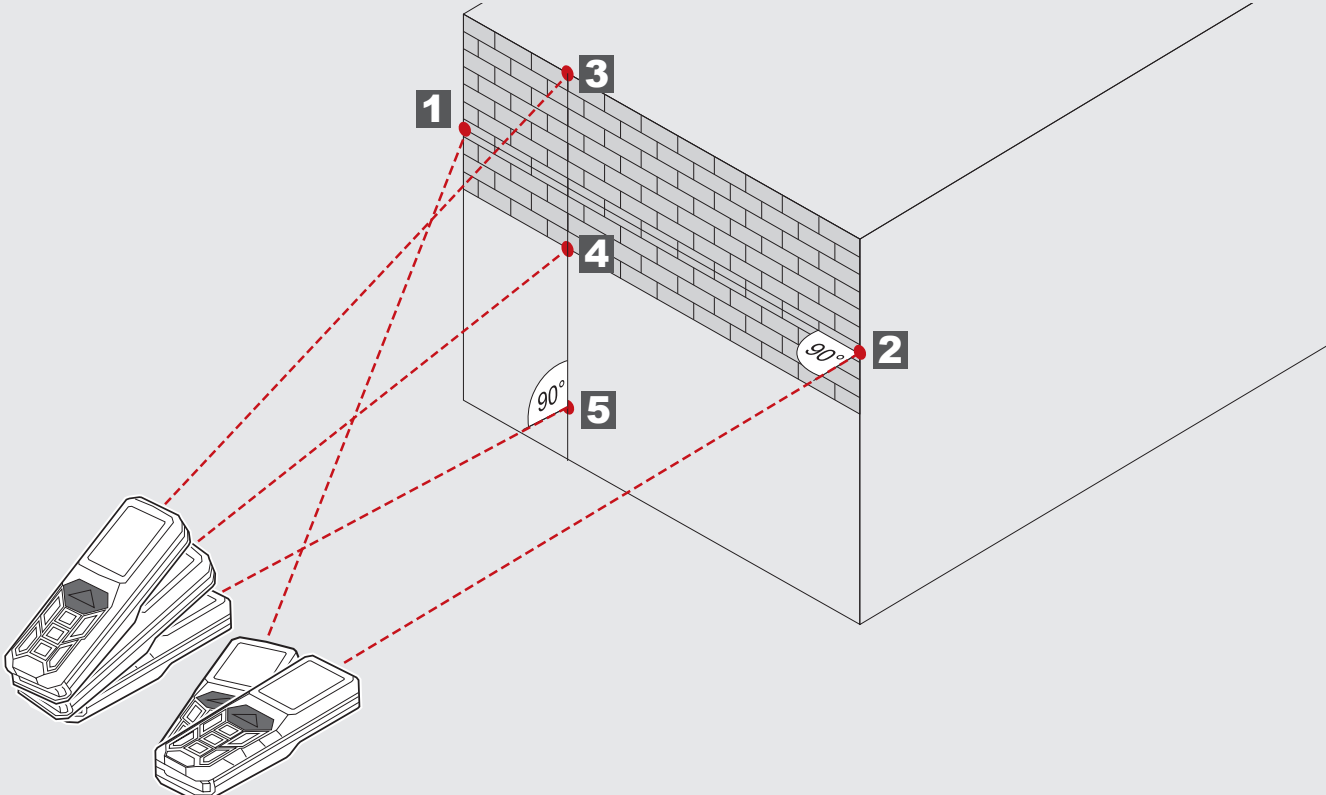

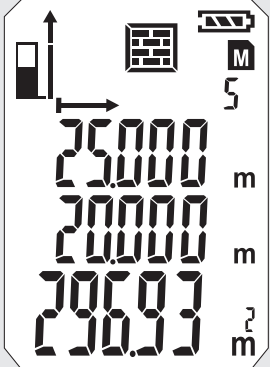

5





TIDSINNSTILLER

Med tidsinnstilleren kan målingen utløses forsinket, for f.eks. å posisjonere et byggelement i målestrålen.

Trykk tast 

- Symbolet vises i displayet
- Ved å trykke tast  kan tidsinnstilleren innstilles mellom 3 og 15 sekund.

Trykk tast 

- Sekundene telles ned til målingen starter.
- Ved 0 starter målingen.

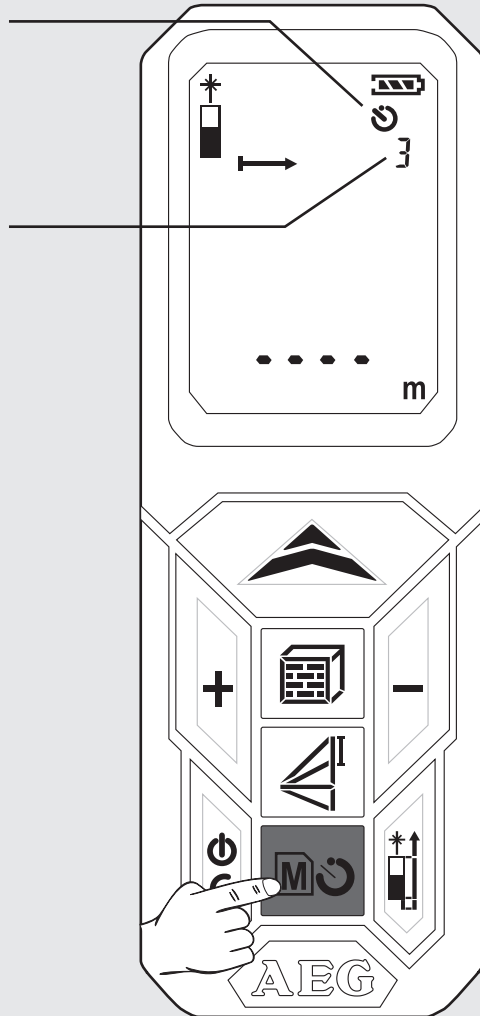

MINNE

Måleverdiene blir automatisk lagret fortløpende i minne.

De lagrede verdiene kan hentes fram ved å trykke tast .

Trykk tast  i 2 sekund

- Symbol og minneplass vises.
- Tilhørig målestørrelse blir vist.
- Lagret verdi blir vist i hovedlinjen.
- Naviger med +/- tasten

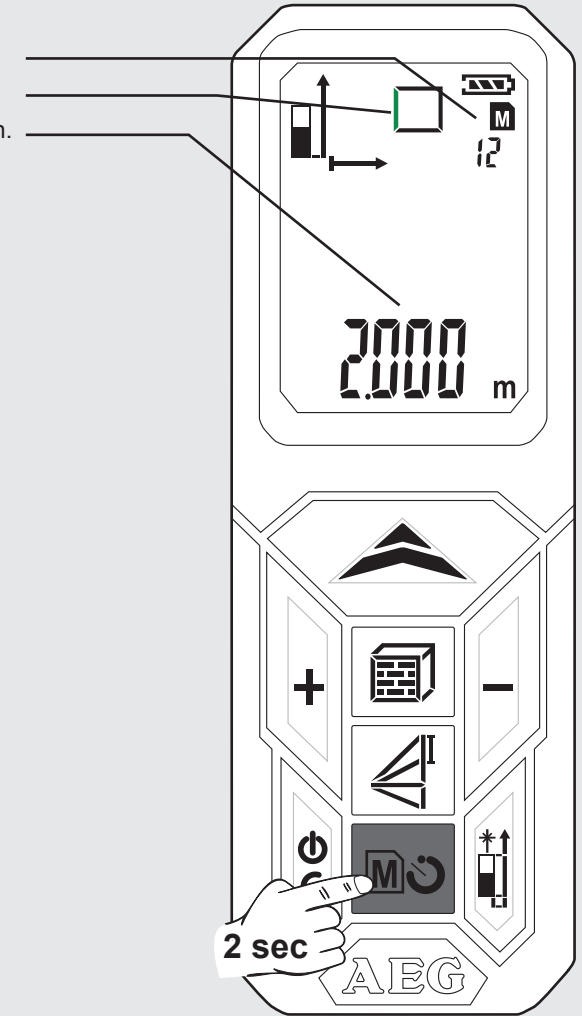

GRUNNLEGGENDE BRUKSBESKRIVELSE AV EKSEMPEL TIL EN OVERFLATEMÅLING (1)



1 Slå på

Trykk tast .
⚠ OBS! Laserstrålen er slått på!
 Ikke rett den mot personer!

Lasersymbol blinker
 (blinking blir vist i grønt).

2 Velg måle nivå

Standardinnstilling etter påslåing:
 bak

 trykk 1x -> Hjørnestift
 trykk 2x -> foran
 trykk 3x -> bak

Symbol blir vist i displayet

3 Velg funksjon

Når apparatet slås på, står det
 alltid på lengdemåling.
 trykk 1x - Overflatemåling

- Symbol vises
 - Målestørrelsen blinker
 (blinking blir vist i grønt)

4 Lengde måling

Innstill apparatet
 og trykk
 tast 

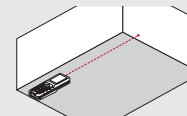

- Måleverdien vises kort i
 hovedlinjen.
 - Måleverdien hopper etter 1
 sekund i linjen over.
 Måleverdien lagres i minne etter
 fortløpende nummer.
 Målestørrelse nummer to blinker
 Apparatet er klart for måling av
 verdi nummer to.

5 Måle bredde

Innstill apparatet
 og trykk 

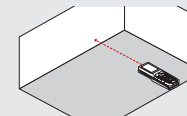

- Måleverdien vises kort i
 hovedlinjen.
 - Måleverdien hopper etter 1 sekund
 i linjen over.
 Måleverdien lagres i minne etter
 fortløpende nummer.
 - Resultat blir vist i hovedlinjen og
 lagres i minne etter fortløpende
 nummer.

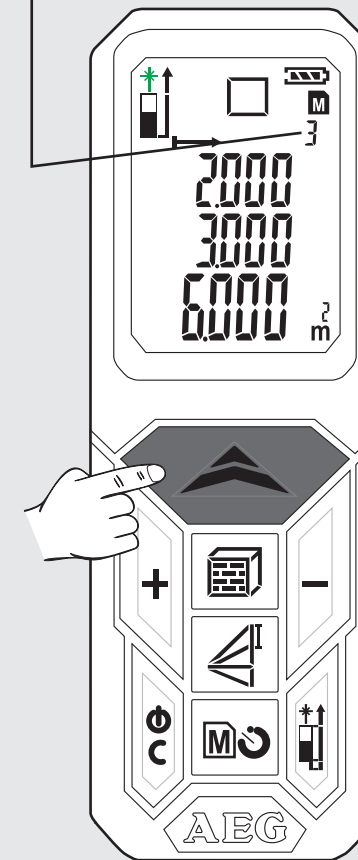
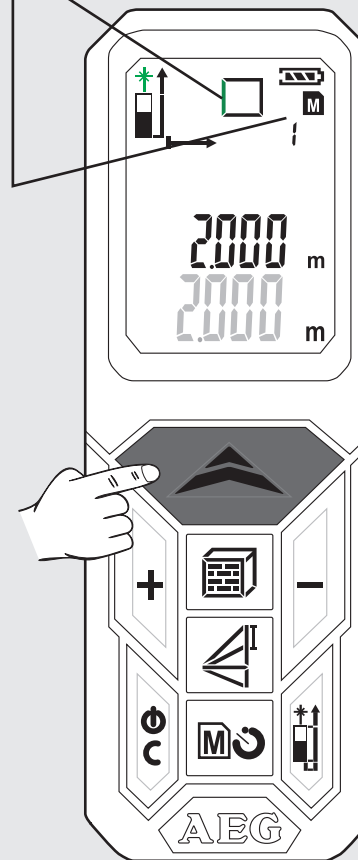
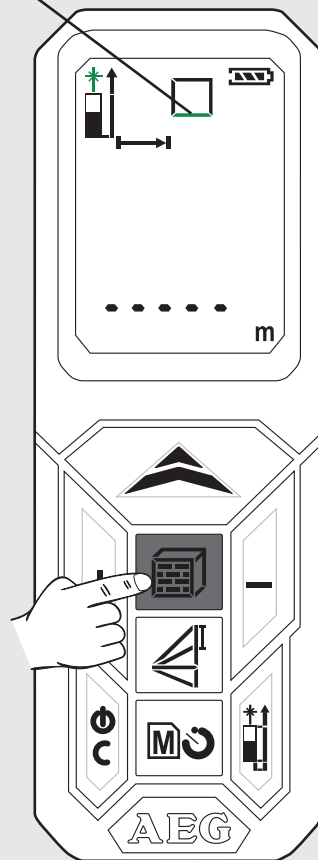
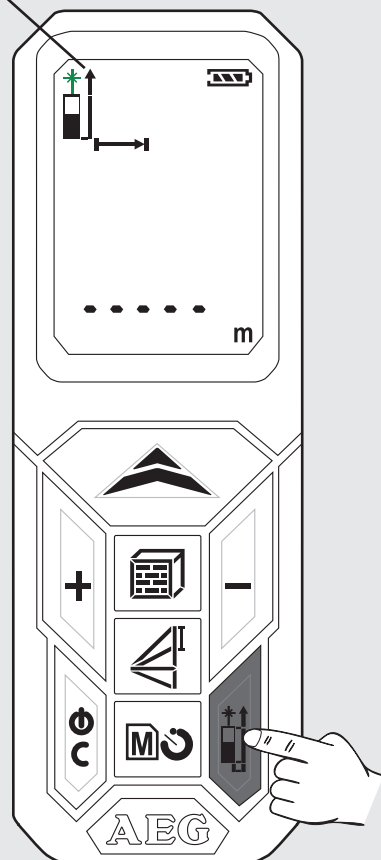
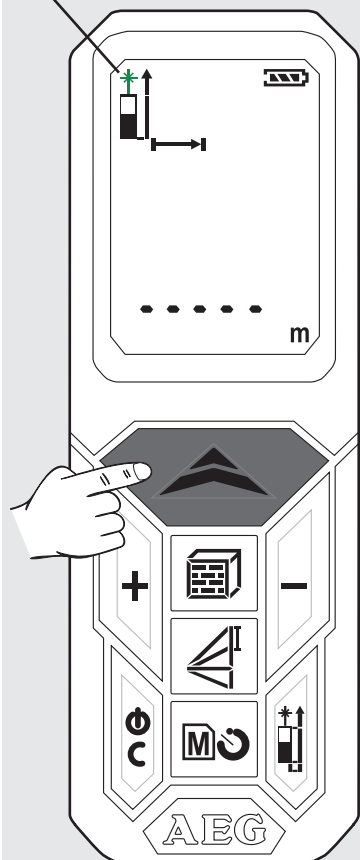

GRUNNLEGGENDE BRUKSBESKRIVELSE AV EKSEMPEL TIL EN OVERFLATEMÅLING (2)

6 Hente fram lagret verdi

Trykk tast  i 2 sekund.
Trykk tast + eller -

7 Forlat minne

Trykk tast 

8 Slå av

Trykk tast  i 2 sekund
(Minne må forlates først).

- Lagrede verdier blir vist i hovedlinjen.

- Det symbol som hører til blir vist og målestørrelsen blinker (blinking blir vist i grønt).

- Apparatet slås av.

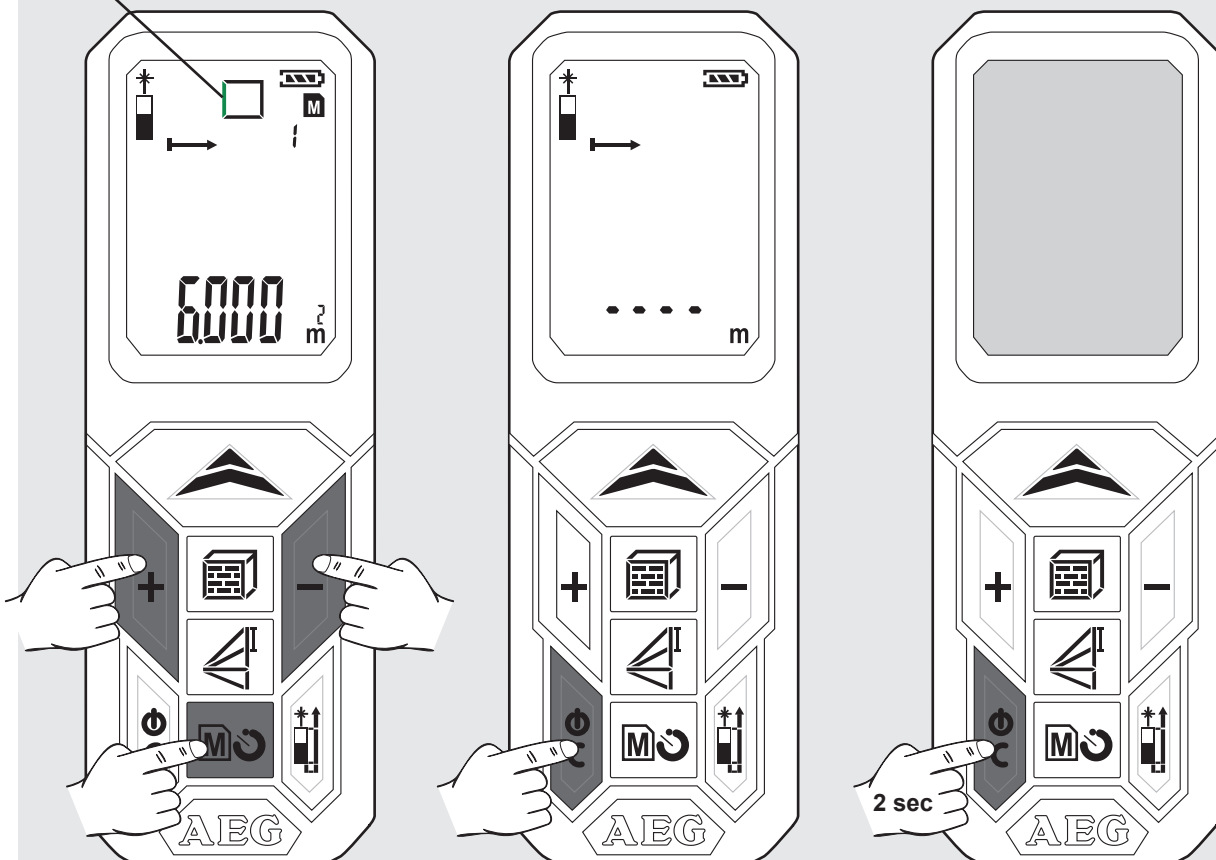

- Dersom i 3 minutt ingen tast blir trykket, slås apparatet automatisk av.



INNEHÅLL

Viktiga säkerhetsföreskrifter	1
Tekniska data.....	2
Använd maskinen enligt anvisningarna	2
Tabell med felkoder	2
Översikt	3
Byte av batteri.....	4
Hörnpinne	4
Bälteshållare.....	4
Funktionsknapp, Pythagoras, mätnivå	5
Enkel längdmätning.....	6
Kontinuerlig mätning/minimum-maximum mätning.....	7
Additions- / Subtraktionsmässung.....	8
Areamätning	9
Volymmätning	10
Indirekt mätning (Pythagoras 1)	11
Indirekt mätning (Pythagoras 2)	12
Indirekt mätning (Pythagoras 3)	13
Mätning väggarea (Scenario 1)	14
Mätning väggarea (Scenario 2)	15
Timer	16
Minne.....	16
Grundläggande funktionssätt beskrivet med en areamätning som exempel (1).....	17
Grundläggande funktionssätt beskrivet med en areamätning som exempel (2).....	18

VIKTIGA SÄKERHETSFÖRESKRIFTER

  Använd inte denna produkt utan att läsa säkerhetsföreskrifter och handbok på bifogad CD.

Laserklassificering

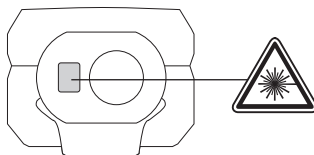

VARNING:

Produkten motsvarar klass 2 enligt: IEC 60825-1:2007.



Märkning

Före första idrifttagning: Klistra över den engelska texten på märkskylten med medföljande etikett på det aktuella landets språk.

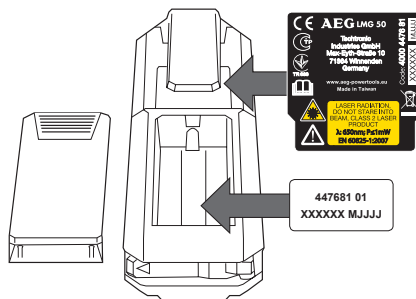

Varning:

Undvik direkt blickkontakt: Laserstrålen kan blixtra i ögonen och leda till en kortvarig bländning.

Titta inte in i laserstrålen och rikta den inte mot andra personer i onödan.

Blända inte andra personer.

Varning:

Använd laser-apparaten aldrig i närheten av barn och tillåt barn aldrig att använda laser-apparaten.

Varning! En reflekterande yta kan kasta tillbaka laserstrålen till användaren eller andra personer.

Håll fingrarna på säkert avstånd från roterande komponenter.

Utför periodiska kontrollmätningar. Särskilt före, under och efter viktiga mätningar.

Se upp för felaktiga mätningar om en defekt produkt används, efter ett fall eller andra otillåtna påfrestningar resp. förändringar av produkten.

Obs! Gör dig förtrogen med trädgårdsredskapets manöverorgan och dess korrekta användning.

Lasermätinstrumentet har ett begränsat användningsområde. (Se avsnittet "Tekniska data"). Försök att göra mätningar utanför det maximala resp. det minimala området leder till bristande noggrannhet. Användning vid ogynnsamma förhållande som för kallt, för varmt, starkt solljus, regn, snö, dimma eller andra förhållanden som begränsar sikten kan leda till oprecisa mätningar.

Om lasermätinstrumentet förs från en varm omgivning till en kall omgivning (eller tvärt om), vänta tills instrumentet har anpassat sig till den nya omgivningstemperaturen.

Förvara alltid lasermätinstrumentet i utrymmen som skyddar instrumentet mot skakningar, vibrationer eller extrema temperaturer.

Skydda lasermätinstrumentet mot damm, fukt och hög luftfuktighet. Detta kan förstöra komponenter inne i instrumentet påverka noggrannheten.

Använd inga aggressiva rengöringsmedel eller lösningsmedel. Rengör endast med en ren, fuktig trasa.

Undvik kraftiga slag mot instrumentet och låt det inte falla till marken. Instrumentets noggrannhet bör kontrolleras om det har fallit till marken eller har utsatts för andra mekaniska belastningar.

Om denna laser-apparat behöver repareras så får endast auktoriserad fackpersonal utföra reparationen.

Använd inte produkten i aggressiv eller explosiv miljö.

Använd endast batteriladdare rekommenderade av tillverkaren för att ladda batterier.



Tomma batterier får inte avfallshanteras som hushållssopor. Tänk på miljön och lämna in batterierna till närmaste återvinningsstation enligt gällande miljölagstiftning. Instrumentet får inte avfallshanteras som hushållssopor. Se till att instrumentet skrotas på ett sådant sätt att nationella regler efterlevs. Följ nationella och landsspecifika regler. Kontakta de lokala myndigheterna eller återförsäljaren om du har frågor som gäller avfallshanteringen.



CE-symbol

TEKNISKA DATA

Skyddsklass	IP54 (damm- och stänkvattenskydd)
Optik	14 mm
Brännpunkt	35 mm
Mätområde max.	50 Meter (tolerans: 55 m)
Mätområde min.	0,05 meter
Absolut noggrannhet @ < 10m	± 1,5 mm (max)
Repeternoggrannhet @ < 10m	± 1,5 mm (typisk max. 2σ)
Repeternoggrannhet @ > 10m	Stigning± 0,25 mm / meter (typisk max. 2σ)
Mättid	0,5 s
Displaytyp	LCD (22,7 mm x 31 mm)
Strömförsörjning	AAA 2x (alkali-batteri)
Batteriets livstid	10000 (enskild mätning)
Laser uteffekt	0,6 mW ~ 0,95 mW (Klass 2, 650nm)
Laserpunktstorlek	25 x 30 mm @ 16 m (max)
Laserstråle vertikalvinkel	+1 grad
Laserstråle horisontalvinkel	±1 grad
Automatisk apparatavstängning	180 sekunder
Automatisk laseravstängning	30 sekunder
Arbetstemperaturområde	-10°C till +50°C
Lagertemperaturområde	-25°C till +70°C
Vikt utan batteri	80 g

ANVÄND MASKINEN ENLIGT ANVISNINGARNA

Lasermätinstrumentet är avsett att användas för mätning av avstånd och lutningar.

Maskinen får endast användas för angiven tillämpning.

TABELL MED FELKODER

Kod	Beskrivning	Lösning
Err01	Utanför mätområdet	Utför mätningen inom det avsedda området.
Err02	Reflekerad signal är för svag	Välj en bättre yta.
Err03	Utanför visningsområdet (max. värde: 99.999) t.ex. ligger resultatet av arean eller volymen utanför visningsområdet	Kontrollera om värdena och stegen är korrekta.
Err04	Fel i Pythagorasberäkningen	Kontrollera om värdena och stegen är korrekta.
Err05	Batteri svagt	Sätt i nya batterier.
Err06	Utanför arbetstemperaturområdet	Utför mätningen inom det angivna arbetstemperaturområdet.
Err07	För ljusst omgivningsljus	Fördunkla delområde

Pythagoras
Höjdskillnad

Mätnivå

Längdmätning

Minimum/maximum för kontinuerlig mätning

Addition/subtraktion

Area/volym
Indirekt ytmätning

Batteristatus

Minne

Timer

Kontinuerlig mätning

Mellanvärden

Totalvärde

PÅ/MÄTNING

- ▶ På
- ▶ Mätning
- ▶ Kontinuerlig mätning (tryck 2 sek)
Min./max. funktion

ADDITION

- ▶ Addera värde
- ▶ Navigera i minnet

AREA/VOLYM

- ▶ Area (tryck 1x)
- ▶ Volym (tryck 2x)
- ▶ Indirekt ytmätning (tryck 3x/4x)

PÅSLAGNING

- ▶ På
- ▶ Av (tryck 2 sek)
- ▶ Återställ

SUBTRAKTION

- ▶ Subtrahera värde
- ▶ Navigera i minnet

PYTHAGORAS

- ▶ Pythagoras 1 (tryck 1x)
- ▶ Pythagoras 2 (tryck 2x)
- ▶ Pythagoras 3 (tryck 3x)

BYT MÄTNIVÅ

- ▶ Framtill
- ▶ Baktill
- ▶ Hörnpinne

MINNE

- ▶ Timer 3-15 sek (tryck 1x)
- ▶ Minne 1-20 (tryck 1x 2 sek)
- ▶ Navigera i minnet med +/- knapparna

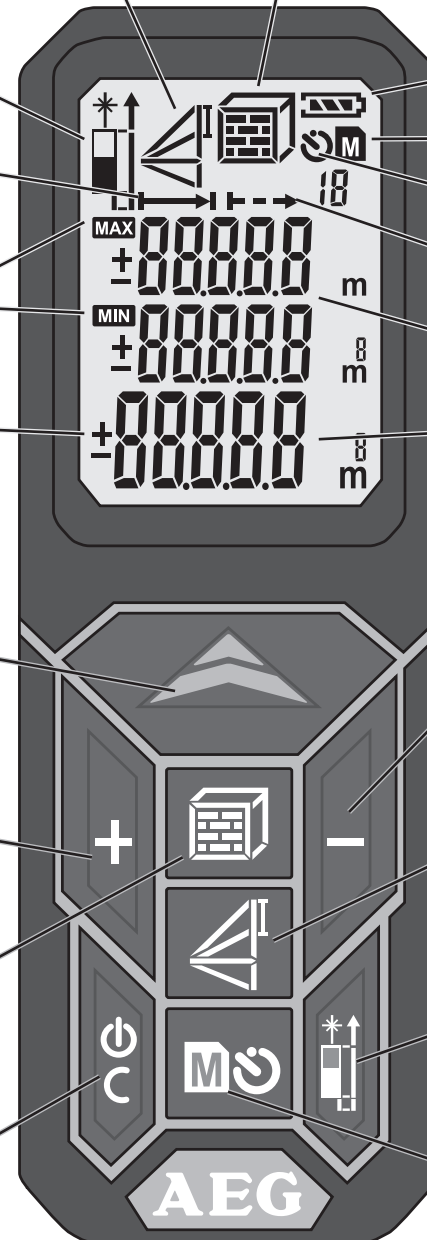

BYTE AV BATTERI

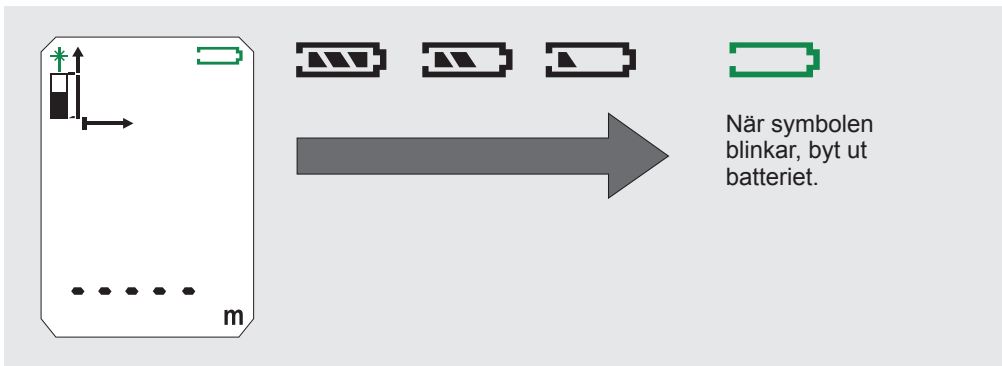

1

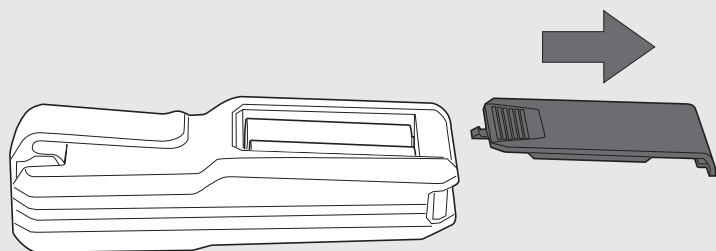

2

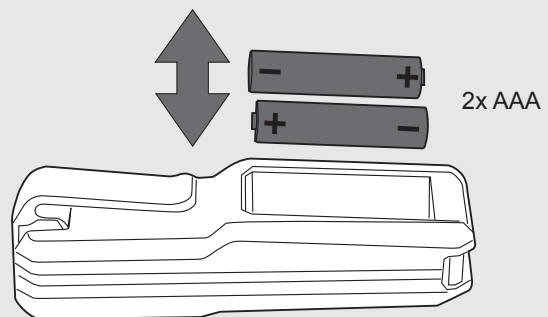

3

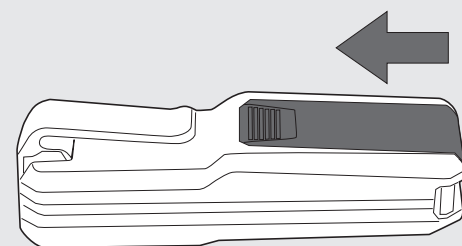

HÖRNPINNE

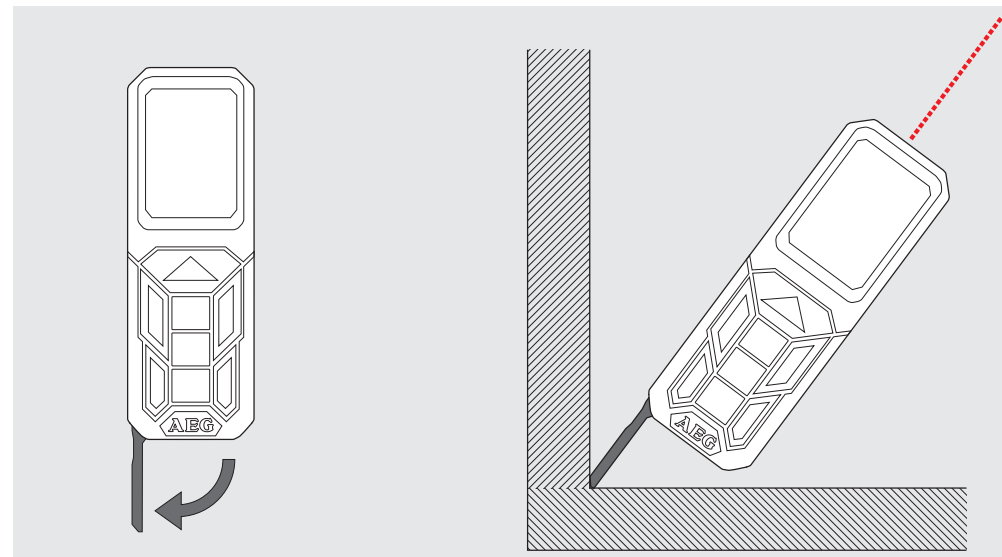

BÄLTESHÅLLARE

1

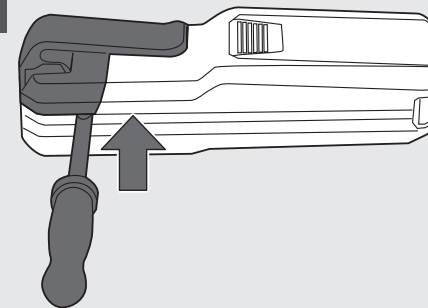

2

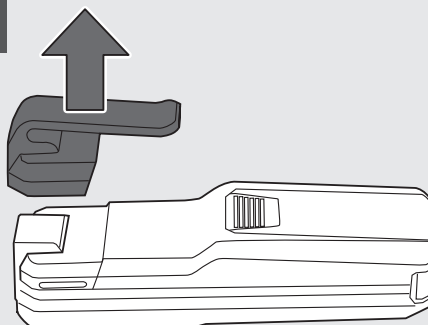

3

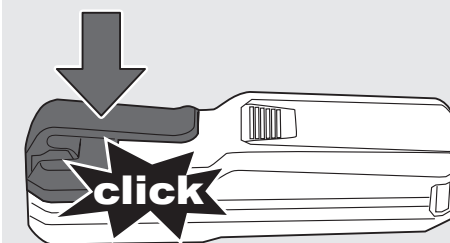

FUNKTIONSKNAPP, PYTHAGORAS, MÄTNIVÅ

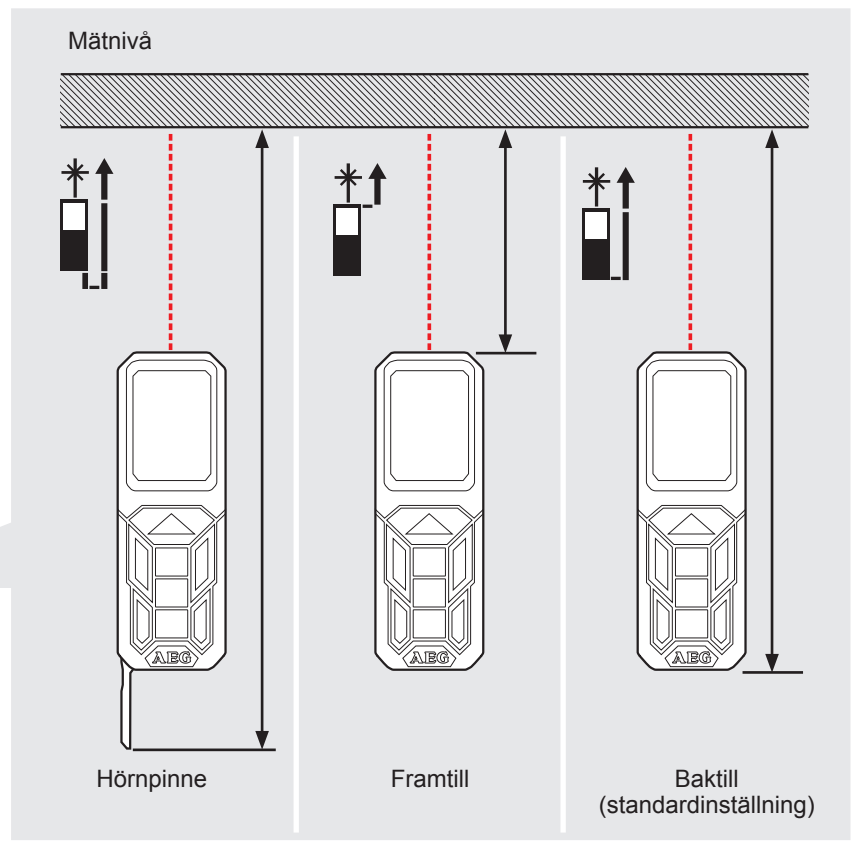
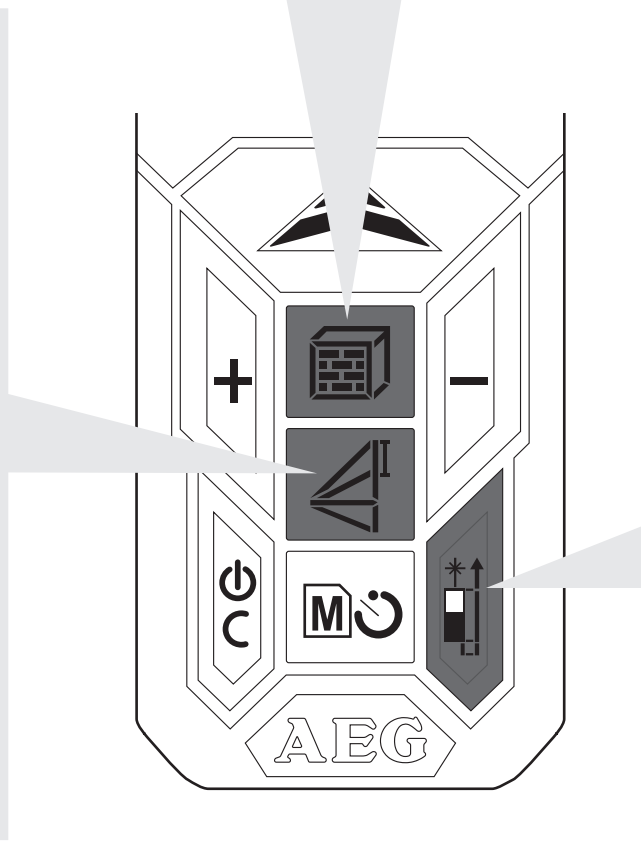
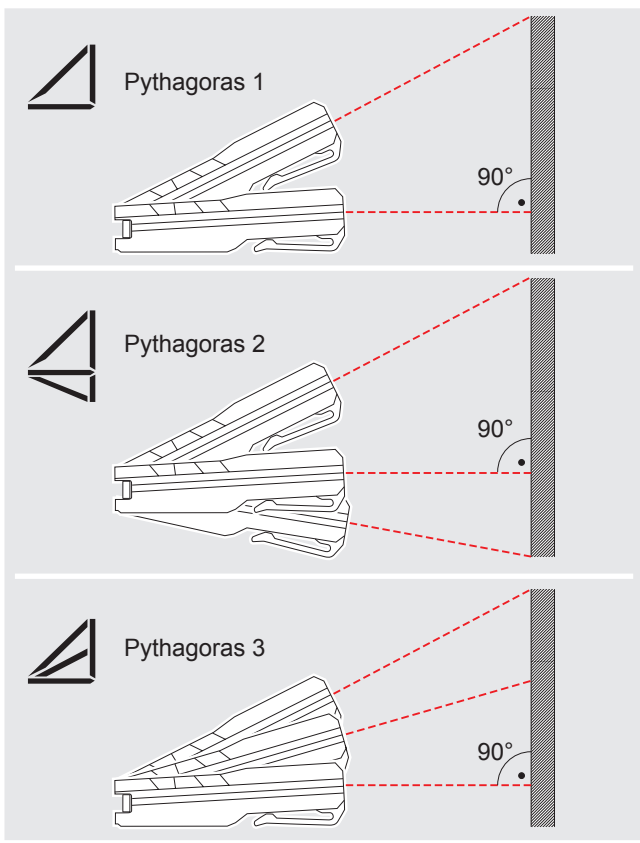
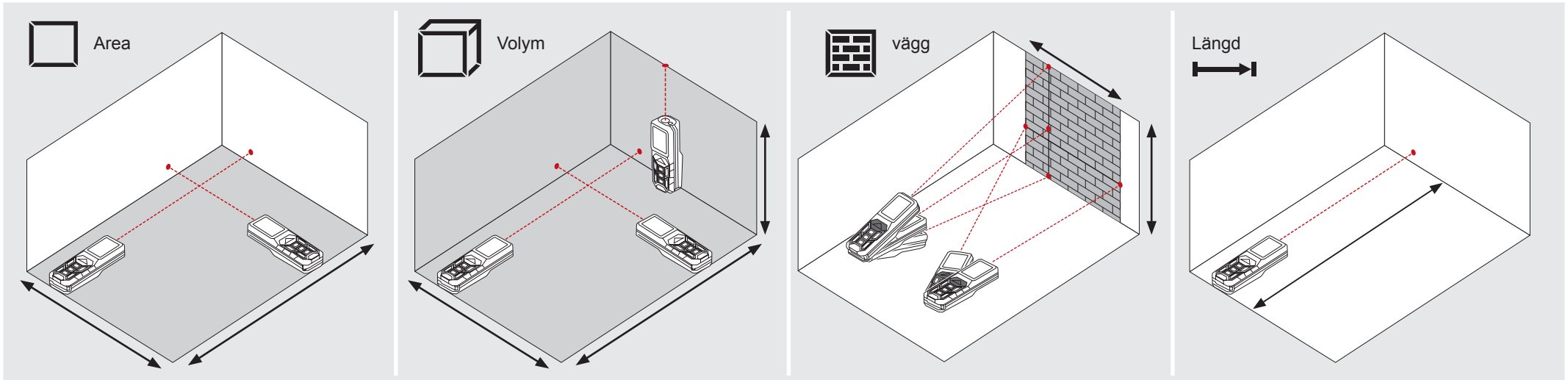

ENKEL LÄNGDMÄTNING

0

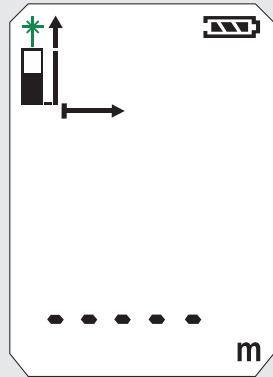

1

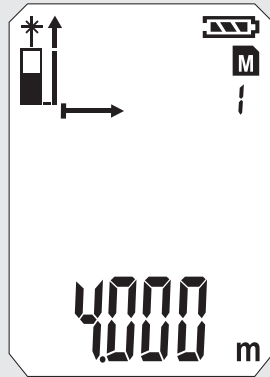
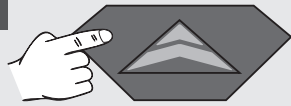

2

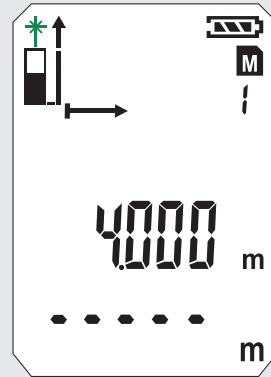
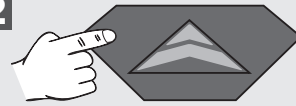

3

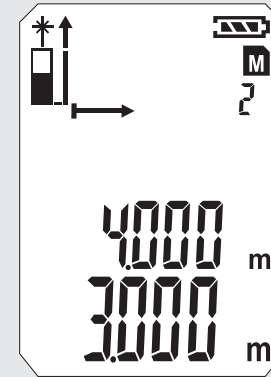
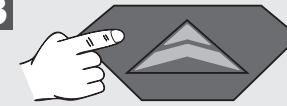

4

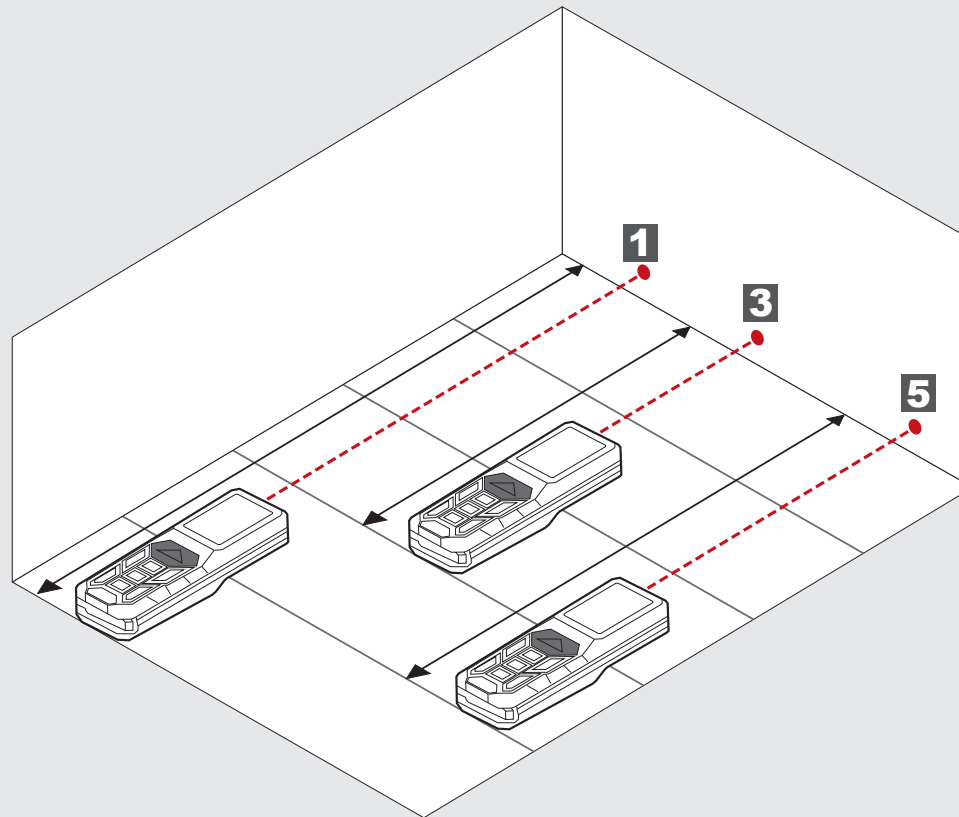
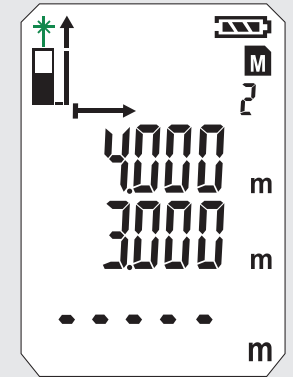
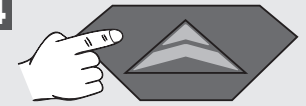

5

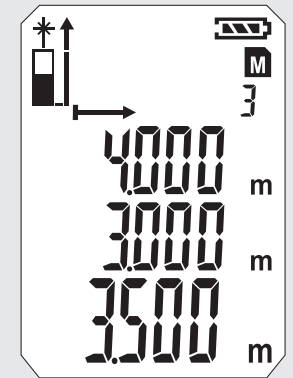
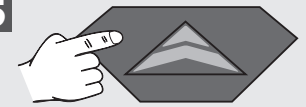

KONTINUERLIG MÄTNING/MINIMUM-MAXIMUM MÄTNING

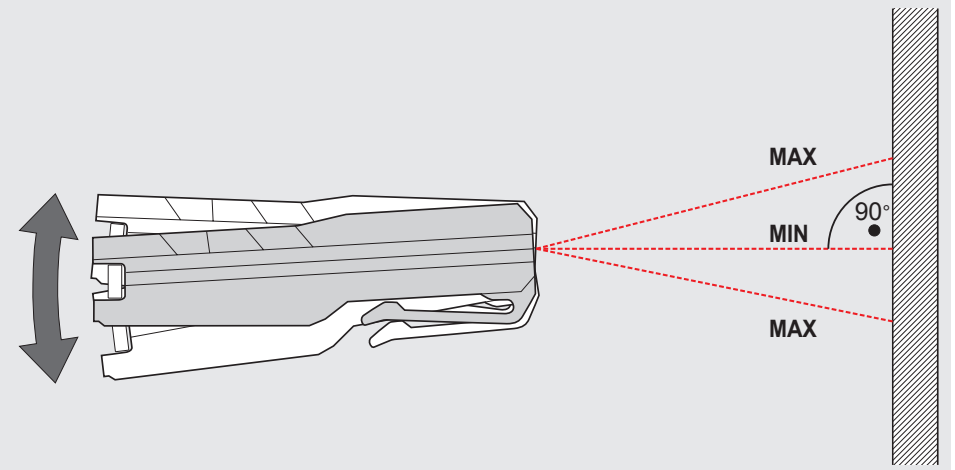
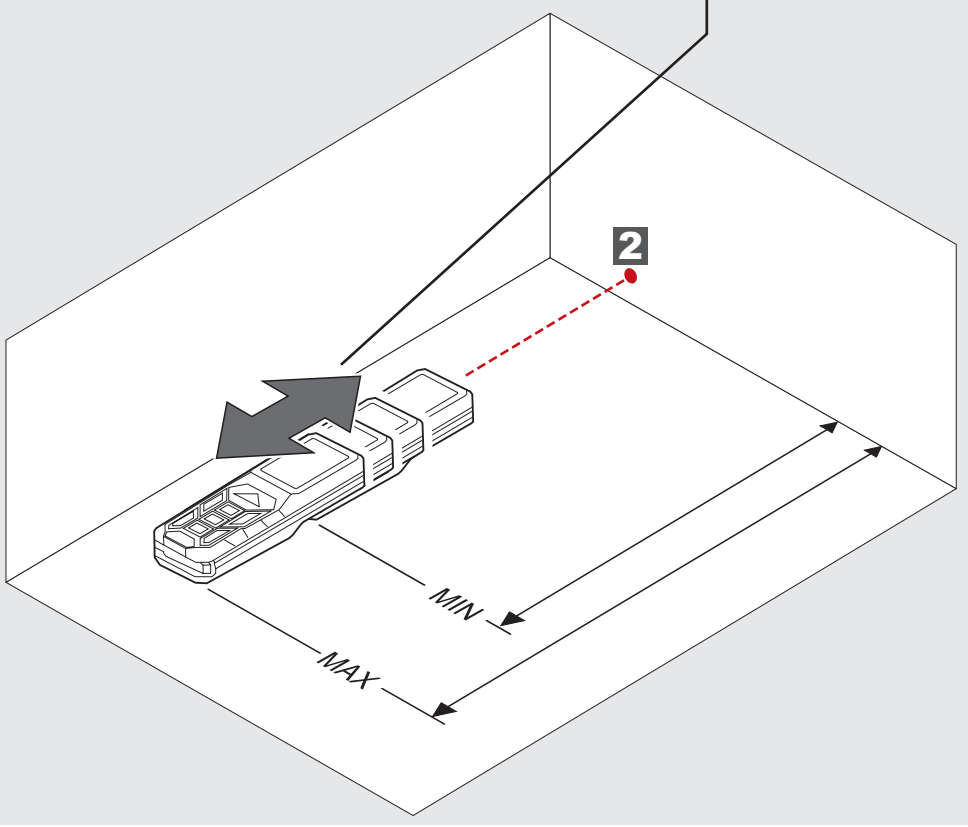
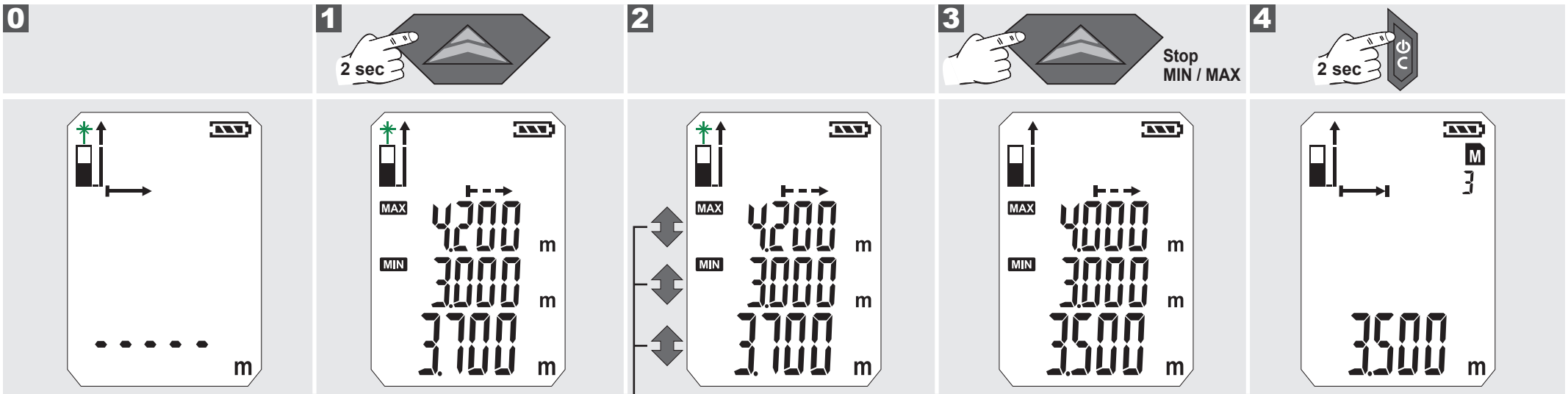

0

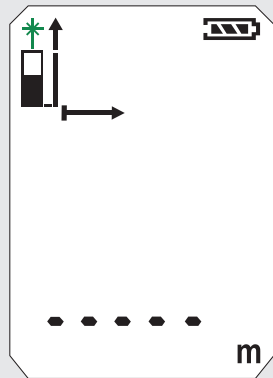

1

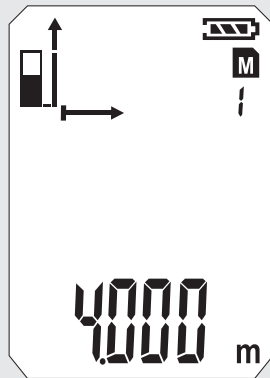
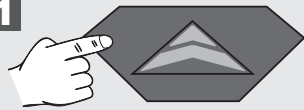

2

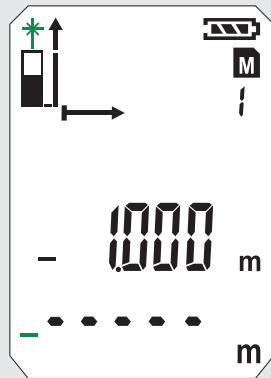
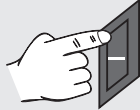

3

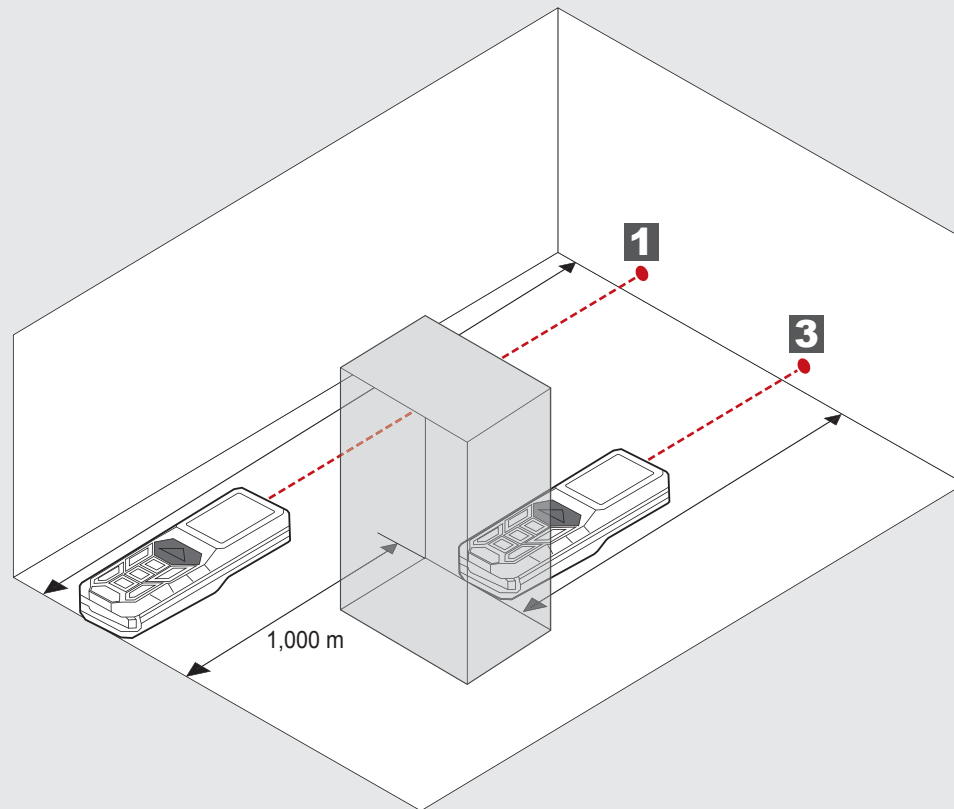
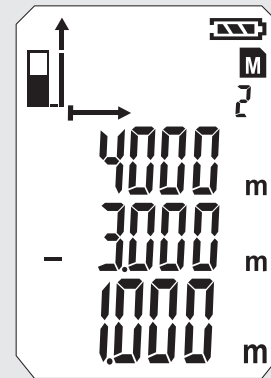
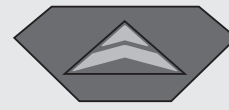

AREAMÄTNING

0



1

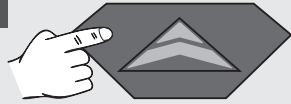

2

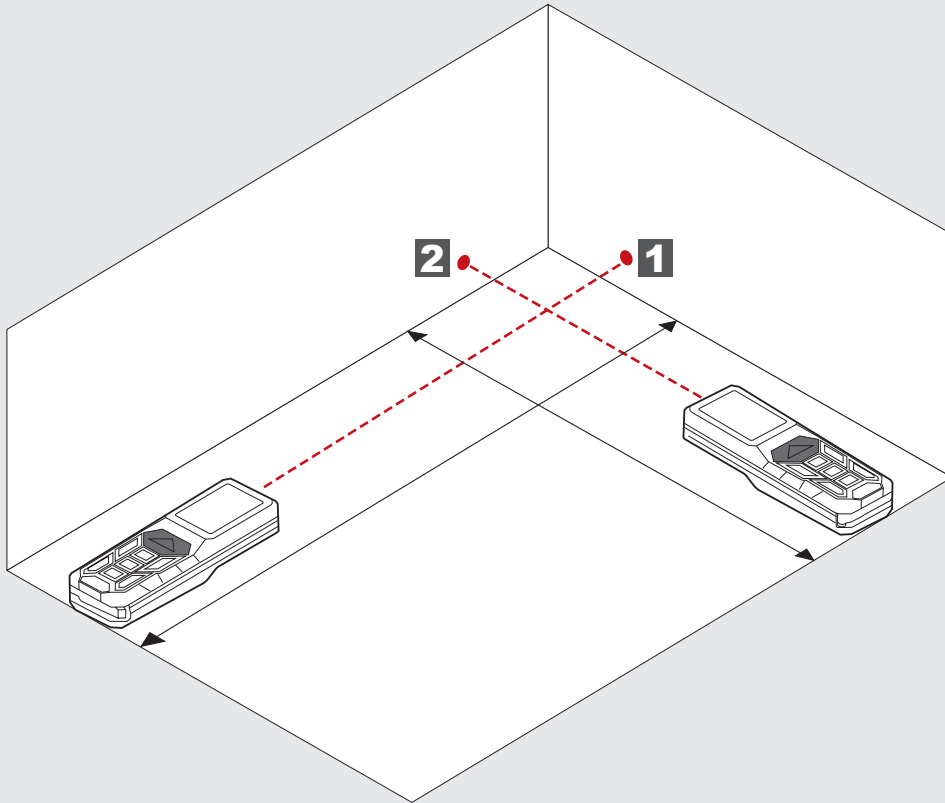
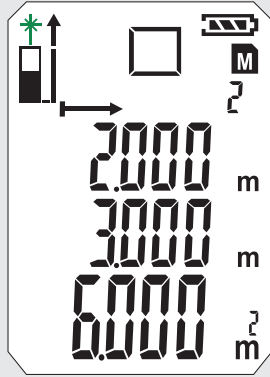
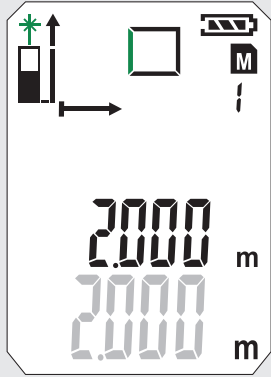
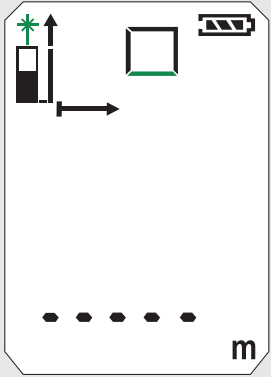
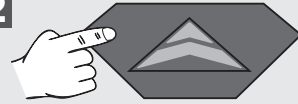

VOLYMMÄTNING

0

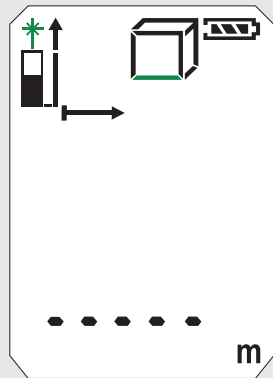

1

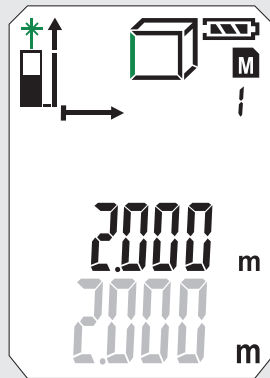
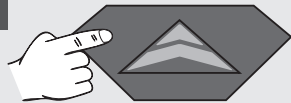

2

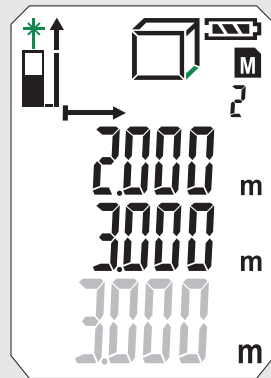
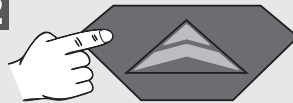

3

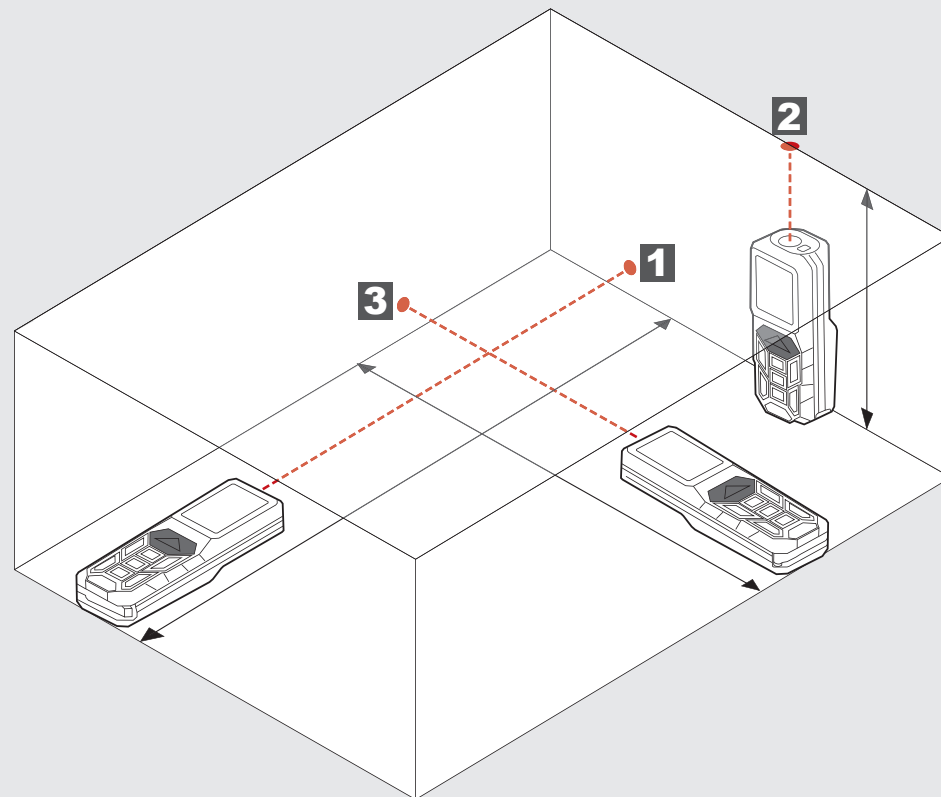
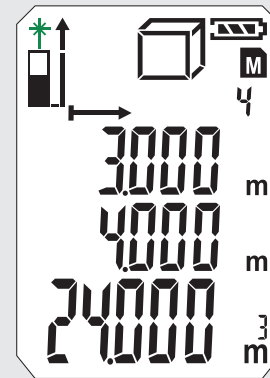
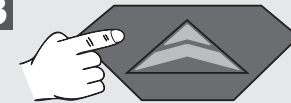

INDIREKT MÄTNING (PYTHAGORAS 1)

0



1

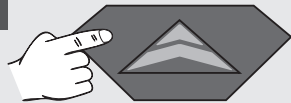

2

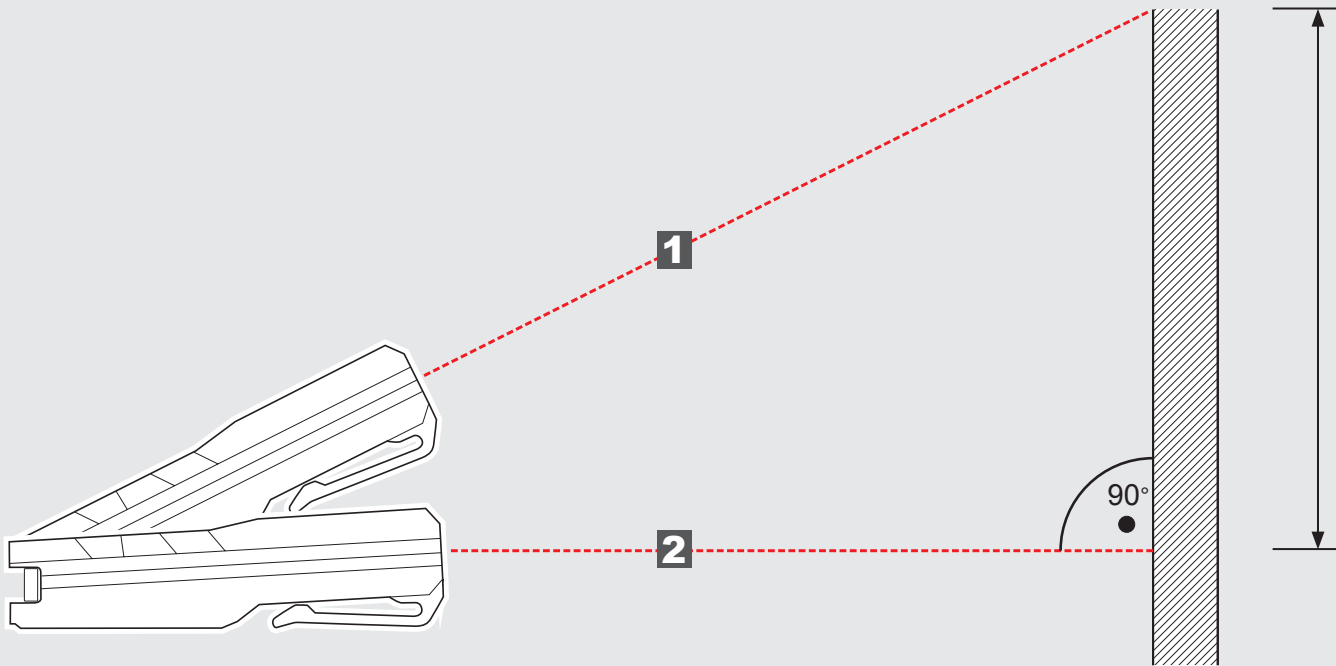
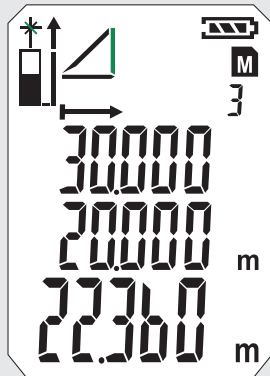
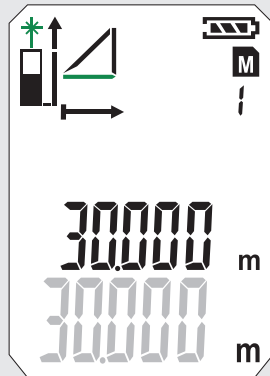
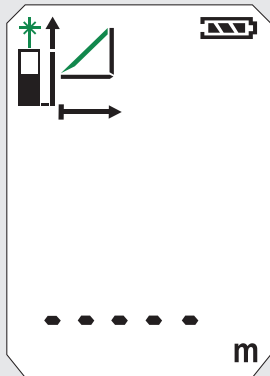
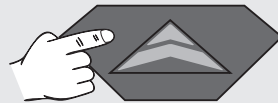

INDIREKT MÄTNING (PYTHAGORAS 2)

0



1

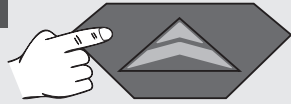

2

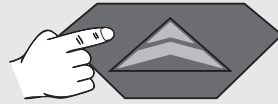

3

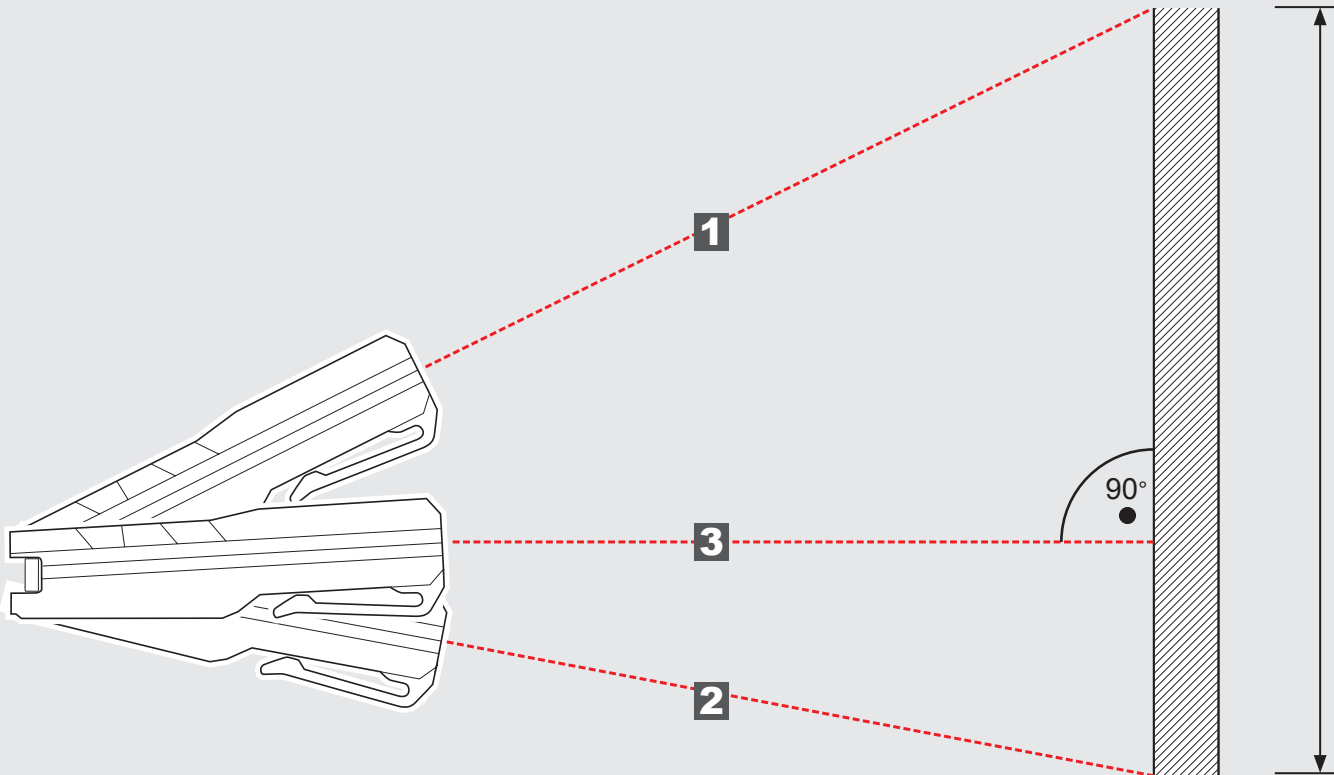
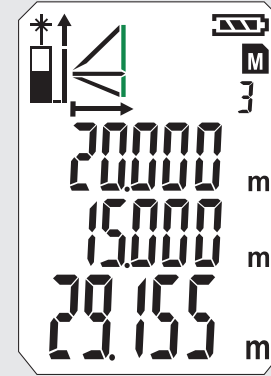
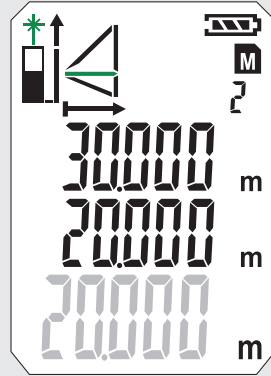
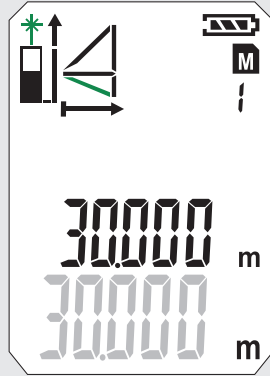
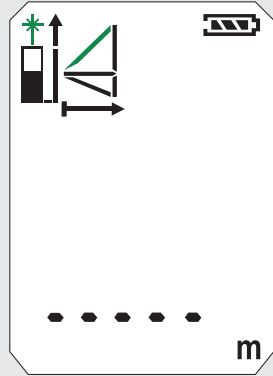
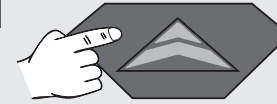

INDIREKT MÄTNING (PYTHAGORAS 3)

1



2

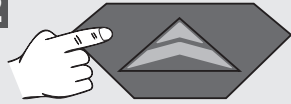



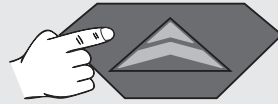

3

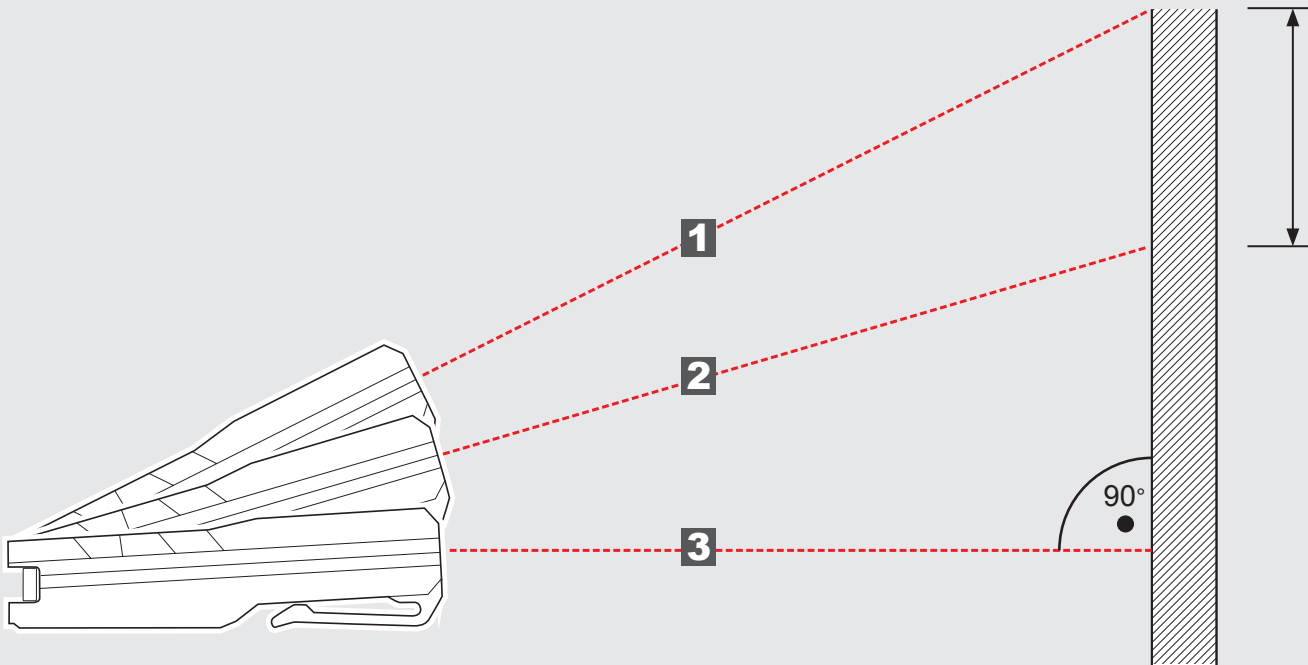
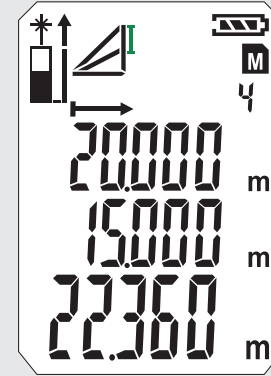
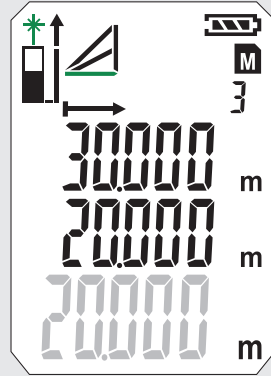
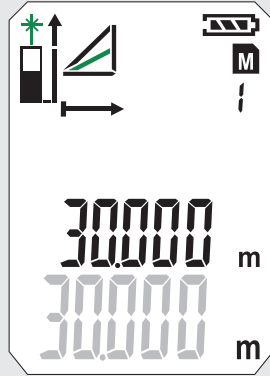
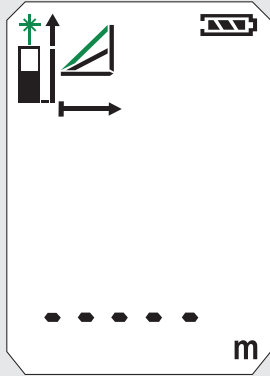
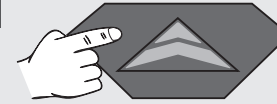

4

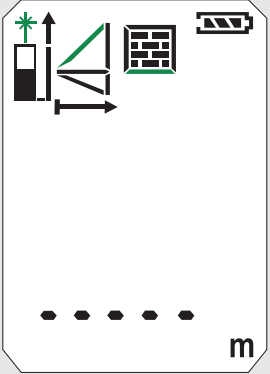
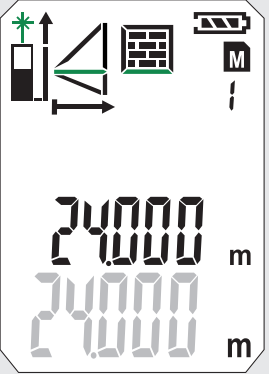
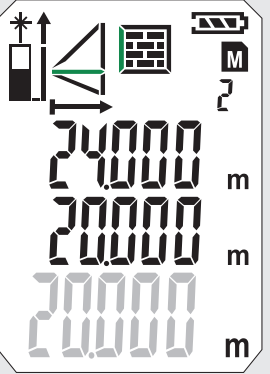
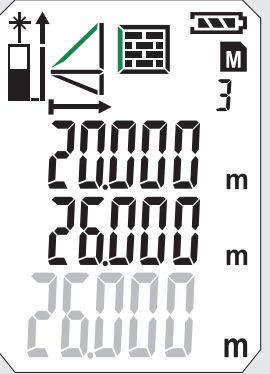
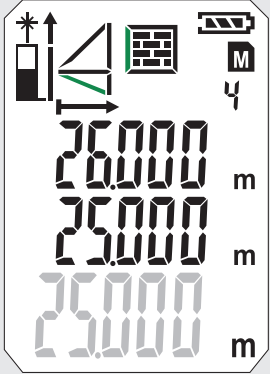

MÄTNING VÄGGAREA (SCENARIO 1)

0 	1 	2 	3 	4 
				

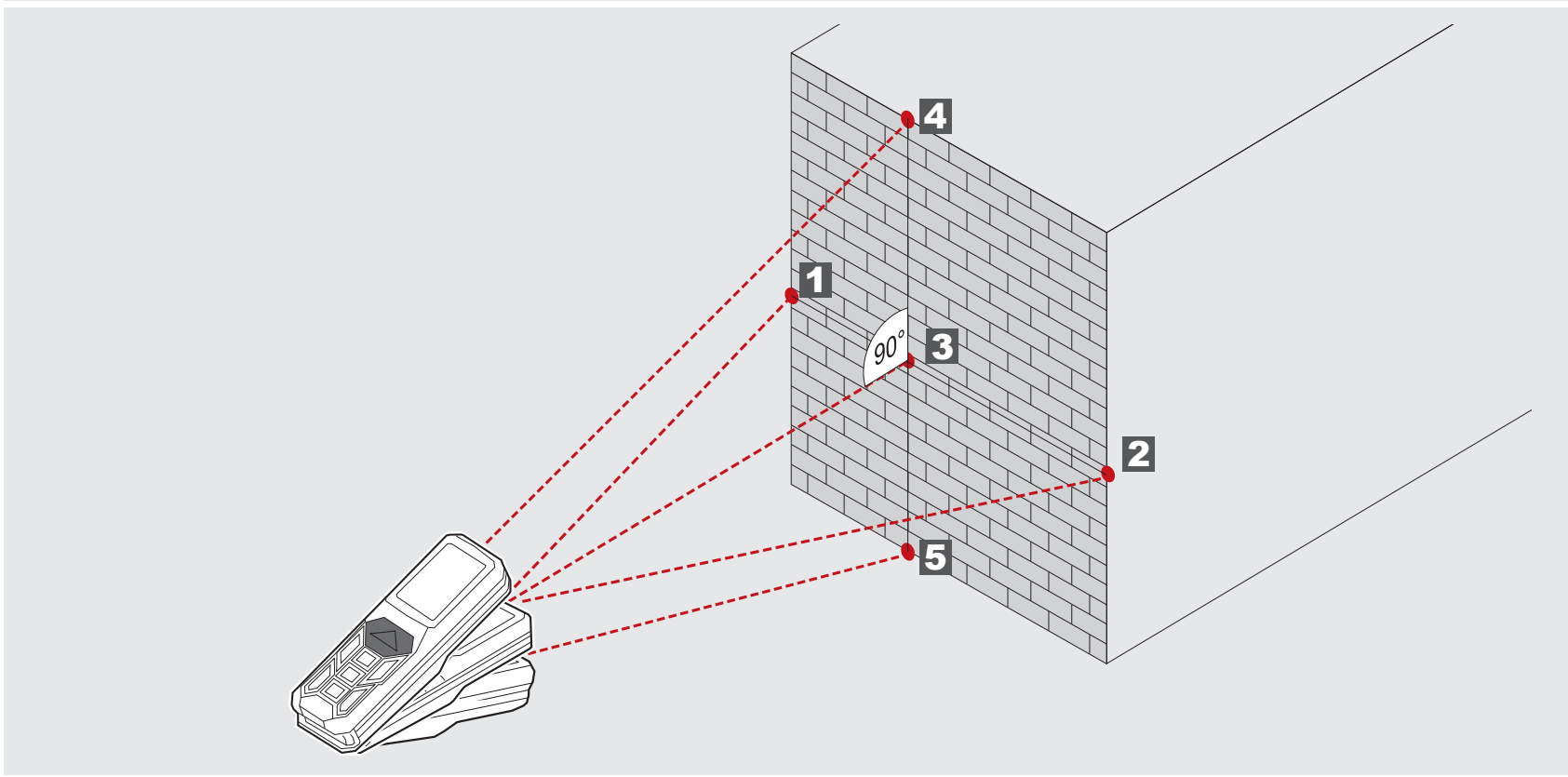





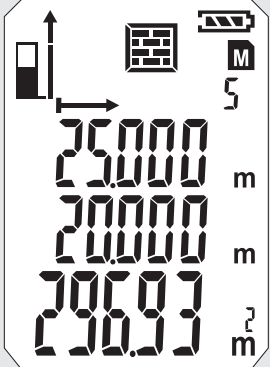





5





MÄTNING VÄGGAREA (SCENARIO 2)

0 	1 	2 	3 	4 
				

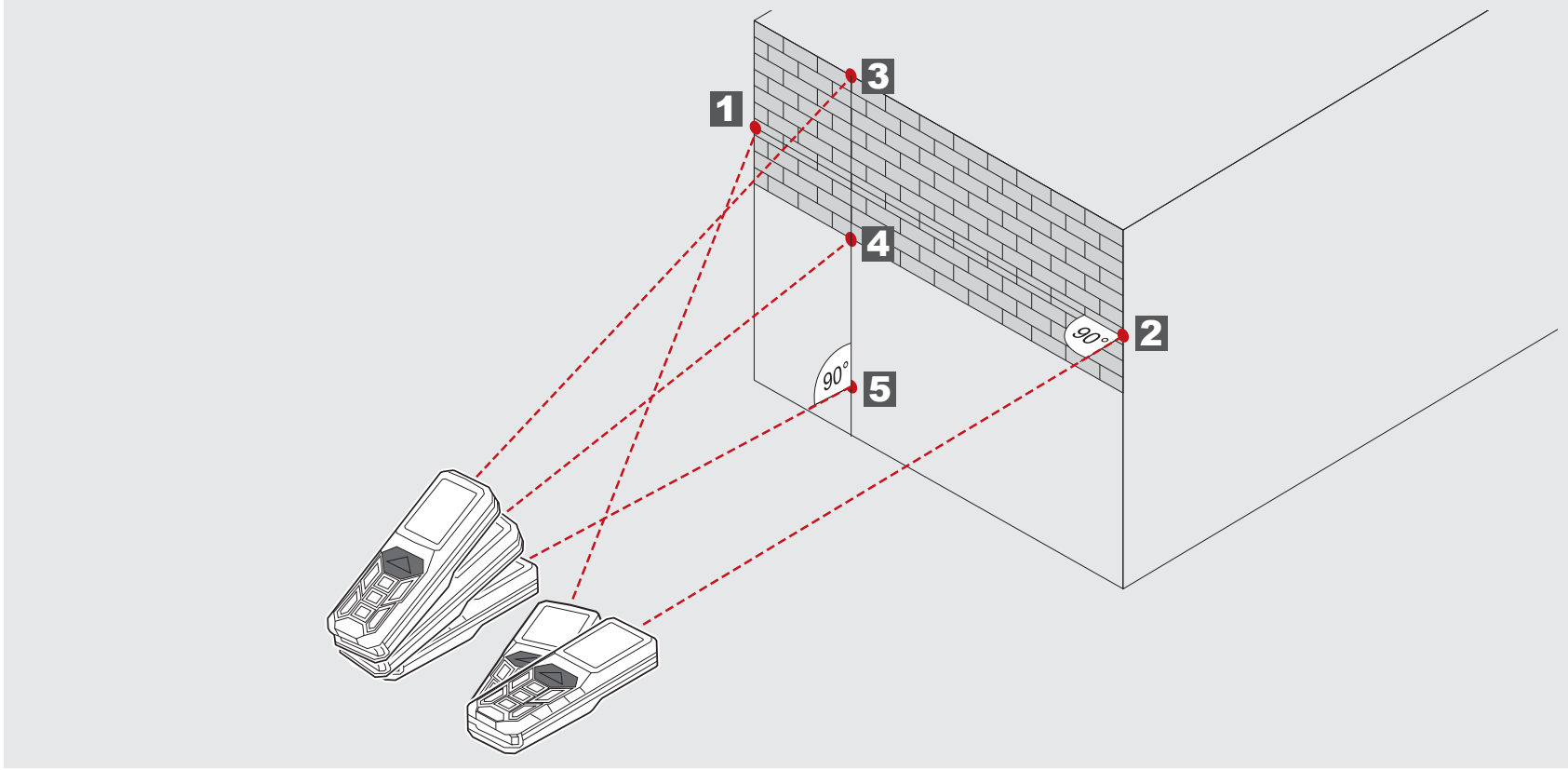

5



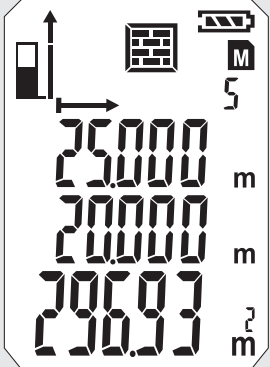

TIMER

Med timern kan mätningen utlösas tidsfördröjt för att t.ex. placera en byggnadsdel i mätstrålen.

Tryck på knappen .

- Symbol visas
- Genom att man trycker på knappen  kan timern ställas in på mellan 3 och 15 sek.

Tryck på knappen .

- Sekunderna räknas ner till mätningen.
- Vid 0 utförs mätningen.

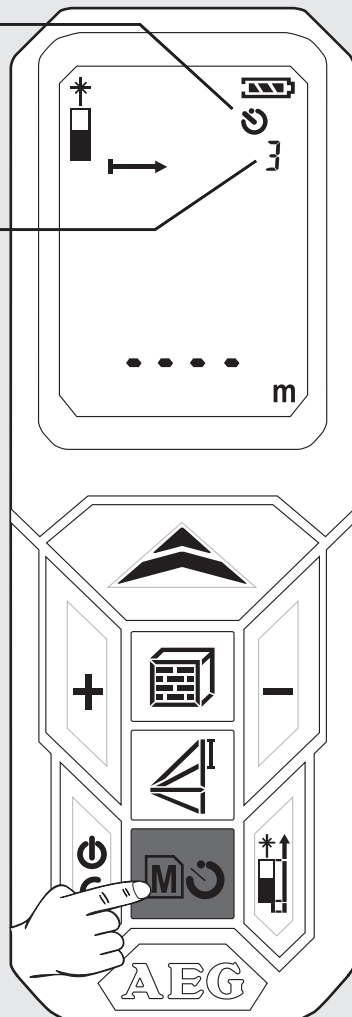

MINNE

Mätvärdena sparas automatiskt fortlöpande i minnet.

De sparade värdena kan hämtas med knappen .

Tryck på knappen  under 2 sek

- Symbol och minnesplats visas.
- Tillhörande mätstorlek visas.
- Det sparade värdet visas på huvudraden.
- Navigera med +/- knapparna

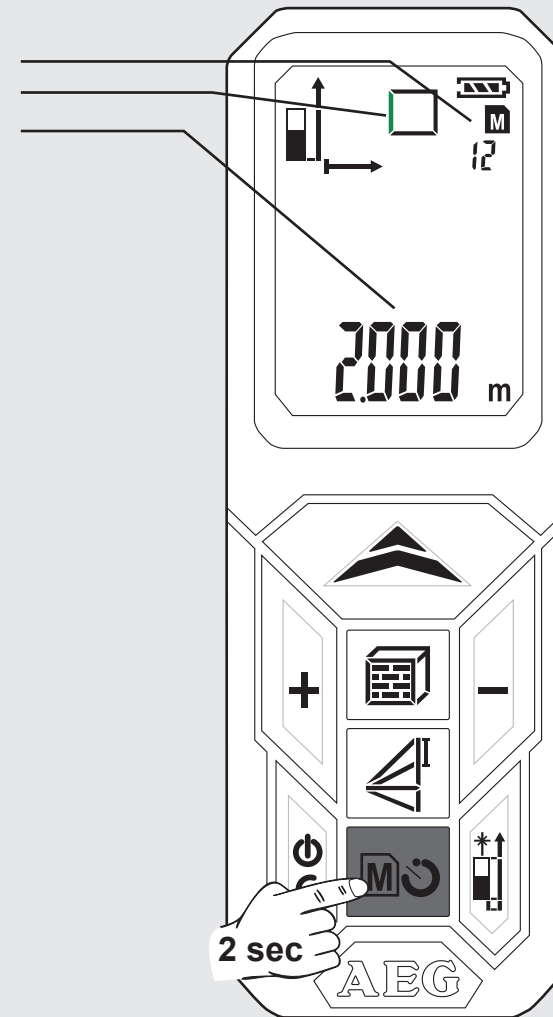

GRUNDLÄGGANDE FUNKTIONSSÄTT BESKRIVET MED EN AREAMÄTNING SOM EXEMPEL (1)

1 Start



Tryck på knappen 

⚠ OBS! Laserstrålen är påslagen!
Rikta inte mot personer!

Lasersymbolen blinkar
(blinkljuset visas här grönt).

2 Välj mätnivå

Standardinställning efter påslagning: baktill

 Tryck 1x -> hörnpinne
 Tryck 2x -> framtill
 Tryck 3x -> baktill

Symbol visas

3 Välj funktion

Efter att instrumentet slås på står det alltid på längdmätning.

 Tryck 1x - areamätning

- Symbol visas
- Mätstorlek blinkar
(blinkljuset visas här grönt).

4 Mäta längd

Rikta in instrumentet och tryck på knappen 

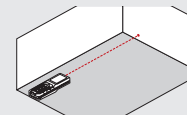

- Mätvärdet visas kort på huvudraden.
- Mätvärdet hoppar efter 1 sek till raden ovanför.
Mätvärdet sparas i minnet under det fortlöpande numret.
Den andra mätstorleken blinkar. Instrumentet är redo för mätning av det andra värdet.

5 Mäta bredd

Rikta in instrumentet och tryck på knappen 

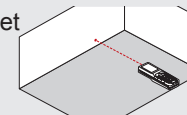

- Mätvärdet visas kort på huvudraden.
- Mätvärdet hoppar efter 1 sek till raden ovanför.
Mätvärdet sparas i minnet under det fortlöpande numret.
- Resultatet visas på huvudraden och sparas i minnet under det fortlöpande numret.

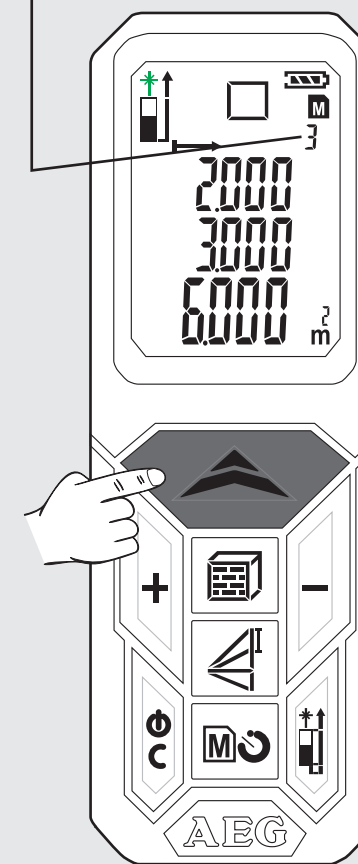
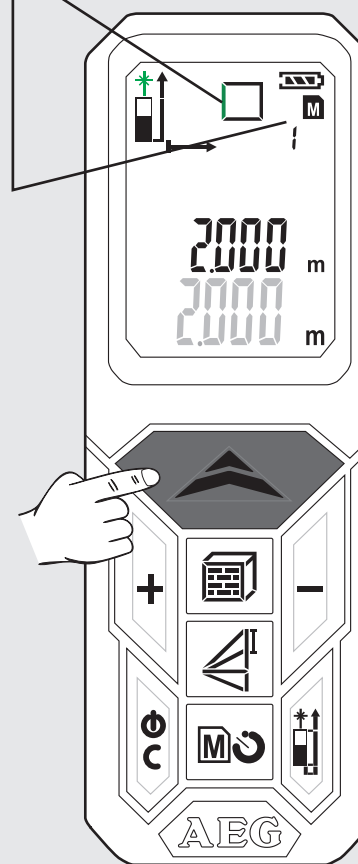
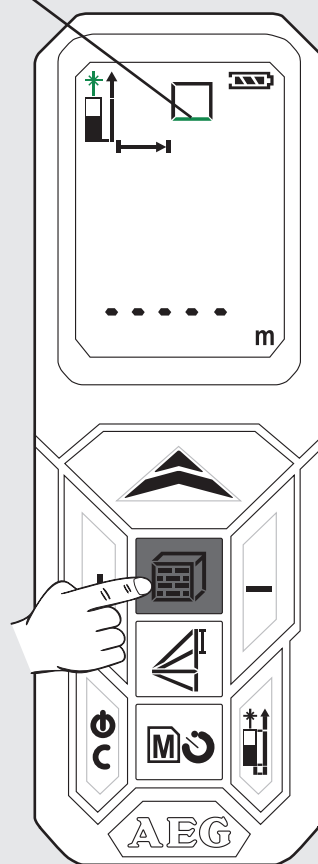
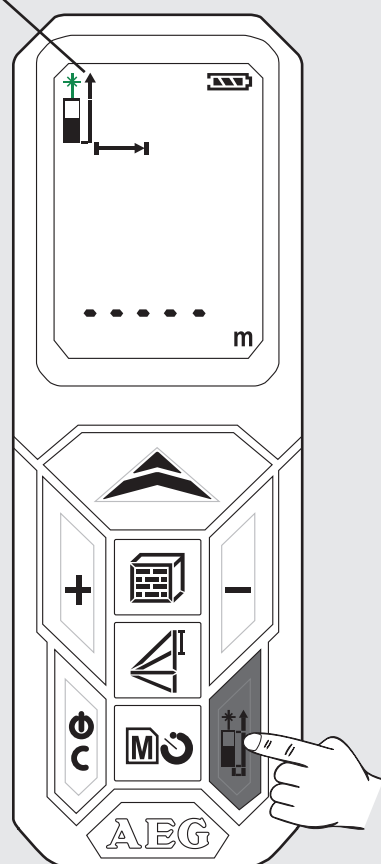
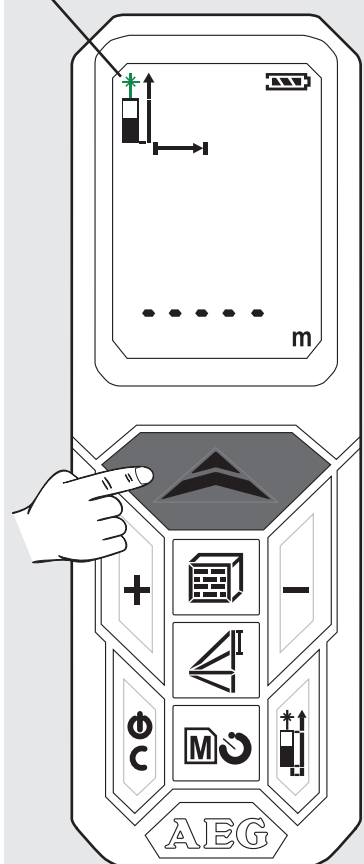

GRUNDLÄGGANDE FUNKTIONSSÄTT BESKRIVET MED EN AREAMÄTNING SOM EXEMPEL (2)

6 Hämta sparade värden

Tryck på knappen  under 2 sek.

Tryck på knappen + eller -

- De sparade värdena visas på huvudraden.

- Den tillhörande symbolen visas och mätstorleken blinkar (blinkljuset visas här grönt).

7 Stänga minnet

Tryck på knappen .

8 Stänga av

Tryck på knappen  under 2 sek (minnet måste stängas först).

- Instrumentet stängs av.

- Om ingen knapp tryck in under 3 sek stängs instrumentet av automatiskt.

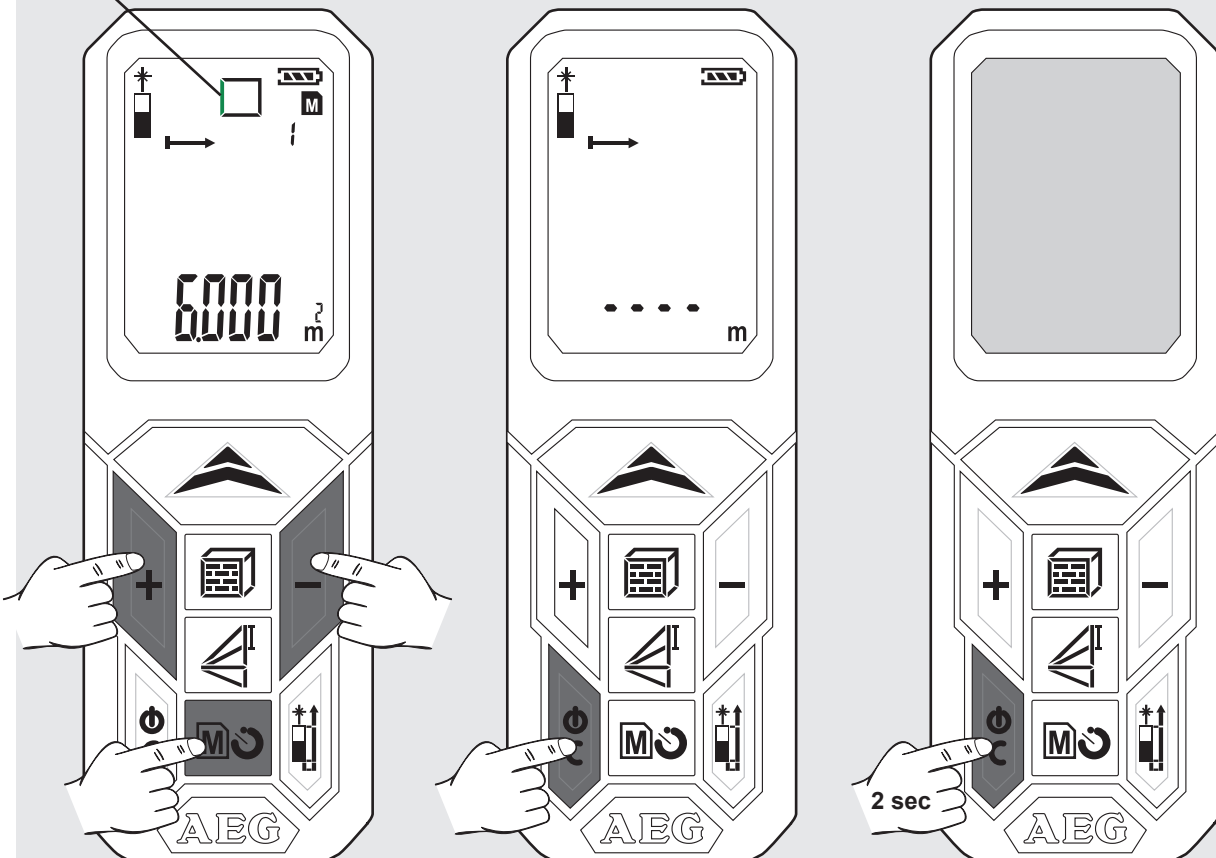

SISÄLTÖ

Tärkeitä turvallisuusohjeita.....	1
Tekniset arvot	2
Tarkoituksenmukainen käyttö	2
Virhekooditaulukko	2
Yleiskuva	3
Paristojen vaihtaminen	4
Nurkkapuikko.....	4
Vyökannatin.....	4
Toimintonäppäin, Pythagoras, mittaustaso.....	5
Yksinkertainen pituusmittaus.....	6
Jatkuva mittaus / minimi-maksimi-mittaus	7
Lisäys- / vähennysmittaus	8
Pinta-alamittaus.....	9
Tilavuusmittaus.....	10
Epäsuora mittaus (Pythagoras 1).....	11
Epäsuora mittaus (Pythagoras 2).....	12
Epäsuora mittaus (Pythagoras 3).....	13
Seinän pinta-alamittaus (malli 1).....	14
Seinän pinta-alamittaus (malli 2).....	15
Ajastin.....	16
Muisti	16
Perusluontoinen toimintatapa pinta-alamittauksen (1) esimerkillä näytettynä.....	17
Perusluontoinen toimintatapa pinta-alamittauksen (2) esimerkillä näytettynä.....	18

TÄRKEITÄ TURVALLISUUSOHJEITA



Älä käytä tuotetta ennen kuin olet tutkinut Turvallisuusohjeet ja Käyttäjän käsikirjan oikealta CD-levyltä.

Laserluokka

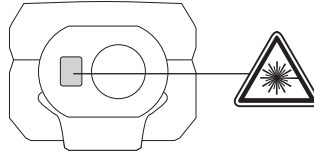

VAROITUS:

Se on Luokan 2 laser-tuote normin IEC 60825-1:2007 mukaan.



Tekstitys

Liimaa ennen ensimmäistä käyttöönottoa mukana toimitettu maasi kielinen tarra laitteen tyyppikilven englanninkielisen tekstin päälle.

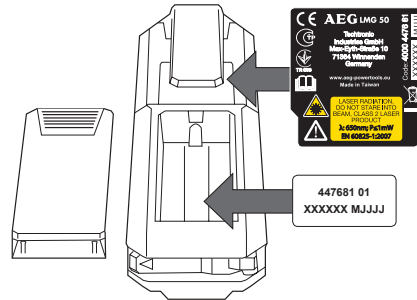

Varoitus:

Vältä katsomasta suoraan laseriin. Lasersäde saattaa häikäistä silmät salaman tavoin ja aiheuttaa ohimenevän sokaistumisen.

Älä katso suoraan lasersäteeseen, äläkä suuntaa sitä tarpeettomasti kohti muita ihmisiä.

Älä tähtää muihin henkilöihin.

Varoitus:

Älä käytä laserlaitetta lasten lähettyvillä äläkä anna lasten käyttää laserlaitetta.

Huomio! Heijastava pinta saattaisi heijastaa lasersäteen takaisin käyttäjään tai muihin henkilöihin.

Pida raajat turvallisen matkan päässä liikkuvista osista.

Suorita säännöllisesti koemittauksia. Erityisesti ennen, aikana ja tärkeiden mittausten jälkeen.

Tarkkaile virheellisiä mittauksia, jos tuote on viallinen, tai se on pudonnut, tai sitä on väärinkäytetty tai muutettu.

Huom! Tutustu puutarhalaitteen käyttöelementteihin ja asianmukaiseen käyttöön.

Lasermittarin käyttöalue on rajoitettu. (Katso kohtaa "Tekniset tiedot"). Jos yrität mitata pienimmän tai suurimman alueen ulkopuolelta, niin tulokset ovat epätarkkoja. Jos laitetta käytetään vaikeissa olosuhteissa, kuten liian kuumassa, liian kylmässä, hyvin kirkkaassa auringonvalossa, sateessa, lumisateessa, sumussa tai muissa näkyvyyttä rajoittavissa olosuhteissa, niin mittaustulokset voivat olla epätarkkoja.

Kun tuot lasermittarin lämpimästä tilasta kylmään tilaan (tai päinvastoin), odota, kunnes laite on sopeutunut ympäristön muuttuneeseen lämpötilaan.

Säilytä lasermittaria aina sisätiloissa ja suojaa laitetta iskuilta, tärinältä tai äärimmäisiltä lämpötiloilta.

Suoja lasermittaria pölyltä, kosteudelta ja suurelta ilmankosteudelta. Se saattaa tuhota laitteen sisäiset osat tai vaikuttaa sen tarkkuuteen.

Älä käytä mitään syövyttäviä puhdistusaineita tai liuotteita. Puhdista laite vain puhtaalla, pehmeällä rievulla.

Vältä lasermittariin kohdistuvia iskuja tai sen putoamista. Laitteen tarkkuus tulee tarkastaa, jos se on pudonnut tai siihen on kohdistunut muunlaista mekaanista rasitusta.

Vain valtuutettu ammattihenkilöstö saa suorittaa tämän laserlaitteen tarvittavat korjaustyöt.

Älä käytä tuotetta räjähdysvaarallisilla alueilla tai aggressiivisissa ympäristöissä.

KKäytä vain valmistajan suosittelemia latureita akkujen lataamiseen.



Tyhjiä paristoja ei saa hävittää talousjätteen mukana.

Huolehdi ympäristöstä ja vie ne kansallisten ja paikallisten säännösten mukaisesti järjestettyihin keräyspisteisiin. Tuotetta ei saa hävittää kotitalousjätteen mukana. Hävitä laite asianmukaisesti maassasi voimassa olevien säädösten mukaisesti. Noudata kansallisia ja maakontaaisia määräyksiä. Ota yhteyttä paikallisiin viranomaisiin tai kauppiaseesi saadaksesi tietoa hävittämisestä.



CE-merkki

TEKNISET ARVOT

Suoja-luokka	IP54 (pöly- ja roiskevesisuoja)
Optiikka	14 mm
Polttopiste	35 mm
Mittausalue enint.	50 metriä (toleranssi: 55 m)
Mittausalue väh.	0,05 metriä
Absoluuttinen tarkkuus @ < 10 m	± 1,5 mm (max)
Toistotarkkuus @ < 10 m	± 1,5 mm (tyypillisesti enint. 2σ)
Toistotarkkuus @ > 10 m	nousu ± 0,25 mm / metri (tyypillisesti enint. 2σ)
Mittausaika	0,5 s
Näyttötyyppi	LCD (22,7 mm x 31 mm)
Virransyöttö	AAA 2x (alkaline-paristo)
Pariston kesto-aika	10000 (yksittäismittausta)
Laserin lähtöteho	0,6 mW ~ 0,95 mW (luokka 2, 650 nm)
Laserpisteen koko	25 x 30 mm @ 16 m (max)
Lasersäteen pystyakseli	+1 aste
Lasersäteen vaakakulma	1 aste
Automaattinen laitteen sammutus	180 sekuntia
Automaattinen laserin sammutus	30 sekuntia
Työlämpötila-alue	-10°C - +50°C
Säilytyslämpötila-alue	-10°C - +70°C
Paino ilman paristoa	80 g

TARKOITUKSEN MUKAINEN KÄYTTÖ

Lasermittaria voidaan käyttää etäisyyksien ja kaltevuuksien mittaamiseen.

Älä käytä tuotetta ohjeiden vastaisesti.

VIRHEKOODITAU LUKKO

Koodi	Kuvaus	Poisto
Err01	Mittausalueen ulkopuolella	Suorita mittaus sille määrättyllä alueella.
Err02	Heijastettu signaali on liian heikko	Valitse sopivampi pinta.
Err03	Näyttöalueen ulkopuolella (suurin arvo: 99.999) esim. pinta-alan tai tilavuuden tulos on näyttöalueen ulkopuolella	Tarkasta, ovatko arvot ja vaiheet oikein.
Err04	Virhe Pythagoras-laskelmassa	Tarkasta, ovatko arvot ja vaiheet oikein.
Err05	Paristo heikko	Pane uudet paristot laitteeseen.
Err06	Työlämpötila-alueen ulkopuolella	suorita mittaus sille määrättyllä työlämpötila-alueella.
Err07	Ympäristö liian valoisa	Tummenna kohdealue.

Pythagoras
Korkeusero

Mittaustaso

Pituuden mittaus

Jatkuvan mittauksen minimi / maksimi

Lisäys / Vähennys

PÄÄLLE / MITTAUS

- ▶ Päälle
- ▶ Mittaus
- ▶ Jatkuva mittaus (paina 2 sek.)
Min.-/max.-toiminto

YHTEENLASKU

- ▶ Lisää arvo
- ▶ Liikkuminen muistissa

PINTA-ALA / TILAVUUS

- ▶ Pinta-ala (paina 1x)
- ▶ Tilavuus (paina 2x)
- ▶ Epäsuora pinta-alan mittaus (paina 3x / 4x)

KÄYNNISTYS

- ▶ Päälle
- ▶ Pois (paina 2 sek.)
- ▶ Takaisin

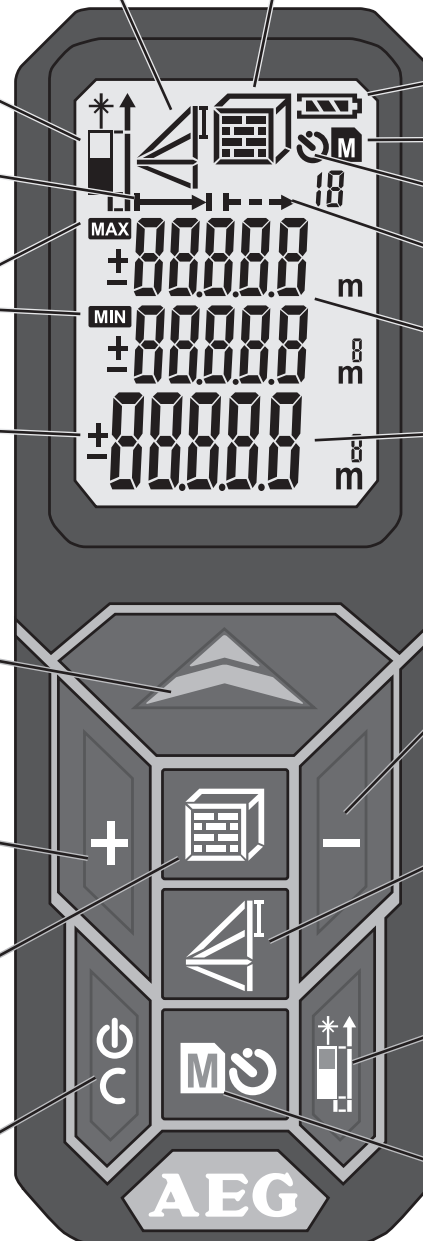

Pinta-ala / tilavuus
Epäsuora pinta-alan mittaus

Lataustila

Muisti

Ajastin

Jatkuva mittaus

Väliarvot

Kokonaisarvo

VÄHENNYS

- ▶ Vähennä arvo
- ▶ Liikkuminen muistissa

PYTHAGORAS

- ▶ Pythagoras 1 (paina 1x)
- ▶ Pythagoras 2 (paina 2x)
- ▶ Pythagoras 3 (paina 3x)

VAIHDA MITTAUSALUETTA

- ▶ Eteen
- ▶ Taakse
- ▶ Nurkkapuikko

MUISTI

- ▶ Ajastin 3-15 sek. (paina 1x)
- ▶ Muisti 1-20 (paina 1x 2 sek.)
- ▶ Liiku muistissa +/- näppäimillä

PARISTOJEN VAIHTAMINEN

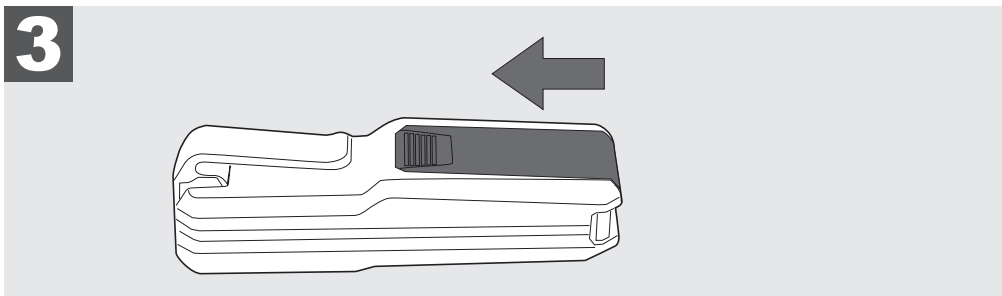
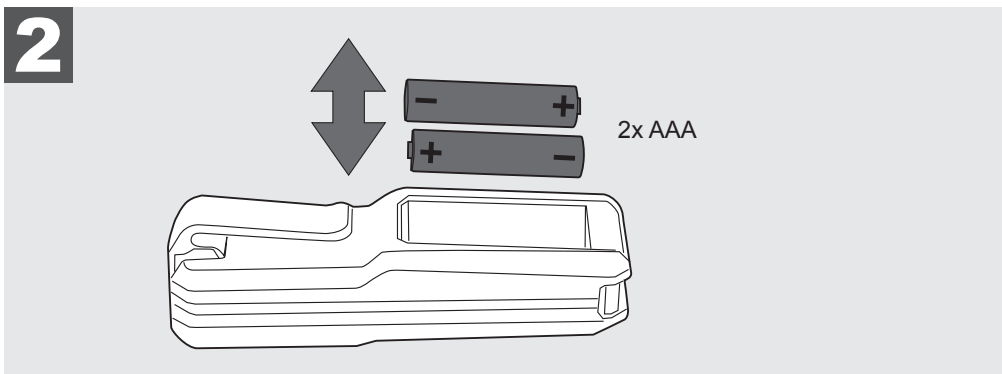
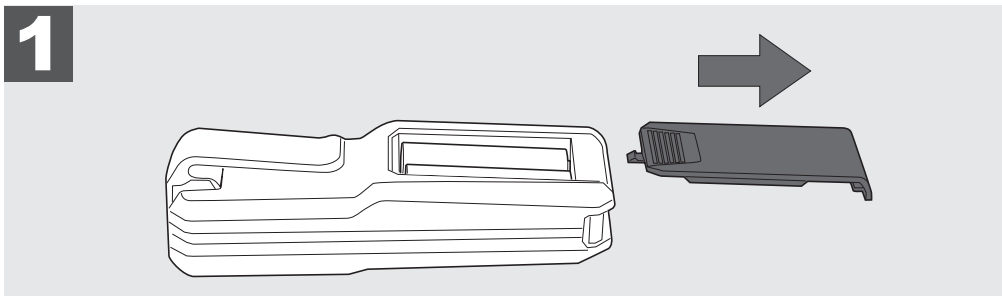
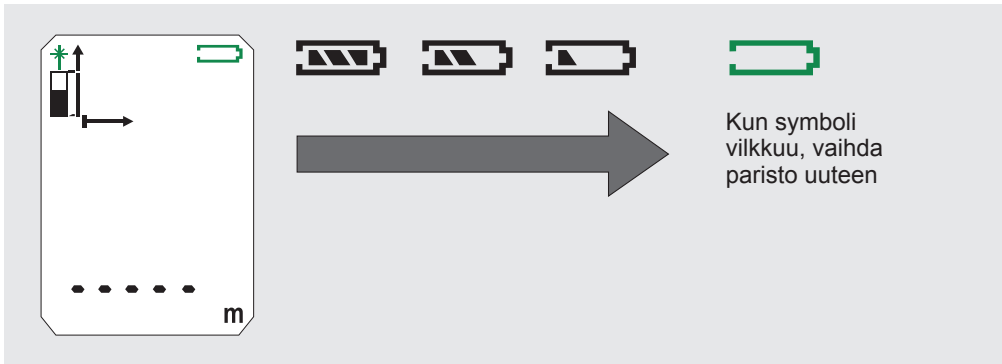

NURKKAPUIKKO

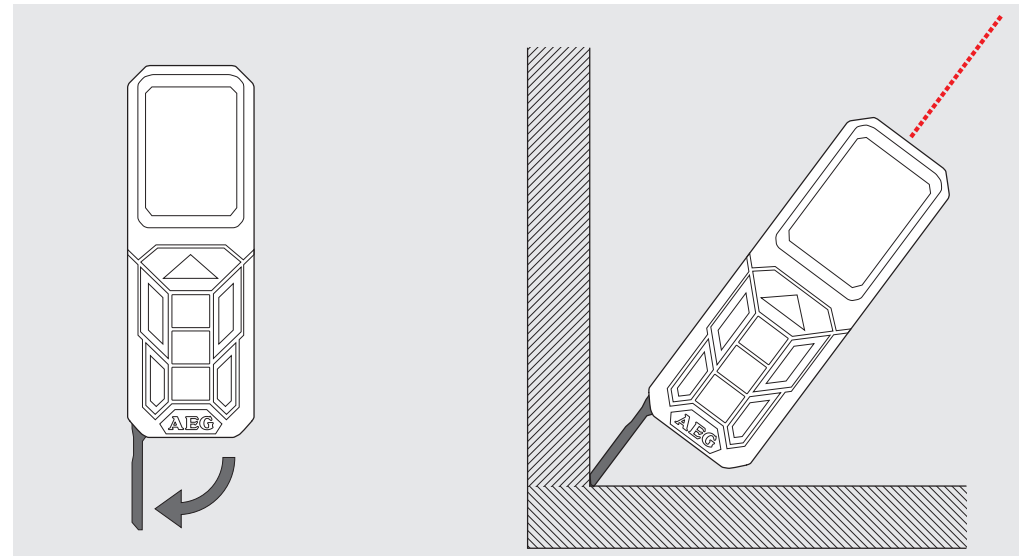

VYÖKANNATIN

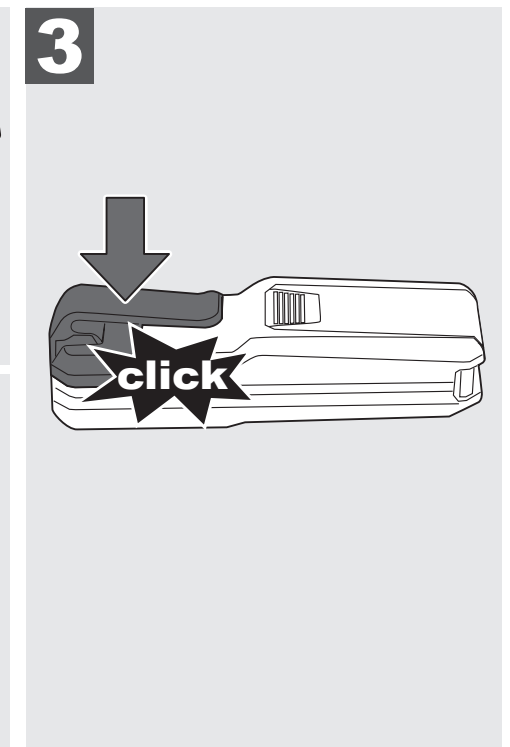
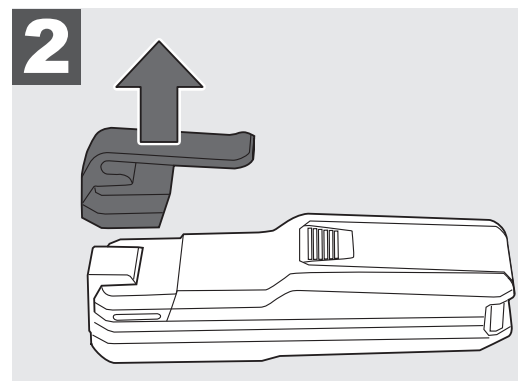
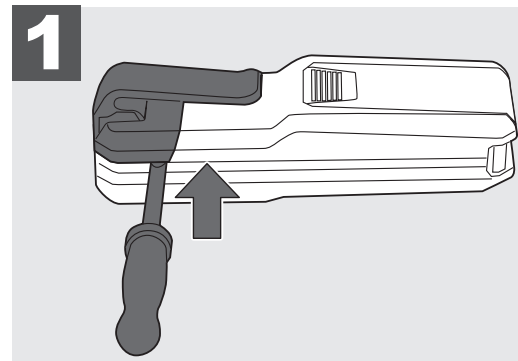

TOIMINTONÄPPÄIN, PYTHAGORAS, MITTAUSTASO

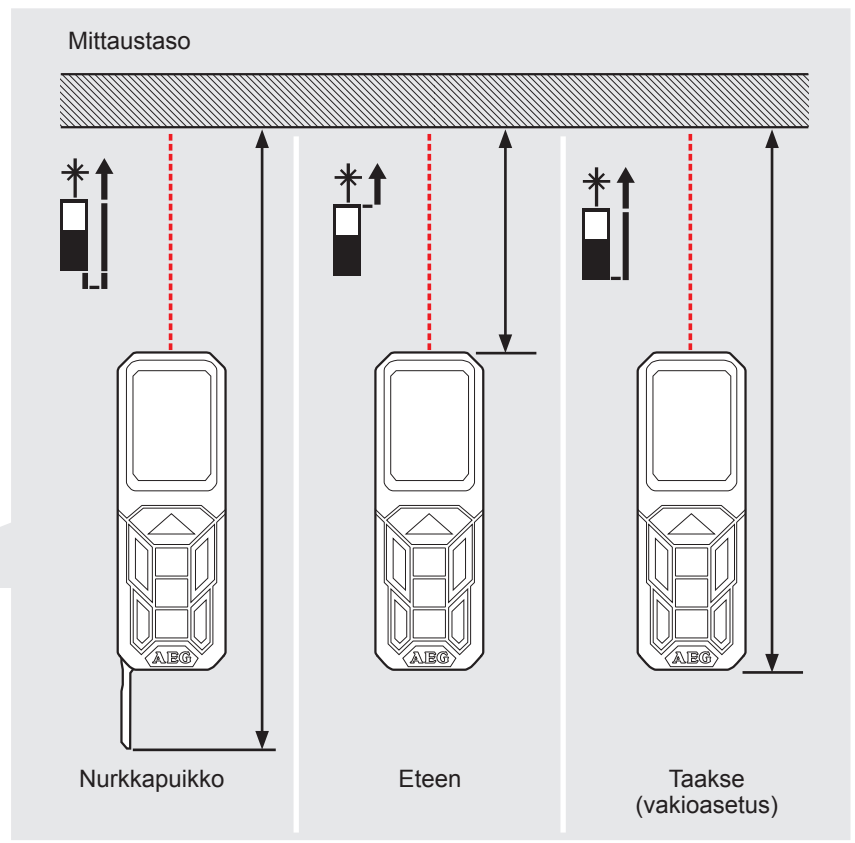
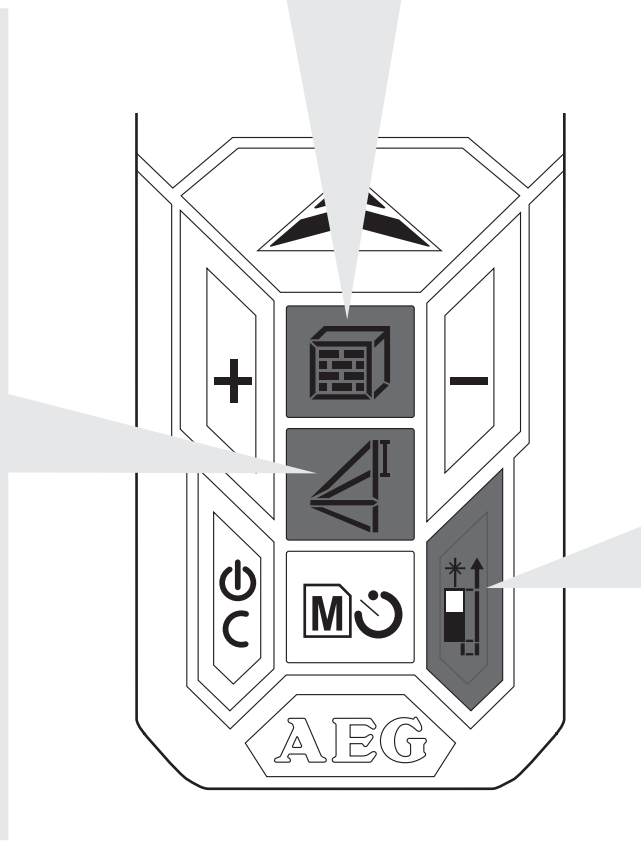
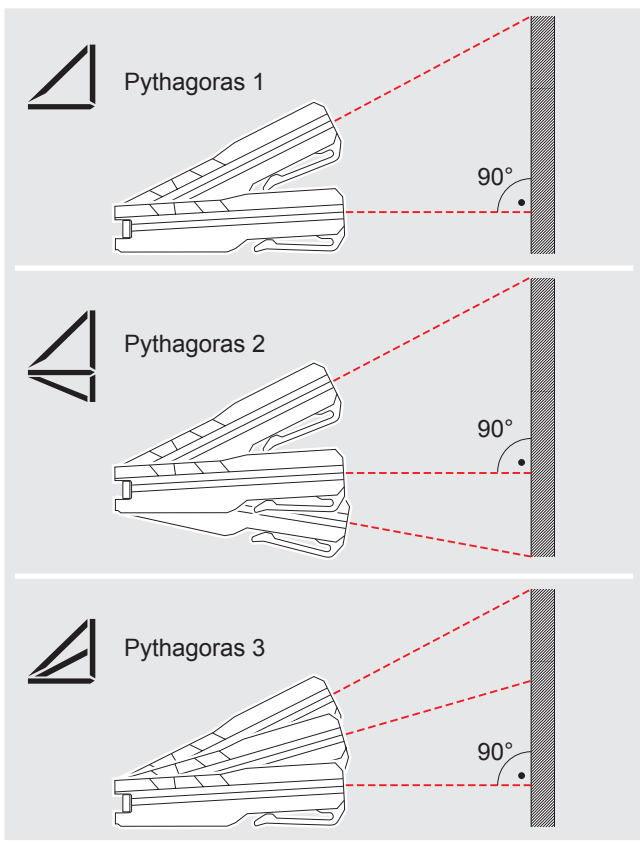
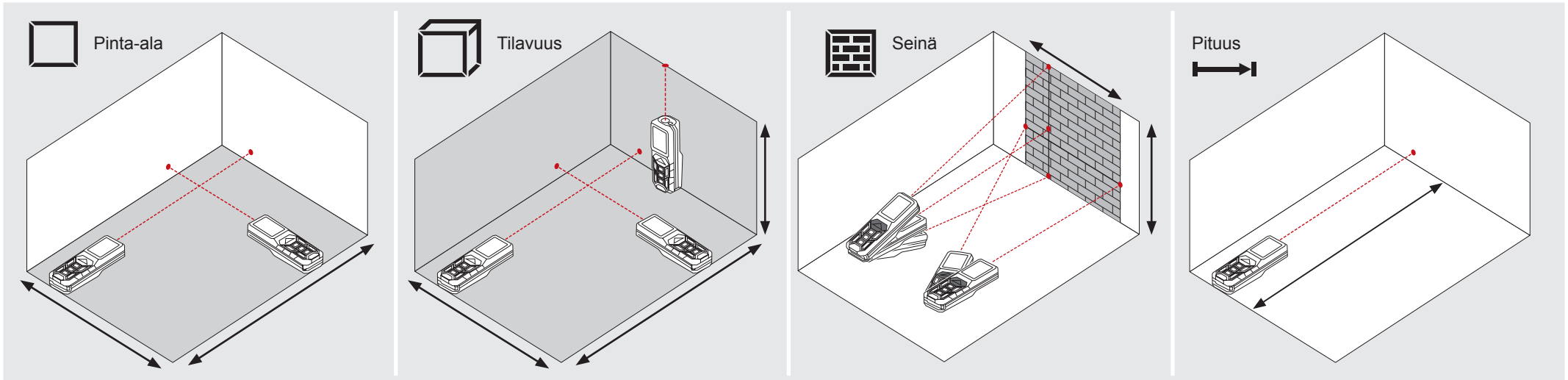

YKSINKERTAINEN PITUUSMITTAUS

0

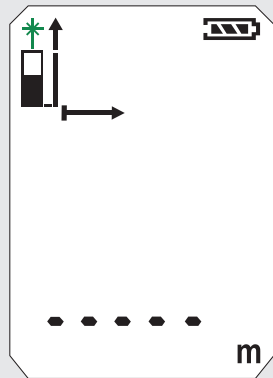

1

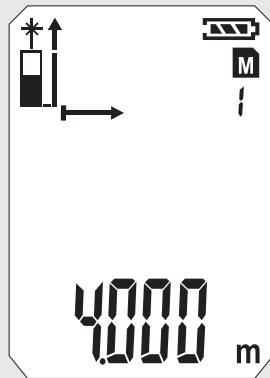
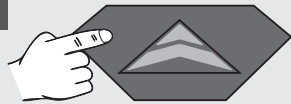

2

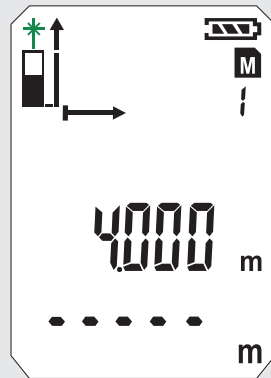
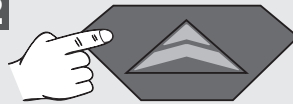

3

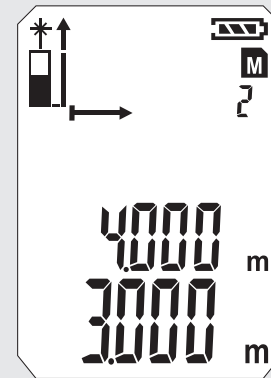
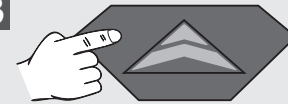

4

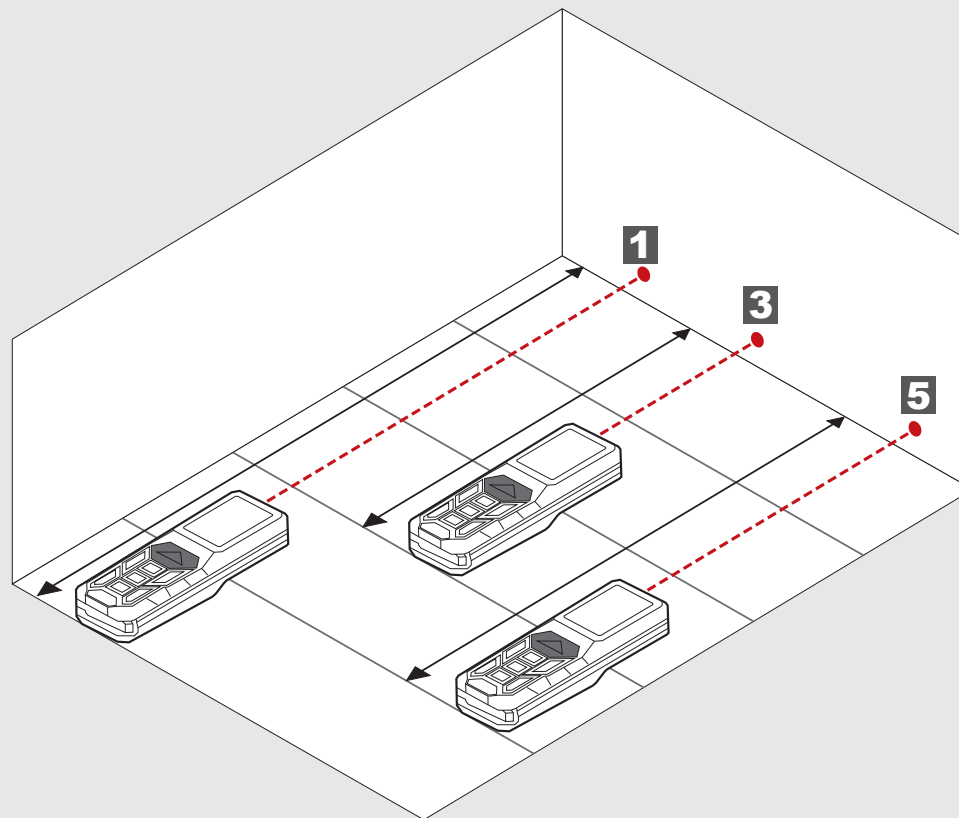
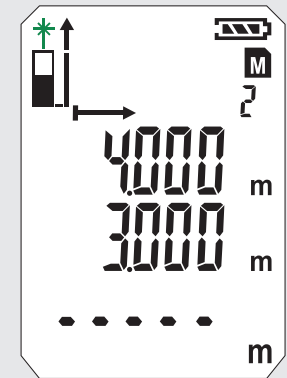
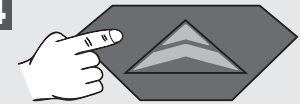

5

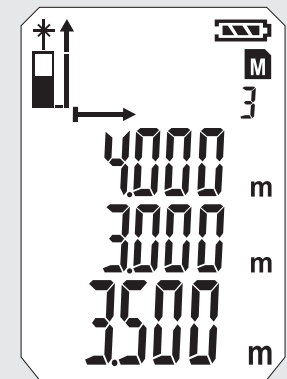
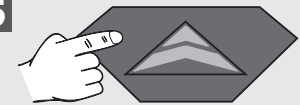

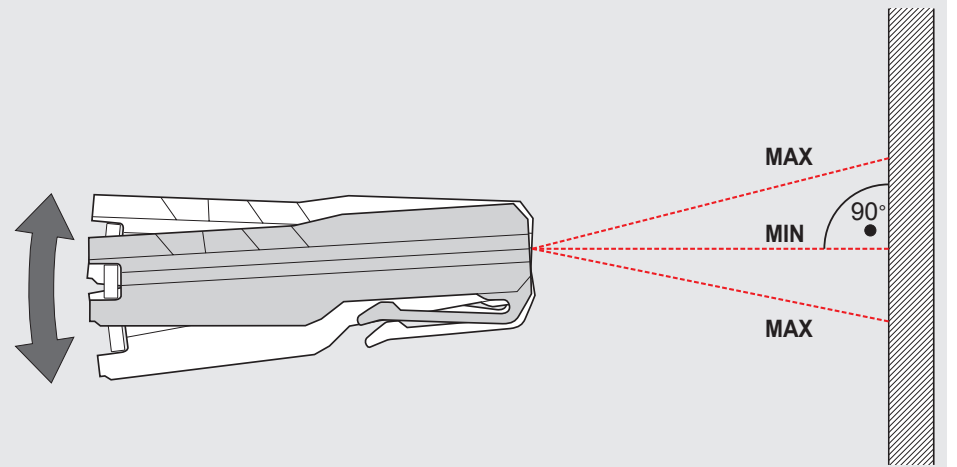
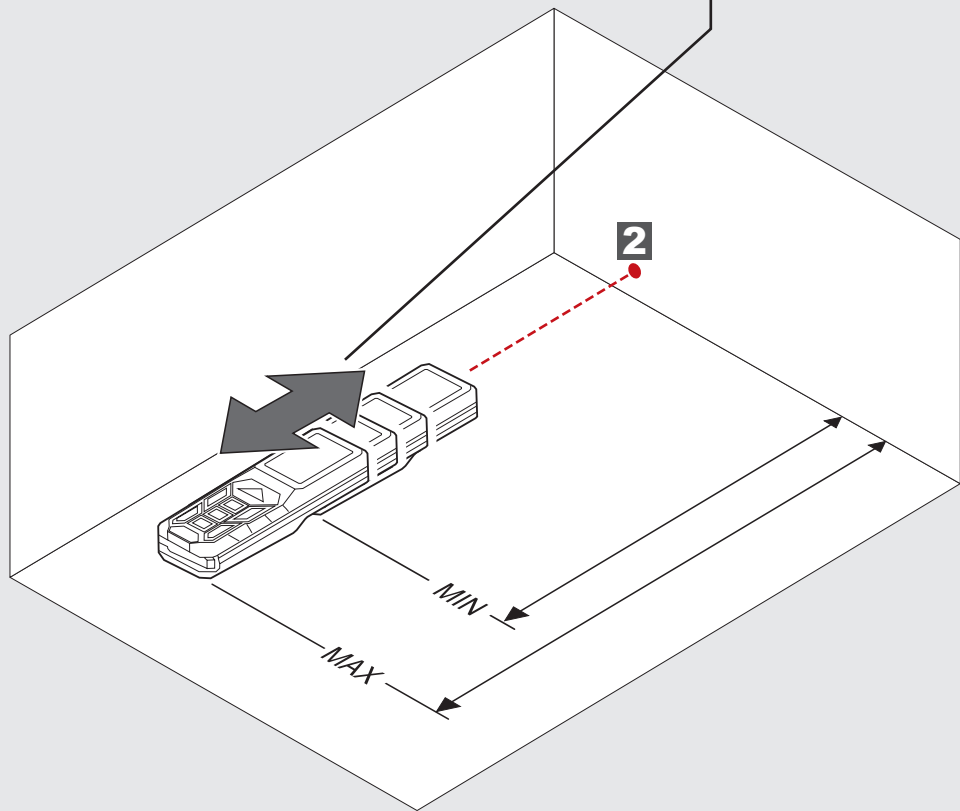
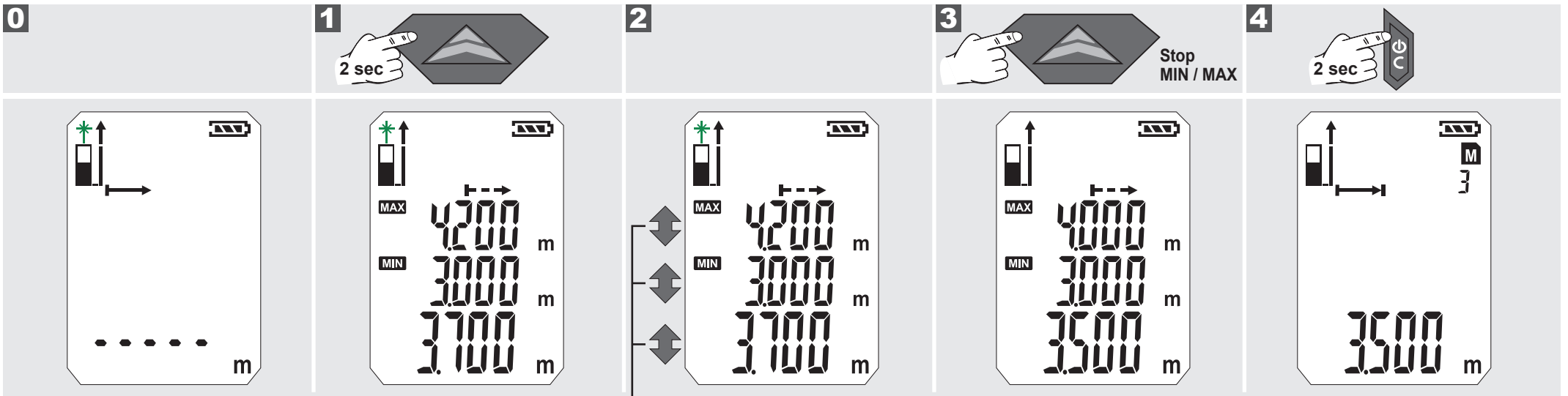

0

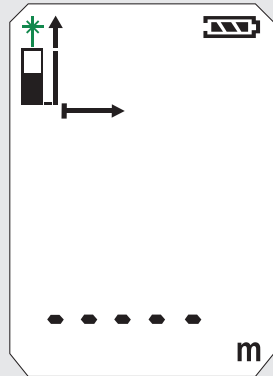

1

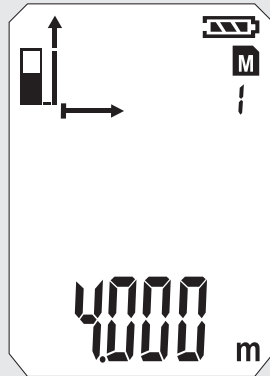
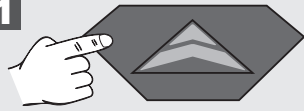

2

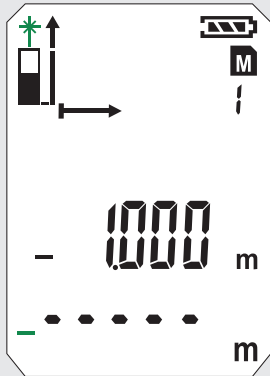
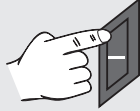

3

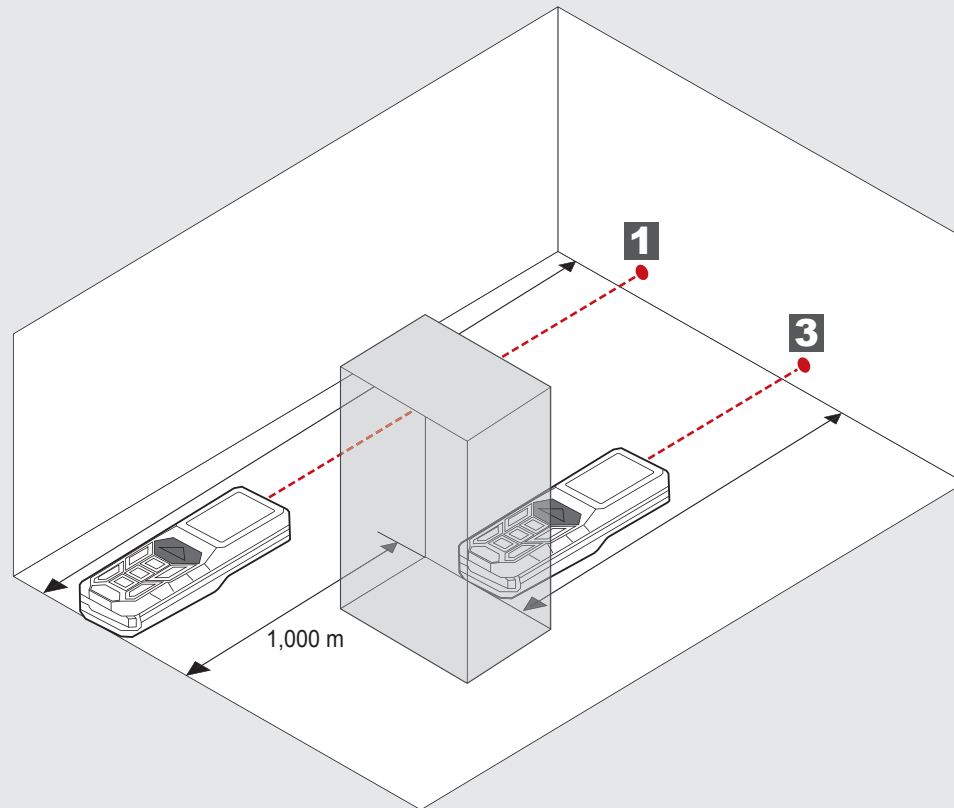
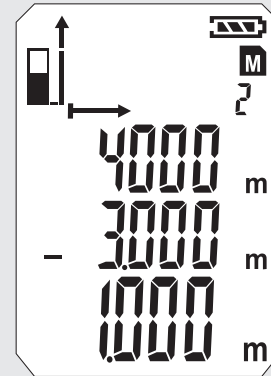
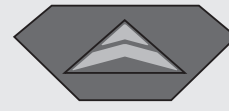

0



1x

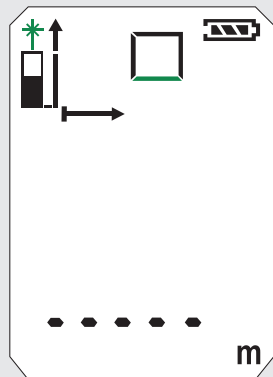

1

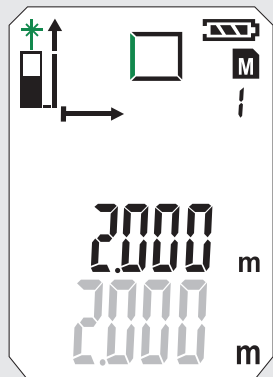
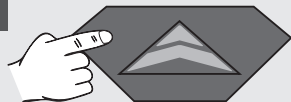

2

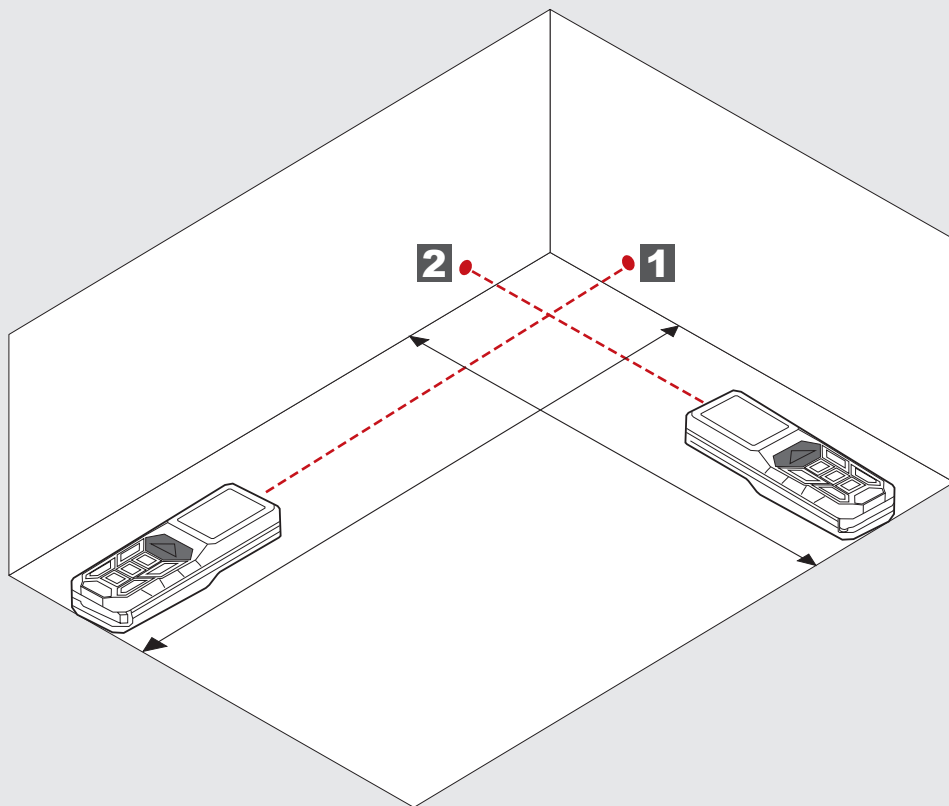
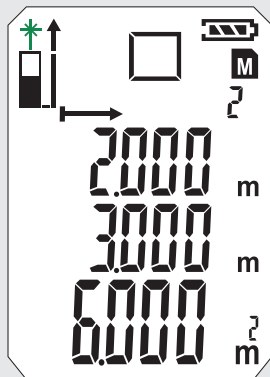
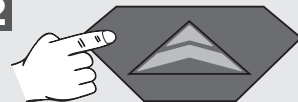

0



1

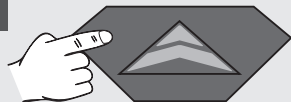

2

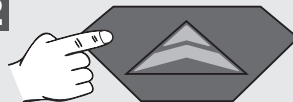

3

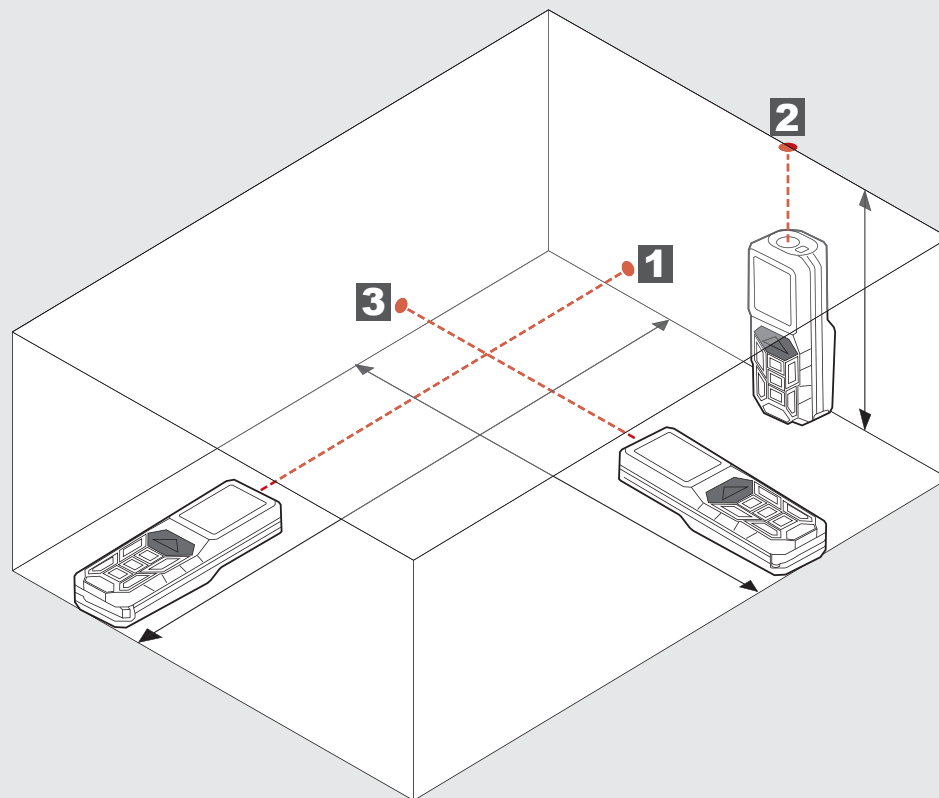
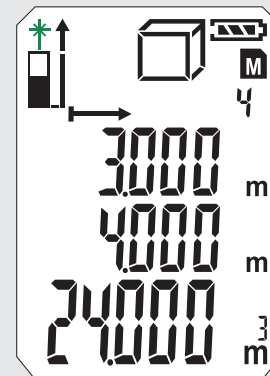
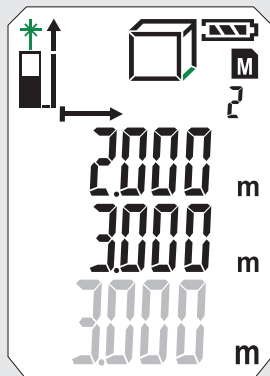
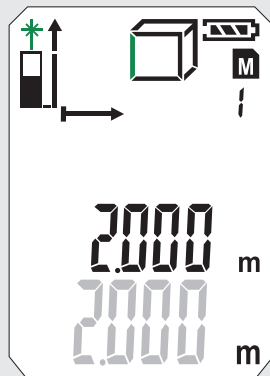
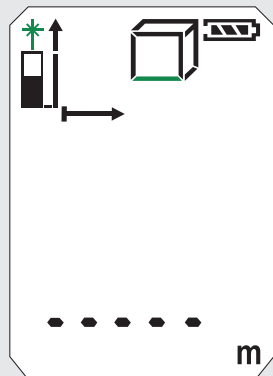
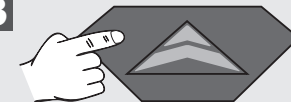

EPÄSUORA MITTAUS (PYTHAGORAS 1)

0





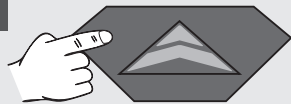

1

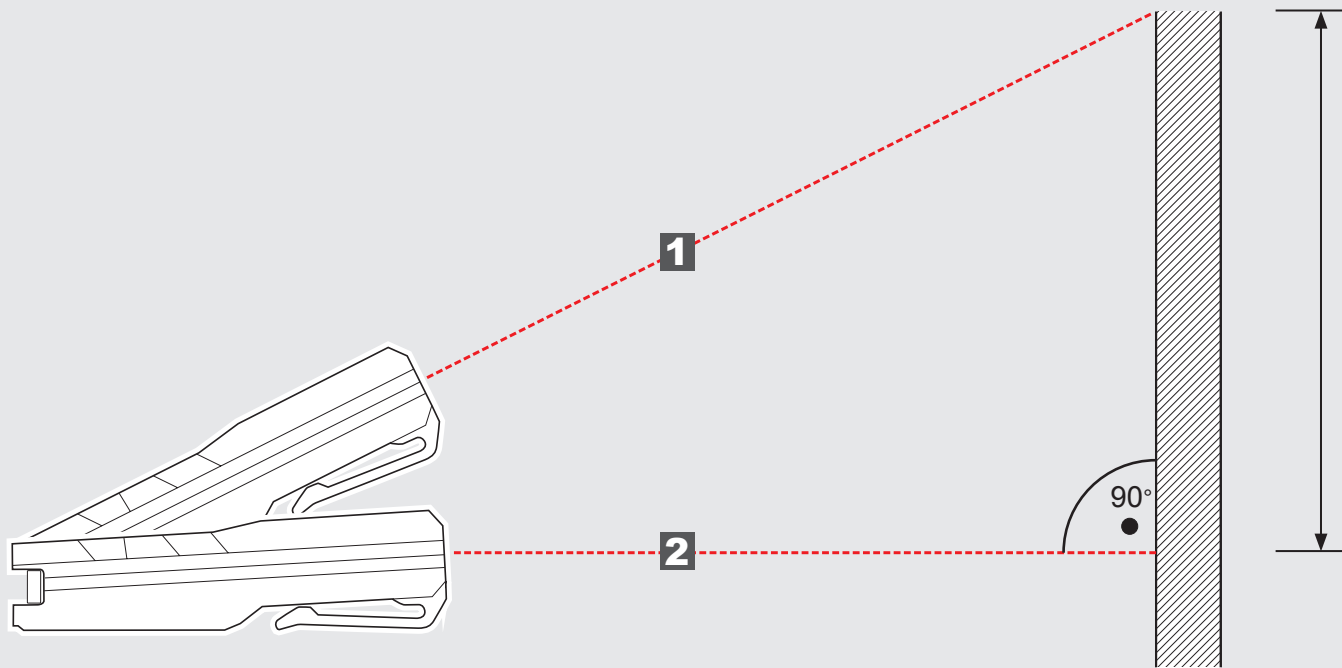
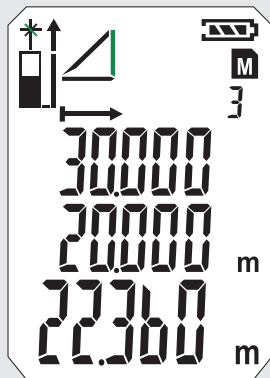
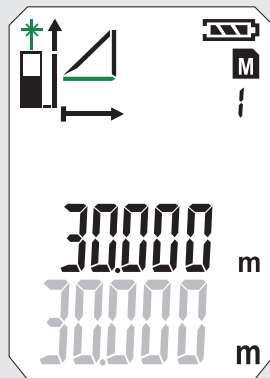
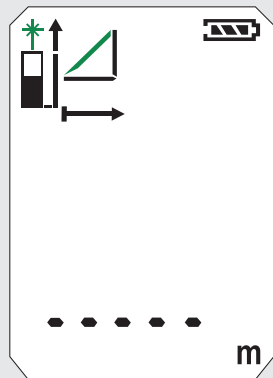
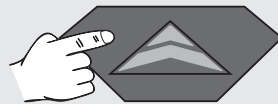

2

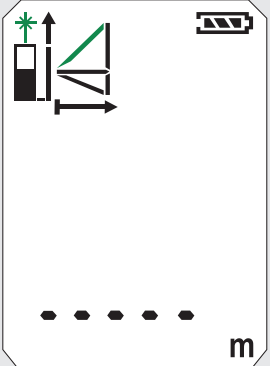
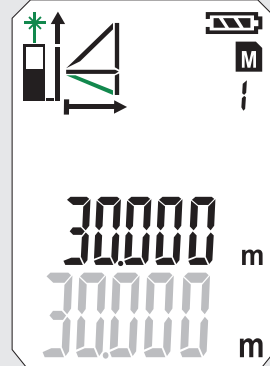
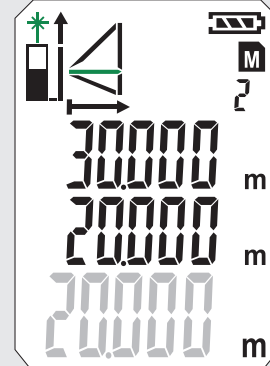
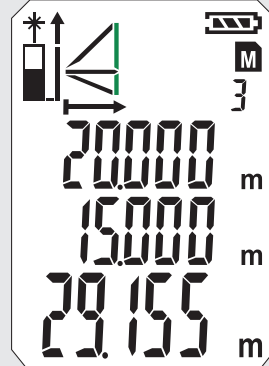

EPÄSUORA MITTAUS (PYTHAGORAS 2)

0  <p>2 x</p>	1 	2 	3 
			

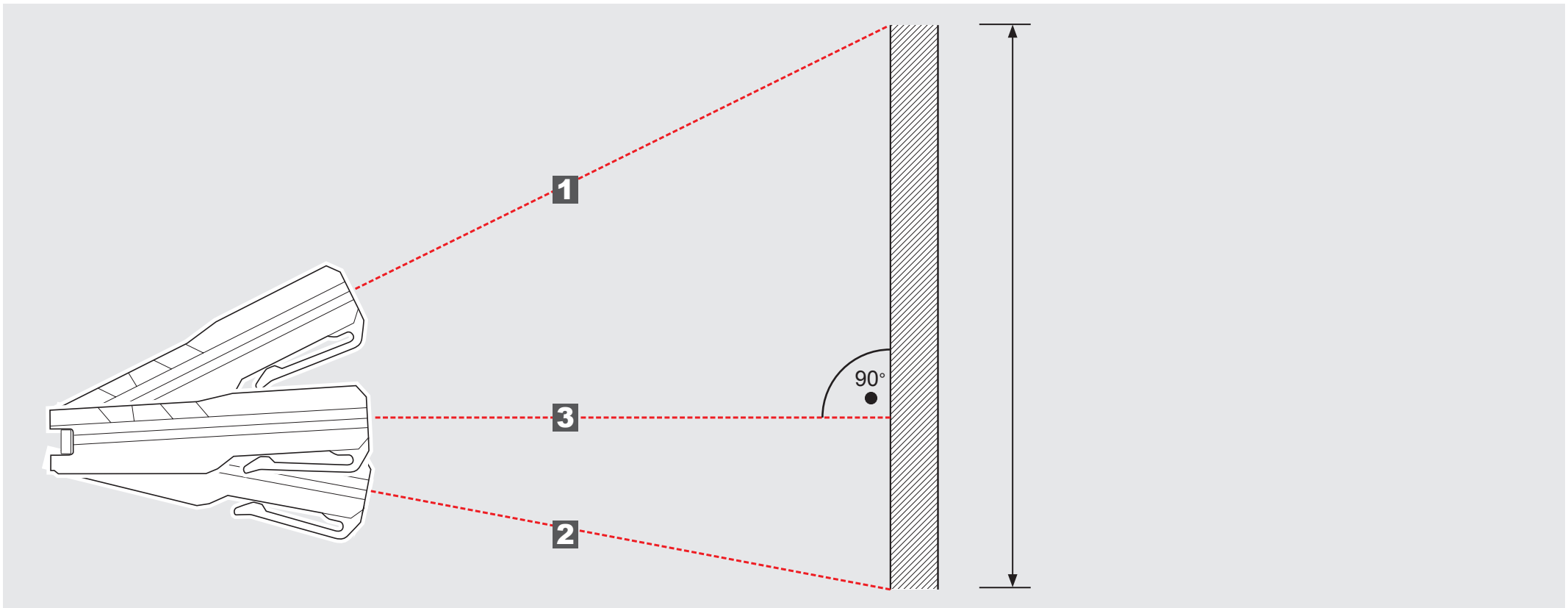

EPÄSUORA MITTAUS (PYTHAGORAS 3)

1



2

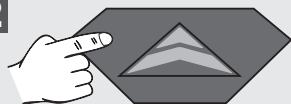



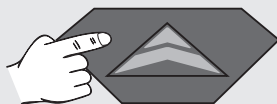



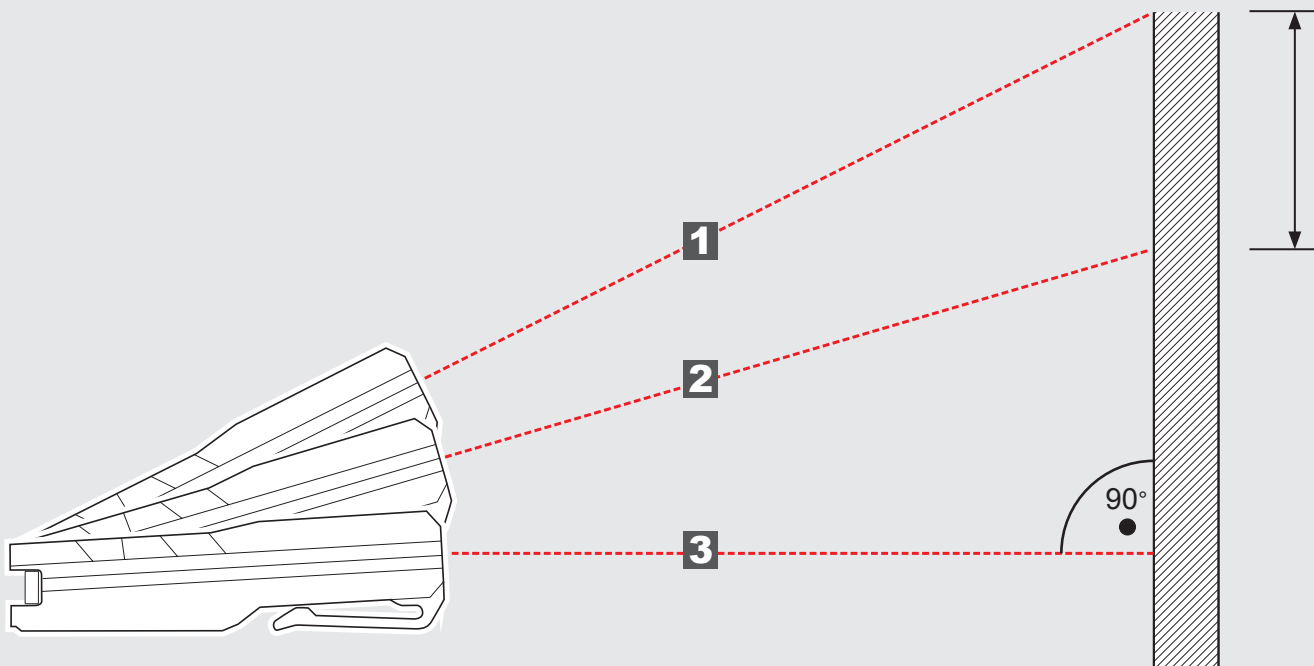
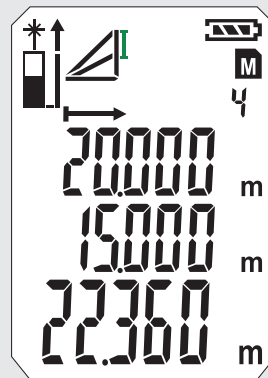
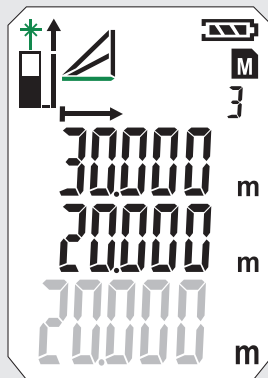
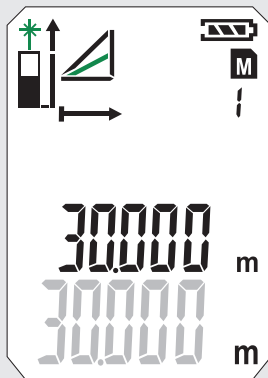
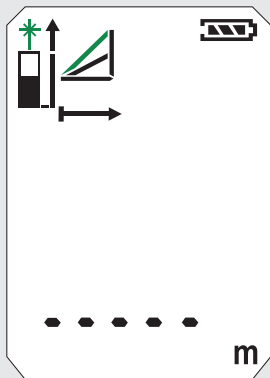

3





4

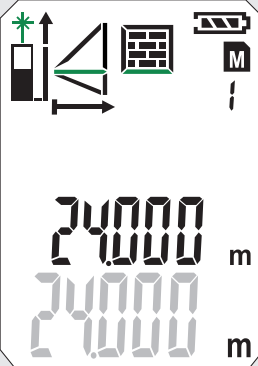

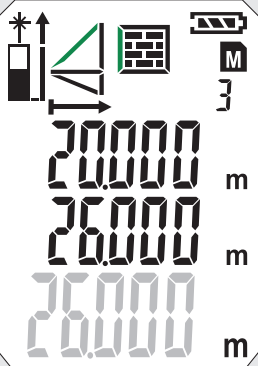
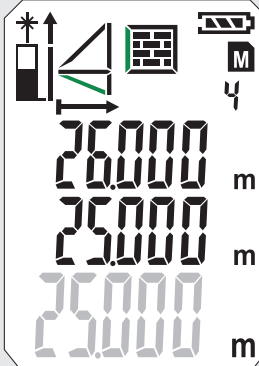
SEINÄN PINTA-ALAMITTAUS (MALLI 1)

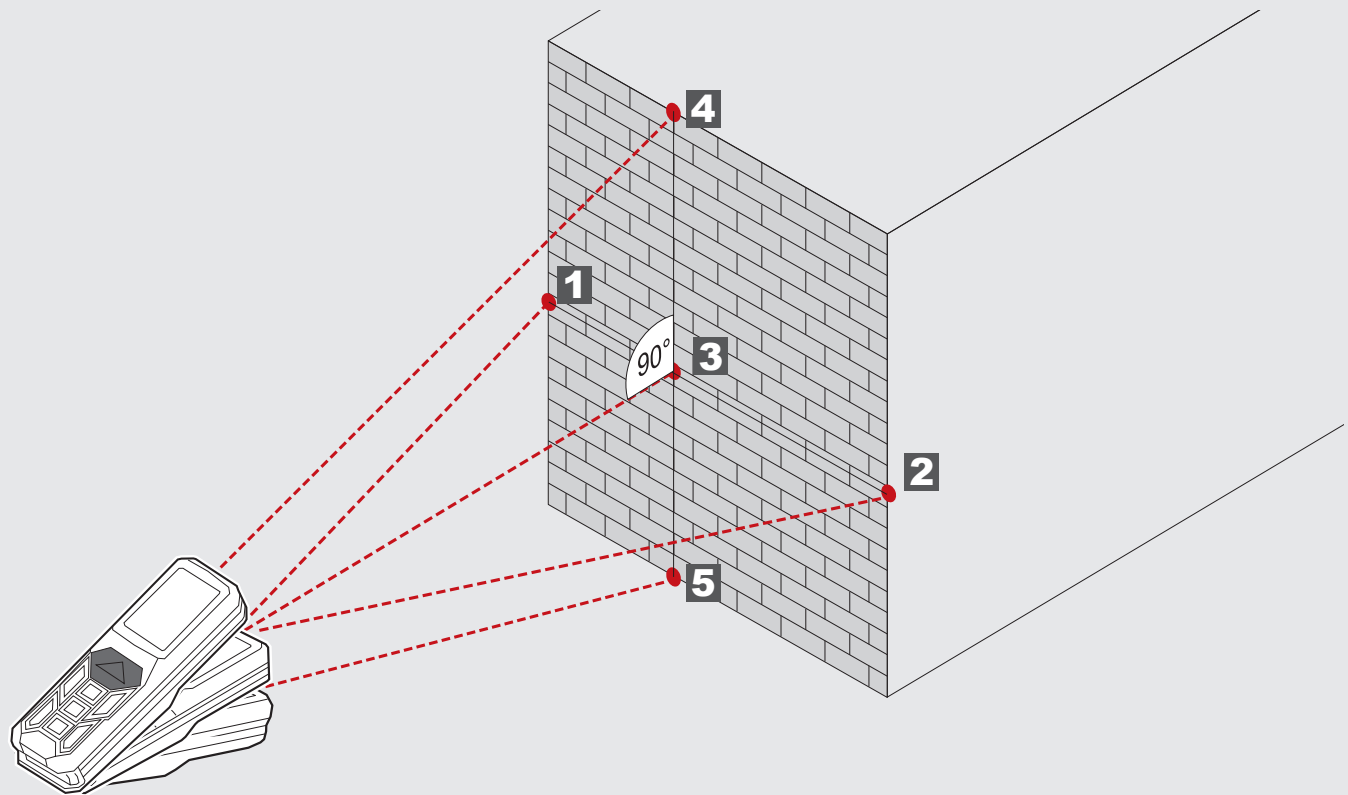
0 	1 	2 	3 	4 
				



5

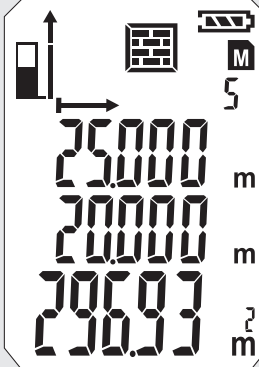

SEINÄN PINTA-ALAMITTAUS (MALLI 2)

0 	1 	2 	3 	4

5

AJASTIN

Ajastimen avulla mittaus voidaan suorittaa viiveellä, esim. rakenneosan sijoittamiseksi mittaussäteeseen.

Paina  -näppäintä

- Symboli tulee näyttöön
- Painamalla  -näppäintä voit säätää ajastimen keston 3 ja 15 sekunnin välille.

Paina  -näppäintä

- Sekunnit lasketaan alaspäin mittaukseen saakka.
- Arvossa 0 mittaus laukaistaan.

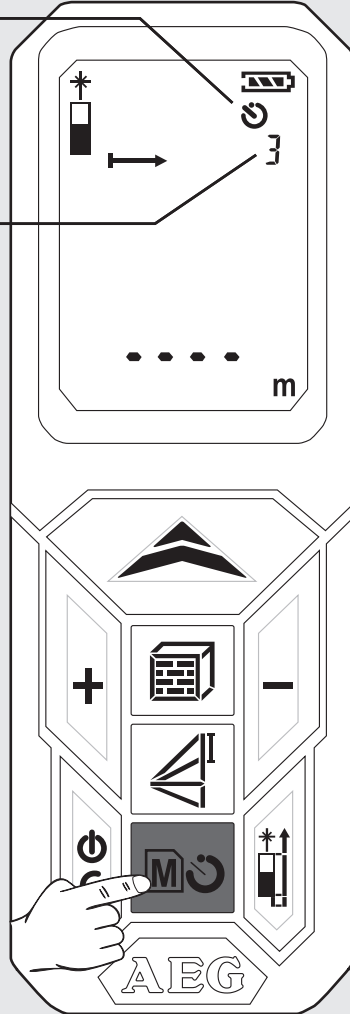

MUISTI

Mittausarvot tallennetaan automaattisesti jatkuvasti muistiin.

Tallennetut arvot saadaan näyttöön painamalla  -näppäintä.

Paina  -näppäintä 2 sek. ajan

- Näyttöön tulee symboli ja muistipaikka.
- Siihen kuuluva mittausarvo tulee näyttöön.
- Tallennettu arvo tulee näyttöön päiviville.
- Liiku +/- näppäimillä

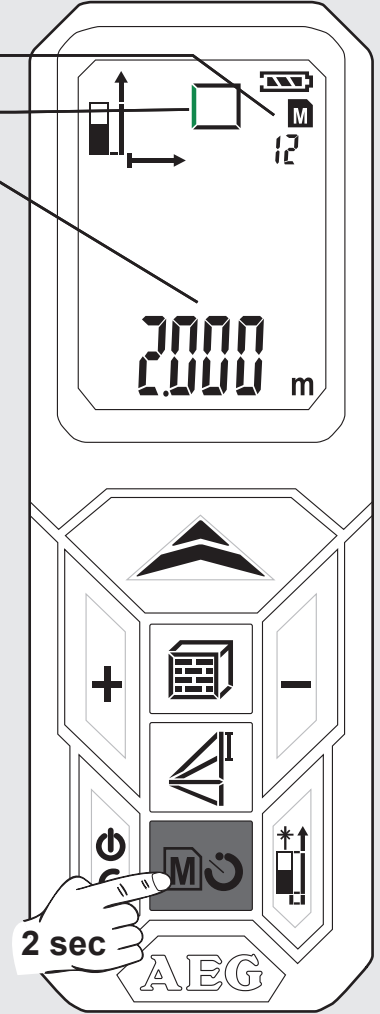

PERUSLUONTAINEN TOIMINTATAPA PINTA-ALAMITTAUKSEN (1) ESIMERKILLÄ NÄYTETTYNÄ



1 Päällekytkentä

Paina  -näppäintä.

 **Huomio!** Lasersäde on päällä!
Älä kohdista sitä ihmisiin!

2 Valitse mittaustaso

Vakioasetus päällekytkennän jälkeen: takana

Paina  1x -> nurkkaupikko
Paina  2x -> edessä
Paina  3x -> takana

3 Valitse toimento

Käynnistämisen jälkeen laite on aina asetettu pituusmittaukselle.
Paina  1x -> pinta-alamittaus

4 Mittaa pituus

Kohdista laite ja paina  -näppäintä

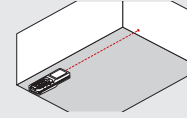

5 Mittaa leveys

Kohdista laite ja paina  -näppäintä

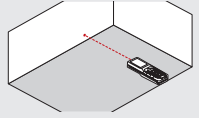

Lasersymboli vilkkuu (vilkkuminen esitetään vihreänä).

Näyttöön tulee symboli

- Näyttöön tulee symboli
- Mittausuure vilkkuu (vilkkuminen esitetään vihreänä).

- Mittausarvo tulee lyhyesti näkyviin päärivillä
- Mittausarvo siirtyy 1 sekunnin jälkeen sen yläpuolella olevalle riville
- Mittausarvo tallennetaan muistiin jatkuvalla numeroinnilla.
- Toinen mittausuure vilkkuu. Laite on valmis toisen arvon mittaamiseen.

- Mittausarvo tulee lyhyesti näkyviin päärivillä
- Mittausarvo siirtyy 1 sekunnin jälkeen sen yläpuolella olevalle riville
- Mittausarvo tallennetaan muistiin jatkuvalla numeroinnilla.
- Tulos näytetään päärivillä ja tallennetaan muistiin jatkuvalla numeroinnilla.

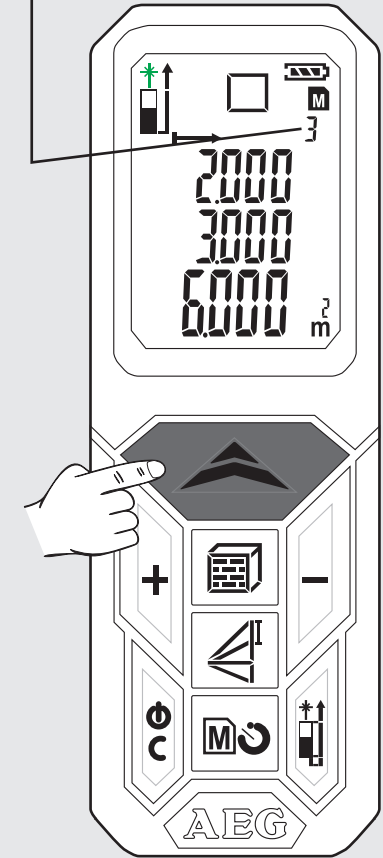
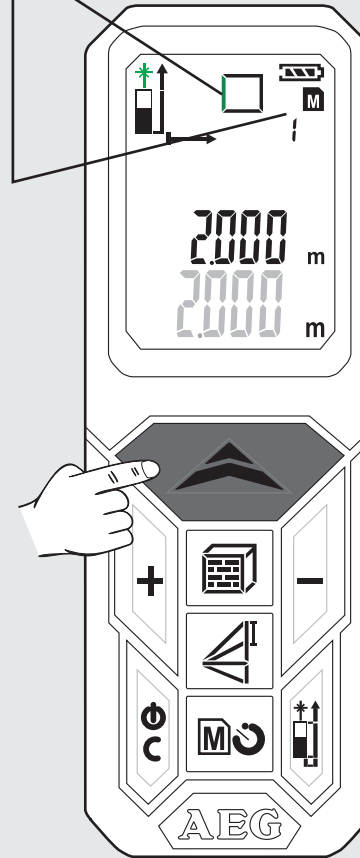
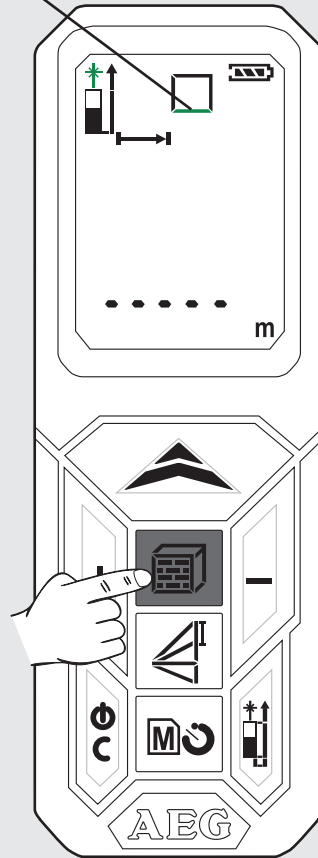
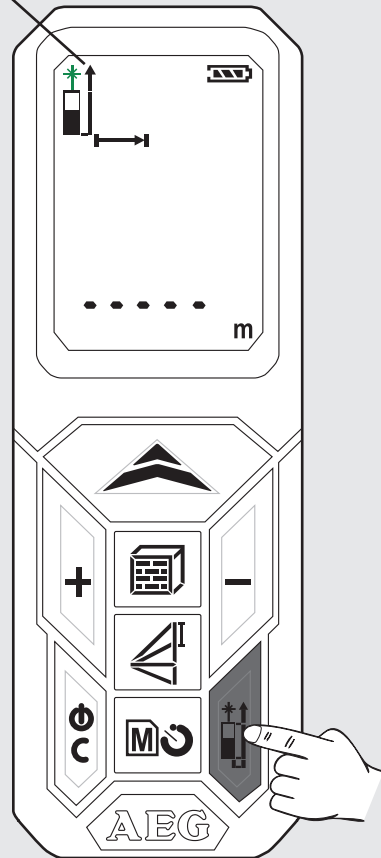
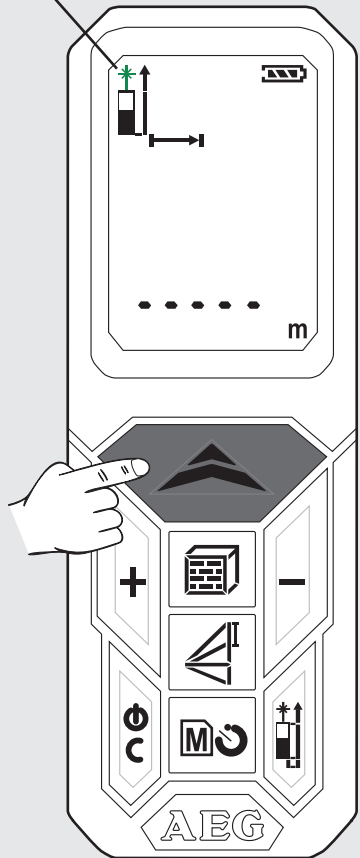

6 Hae tallennetut arvot näyttöön

Paina  -näppäintä 2 sek. ajan.

Paina + tai - näppäintä

7 Poistu muistista

Paina  -näppäintä

8 Sammuttaminen

Paina  -näppäintä 2 sek. ajan (sitä ennen täytyy poistua muistista).

- Tallennetut arvot tulevat näyttöön pääriville.

- Siihen kuuluva symboli tulee näyttöön ja mittaussuure vilkkuu (vilkuminen esitetään vihreänä).

- Laite sammuu.

- Jos 3 minuutin aikana ei paineta mitään näppäintä, niin laite sammuu automaattisesti.

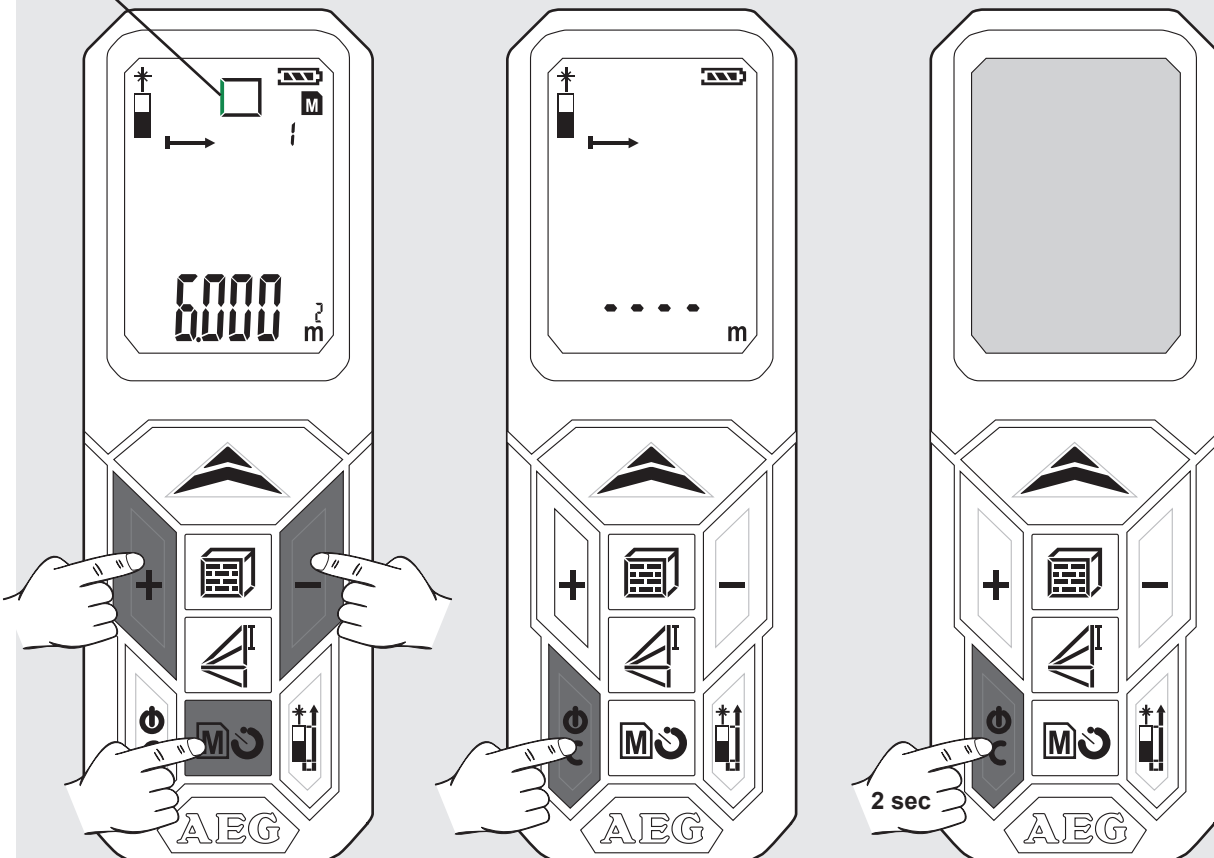

ΤΕΧΝΙΚΑ ΣΤΟΙΧΕΙΑ

Κατηγορία αντοχής για σκόνη και νερό	IP54
Φακός	14 mm
Εστιακό σημείο	35 mm
Μέγιστη απόσταση μέτρησης	50 μέτρα (ανοχή: 55 m)
Ελάχιστη απόσταση μέτρησης	0,05 μέτρα
Απόλυτη ακρίβεια @ < 10m	± 1,5 mm (Max)
Ακρίβεια επανάληψης @ < 10	± 1,5 mm (τιμή αναφοράς max. 2σ)
Ακρίβεια επανάληψης @ > 10	αύξηση κατά ± 0,25 mm / μέτρο (τιμή αναφοράς max. 2σ)
Χρόνος μέτρησης	0,5 s
Τύπος οθόνης	LCD (22,7mm x 31 mm)
Ηλεκτρική τροφοδοσία	AAA 2x (αλκαλική μπαταρία)
Χρόνος ζωής μπαταρίας	10000 (μεμονωμένες μετρήσεις)
Ισχύς εξόδου laser	0,6 mW ~ 0,95 mW (κλάση 2, 650nm)
Μέγεθος στίγματος laser	25 x 30 mm @ 16 m (Max)
Κατακόρυφη γωνία ακτίνας laser	+1 μοίρα
Οριζόντια γωνία ακτίνας laser	±1 μοίρα
Αυτόματη απενεργοποίηση συσκευής	180 δευτερόλεπτα
Αυτόματη απενεργοποίηση laser	30 δευτερόλεπτα
Περιοχή θερμοκρασίας λειτουργίας	-10°C μέχρι +50°C
Περιοχή θερμοκρασίας αποθήκευσης	-25°C μέχρι +70°C
Βάρος χωρίς μπαταρία	80 g

ΧΡΗΣΗ ΣΥΜΦΩΝΑ ΜΕ ΤΟ ΣΚΟΠΟ ΠΡΟΟΡΙΣΜΟΥ

Η συσκευή μέτρησης απόστασης με ακτίνα laser είναι κατάλληλη για μετρήσεις απόστασης και κλίσης.

Αυτή η συσκευή επιτρέπεται να χρησιμοποιηθεί μόνο σύμφωνα με τον αναφερόμενο σκοπό προορισμού.

ΠΙΝΑΚΑΣ ΚΩΔΙΚΩΝ ΣΦΑΛΜΑΤΩΝ

Κωδικός	Περιγραφή	Λύση
Err01	Εκτός περιοχής μέτρησης	Διεξάγετε την μέτρηση μέσα στην προβλεπόμενη περιοχή μέτρησης.
Err02	Το ανακλώμενο σήμα είναι πολύ αδύναμο	Διαλέξτε μια καλύτερη επιφάνεια.
Err03	Εκτός περιοχής ένδειξης (μεγ. τιμή: 99.999) π.χ. το αποτέλεσμα της επιφάνειας ή του όγκου ξεπερνά τη μέγιστη τιμή ένδειξης	Ελέγξτε αν οι τιμές και τα βήματα της διαδικασίας είναι σωστά.
Err04	Σφάλμα στον πυθαγόρειο υπολογισμό	Ελέγξτε αν οι τιμές και τα βήματα της διαδικασίας είναι σωστά.
Err05	Αδύναμη μπαταρία	Βάλτε καινούριες μπαταρίες
Err06	Εκτός περιοχής θερμοκρασίας λειτουργίας	Διεξάγετε την μέτρηση μέσα στην προβλεπόμενη περιοχή θερμοκρασίας.
Err07	Περιβάλλον πολύ φωτεινό	Φροντίστε ώστε η περιοχή μέτρησης να μην είναι πολύ φωτεινή.

Πυθαγόρας
Διαφορά ύψους

Επίπεδο μέτρησης

Μέτρηση μήκους

Ελάχιστο / μέγιστο για συνεχή μέτρηση

Πρόσθεση / αφαίρεση

ON / ΜΕΤΡΗΣΗ

- ▶ On
- ▶ Μέτρηση
- ▶ Συνεχής μέτρηση (πιέστε για 2 δευτερόλεπτα)
Μέγιστο / ελάχιστο Λειτουργία

ΠΡΟΣΘΕΣΗ

- ▶ Πρόσθεση τιμής
- ▶ Πλοήγηση στη μνήμη

ΕΠΙΦΑΝΕΙΑ / ΟΓΚΟΣ

- ▶ Επιφάνεια (πιέστε 1x)
- ▶ Όγκος (πιέστε 2x)
- ▶ Έμμεση μέτρηση επιφάνειας (πιέστε 3x / 4x)

ΕΝΕΡΓΟΠΟΙΗΣΗ

- ▶ On
- ▶ Off (πιέστε για 2 δευτερόλεπτα)
- ▶ Διαγραφή

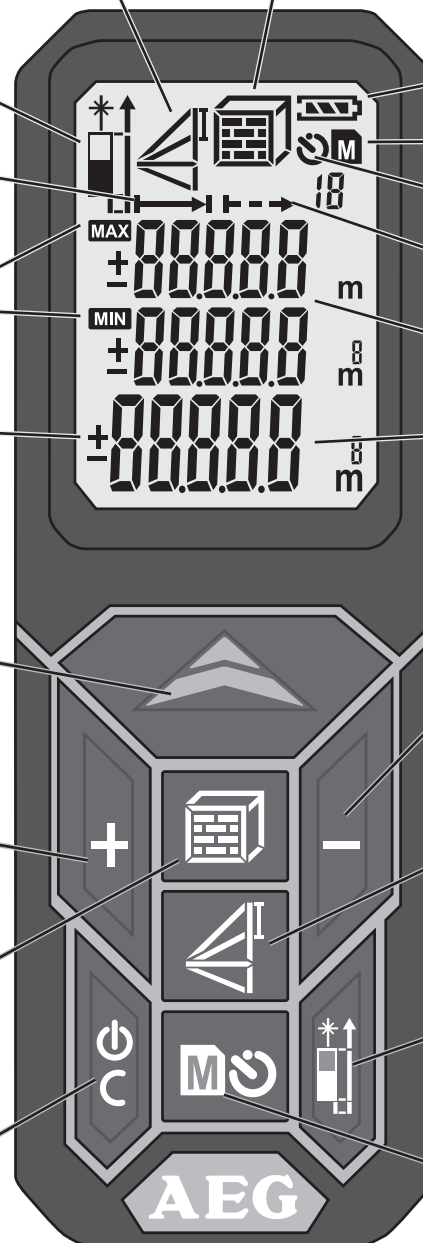

Επιφάνεια / όγκος
Έμμεση μέτρηση επιφάνειας

Κατάσταση μπαταρίας

Μνήμη

Χρονοδιακόπτης

Συνεχής μέτρηση

Ενδιάμεσες τιμές

Συνολική τιμή

ΑΦΑΙΡΕΣΗ

- ▶ Αφαίρεση τιμής
- ▶ Πλοήγηση στη μνήμη

ΠΥΘΑΓΟΡΑΣ

- ▶ Πυθαγόρας 1 (πιέστε 1x)
- ▶ Πυθαγόρας 2 (πιέστε 2x)
- ▶ Πυθαγόρας 3 (πιέστε 3x)

ΑΛΛΑΓΗ ΕΠΙΠΕΔΟΥ ΜΕΤΡΗΣΗΣ

- ▶ Μπροστά
- ▶ Πίσω
- ▶ Ακίδα γωνίας

ΜΝΗΜΗ

- ▶ Χρονοδιακόπτης 3-15 δευτερόλεπτα (πιέστε 1x)
- ▶ Μνήμη 1-20 (πιέστε 1x για 2 δευτερόλεπτα)
- ▶ Πλοήγηση στη μνήμη πιέζοντας τα πλήκτρα +/-

ΑΛΛΑΓΗ ΜΠΑΤΑΡΙΑΣ

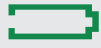
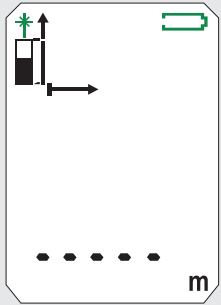

Αλλάξτε την μπαταρία, αν αναβοσβήνει το σύμβολο.

1

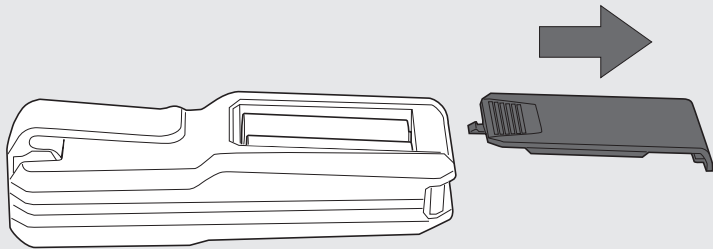

2

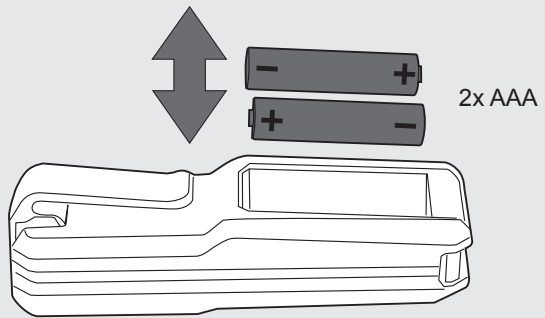

3

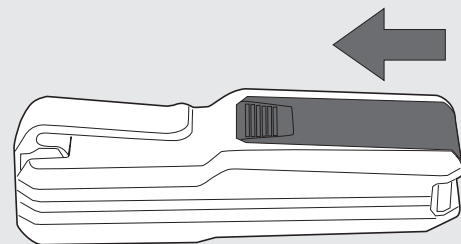

ΑΚΙΔΑ ΓΩΝΙΑΣ

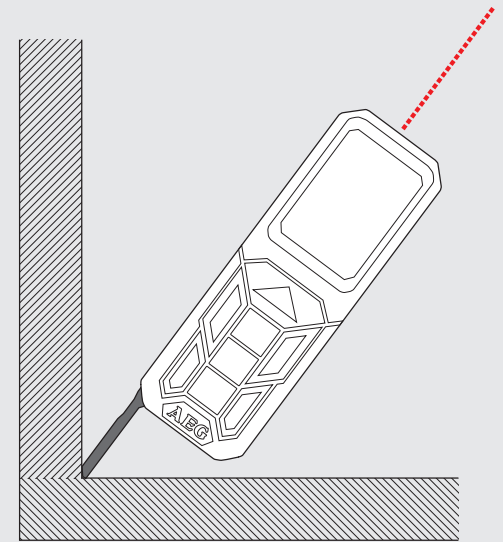
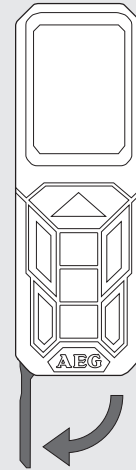

ΚΛΙΠ ΖΩΝΗΣ

1

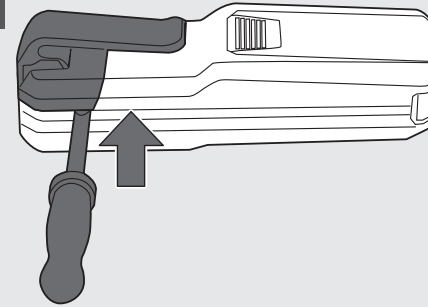

2

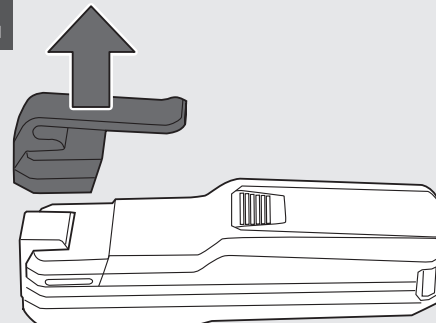

3

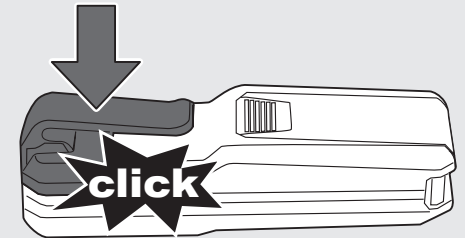

ΑΠΛΗ ΜΕΤΡΗΣΗ ΑΠΟΣΤΑΣΗΣ

0

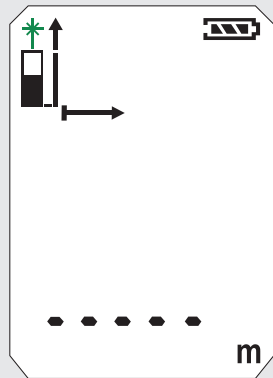

1

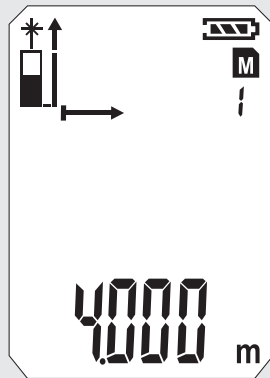
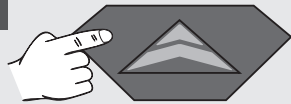

2

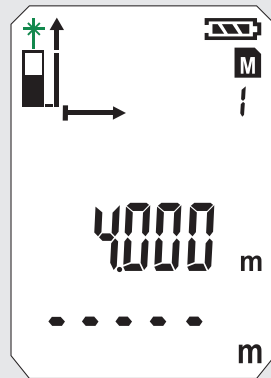
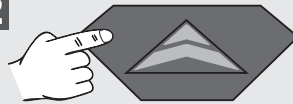

3

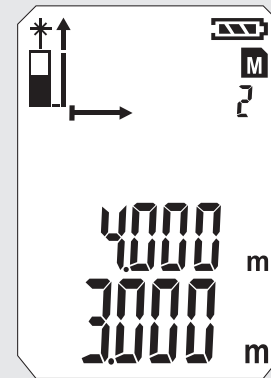
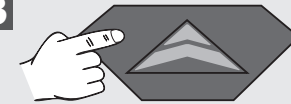

4

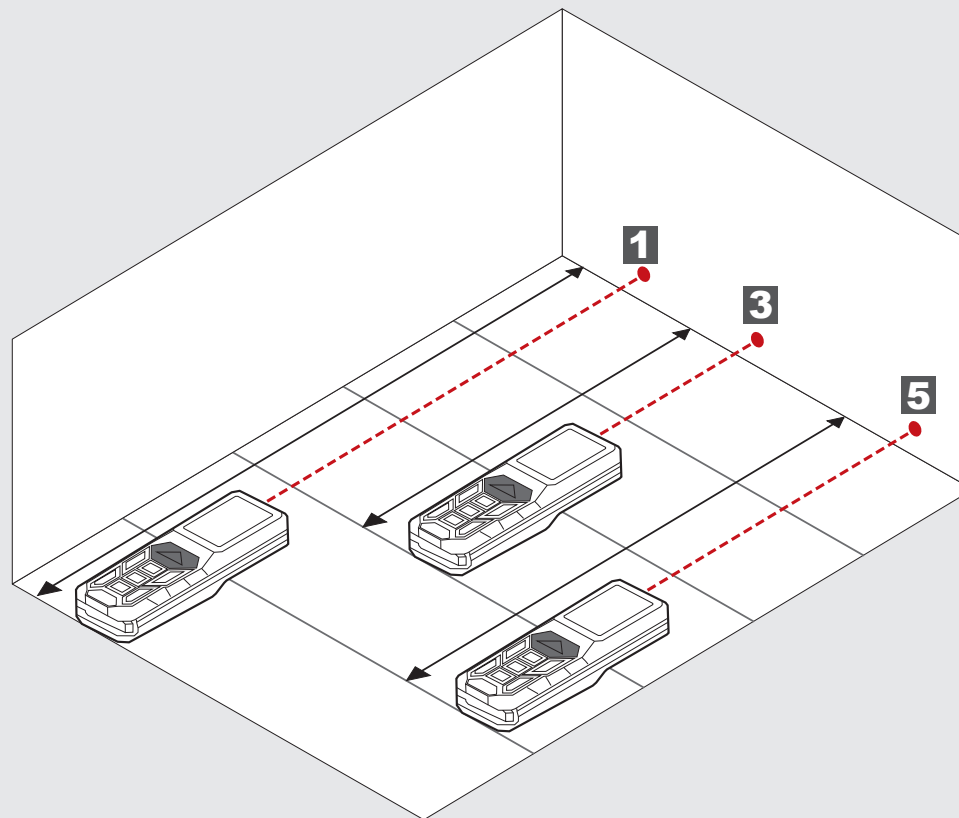
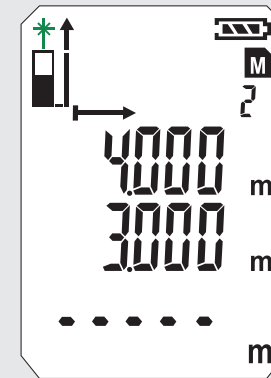
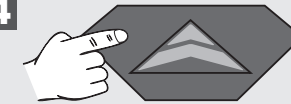

5

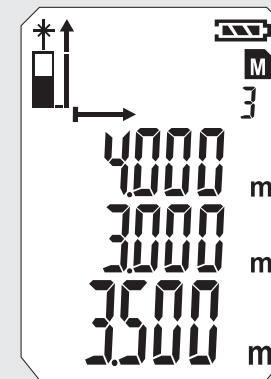
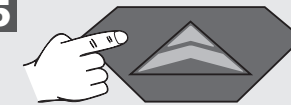

ΣΥΝΕΧΗΣ ΜΕΤΡΗΣΗ / ΜΕΤΡΗΣΗ ΜΕΓΙΣΤΟΥ-ΕΛΑΧΙΣΤΟΥ

0

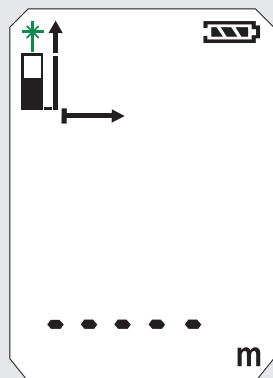

1

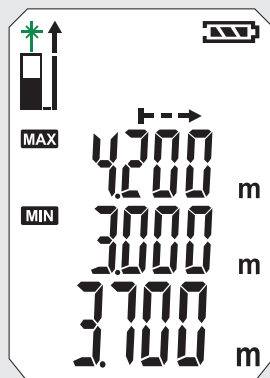
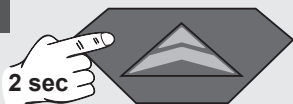

2

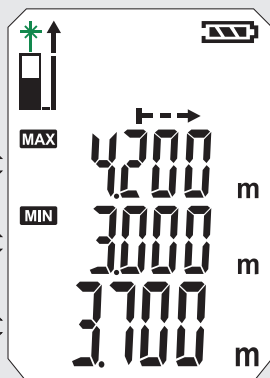

3

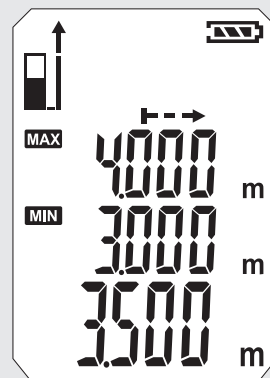
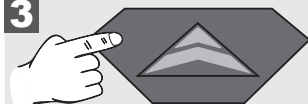

4

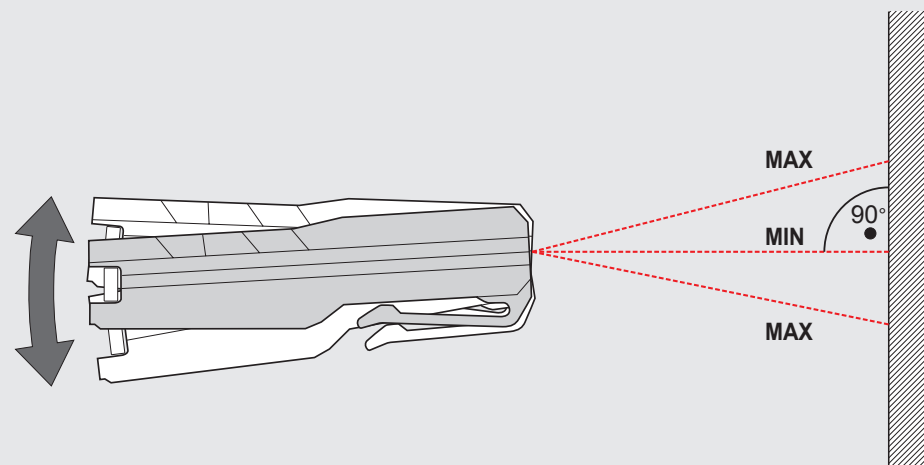
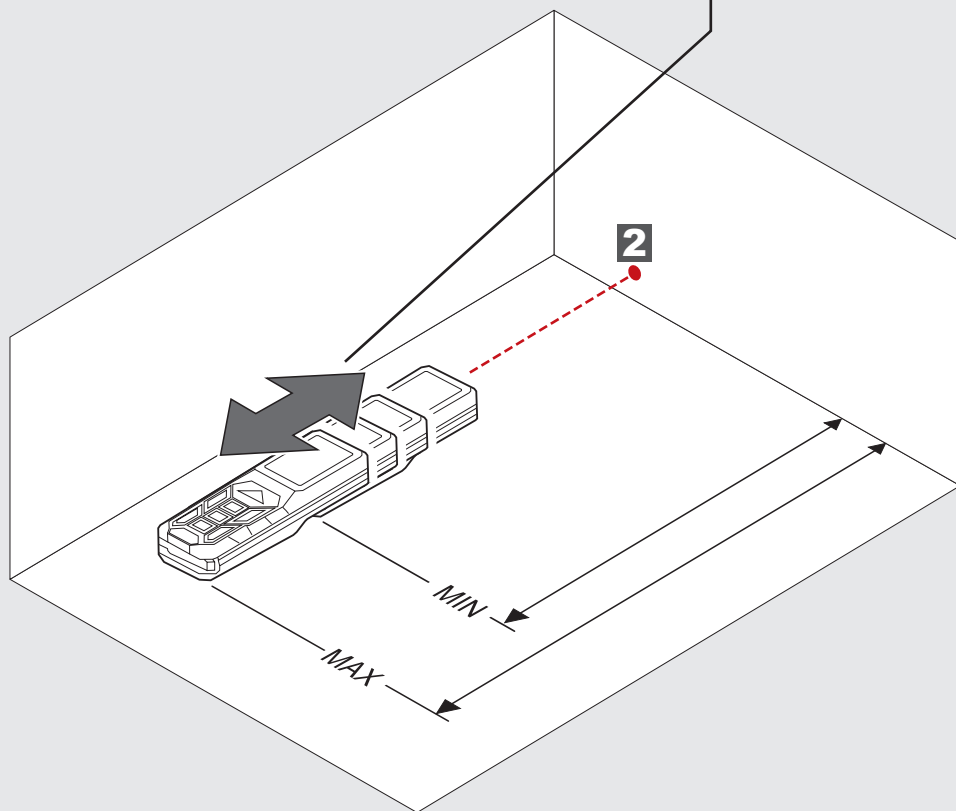
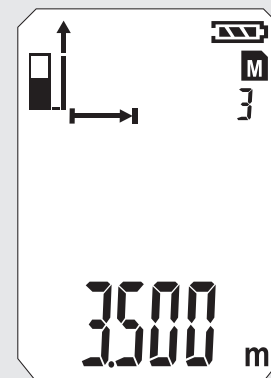

0

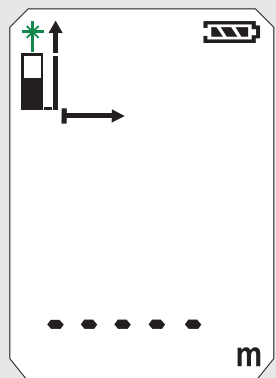

1

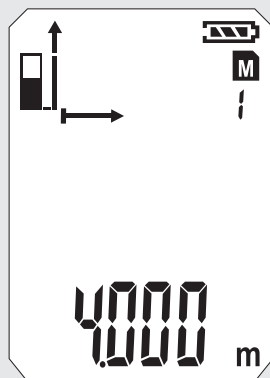
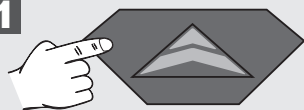

2

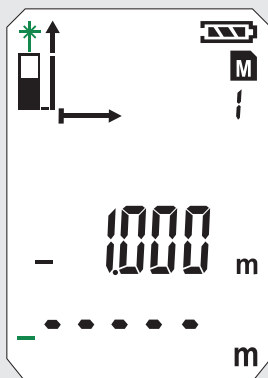
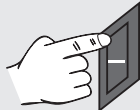

3

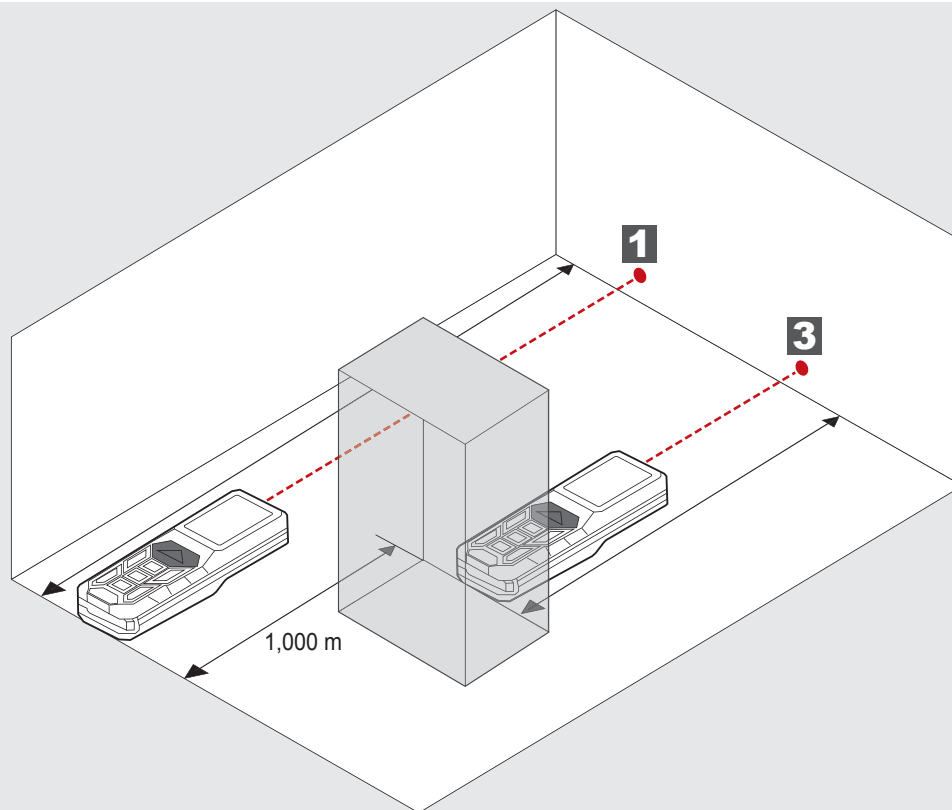
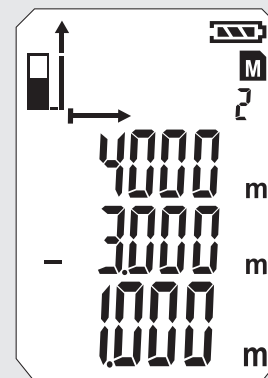
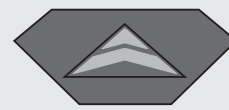

0



1

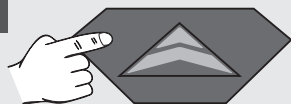

2

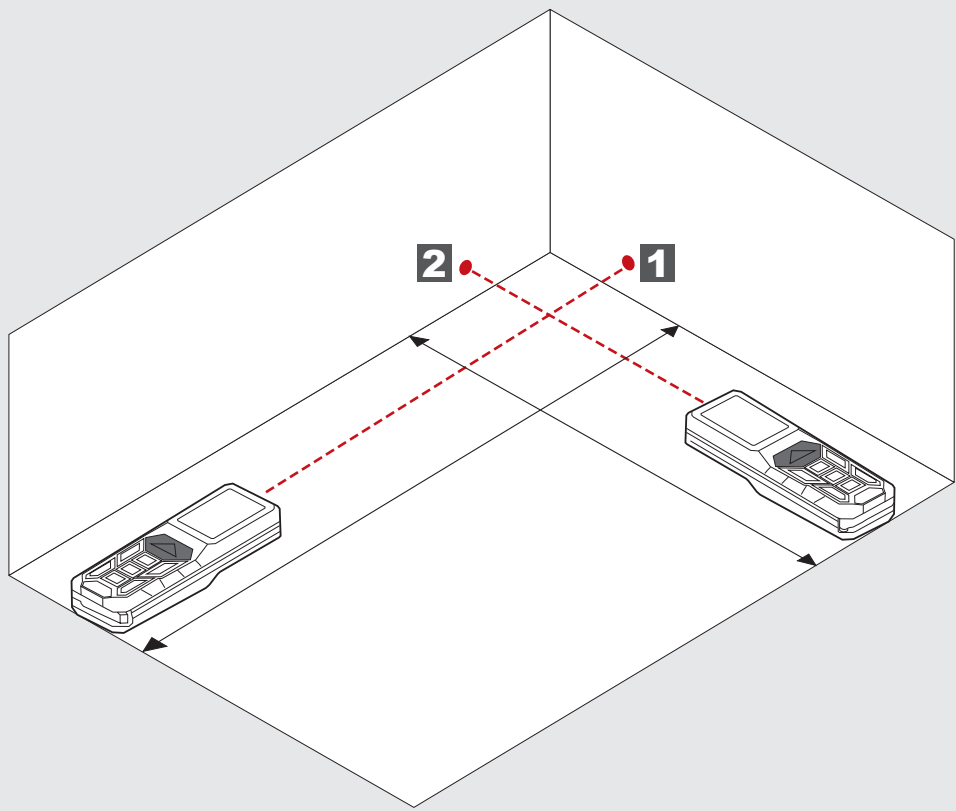
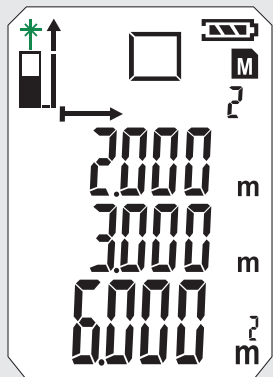
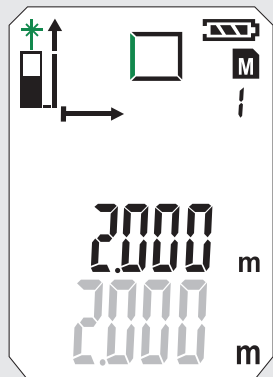
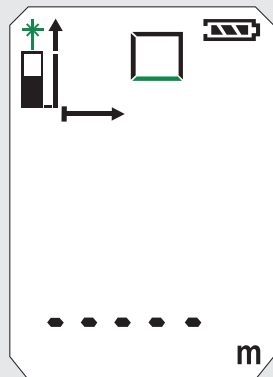
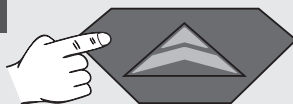

0



1

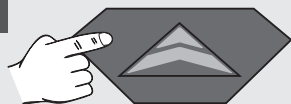

2

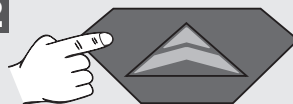

3

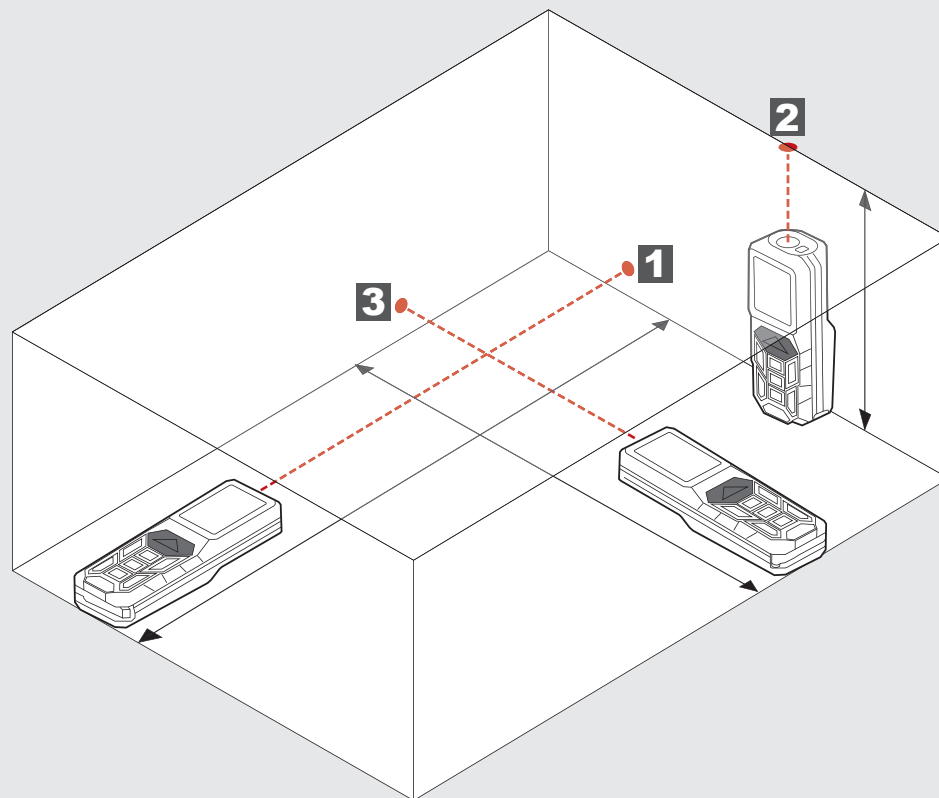
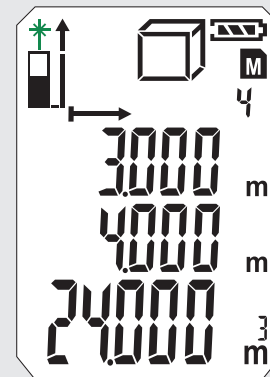
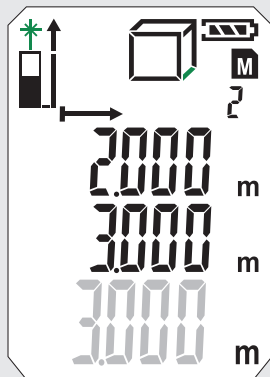
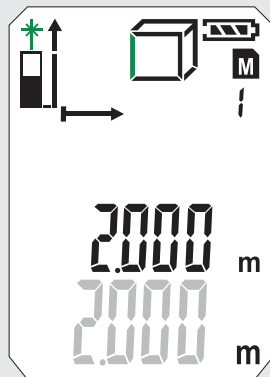
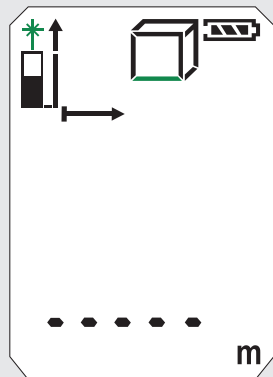
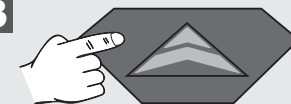

ΕΜΜΕΣΗ ΜΕΤΡΗΣΗ (ΠΥΘΑΓΟΡΑΣ 1)

0



1

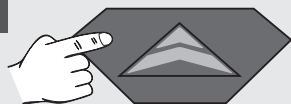

2

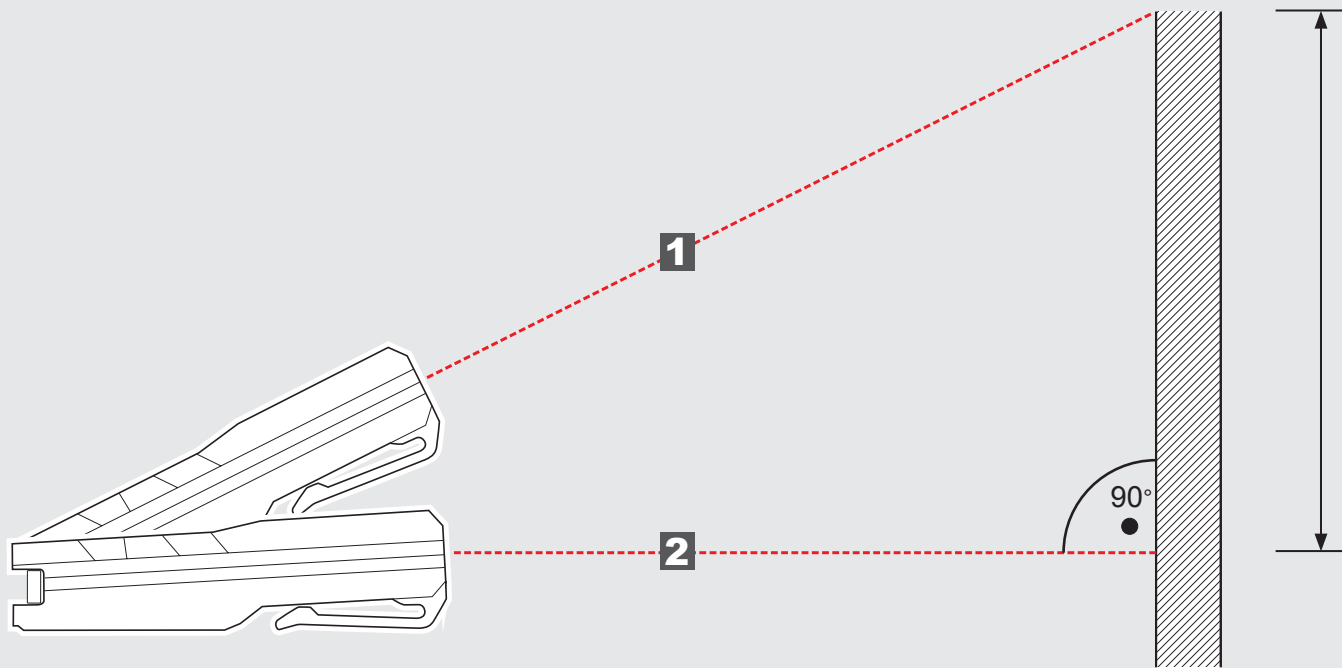
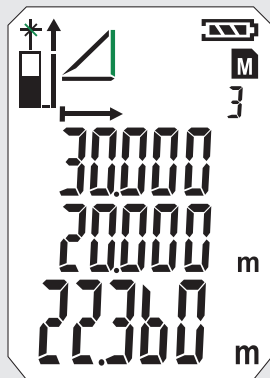
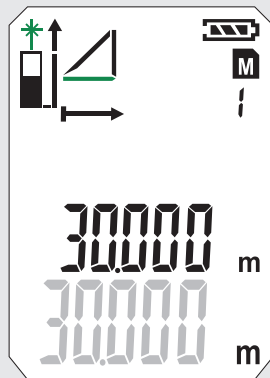
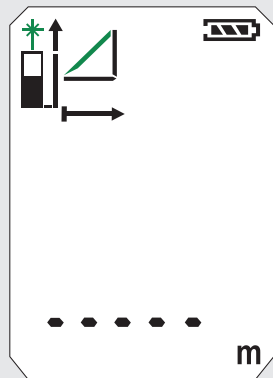
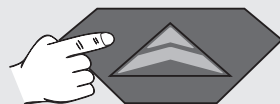

ΕΜΜΕΣΗ ΜΕΤΡΗΣΗ (ΠΥΘΑΓΟΡΑΣ 2)

0



1

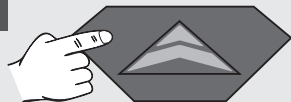

2

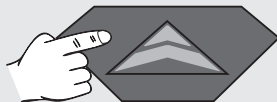

3

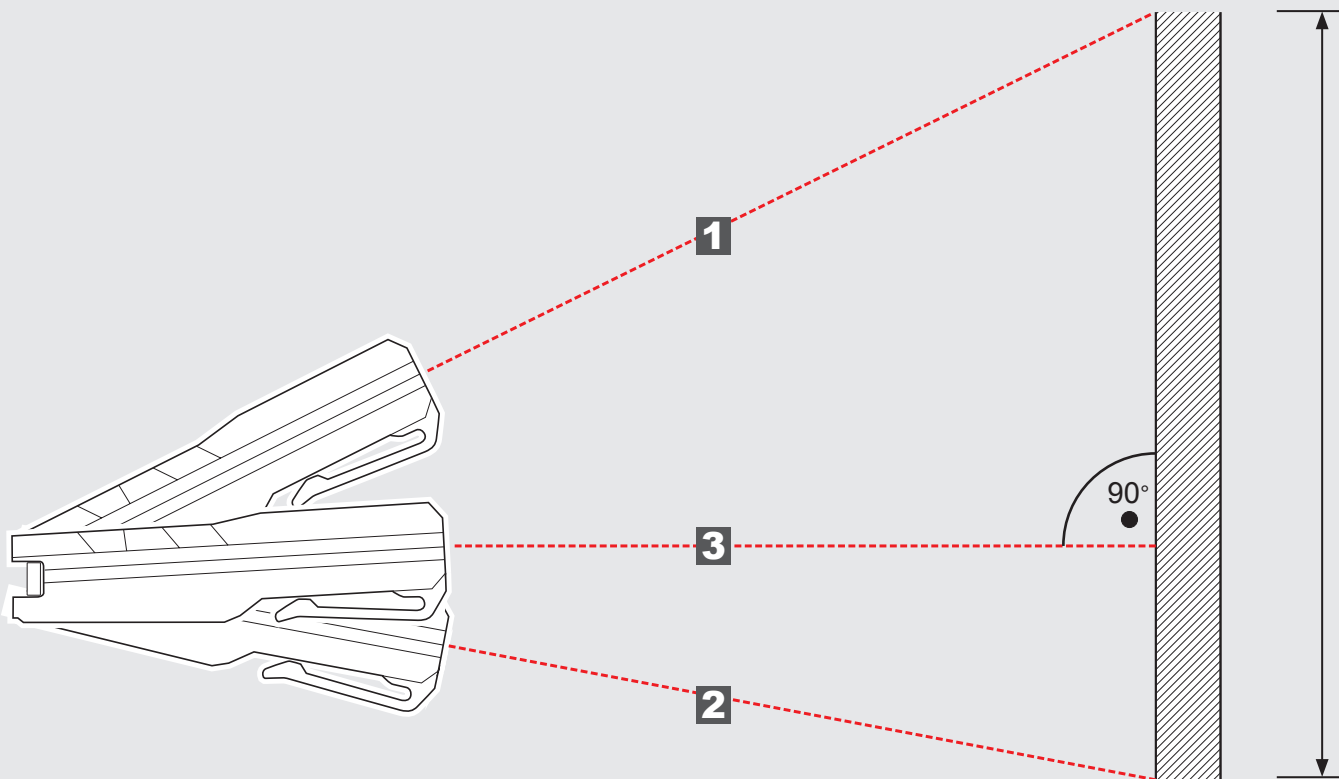
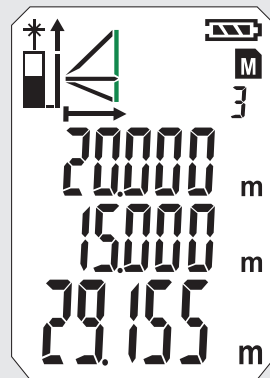
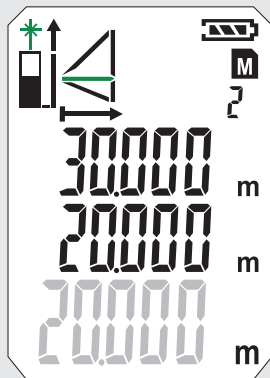
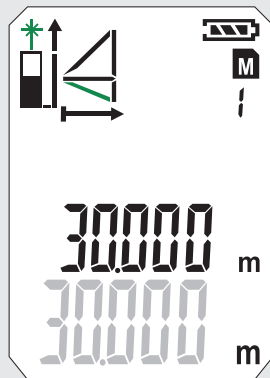
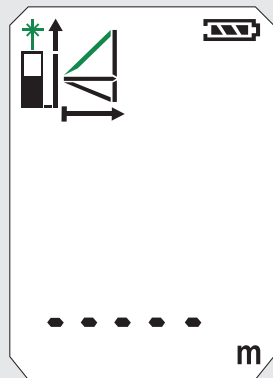

ΕΜΜΕΣΗ ΜΕΤΡΗΣΗ (ΠΥΘΑΓΟΡΑΣ 3)

1



2

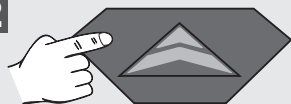





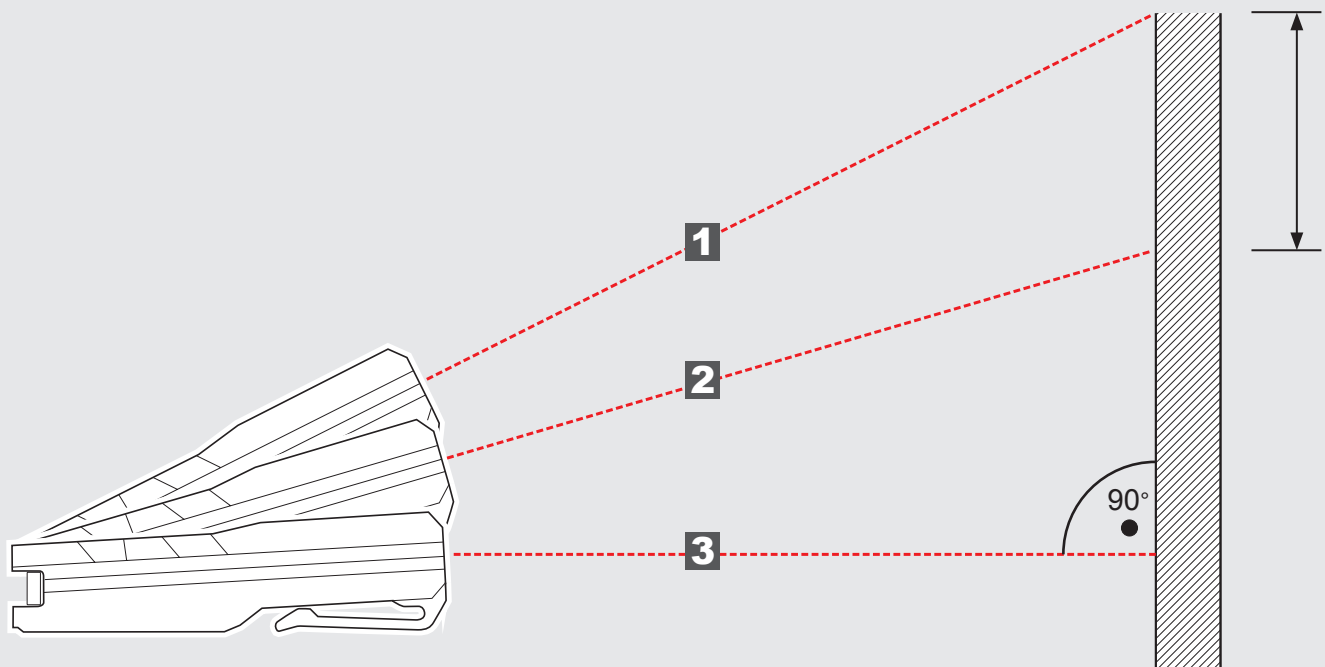
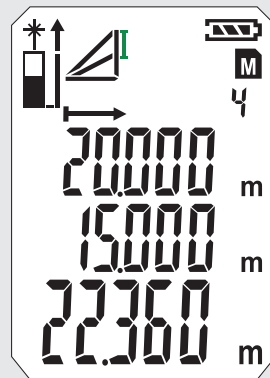
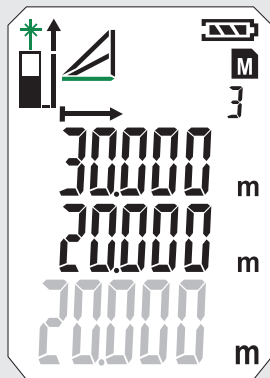
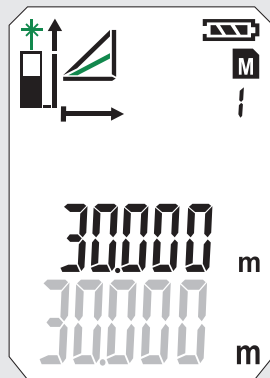
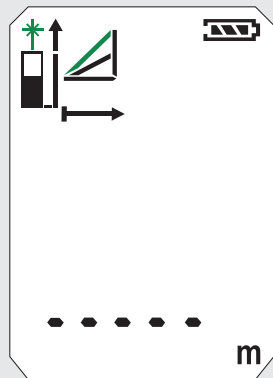

3





4

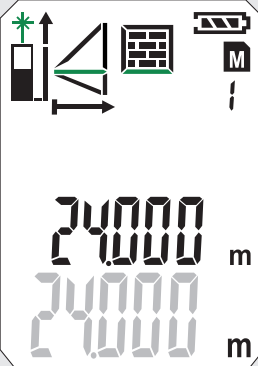
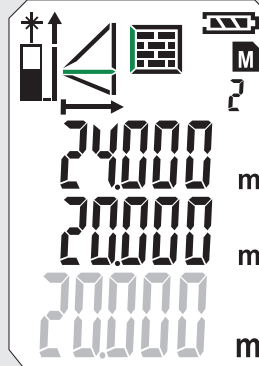
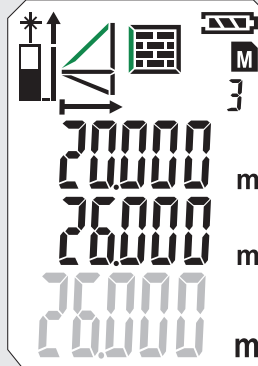
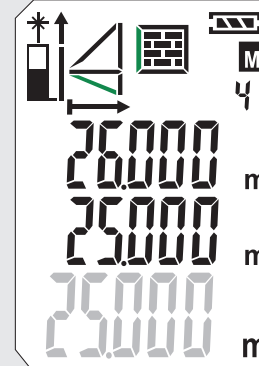

ΜΕΤΡΗΣΗ ΕΠΙΦΑΝΕΙΑΣ ΤΟΙΧΟΥ (ΔΙΑΔΙΚΑΣΙΑ 1)

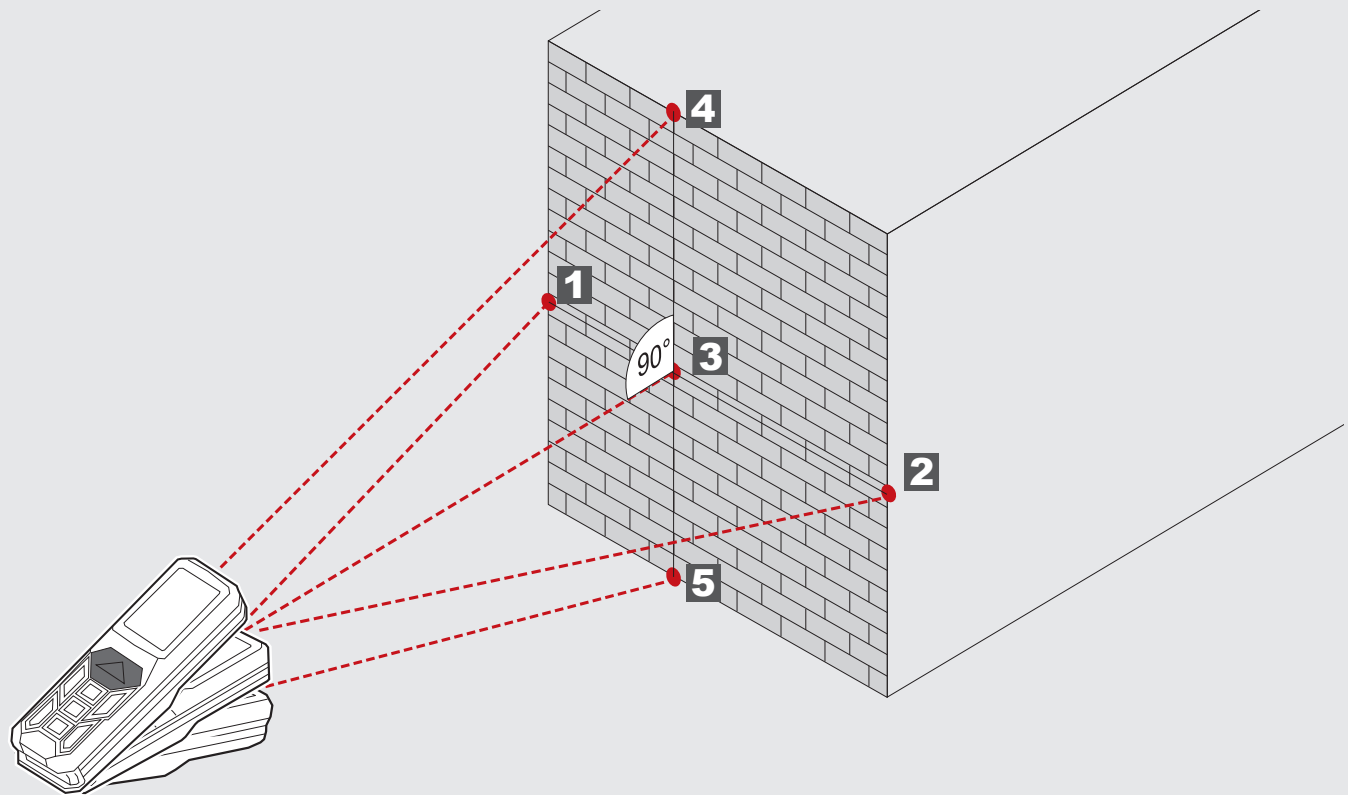



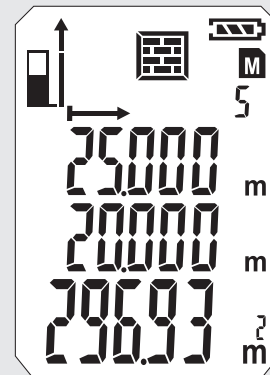

0 	1 	2 	3 	4 
				



5

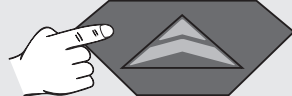
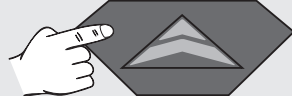

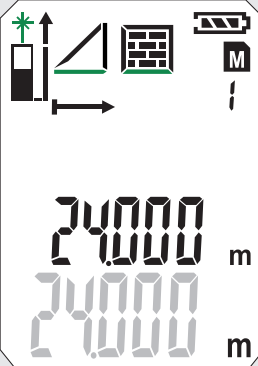
ΜΕΤΡΗΣΗ ΕΠΙΦΑΝΕΙΑΣ ΤΟΙΧΟΥ (ΔΙΑΔΙΚΑΣΙΑ 2)

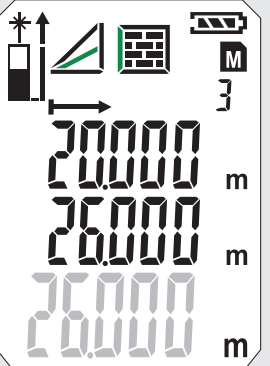
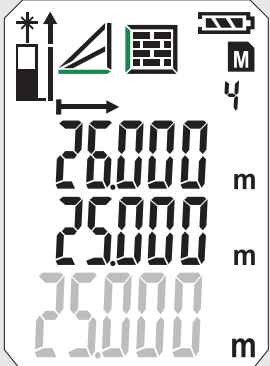
0 	1 	2 	3 	4 
				

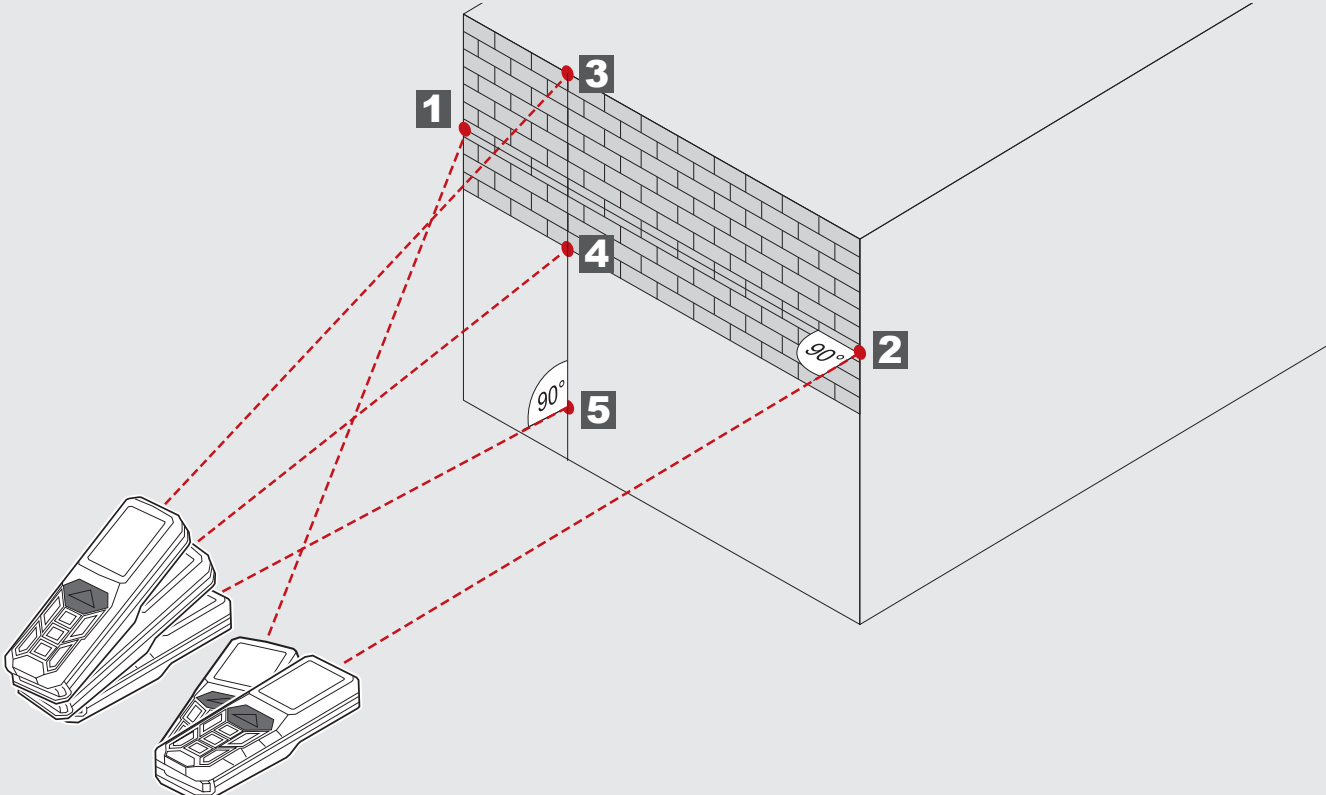

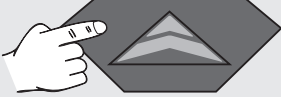

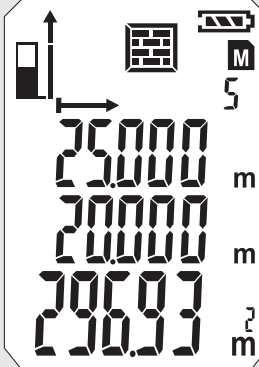
5





ΧΡΟΝΟΔΙΑΚΟΠΤΗΣ

Χρησιμοποιώντας τον χρονοδιακόπτη μπορείτε να διενεργήσετε την μέτρηση με καθυστέρηση, ούτως ώστε να τοποθετήσετε π.χ. ένα εξάρτημα στην ακτίνα μέτρησης

Πιέστε το πλήκτρο 

- Το σύμβολο εμφανίζεται
Πιέζοντας το πλήκτρο  μπορείτε να ρυθμίσετε τον χρονοδιακόπτη ανάμεσα σε 3 και 15 δευτερόλεπτα.

Πιέστε το πλήκτρο 

- Αντίστροφη μέτρηση των δευτερολέπτων μέχρι την μέτρηση.

- Στο 0 λαμβάνει χώρα η μέτρηση.

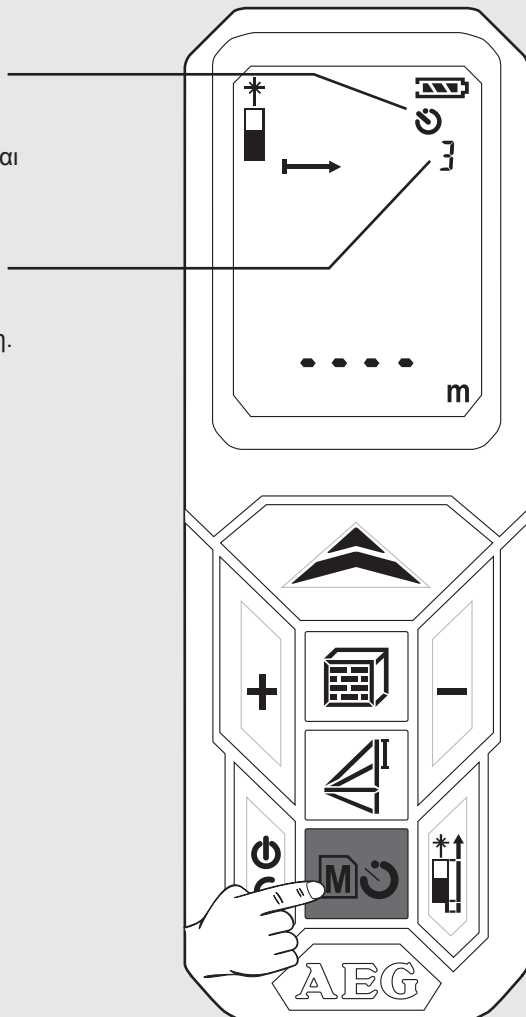

ΜΝΗΜΗ

Οι τιμές μέτρησης αποθηκεύονται διαδοχικά και αυτόματα στην μνήμη.

Οι αποθηκευμένες τιμές μπορούν να ανακληθούν πιέζοντας το πλήκτρο .

Πιέστε το πλήκτρο  για 2 δευτερόλεπτα.

- Εμφανίζεται το σύμβολο και ο αριθμός θέσης μνήμης.

- Εμφανίζεται το αντίστοιχο μέγεθος μέτρησης.

- Εμφανίζεται η αποθηκευμένη τιμή στην κύρια γραμμή.

- Πλοήγηση με τα πλήκτρα +/-

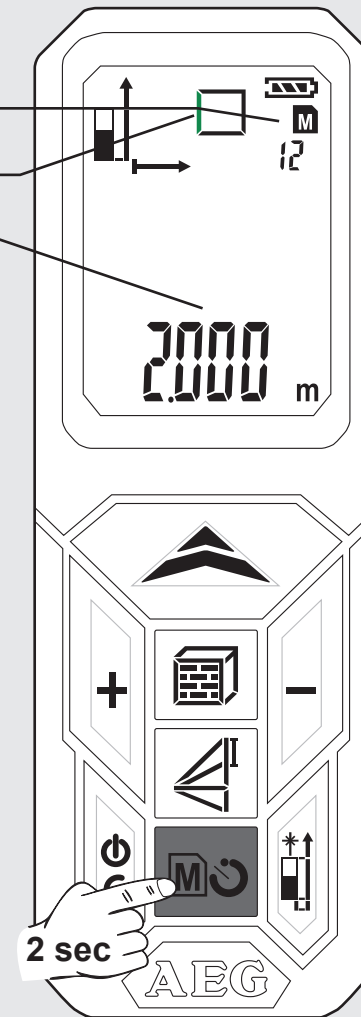



ΠΕΡΙΓΡΑΦΗ ΤΗΣ ΒΑΣΙΚΗΣ ΔΙΑΔΙΚΑΣΙΑΣ ΜΕΤΡΗΣΗΣ ΧΡΗΣΙΜΟΠΟΙΩΝΤΑΣ ΤΟ ΠΑΡΑΔΕΙΓΜΑ ΜΙΑΣ ΜΕΤΡΗΣΗΣ ΕΠΙΦΑΝΕΙΑΣ (1)

1 Ενεργοποιήστε

Πιέστε το πλήκτρο .
⚠ Προσοχή! Το laser είναι ενεργό!
 Μην το στρέψετε πάνω σε ανθρώπους!

Το σύμβολο laser αναβοσβήνει (Στην εικόνα το πράσινο σύμβολο)

2 Επιλογή επιπέδου μέτρησης

Στάνταρντ ρύθμιση μετά την ενεργοποίηση: Πίσω
 Πιέστε 1x -> Ακίδα γωνίας
 Πιέστε 2x -> Μπροστά
 Πιέστε 3x -> Πίσω

Εμφανίζεται το σύμβολο

3 Επιλογή λειτουργίας

Μετά την ενεργοποίηση η συσκευή είναι ρυθμισμένη σε μέτρηση απόστασης.
 Πιέστε  1x - Μέτρηση επιφάνειας.

- Εμφανίζεται το σύμβολο
 - Το μέγεθος της μέτρησης αναβοσβήνει (Στην εικόνα το πράσινο σύμβολο)

4 Μέτρηση μήκους

Ευθυγραμμίστε την συσκευή και πιέστε .

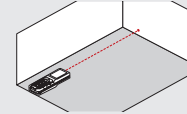

- Η τιμή μέτρησης εμφανίζεται για λίγο στην κύρια γραμμή.
 - Μετά από 1 δευτερόλεπτο η τιμή μέτρησης αλλάζει θέση στην γραμμή από πάνω.
 - Η τιμή μέτρησης αποθηκεύεται στην μνήμη με αύξοντα αριθμό.
 - Αναβοσβήνει το δεύτερο μέγεθος μέτρησης. Η συσκευή είναι έτοιμη για τη μέτρηση της δεύτερης τιμής.

5 Μέτρηση πλάτους

Ευθυγραμμίστε την συσκευή και πιέστε .

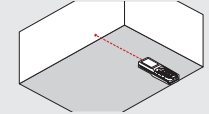

- Η τιμή μέτρησης εμφανίζεται για λίγο στην κύρια γραμμή.
 - Μετά από 1 δευτερόλεπτο η τιμή μέτρησης αλλάζει θέση στην γραμμή από πάνω.
 - Η τιμή μέτρησης αποθηκεύεται στην μνήμη με αύξοντα αριθμό.
 - Το αποτέλεσμα εμφανίζεται στην κύρια γραμμή και αποθηκεύεται στην μνήμη με αύξοντα αριθμό.

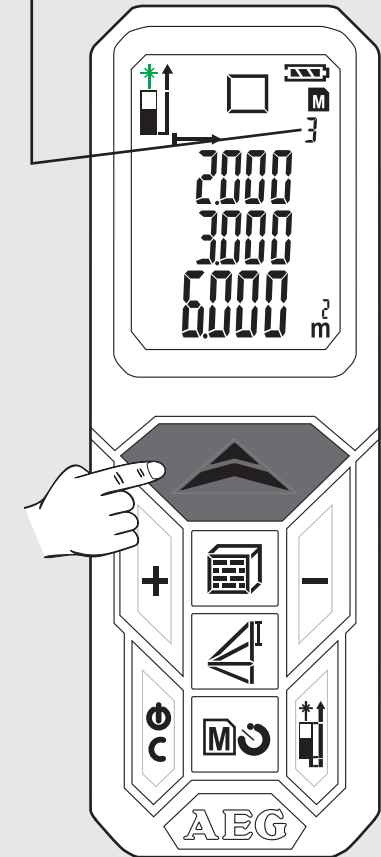
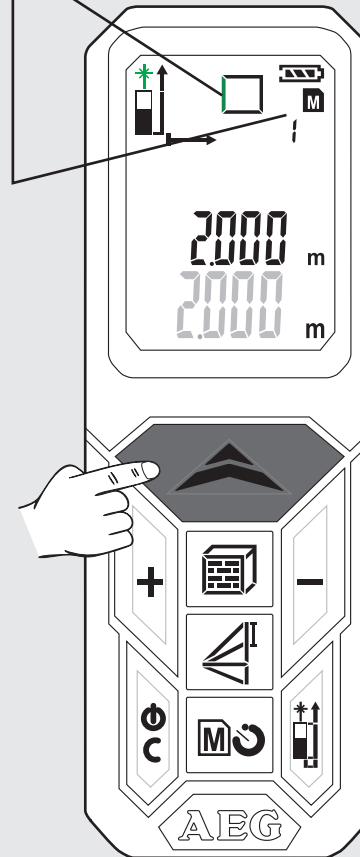
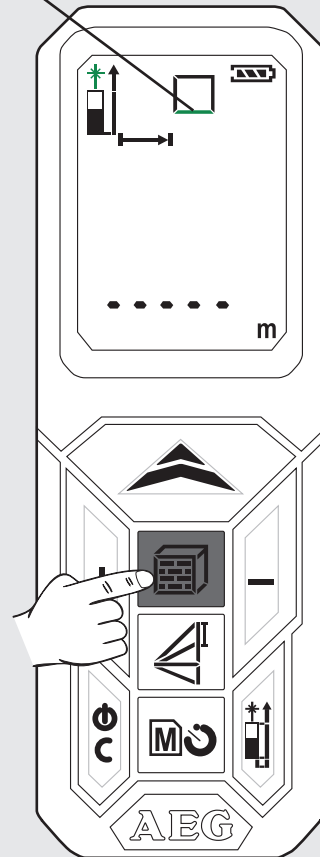
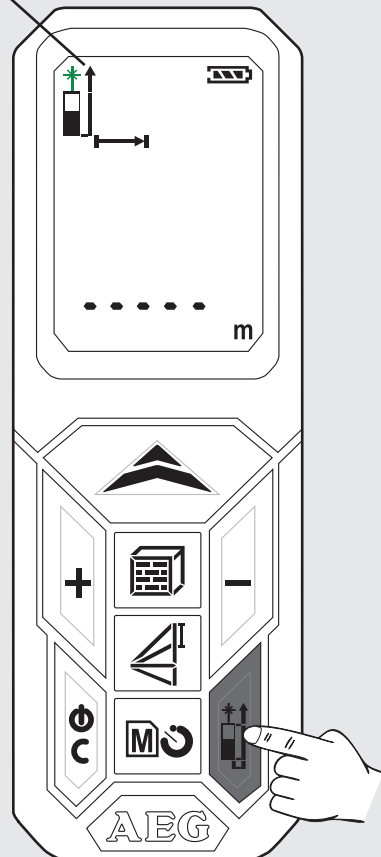
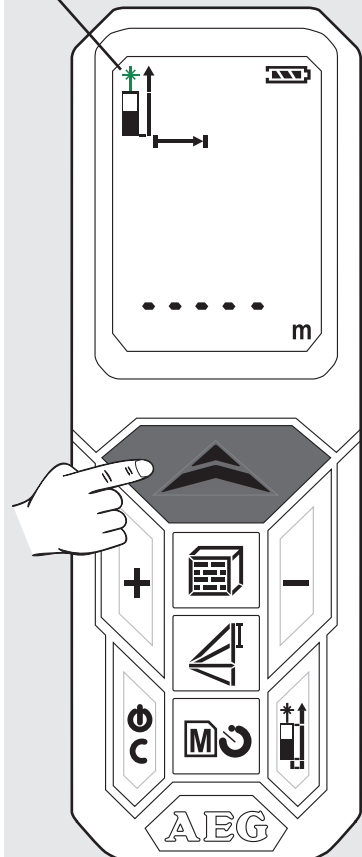

6 Εμφάνιση αποθηκευμένων τιμών

Πιέστε το πλήκτρο  για 2 δευτερόλεπτα.

Πιέστε το πλήκτρο + ή -

- Οι αποθηκευμένες τιμές εμφανίζονται στην κύρια γραμμή.

- Εμφανίζεται το αντίστοιχο σύμβολο και το μέγεθος μέτρησης αναβοσβήνει (στην εικόνα το πράσινο σύμβολο)

7 Έξοδος από την μνήμη

Πιέστε το πλήκτρο 

8 Απενεργοποίηση

Πιέστε το πλήκτρο  για 2 δευτερόλεπτα
(Πριν αυτού πρέπει να έχετε βγει από την λειτουργία μνήμης)

- Η συσκευή σβήνει.

- Αν δεν πιέσετε κάποιο πλήκτρο για 3 λεπτά, η συσκευή απενεργοποιείται αυτόματα.

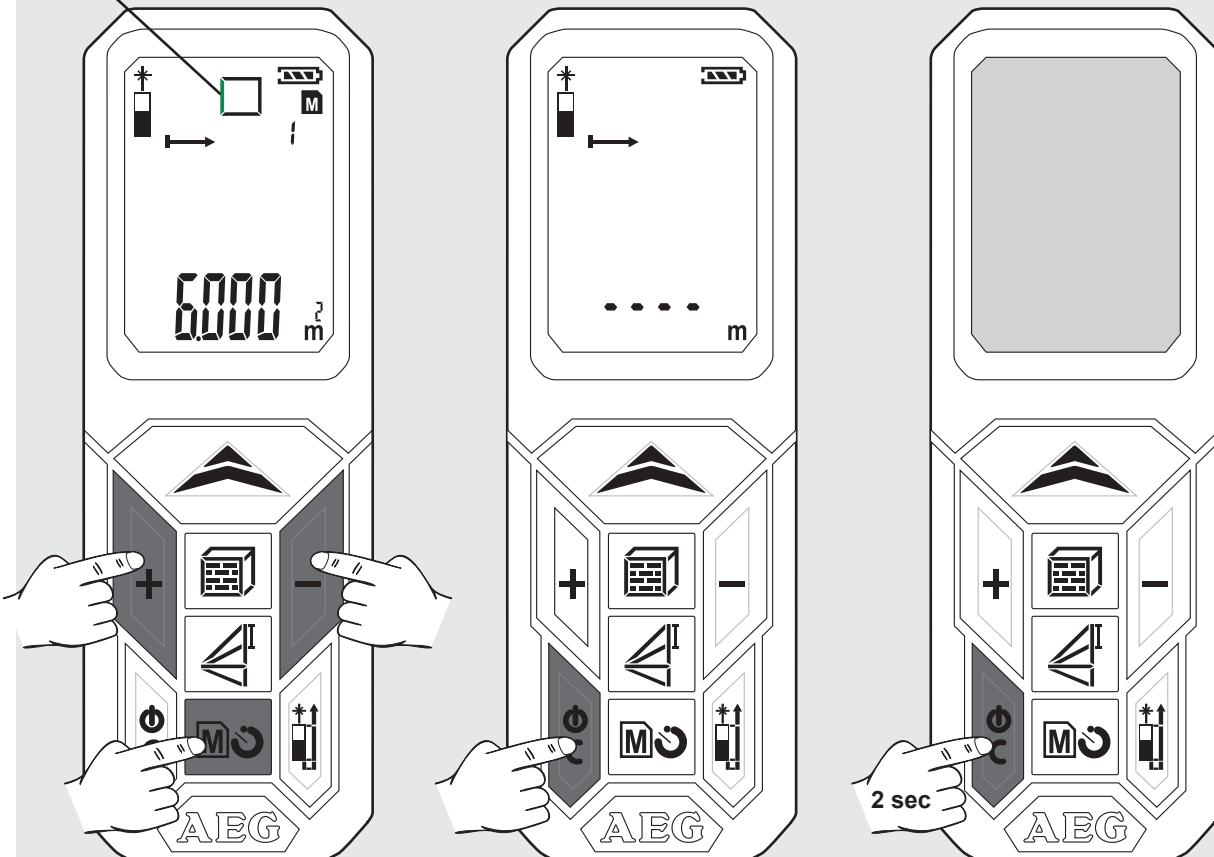

İÇİNDEKİLER

Önemli Emniyet Talimatnamesi	1
Teknik veriler	2
Kullanım	2
Hata Kodu Tablosu	2
Genel Bakış	3
Pillerin değiştirilmesi	4
Köşe Pimi	4
Kemer Klipsi	4
Fonksiyon Düğmesi, Pisagor, Ölçüm Referansı	5
Münferit Mesafe Ölçümü	6
Sürekli / Minimum-Maksimum Ölçüm	7
Ekleme / Çıkarmalı Ölçüm	8
Alan Ölçümü	9
Hacim Ölçümü	10
Dolaylı Ölçüm (Pisagor 1)	11
Dolaylı Ölçüm (Pisagor 2)	12
Dolaylı Ölçüm (Pisagor 3)	13
Duvar Alanı Ölçümü (Senaryo 1)	14
Duvar Alanı Ölçümü (Senaryo 2)	15
Zamanlayıcı	16
Bellek	16
Alan ölçümü örneği (1) ile ilgili Temel Açıklama	17
Alan ölçümü örneği (2) ile ilgili Temel Açıklama	18

ÖNEMLİ EMNİYET TALIMATNAMESİ



Ürünle birlikte verilen CD'deki Emniyet talimatnamesini ve Kullanma kılavuzunu okumadan önce ürünü kullanmayın.

Lazer Sınıfı

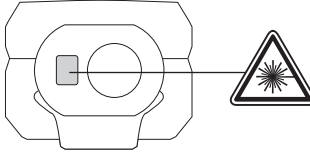

İKAZ:

Bu ürün, IEC 60825-1:2007 standardına göre, **Sınıf 2** lazer kategorisine girer.



Etiket

İlk defa çalıştırmaya başlamadan önce birlikte gönderilen yapıştırıcı ile kendi ülke lisanınızda İngilizce metni verim tabelasının üzerine yapıştırınız.

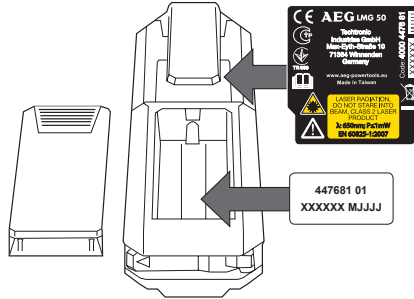

Uyarı:

Doğrudan ışına bakmayınız. Lazer ışını ışık körlüğüne yol açabilir.

Gözünüzü, gereksiz yere lazer ışınına dikmeyiniz ve bu ışınları başkalarının üzerine tutmayınız.

Diğer şahıslara yöneltmeyin.

Uyarı:

Lazer cihazını çocukların yakınında kullanmayın veya çocukların lazer cihazını kullanmalarına izin vermeyin.

Dikkat! Yansıma yapan bir yüzey lazer ışını kullanıcıya veya başka kişilere geri yansıtabilir.

Dönen parçalarla aranızda emniyetli bir mesafe bulundurun.

Periyodik olarak denetleme ölçümleri yapın. Özellikle, önemli ölçümleri yapmadan önce, yaparken ve yaptıktan sonra.

Cihazın düşürülmesinden veya uygun olmayan alanda kullanılmasından ya da üzerinde yapılan değişiklikten kaynaklanan bir arıza sebebiyle, hatalı ölçümlerden sakınız.

Dikat! Bahçe aletinin usulüne uygun olarak kullanımını ve kumanda elemanlarının işlevlerini tam olarak öğrenin.

Lazerli mesafe ölçerinin kullanımıyla ilgili sınırlar vardır. (Bkz. "Teknik Veriler" bölümü). Maksimum ve minimum aralık dışındaki ölçüm denemeleri yanlış sonuçlara neden olacaktır. Çok sıcak, çok soğuk, çok parlak güneş ışığı, yağmur, kar, sis veya diğer görüşü kısıtlayan koşullar gibi olumsuz koşullarda kullanım, yanlış ölçüm değerlerinin elde edilmesine yol açacaktır.

Lazerli mesafe ölçer çok soğuk koşullardan sıcak bir ortama getirilirse veya tam tersi bir durumda, kullanımdan önce cihaz ortam sıcaklığına gelene kadar bekleyiniz.

Lazerli mesafe ölçeri daima kapalı ortamda saklayınız, cihazı şok, sürekli titreşim veya aşırı sıcaklıklara maruz bırakmayınız. Aleti daima toz, sıvılar ve yüksek nem koşullarından uzakta tutunuz. Bunlar, iç bileşenlere zarar verebilir veya doğruluk hassasiyetini etkileyebilir.

Aşındırıcı temizlik maddeleri veya çözeltilerini kullanmayınız. Temizlik için yalnızca temiz, yumuşak bir bez kullanınız.

Ölçüm aletinin ağır bir darbeye uğramasını veya yere düşmesini önleyiniz. Cihaz yere düşürülmüşse veya diğer mekanik gerilmelere maruz kalmışsa, kullanımdan önce aletin doğruluğu kontrol edilmelidir.

Bu lazer cihazında gerekli olan tamirler sadece yetkili servis personeli tarafından yapılabilir.

Agresif veya patlayıcı ortamlarda çalıştırmayın.

Bataryaları şarj etmek için sadece imalatçı tarafından önerilen şarj cihazını kullanın.



Bitmiş piller, evsel atıkla birlikte elden çıkarılmamalıdır. Çevreye karşı gereken özeni göstererek, bitmiş pilleri ulusal ya da yerel yönetmeliklere uygun olarak temin edilen atık toplama merkezlerine bırakın. Ürün, evsel atıkla birlikte elden çıkarılmamalıdır. Ürünü ülkenizde yürürlükte bulunan ulusal yönetmeliklere uygun olarak elden çıkarın.

Ulusal ve spesifik yönetmeliklere göre hareket edin. Elden çıkarılmalarıyla ilgili bilgiler almak için mahalli makama veya satıcınıza başvurun.



TEKNİK VERİLER

Toz ve Su direnci	IP54
Alıcı Mercekler	14 mm
Odak noktası	35 mm
Maksimum Ölçüm Aralığı	50 metre (Tolerans: 55m)
Minimum Ölçüm Aralığı	0.05 metre
< 10m'de Mutlak Ölçüm Hassasiyeti	± 1.5 mm (Maks.)
< 10m'de Tekrar Elde Edilebilir Hassasiyet	± 1.5 mm (Maks. Tipik 2σ)
> 10m'de Tekrar Elde Edilebilir Hassasiyet	Artış ± 0.25 mm / metre (Maks. Tipik 2σ)
Ölçme Süresi	0.5 sn.
Ekran Tipi	LCD (22.7 mm x 31 mm)
Güç Türü	AAA 2x (Kalem PİL)
Pil Ömrü	10000 (Münferit Ölçüm)
Lazer Çıkış Gücü	0.6 mW ~ 0.95 mW (Sınıfı 2, 650nm)
Lazer Hedef Noktası Büyüklüğü	25 x 30 mm @ 16 m (Maks.)
Lazer Işınımı Düşey Açısı	+1 derece
Lazer Işınımı Yatay Açısı	±1 derece
Cihazın otomatik kapanma süresi	180 saniye
Lazerin otomatik kapanma süresi	30 saniye
Çalışma Sıcaklığı Aralığı	-10°C ila +50°C
Saklama Sıcaklığı Aralığı	-25°C ila +70°C
Pilsiz Ağırlığı	80 g

KULLANIM

Lazerli mesafe ölçer, uzaklıklar ve eğimlerin ölçümü için kullanılabilir.
Bu alet sadece belirtildiği gibi ve usulüne uygun olarak kullanılabilir.

HATA KODU TABLOSU

Kod	Tanım	Çözüm
Hata01	Ölçüm aralığı dışında	Uygun bir aralıkta ölçüm yapın
Hata02	Alınan sinyal çok zayıf	Daha iyi bir yüzey seçin
Hata03	Görüntüleme aralığı dışında(maks. değer: 99.999) yani alan veya hacim sonucu ekranda görüntülenemiyor	Değerlerin ve adımları kontrol edin ve doğru olduklarından emin olun
Hata04	Pisagor hesaplama hatası	Değerler ve adımları kontrol edin ve doğru olduklarından emin olun
Hata05	Pil zayıf	Yeni piller takın
Hata06	Çalışma sıcaklığı dışında	Belirtilen çalışma sıcaklığındaki bir ortamda ölçüm yapın
Hata07	Ortam ışığı çok güçlü	Daha karanlık bir yerde ölçüm yapın (hedefe gölge yapın)

Pisagor
Yükseklik farkı

Ölçüm Referansı

Normal Ölçüm Modu

Sürekli Ölçüm için Minimum / Maksimum

Ekleme / Çıkarma

Alan/ Hacim
Dolaylı Yüzey Ölçümü

Pil Durumu

Bellek

Zamanlayıcı

Sürekli ölçüm modu

Değerler Arası

Ana Değer

AÇIK / ÖLÇÜM

- ▶ Açık
- ▶ Ölçüm
- ▶ Sürekli Ölçüm (2 sn basın)
+ Min / Maks. Fonksiyonu

EKLE

- ▶ Değer ekle
- ▶ Bellek menüsünde gezin

ALANLAR / HACİMLER

- ▶ Alan (1 kez basın)
- ▶ Hacim (2 kez basın)
- ▶ Dolaylı Yüzey Ölçümü (3 kez / 4 kez basın)

GÜÇ

- ▶ Açık
- ▶ Kapalı (2 sn basın)
- ▶ Sil

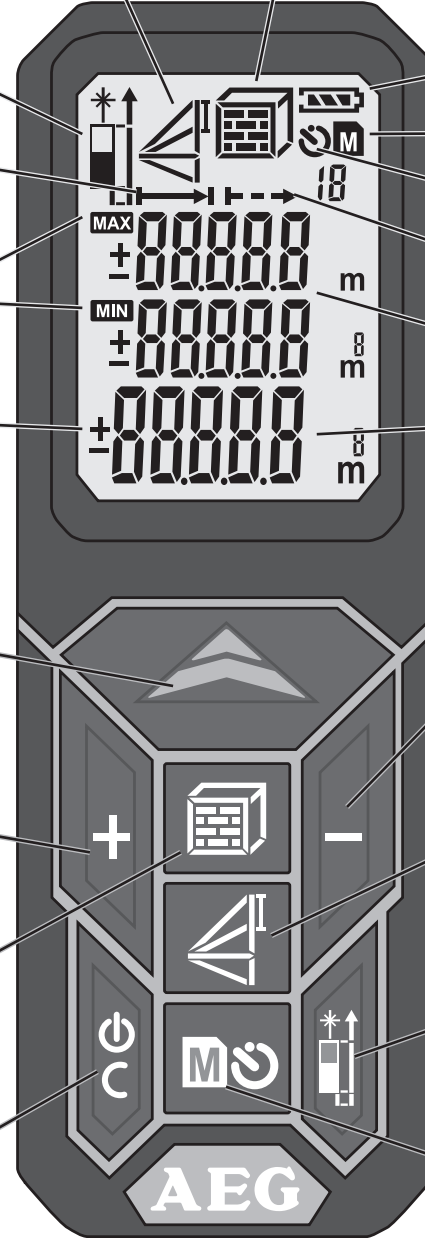

ÇIKAR

- ▶ Değer çıkar
- ▶ Bellek menüsünde gezin

PISAGOR

- ▶ Pisagor 1 (1 kez basın)
- ▶ Pisagor 2 (2 kez basın)
- ▶ Pisagor 3 (3 kez basın)

ÖLÇÜM NOKTASINI DEĞİŞTİR

- ▶ Ön
- ▶ Arka (Standart otomatik)
- ▶ Köşe pimi

BELLEK

- ▶ Zamanlayıcı 3-15 sn (1 kez basın)
- ▶ Bellek 1-20 (1 kez, 2 sn basın)
- ▶ Bellekteki ölçümlerde gezinmek için, +/-'yi kullanın

PİLLERİN DEĞİŞTİRİLMESİ

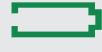
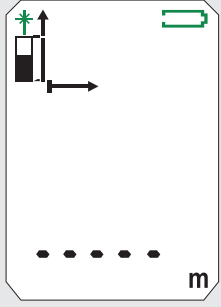

Pil işareti yanıp söndüğünde pilleri değiştirin.

1

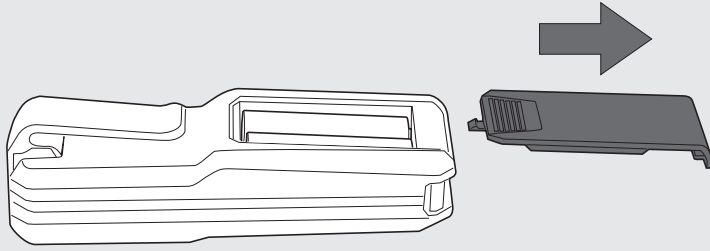

2

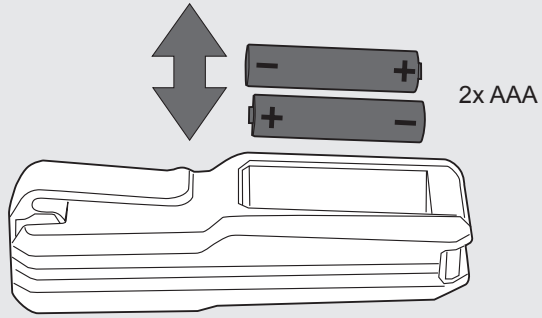

3

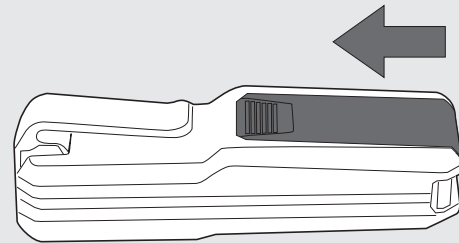

KÖŞE PİMİ

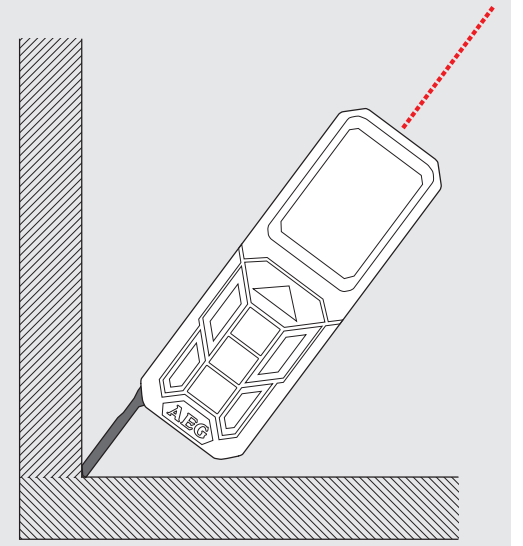
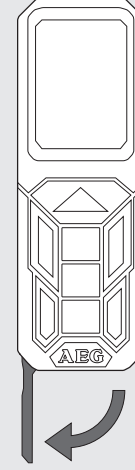

KEMER KLİPSİ

1

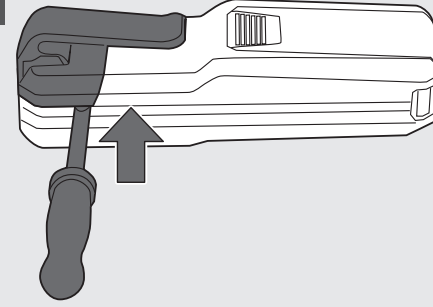

2

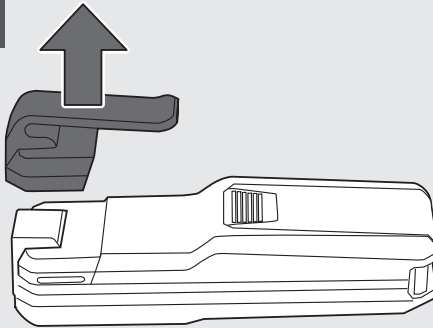

3

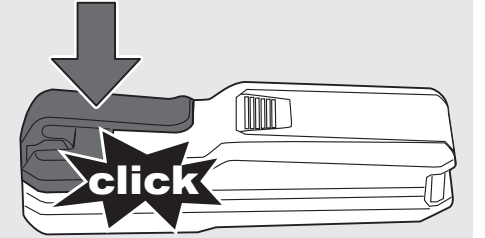

FONKSİYON DÜĞMESİ, PISAGOR, ÖLÇÜM REFERANSI

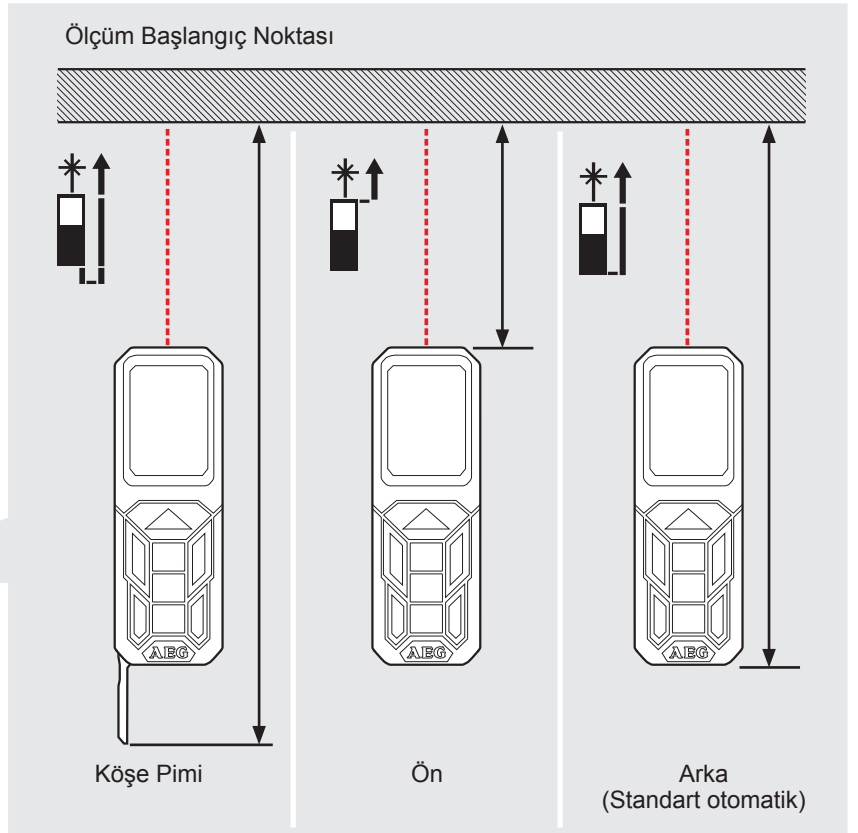
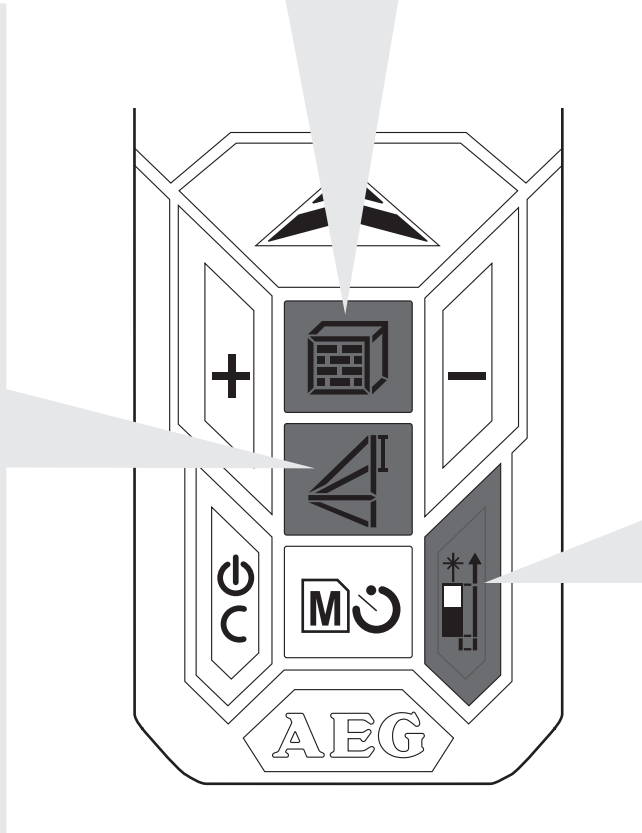
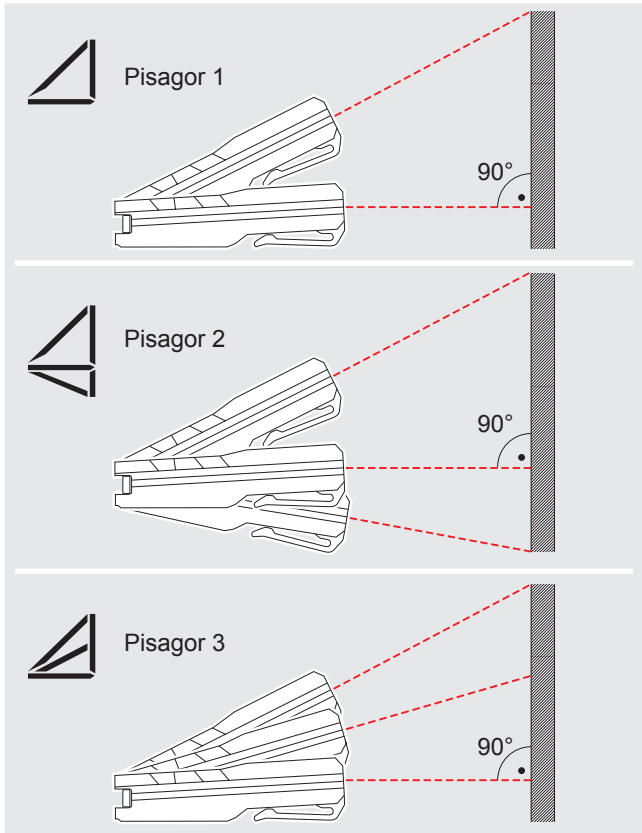
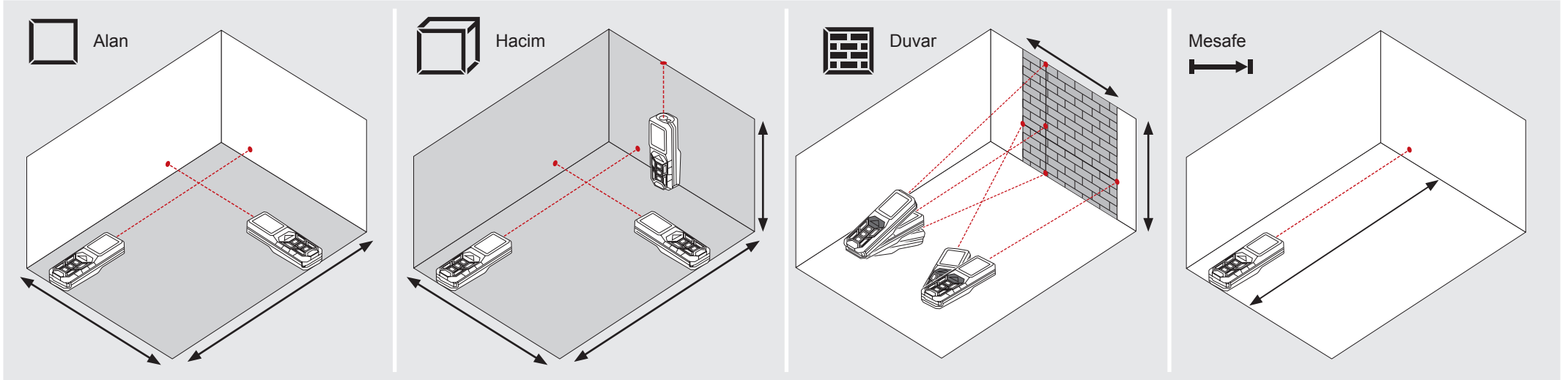

MÜNFERIT MESAFE ÖLÇÜMÜ

0

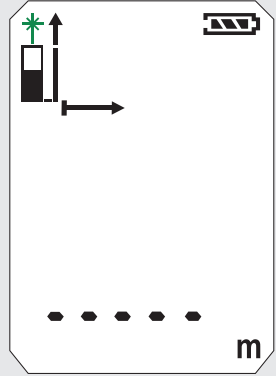

1

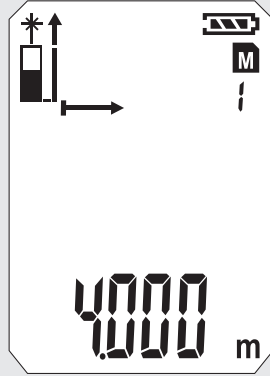
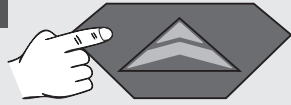

2

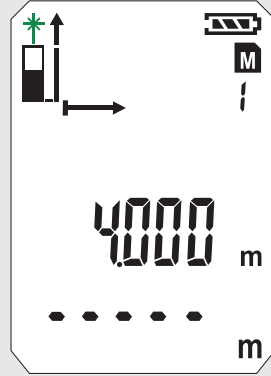
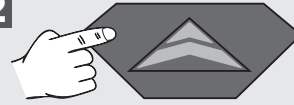

3

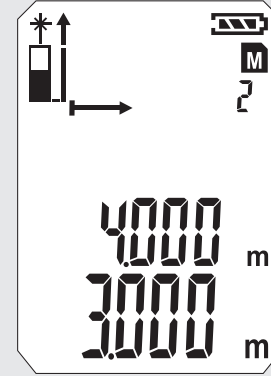
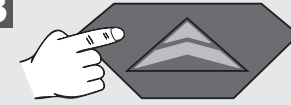

4

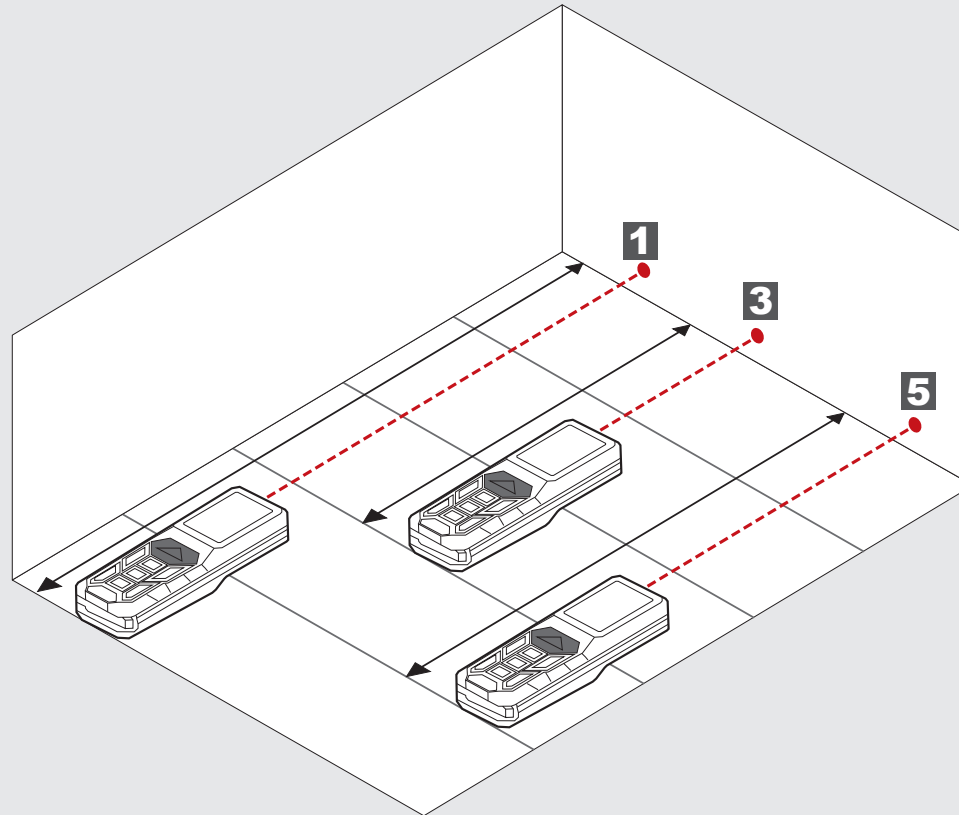
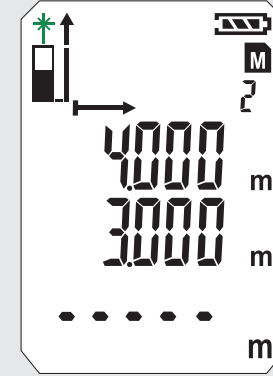
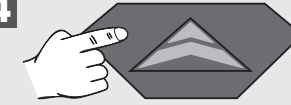

5

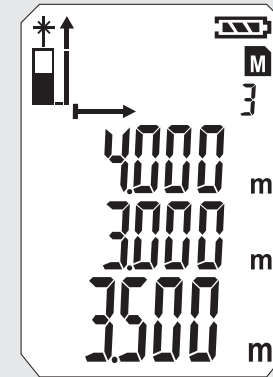
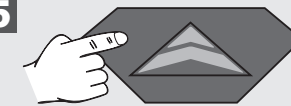

SÜREKLİ / MINIMUM-MAKSİMUM ÖLÇÜM

0

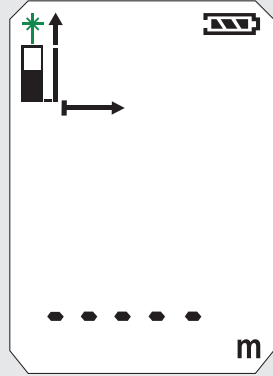

1

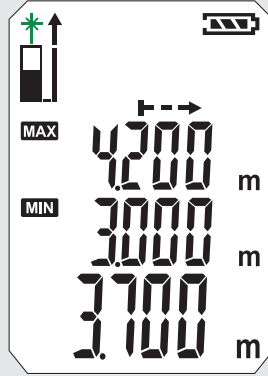
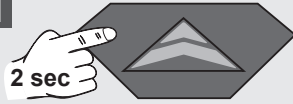

2

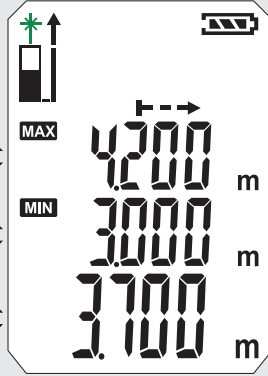
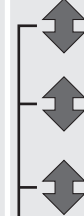

3

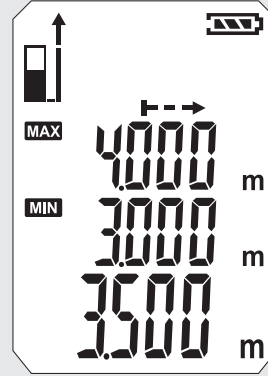
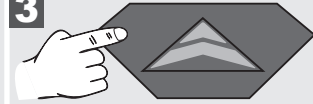

4

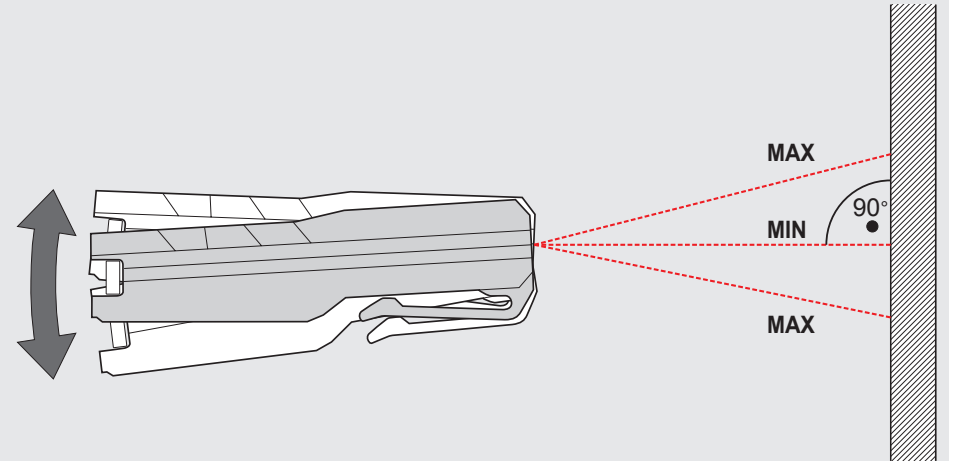
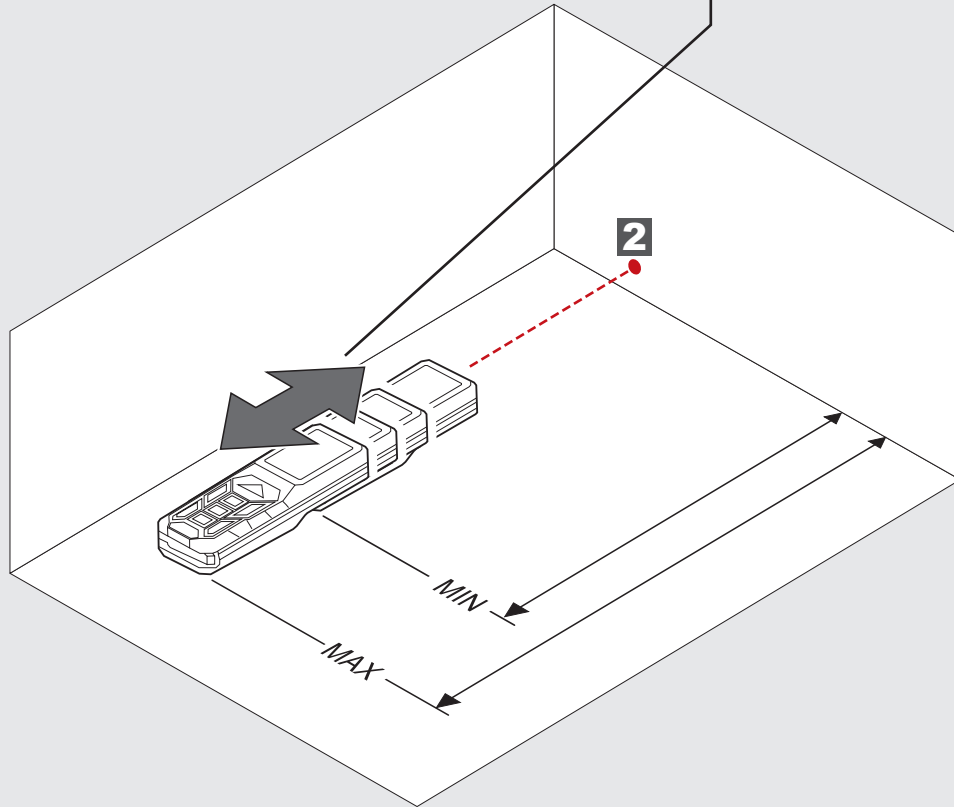
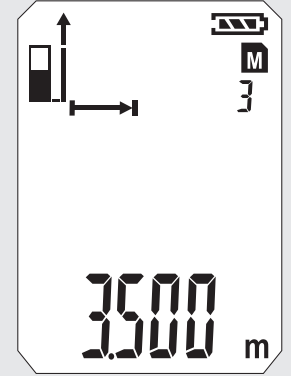
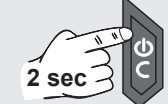

0

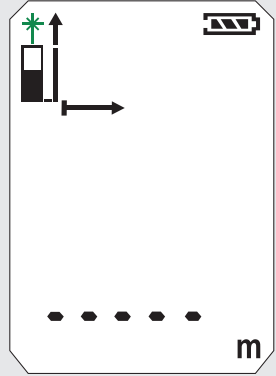

1

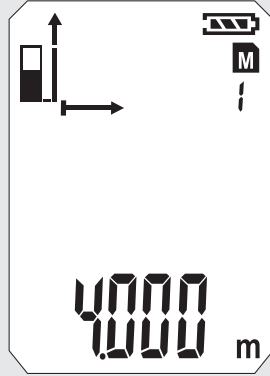
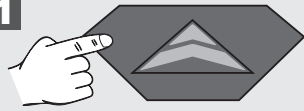

2

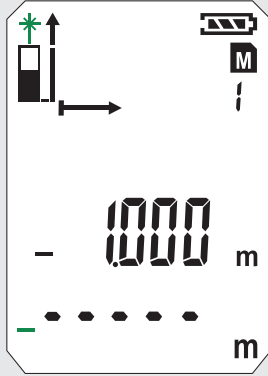
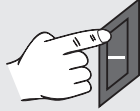

3

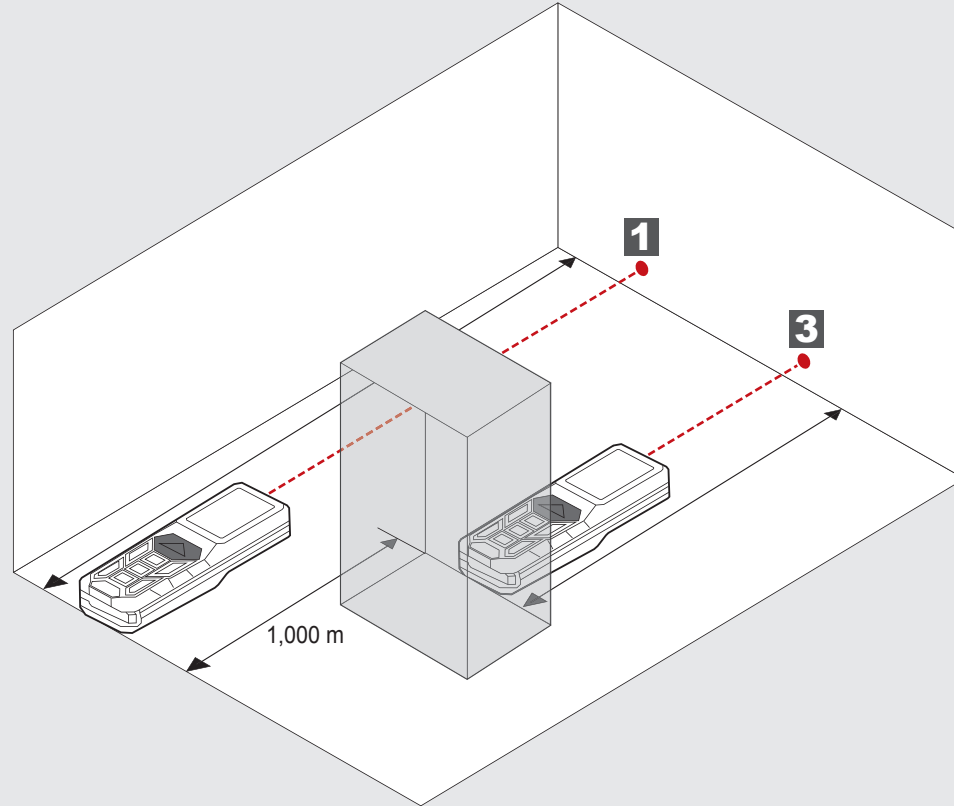
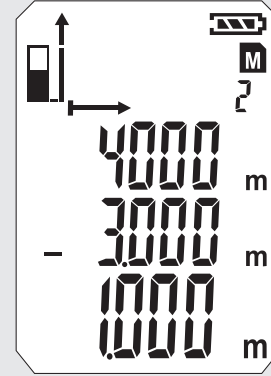
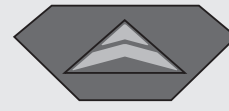

ALAN ÖLÇÜMÜ

0



1

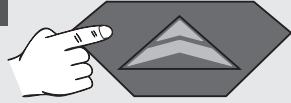

2

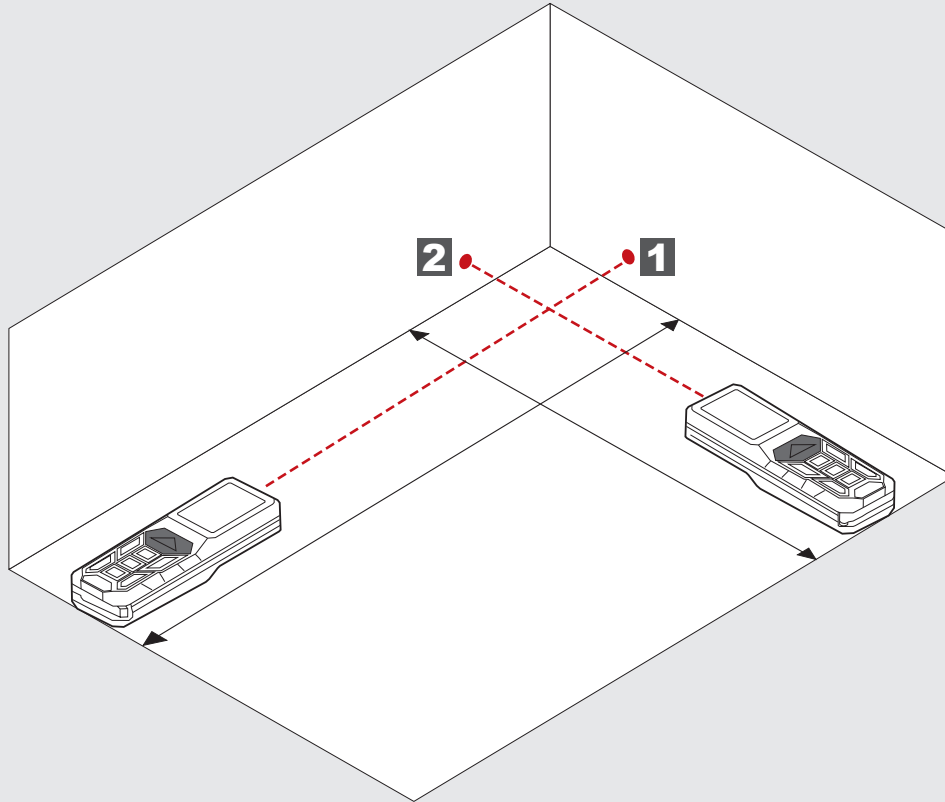
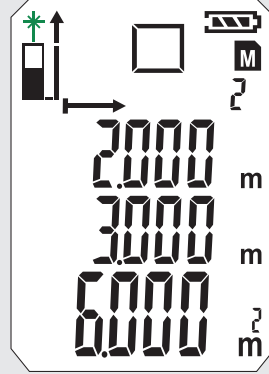
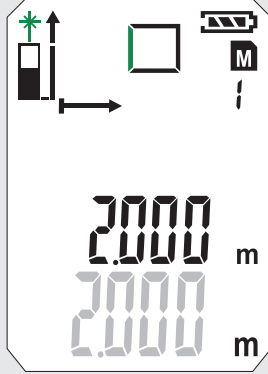
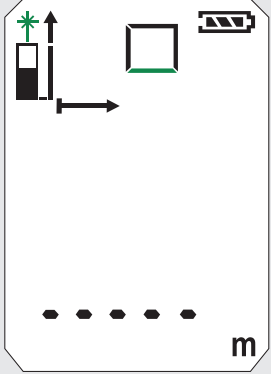
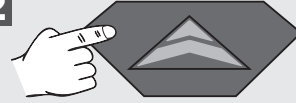

HACİM ÖLÇÜMÜ

0



1

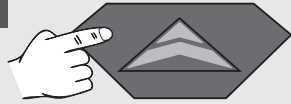

2

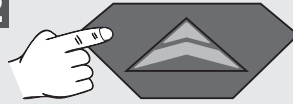

3

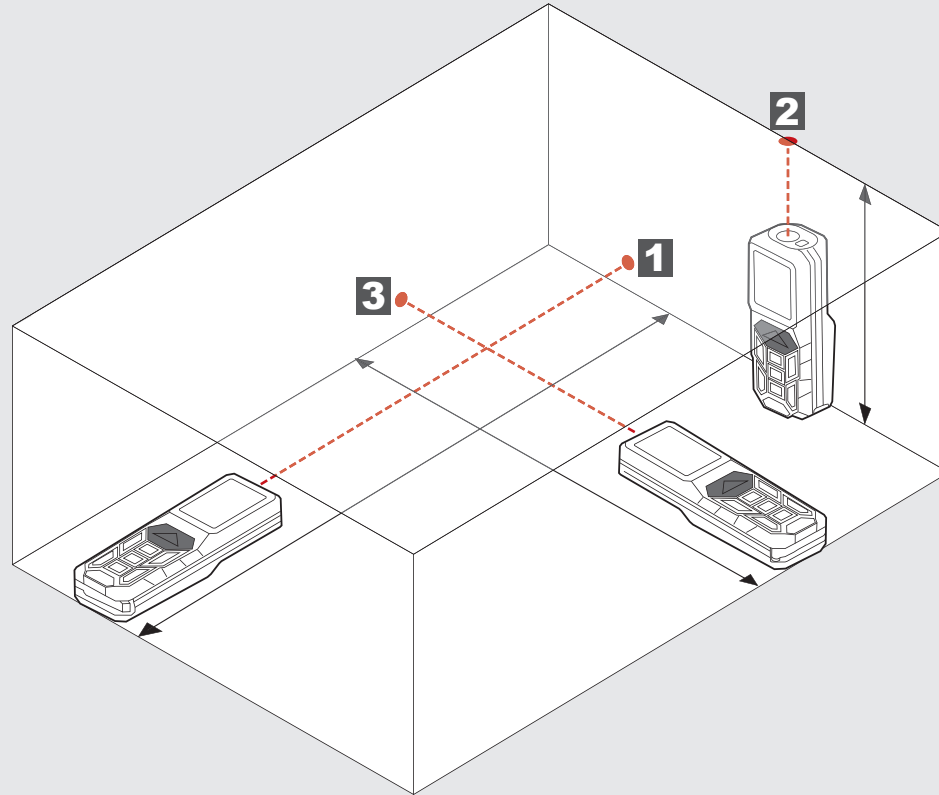
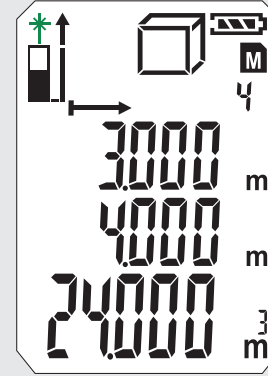
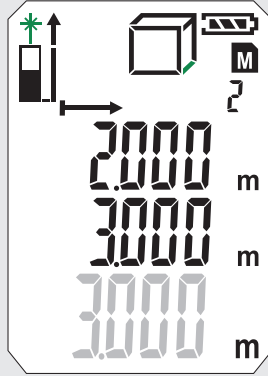
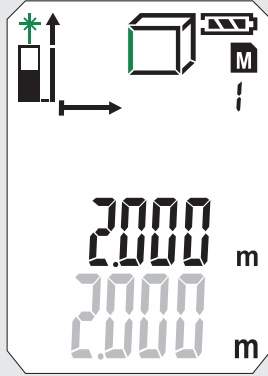
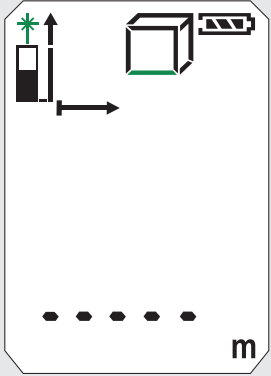
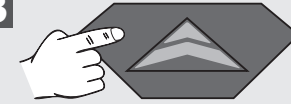

DOLAYLI ÖLÇÜM (PISAGOR 1)

0



1

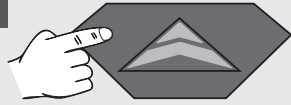

2

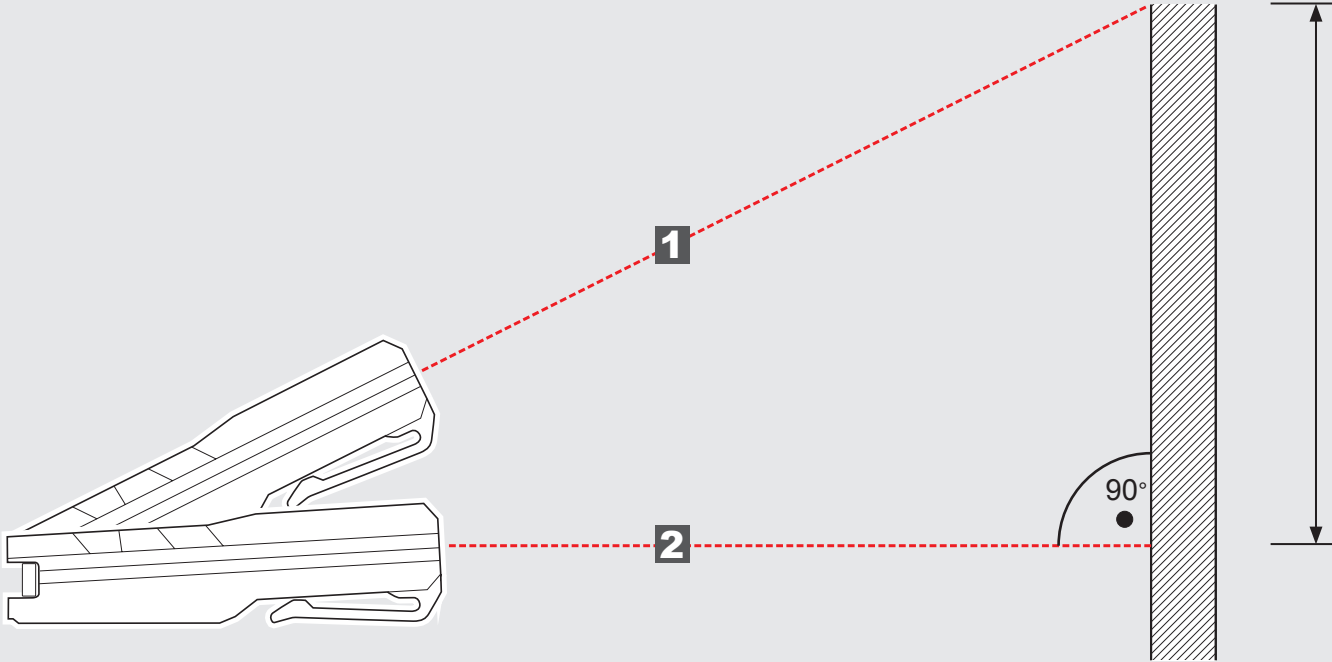
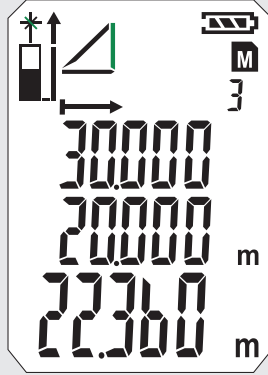
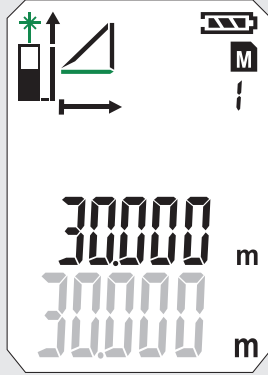
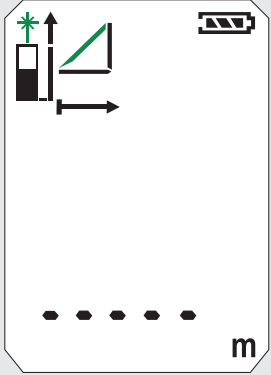
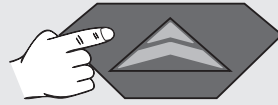

DOLAYLI ÖLÇÜM (PISAGOR 2)

0

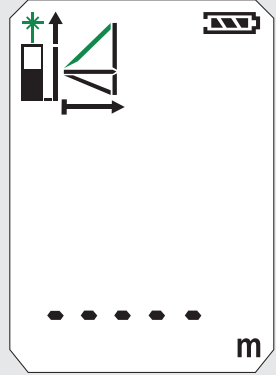

1

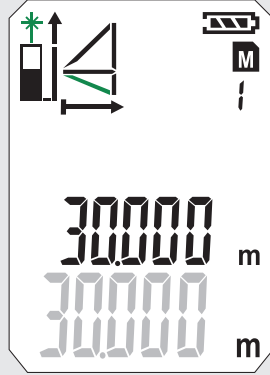
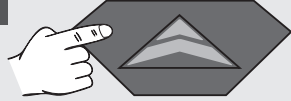

2

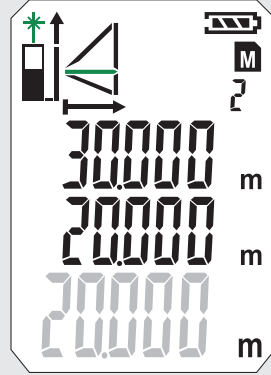

3

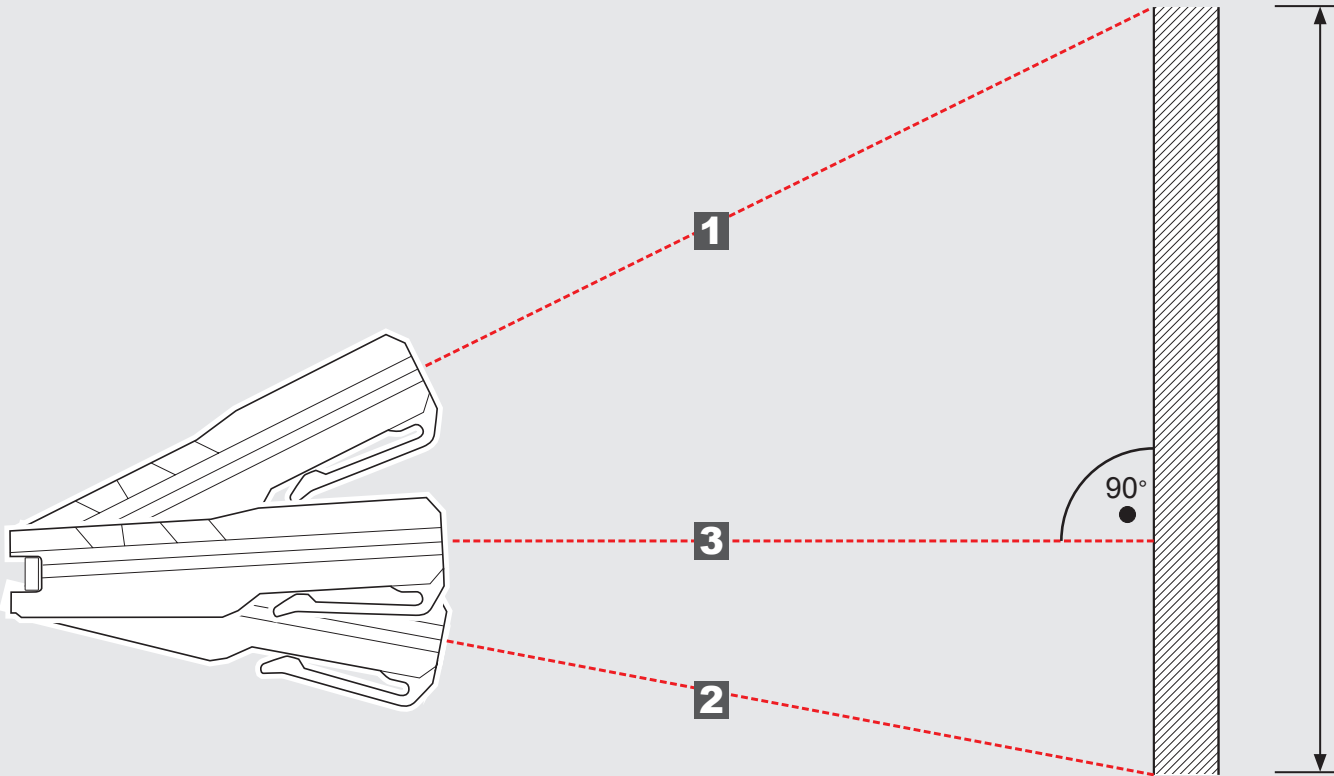
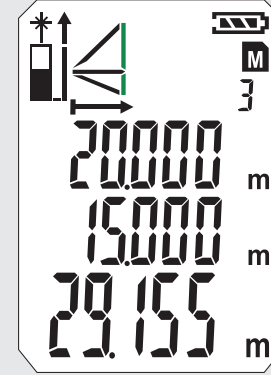

DOLAYLI ÖLÇÜM (PISAGOR 3)

1

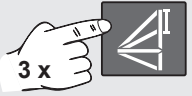

2

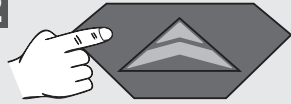

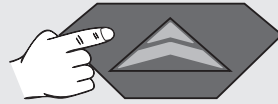

3



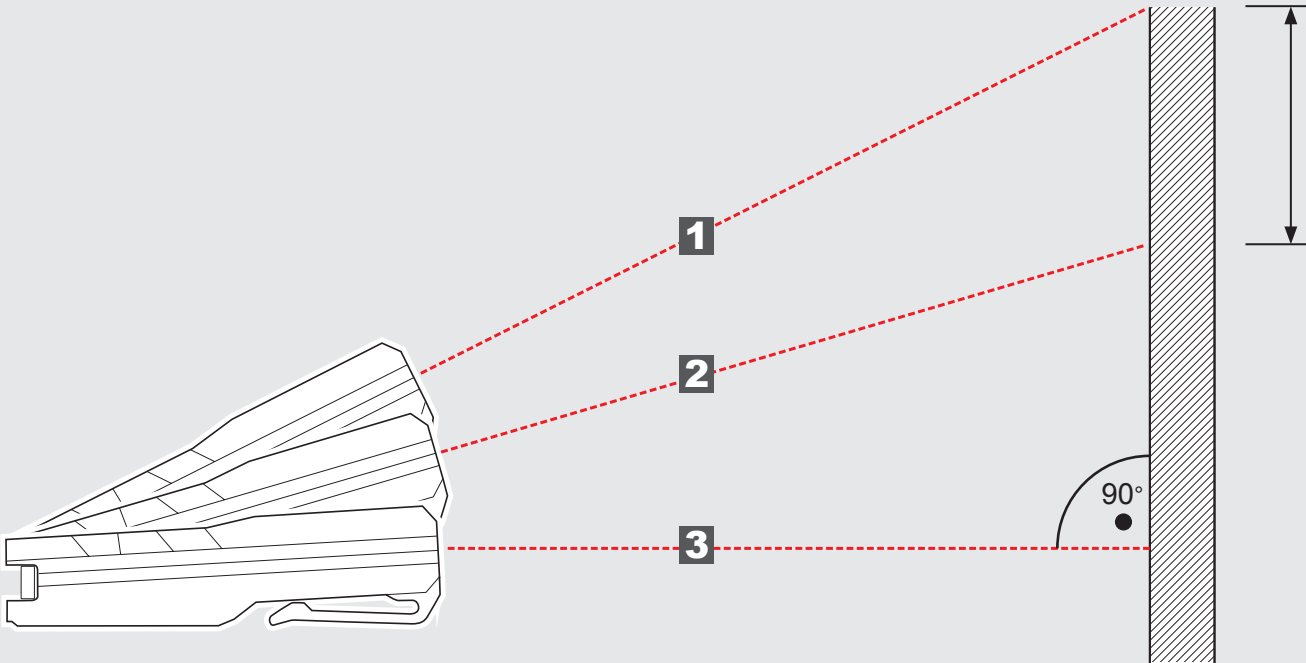
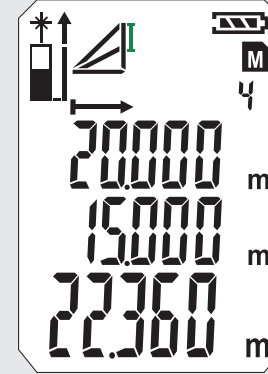
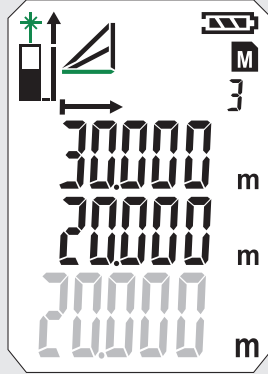
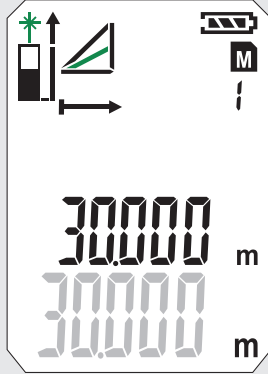
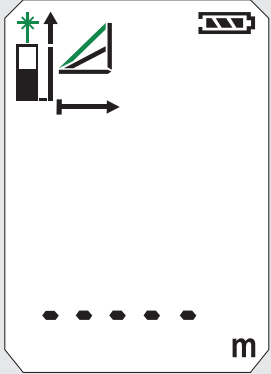
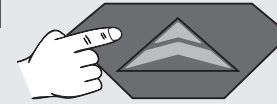

4



DUVAR ALANI ÖLÇÜMÜ (SENARYO 1)

0  

1 

2 

3 

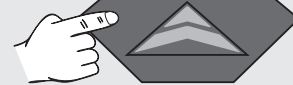
4 

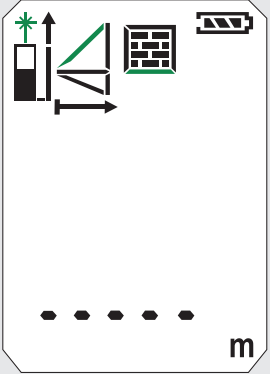

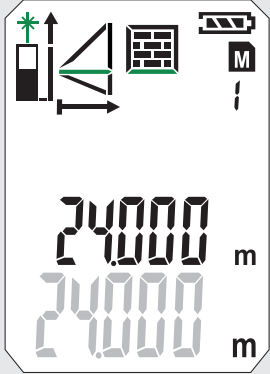

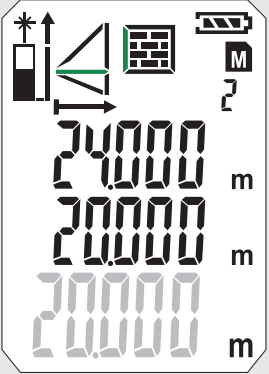

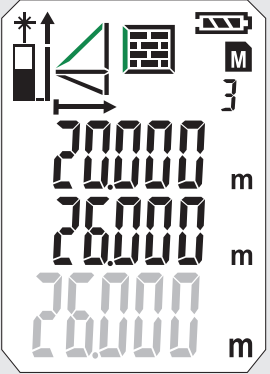

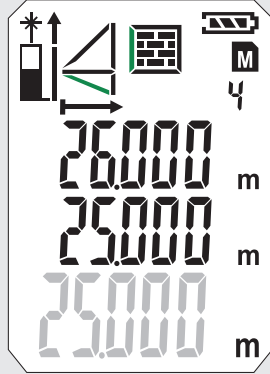

5 

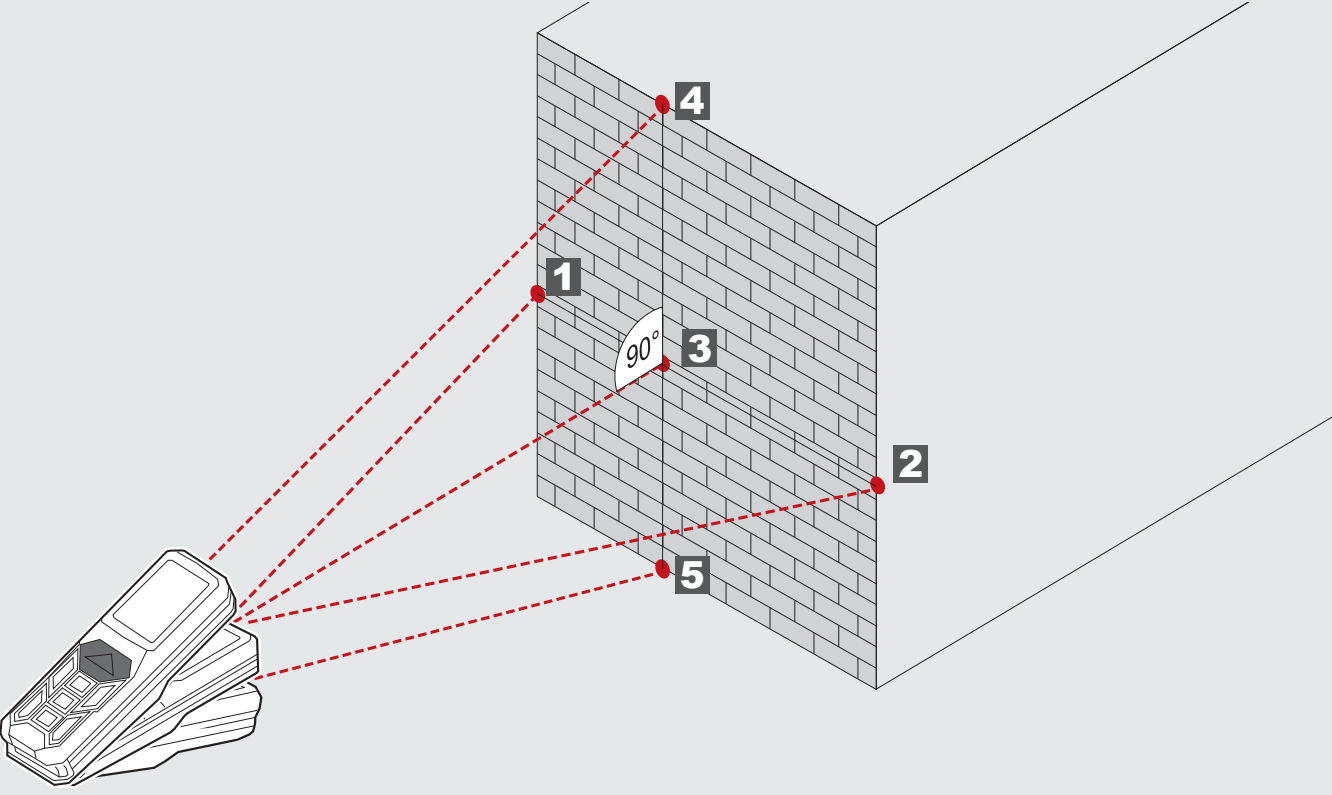

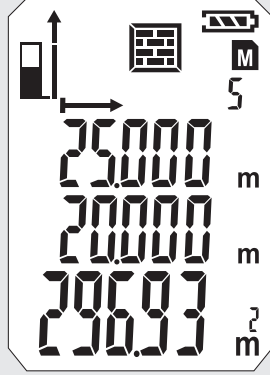

DUVAR ALANI ÖLÇÜMÜ (SENARYO 2)

0

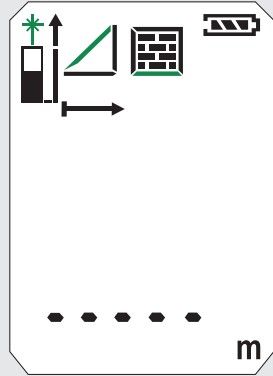

1

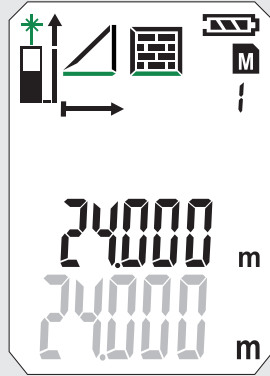
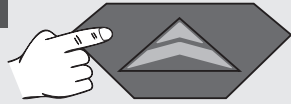

2

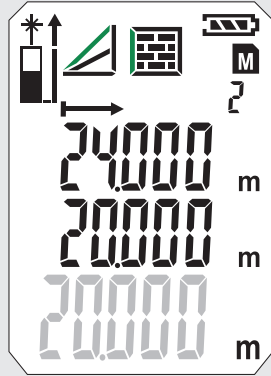
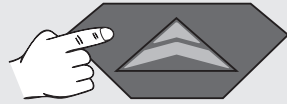

3

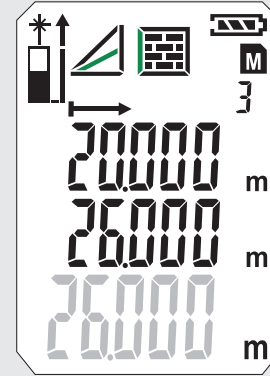
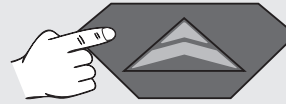

4

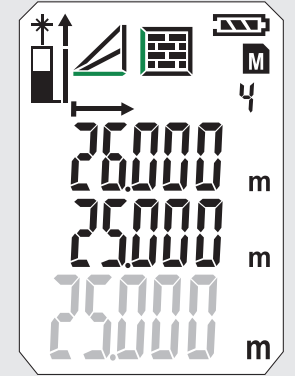
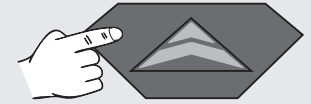

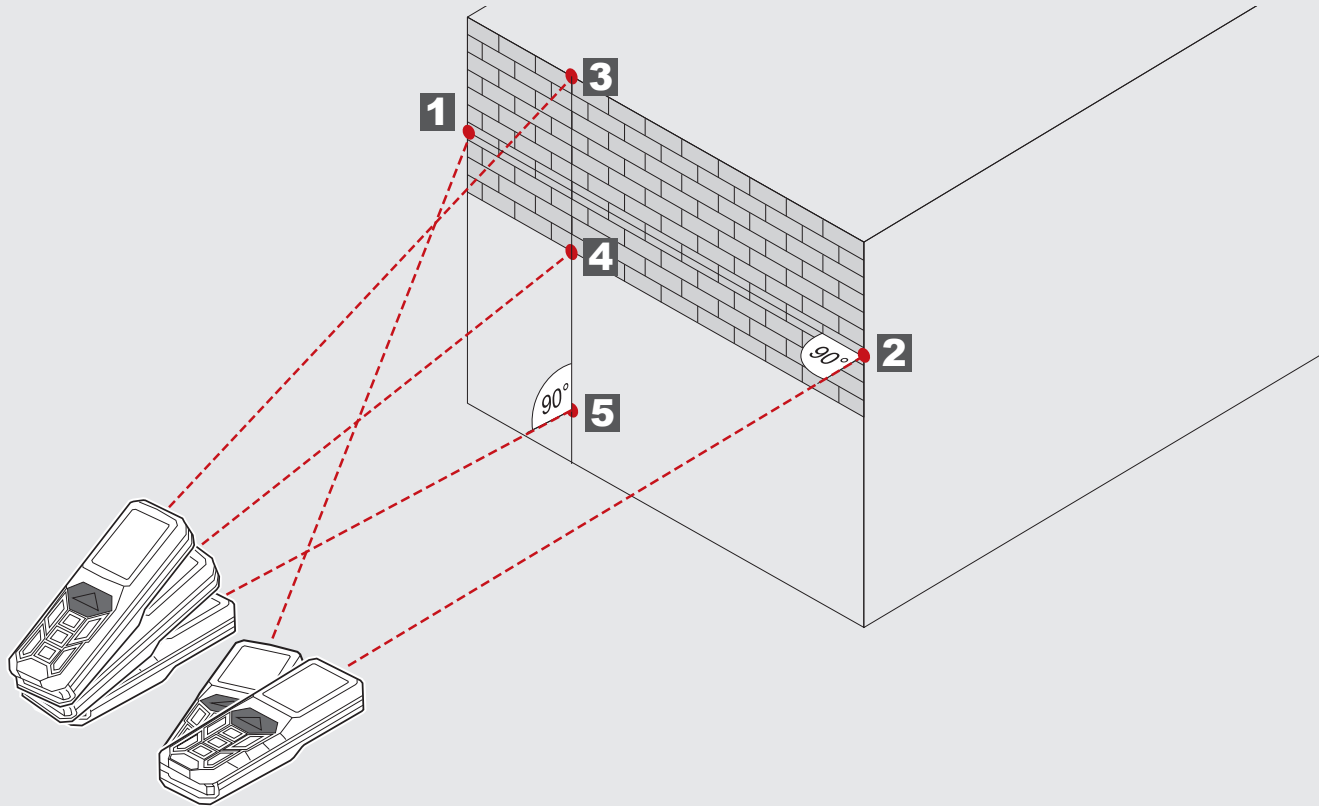
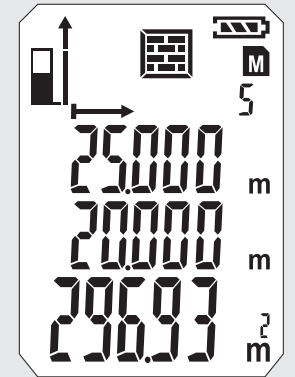
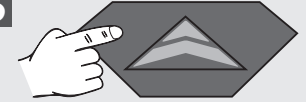

5



ZAMANLAYICI

Zamanlayıcı ile ölçüm geç başlatılabilir. Örneğin, ölçüm ışınına bir parçanın yerleştirilmesi için.

 (bellek) düğmesine bas

- Simge görüntülenir. Zamanlayıcı,  düğmesine basılarak, 3 ila 15 sn aralığında ayarlanabilir.

 düğmesine bas

- Ölçüm başlayana kadar saniyeler geriye doğru sayılır.
- 0'da ölçüm başlar.

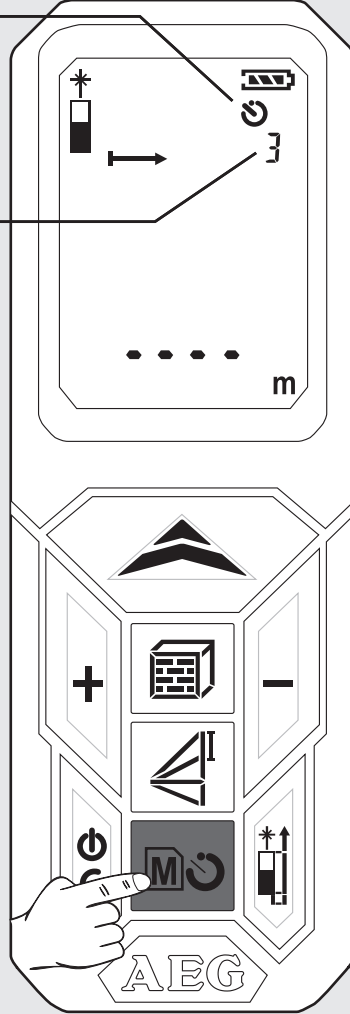

BELLEK

Ölçülen değerler, sürekli ve otomatik olarak bellekte kaydedilir.

Kaydedilen değerlere  (bellek) düğmesine basılarak ulaşılabilir.

 (bellek) düğmesine 2 sn basın.

- Simge ve bellek sayısı ekranda görünür.
- İlişkili ölçülmüş parametre gösterilir.
- Kaydedilmiş değer, ana satırda gösterilir.
- + / - düğmeleriyle gezinir.

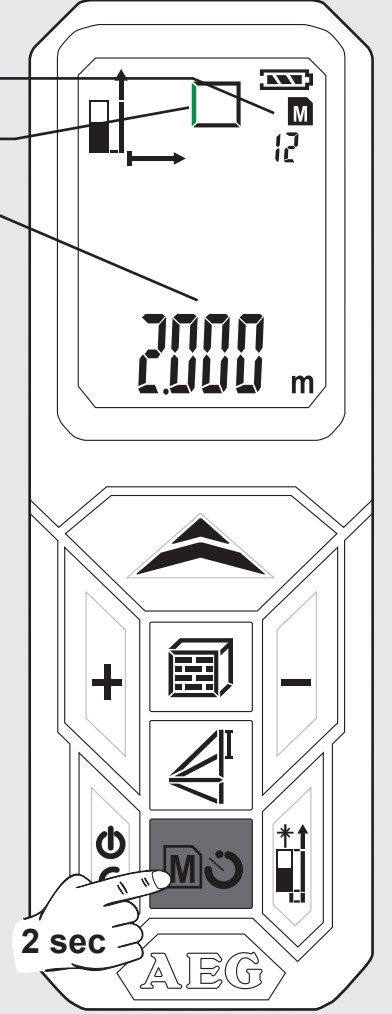

ALAN ÖLÇÜMÜ ÖRNEĞİ (1) İLE İLGİLİ TEMEL AÇIKLAMA

1 Cihazı Aç

Düğmesine bas
⚠ Dikkat! Lazer açık!
Başkasına doğrultmayın!

Lazer simgesi yanıp söner
(yanıp sönen yeşil ışıkla
gösterilir).

2 Ölçüm Aralığını Seç

Cihazın açılmasından sonra
standart: Alt
↑ 1 kez basın -> Köşe Pimi
↑ 2 kez basın -> Üst
↑ 3 kez basın -> Alt

Simge görüntülenir.

3 Fonksiyonu Seç

Cihaz açıldıktan sonra daima
münferit mesafe ölçümüne ayarlıdır
☰ 1 kez basın - Alan Ölçümü.

- Simge görüntülenir.
- Ölçülen parametre yanıp söner
(yanıp sönen yeşil ışıkla gösterilir)

4 Uzunluğu ölç

Cihazı hedefe
doğru yönelt ve
↗ düğmesine bas.

- Ölçülen değer kısa bir süre için
ana satırda görüntülenir.
- Ölçülen değer, yukarıdaki satırda
1 saniye atlar.
- Ölçülen değer, ardışık sayılar
halinde belleğe kaydedilir.
- İkinci ölçülen parametre yanıp
söner. Cihaz ikinci değer
ölçümü için hazırdır.

5 Genişliği ölç

Cihazı hedefe doğru
yönelt ve
↖ düğmesine bas

- Ölçülen değer kısa bir süre için alt
satırda görüntülenir.
- Ölçülen değer, yukarıdaki satırda
1 saniye atlar.
- Ölçülen değer, ardışık sayılar
halinde belleğe kaydedilir.
- Sonuç ana satırda görüntülenir ve
ardışık sayılar halinde belleğe
kaydedilir.

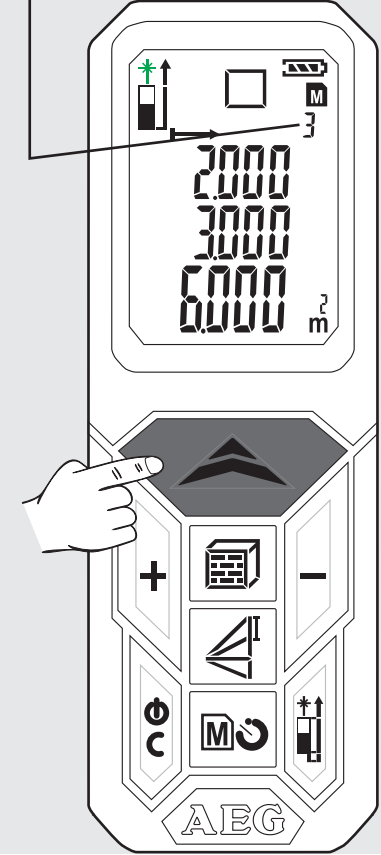
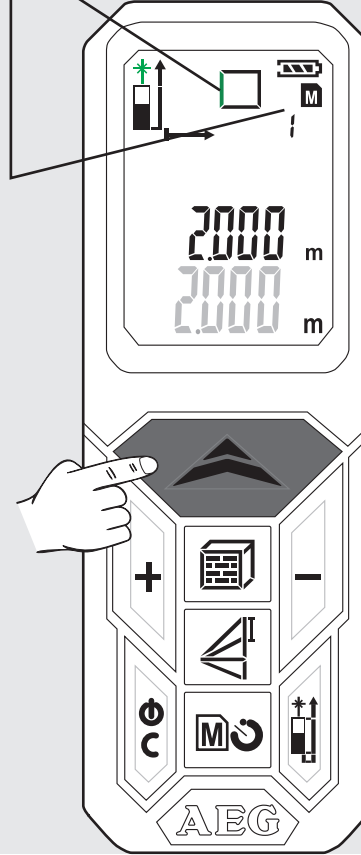
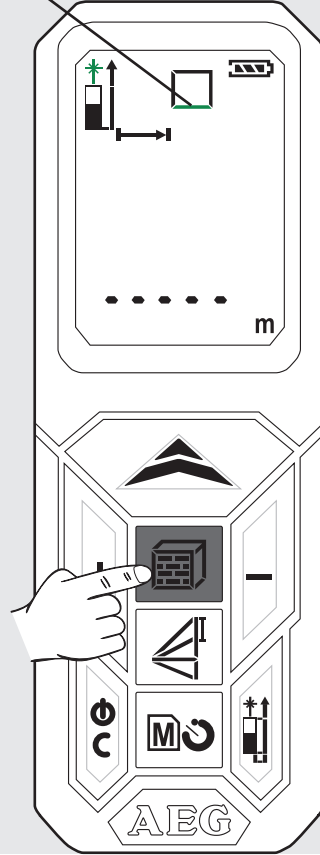
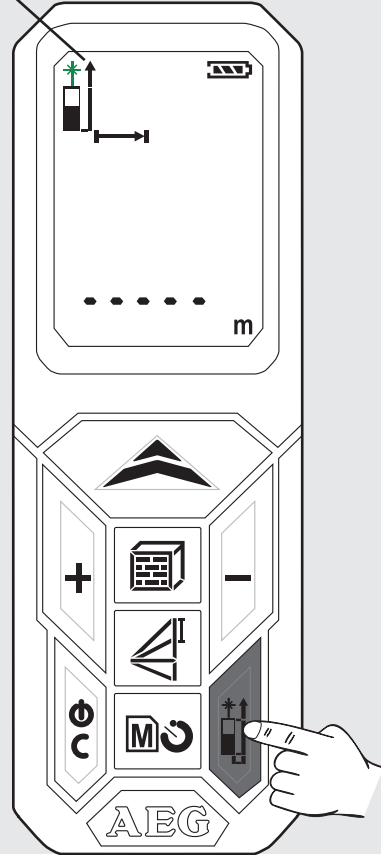
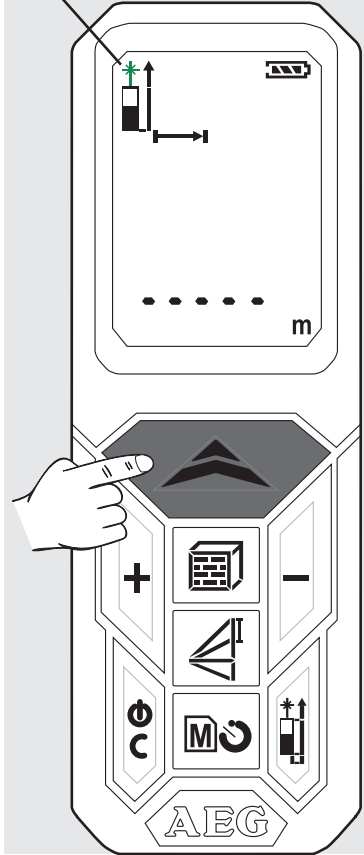

ALAN ÖLÇÜMÜ ÖRNEĞİ (2) İLE İLGİLİ TEMEL AÇIKLAMA

6 Kaydedilen değerleri görüntüle

M (bellek) düğmesine 2 sn basın.
+’ya basın veya -’ye basın

7 Bellekten çık

⏻ (güç) düğmesine bas.

8 Cihazı kapat

⏻ düğmesine 2 sn basın
(Önce bellekten çıkmış olmalısınız)

- Kaydedilmiş değerler, ana satırda gösterilir.

- İlişkili simge ekranda belirir ve ölçülen parametre yanıp söner (yanıp sönen yeşil ışıkla gösterilir)

- Cihaz kapanır.

- Hiçbir düğmeye basılmazsa, cihaz 3 dakika sonra kendiliğinden kapanır.

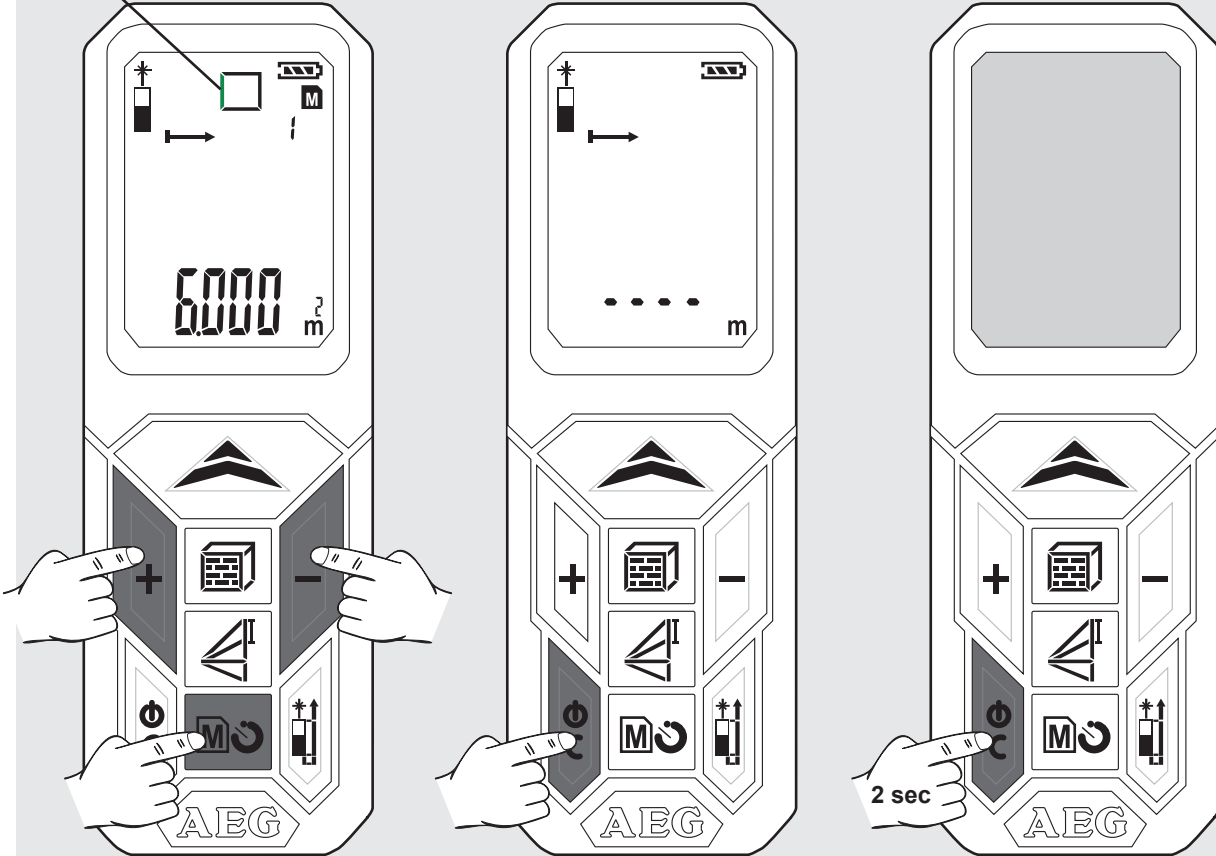

TECHNICKÁ DATA

Třída ochrany	IP54 (chráněný proti prachu a stříkající vodě)
Optika	14 mm
Ohnisko	35 mm
Max. měřený rozsah	50 metrů (tolerance: 55 m)
Min. měřený rozsah	0,05 metru
Absolutní přesnost @ < 10m	± 1,5 mm (Max)
Opakovaná přesnost @ < 10m	± 1,5 mm (typicky max. 2σ)
Opakovaná přesnost @ > 10m	vzestup ± 0,25 mm / metr (typicky max. 2σ)
Doba měření	0,5 s
Typ displeje	LCD (22,7 mm x 31 mm)
Napájení	AAA 2x (alkalické baterie)
Životnost baterií	10000 (jednotlivých měření)
Výstupní výkon laseru	0,6 mW ~ 0,95 mW (třída 2, 650 nm)
Velikost laserového bodu	25 x 30 mm @ 16 m (Max)
Laserový paprsek vertikální úhel	+1 stupeň
Laserový paprsek horizontální úhel	±1 stupeň
Automatické vypnutí přístroje	180 sekund
Automatické vypnutí laseru	30 sekund
Rozsah provozní teploty	-10°C do +50°C
Rozsah teploty na uskladnění přístroje	-25°C do +70°C
Hmotnost bez baterií	80 g

OBLAST VYUŽITÍ

Laserový měřicí přístroj je vhodný na měření vzdáleností a sklonů.

Toto zařízení lze používat jen pro uvedený účel.

TABULKA CHYBOVÝCH KÓDŮ

Kód	Popis	Řešení
Err01	Mimo měřený rozsah	Měření proveďte ve stanoveném rozsahu.
Err02	Odražený signál je příliš slabý	Vyberte si lepší povrch.
Err03	Mimo interval zobrazování (max. hodnota: 99.999) např. když je výsledek plochy nebo objemu mimo interval zobrazování	Zkontrolujte, jestli jsou hodnoty a kroky správně.
Err04	Chyba ve výpočtu podle Pythagorovy věty	Zkontrolujte, jestli jsou hodnoty a kroky správně.
Err05	Slabé baterie	Vložte nové baterie.
Err06	Mimo rozsah provozní teploty	Měření zrealizujte ve stanoveném rozsahu provozní teploty.
Err07	Příliš jasné světlo okolního prostředí	Cílovou zónu zatemněte.

Funkce Pythagoras
převýšení

úroveň měření

měření délky

minimum / maximum pro kontinuální měření

sčítání / odčítání

ZAP / MĚŘIT

- ▶ Zap
- ▶ Měřit
- ▶ Kontinuální měření (stisknout 2 sek)
- ▶ Min. / Max. funkce

SČÍTÁNÍ

- ▶ Sčítat hodnotu
- ▶ Navigovat v paměti

PLOCHA / OBJEM

- ▶ Plocha (stisknout 1x)
- ▶ Objem (stisknout 2x)
- ▶ Nepřímé měření plochy (stisknout 3x / 4x)

ZAPNUTÍ

- ▶ Zap
- ▶ Vyp (stisknout 2 sek)
- ▶ Vrátit do původního stavu

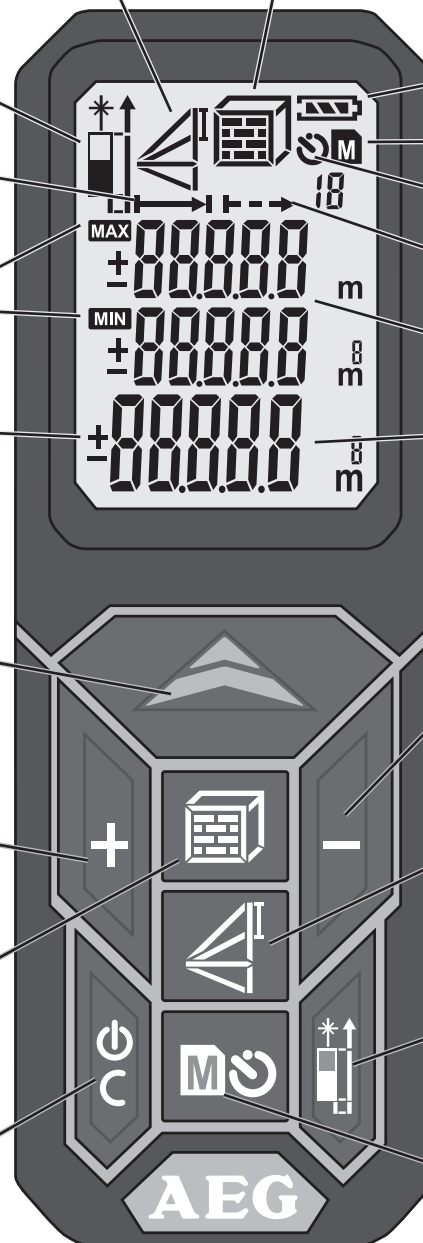

plocha / objem
nepřímé měření plochy

stav baterií

paměť

časovač

kontinuální měření

mezihodnoty

celková hodnota

ODČÍTÁNÍ

- ▶ Odčítat hodnotu
- ▶ Navigovat v paměti

FUNKCE PYTHAGORAS

- ▶ Funkce Pythagoras 1 (stisknout 1x)
- ▶ Funkce Pythagoras 2 (stisknout 2x)
- ▶ Funkce Pythagoras 3 (stisknout 3x)

ZMĚNA ÚROVNĚ MĚŘENÍ

- ▶ od přední části
- ▶ od zadní části
- ▶ od rohového kolíku

PAMĚŤ

- ▶ Časovač 3-15 sek (stisknout 1x)
- ▶ Paměť 1-20 (stisknout 1x 2 sek)
- ▶ Pomocí tlačítek +/- navigujte v paměti

VÝMĚNA BATERIÍ

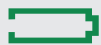
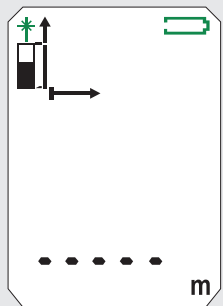

Když bliká symbol,
je třeba vyměnit
baterie.

1

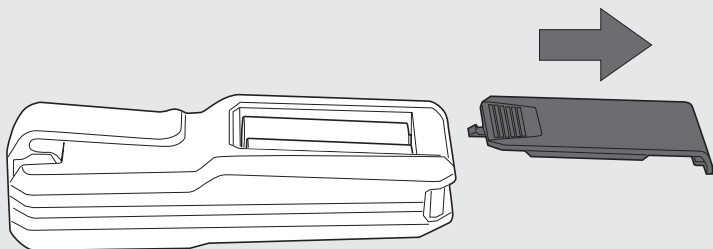

2

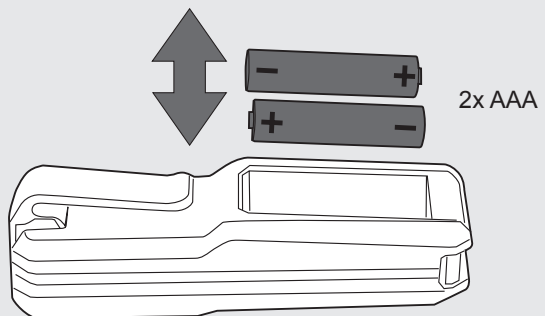

3

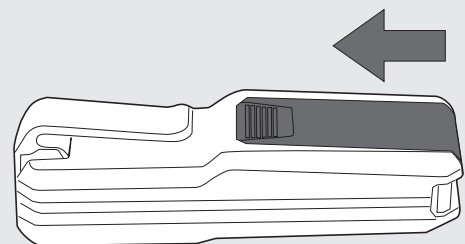

ROHOVÝ KOLÍK

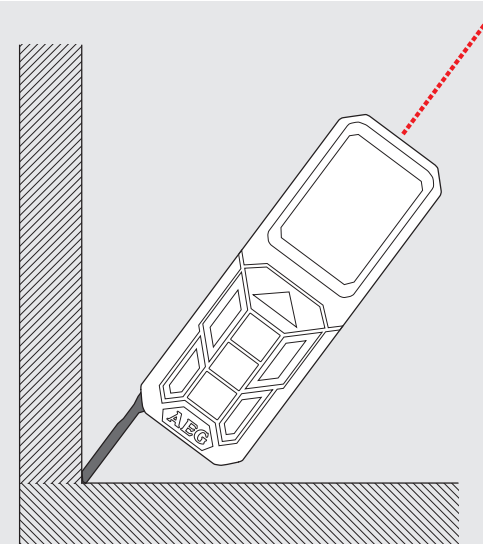
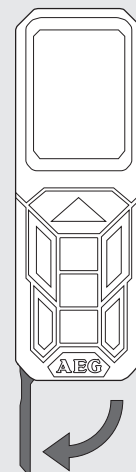

DRŽÁK NA OPASEK

1

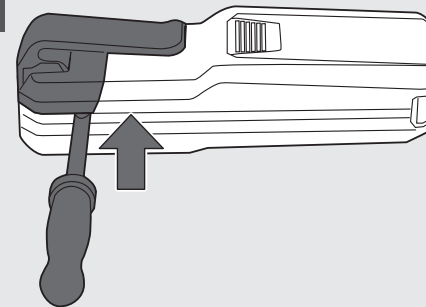

2

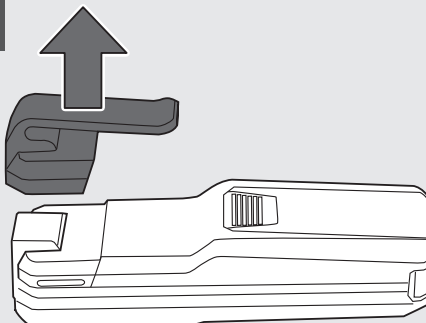

3

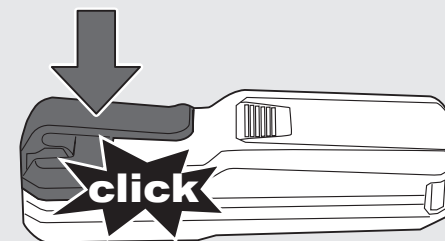

FUNKČNÍ TLACÍTKO, FUNKCE PYTHAGORAS, ÚROVEŇ MĚŘENÍ

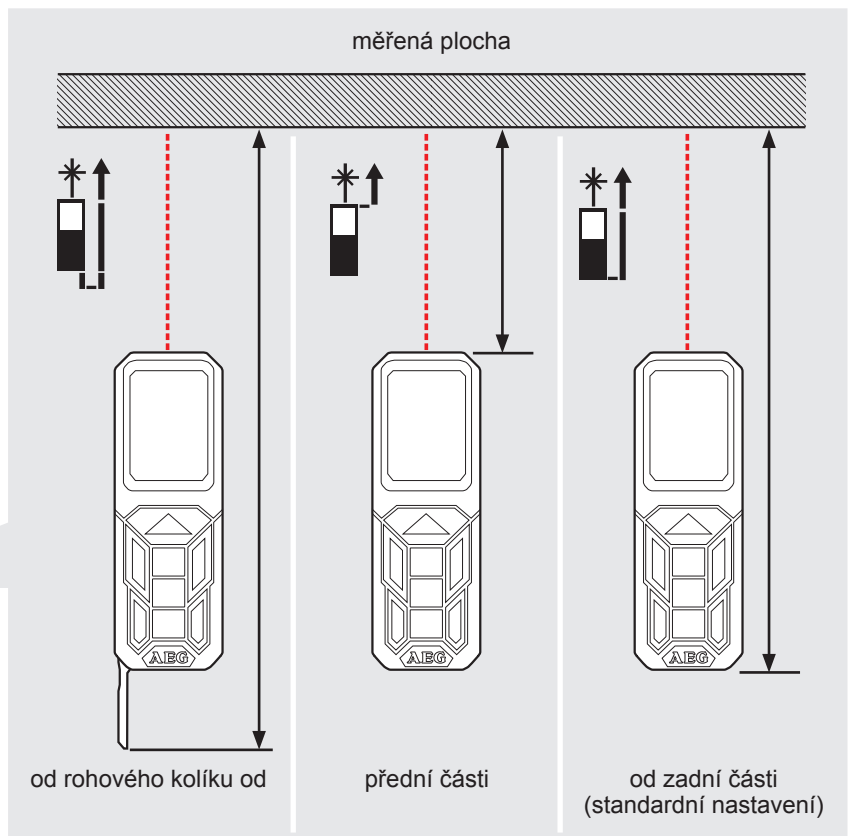
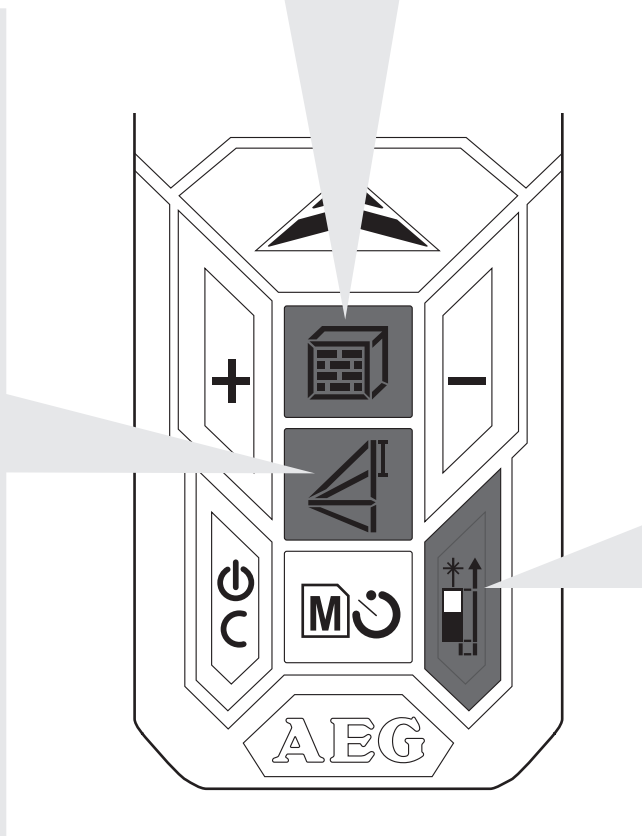
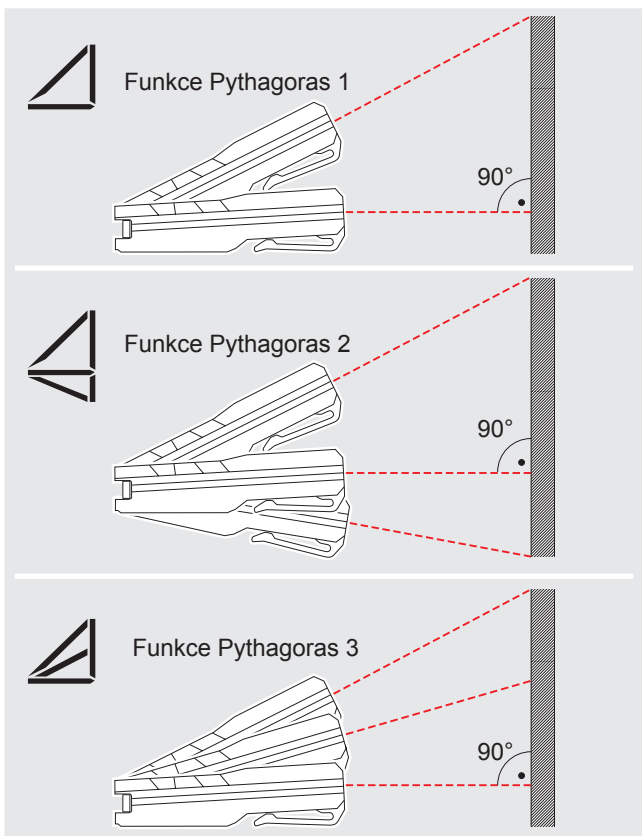
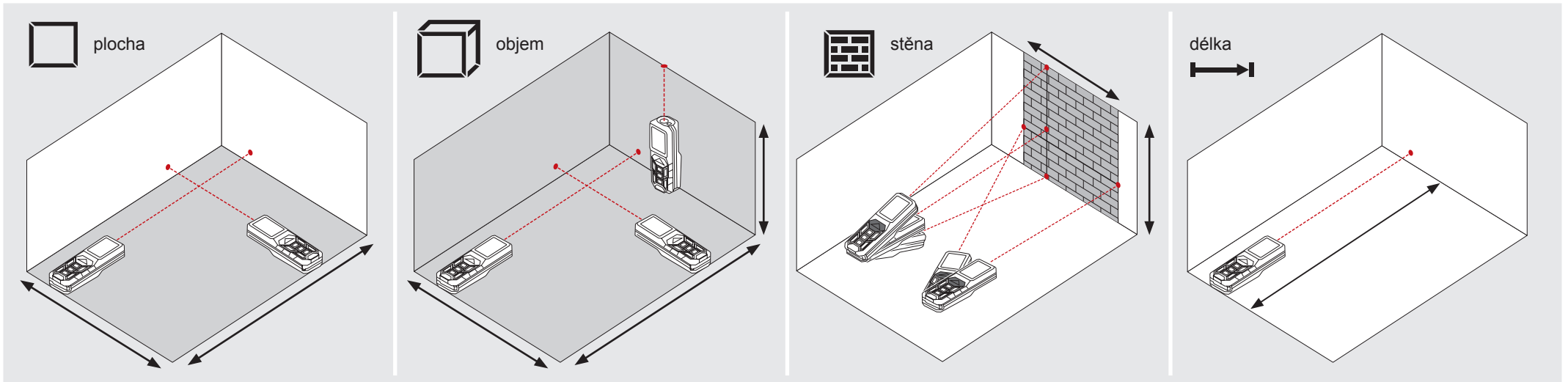

JEDNODUCHÉ MĚŘENÍ DÉLKY

0

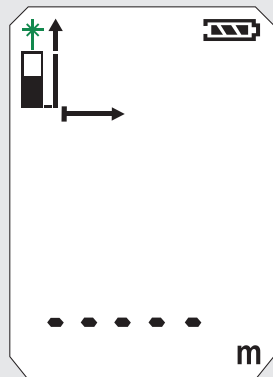

1

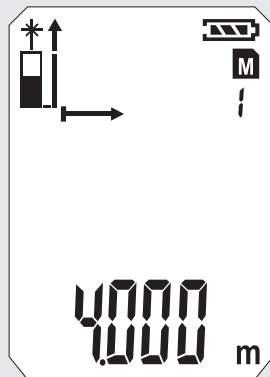
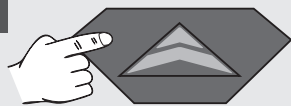

2

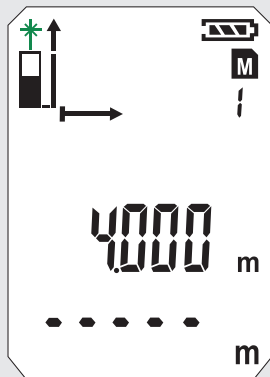
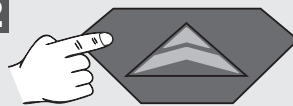

3

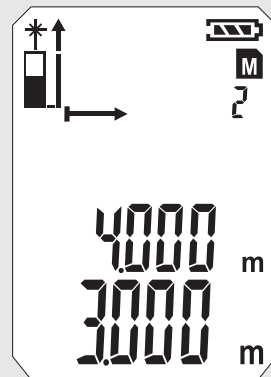
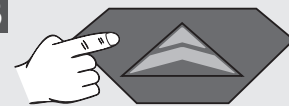

4

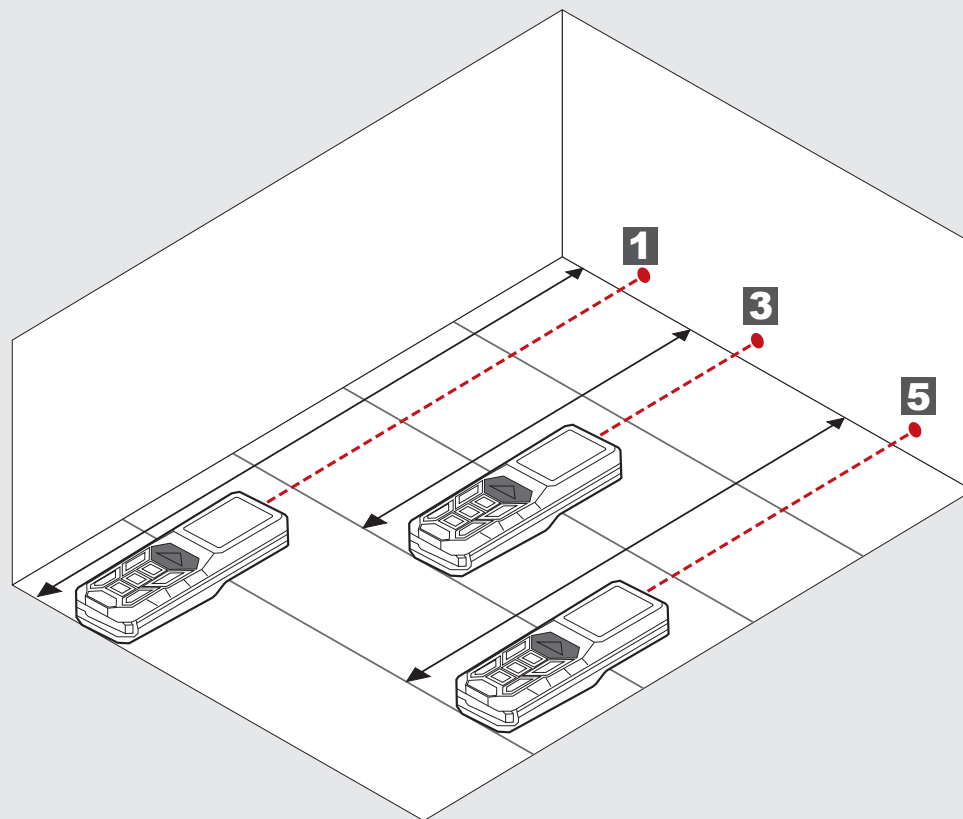
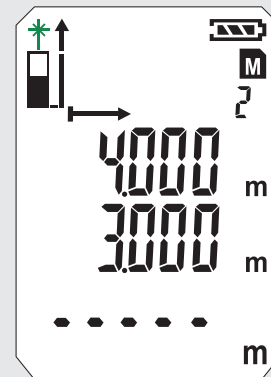
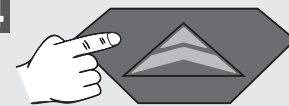

5

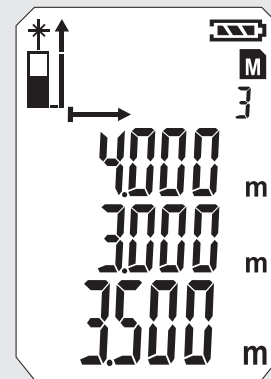
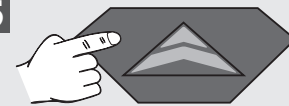

KONTINUALNÍ MĚŘENÍ / MĚŘENÍ MINIMA - MAXIMA

0

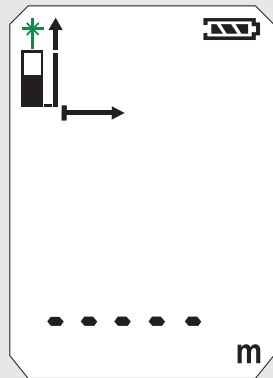

1

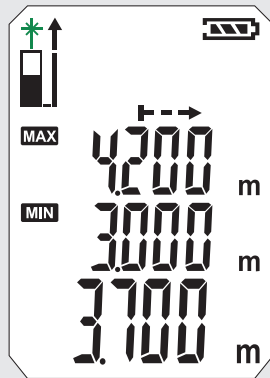
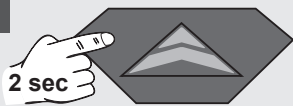

2

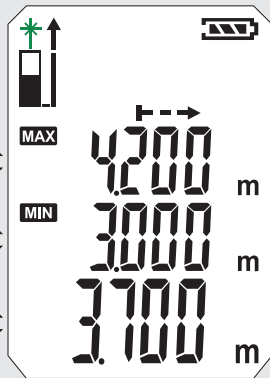

3

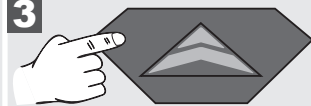

Stop
MIN / MAX

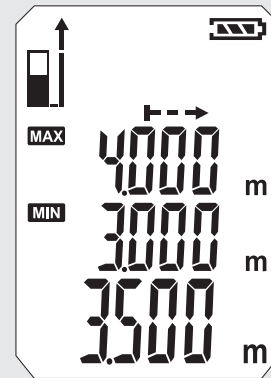

4

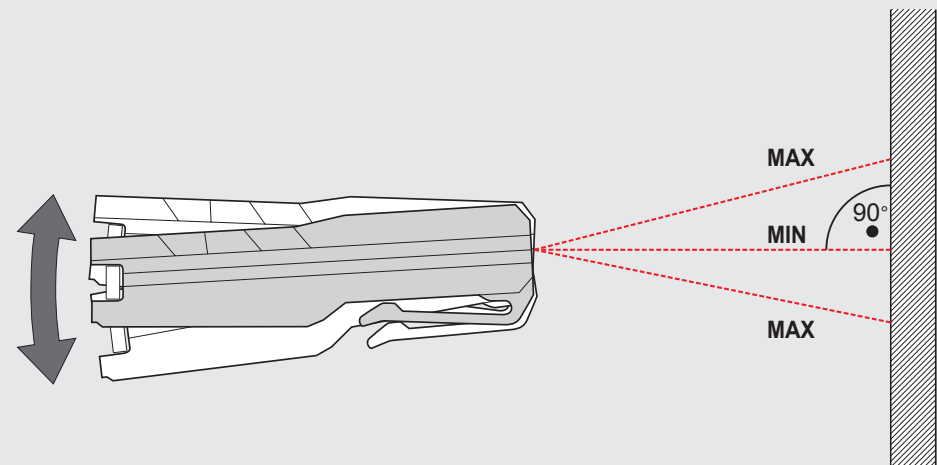
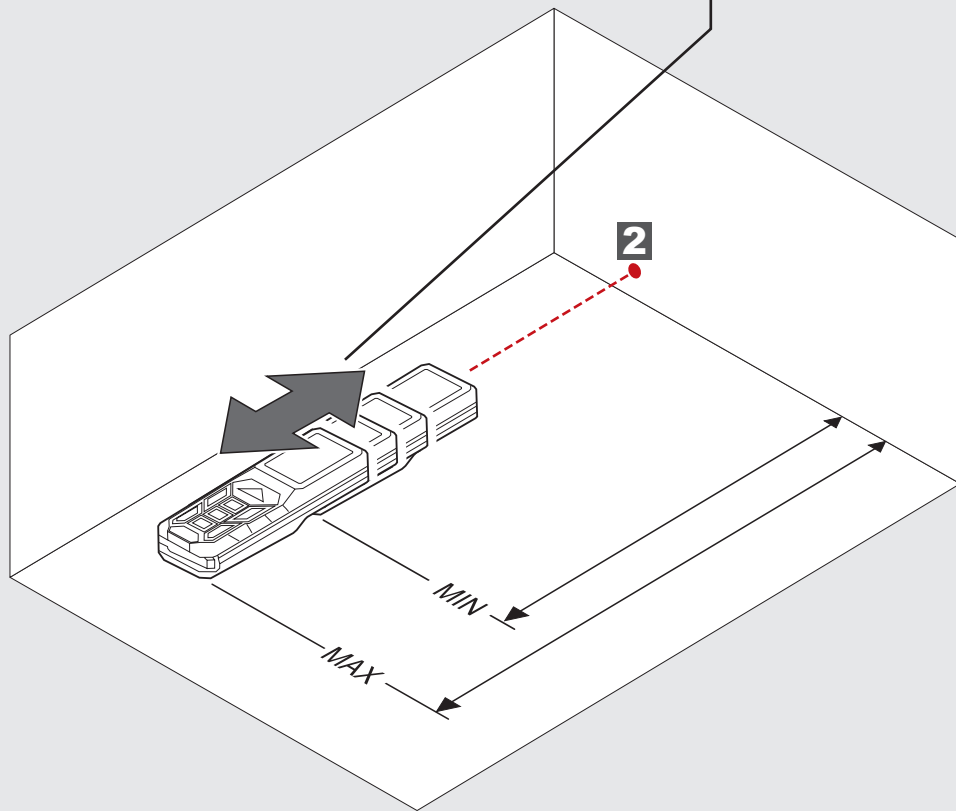
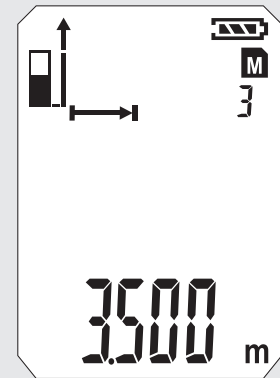

0

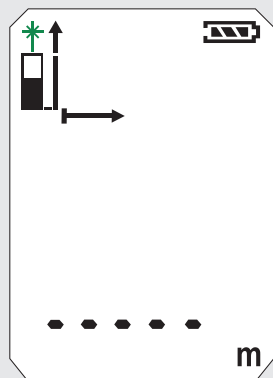

1

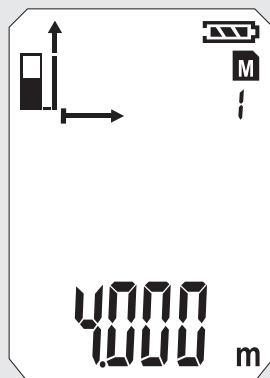
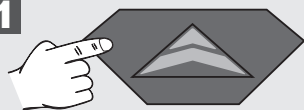

2

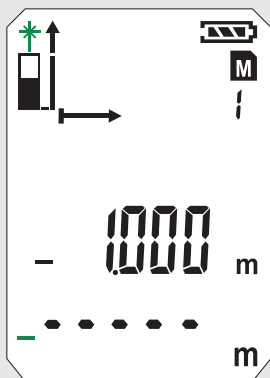

3

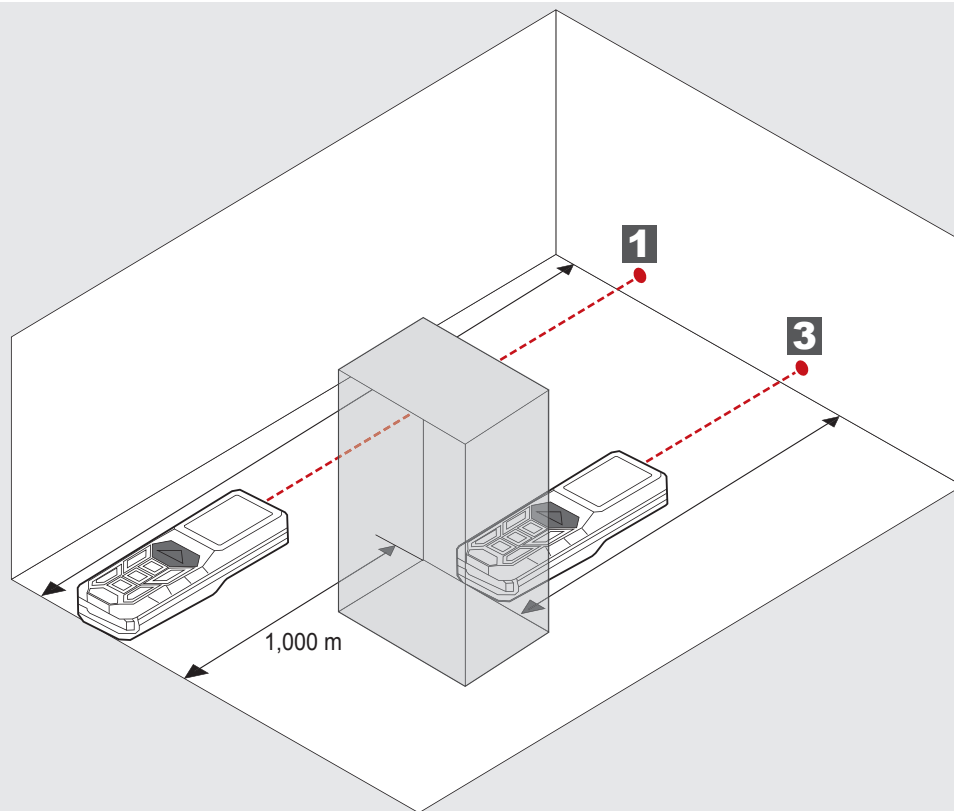
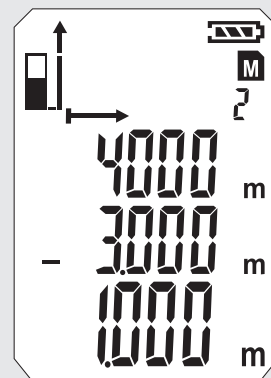
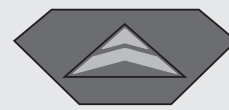

0



1

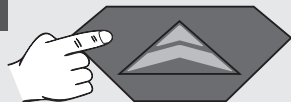

2

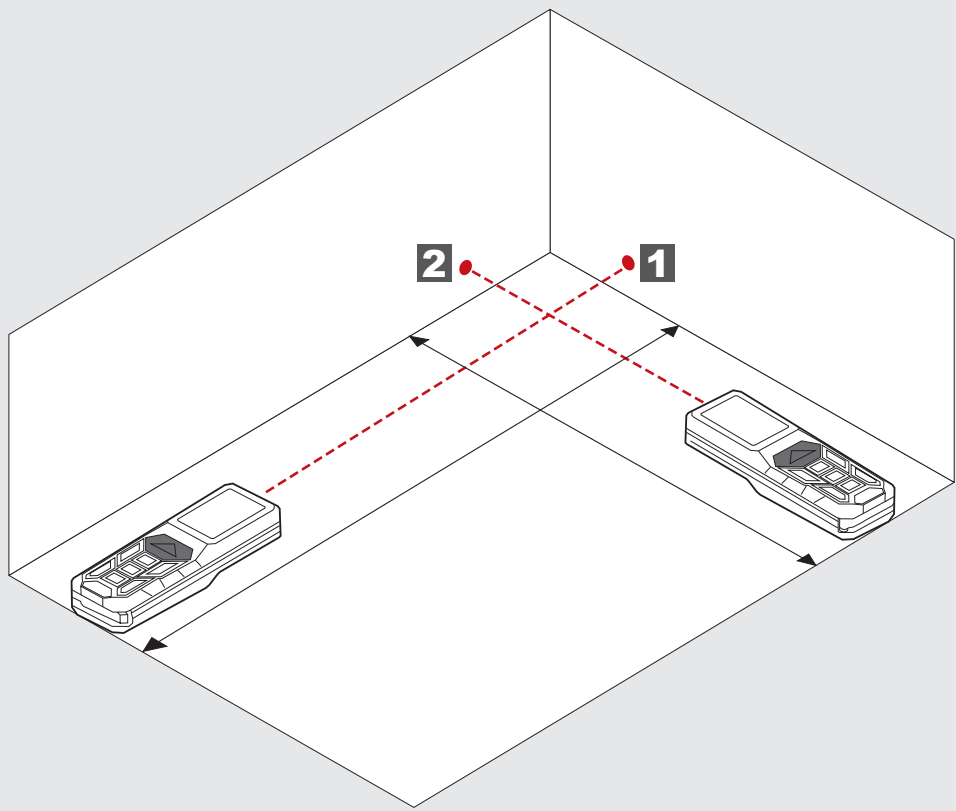
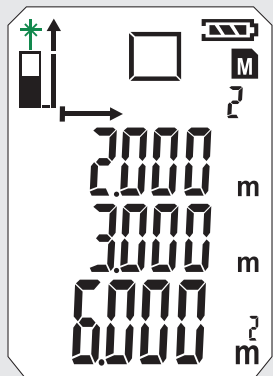
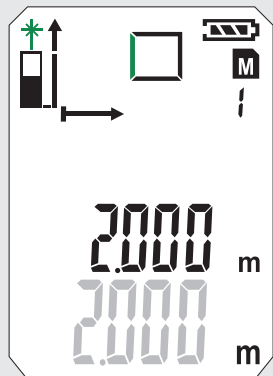
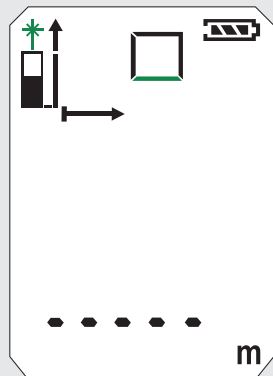
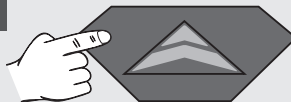

MĚŘENÍ OBJEMU

0



1

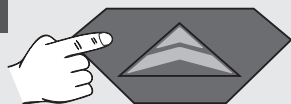

2

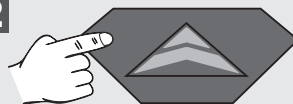

3

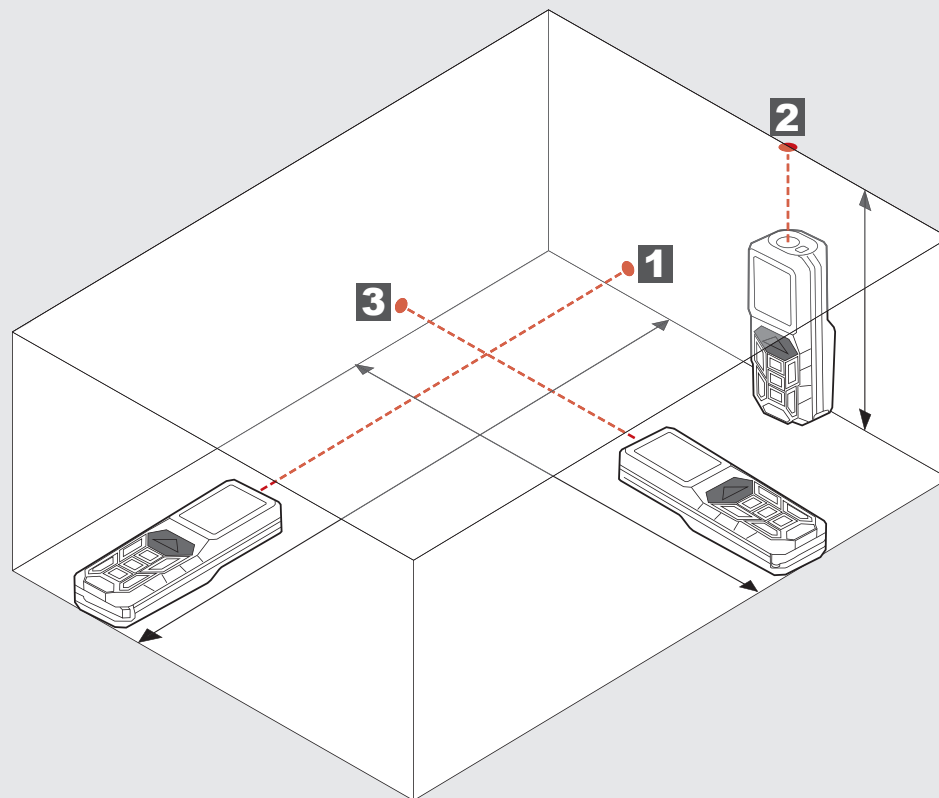
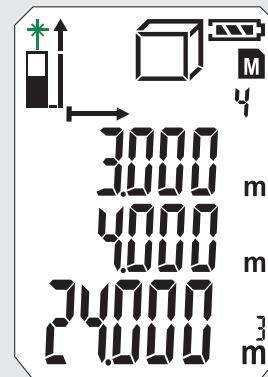
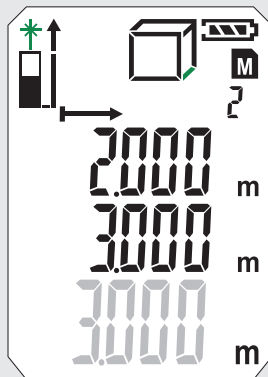
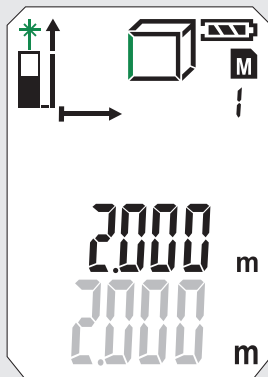
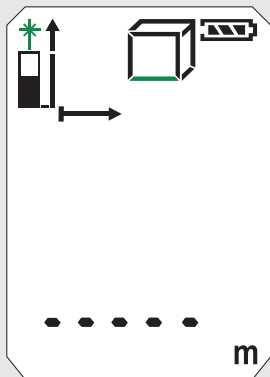
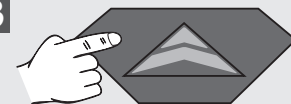

NEPRÍMÉ MĚŘENÍ (FUNKCE PYTHAGORAS 1)

0



1

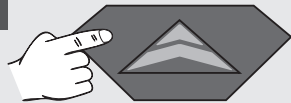

2

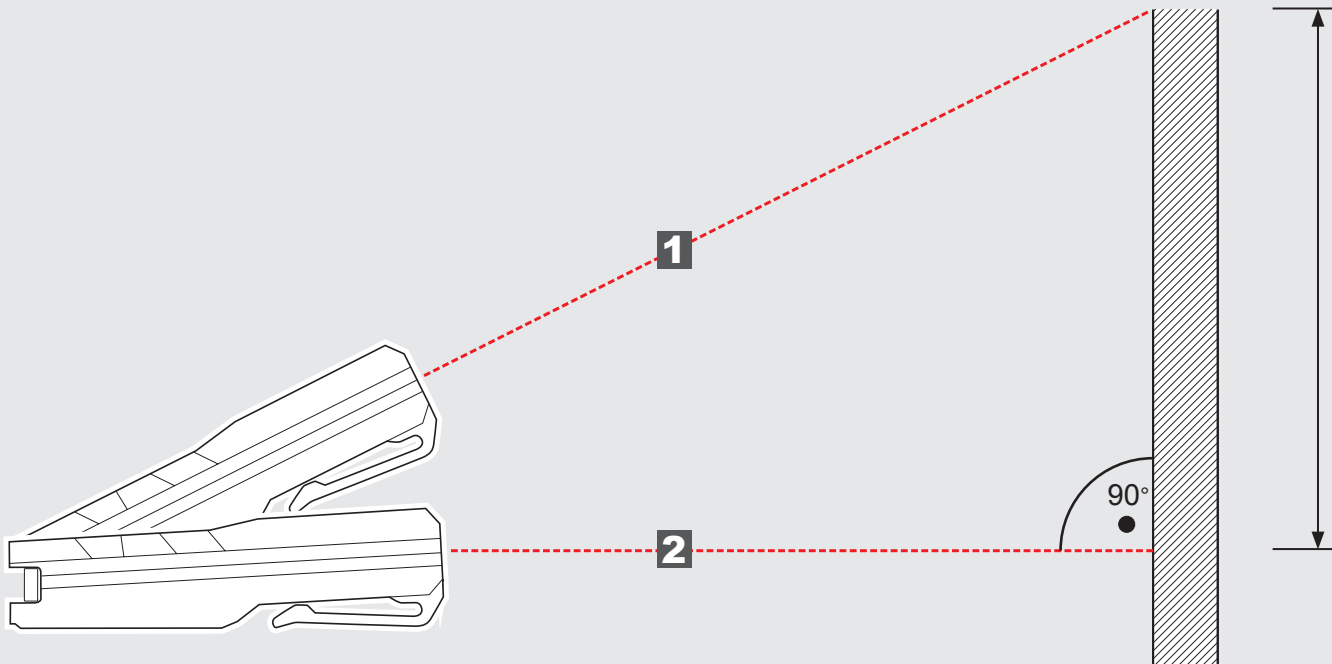
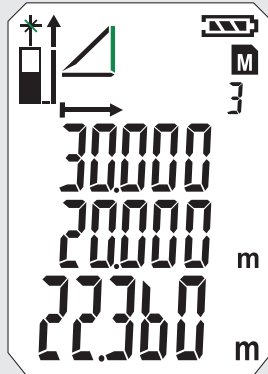
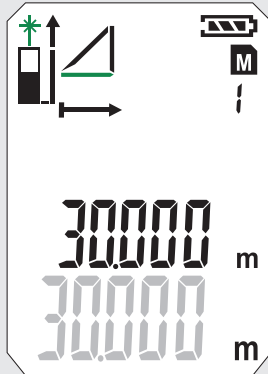
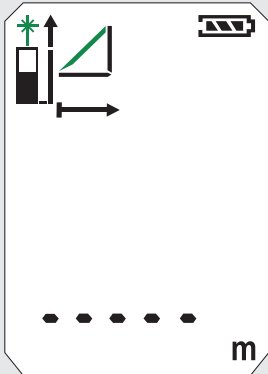
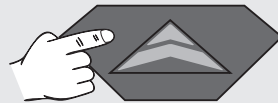

NEPRÍMÉ MĚŘENÍ (FUNKCE PYTHAGORAS 2)

0



1

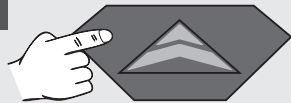

2

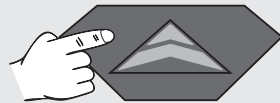

3

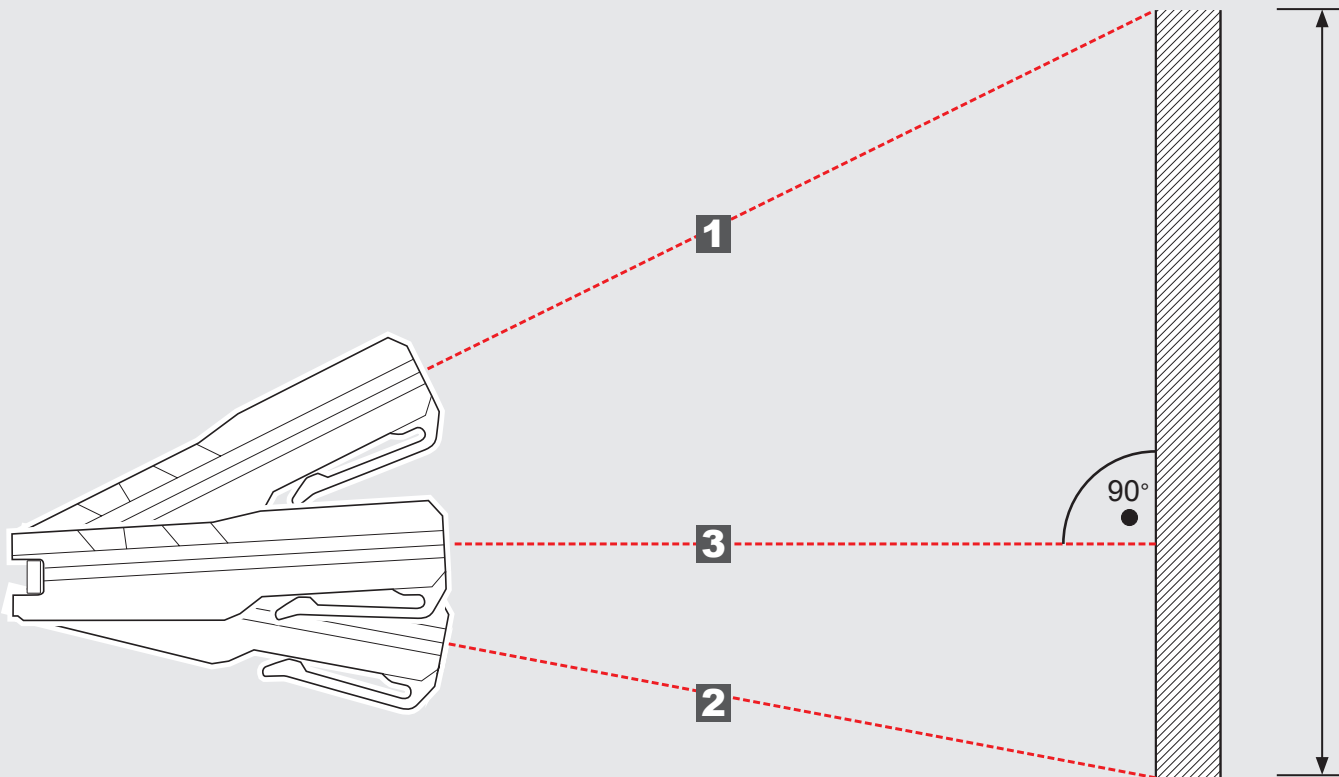
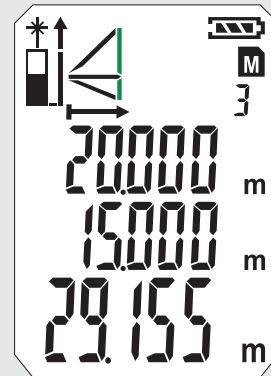
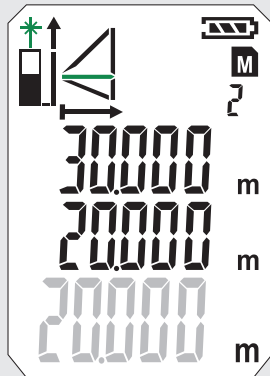
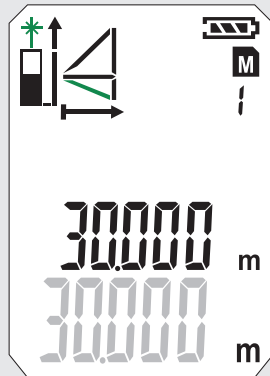
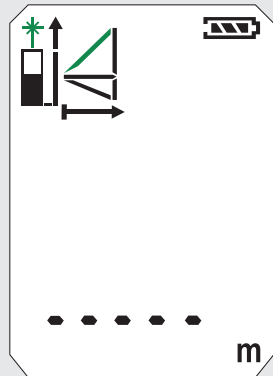
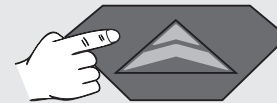

NEPRÍME MĚŘENÍ (FUNKCE PYTHAGORAS 3)

1



2

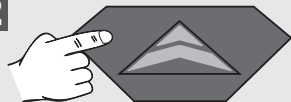

3



4

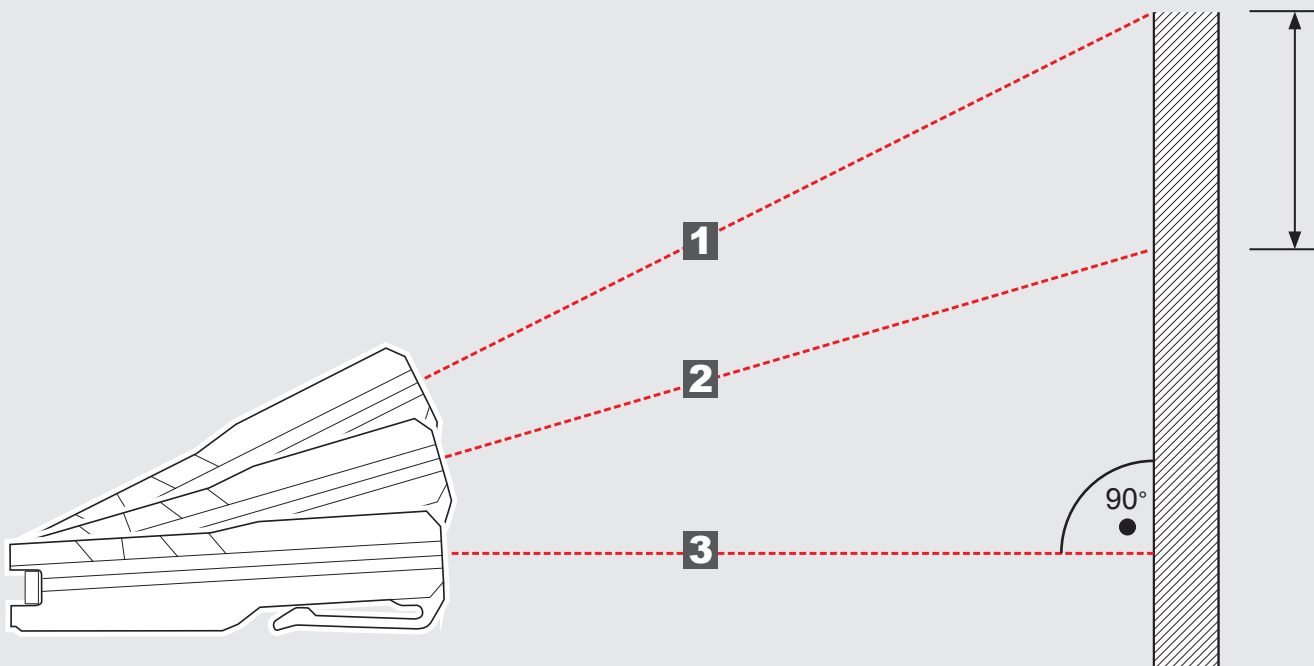
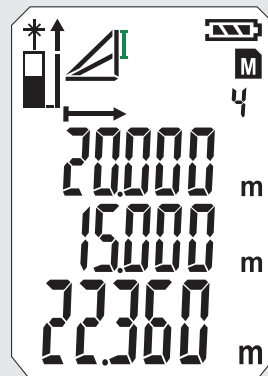
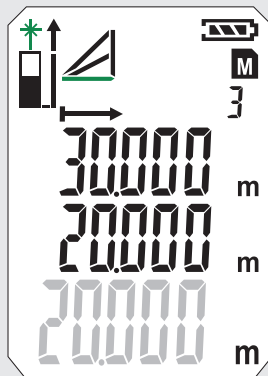
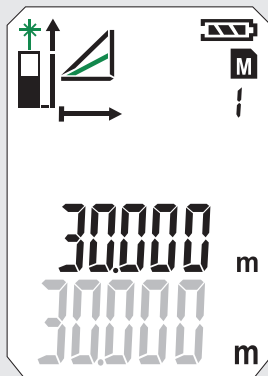
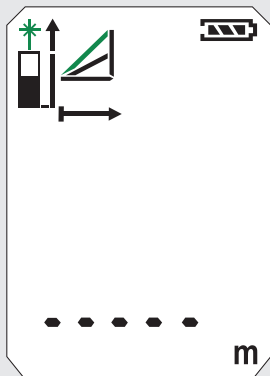





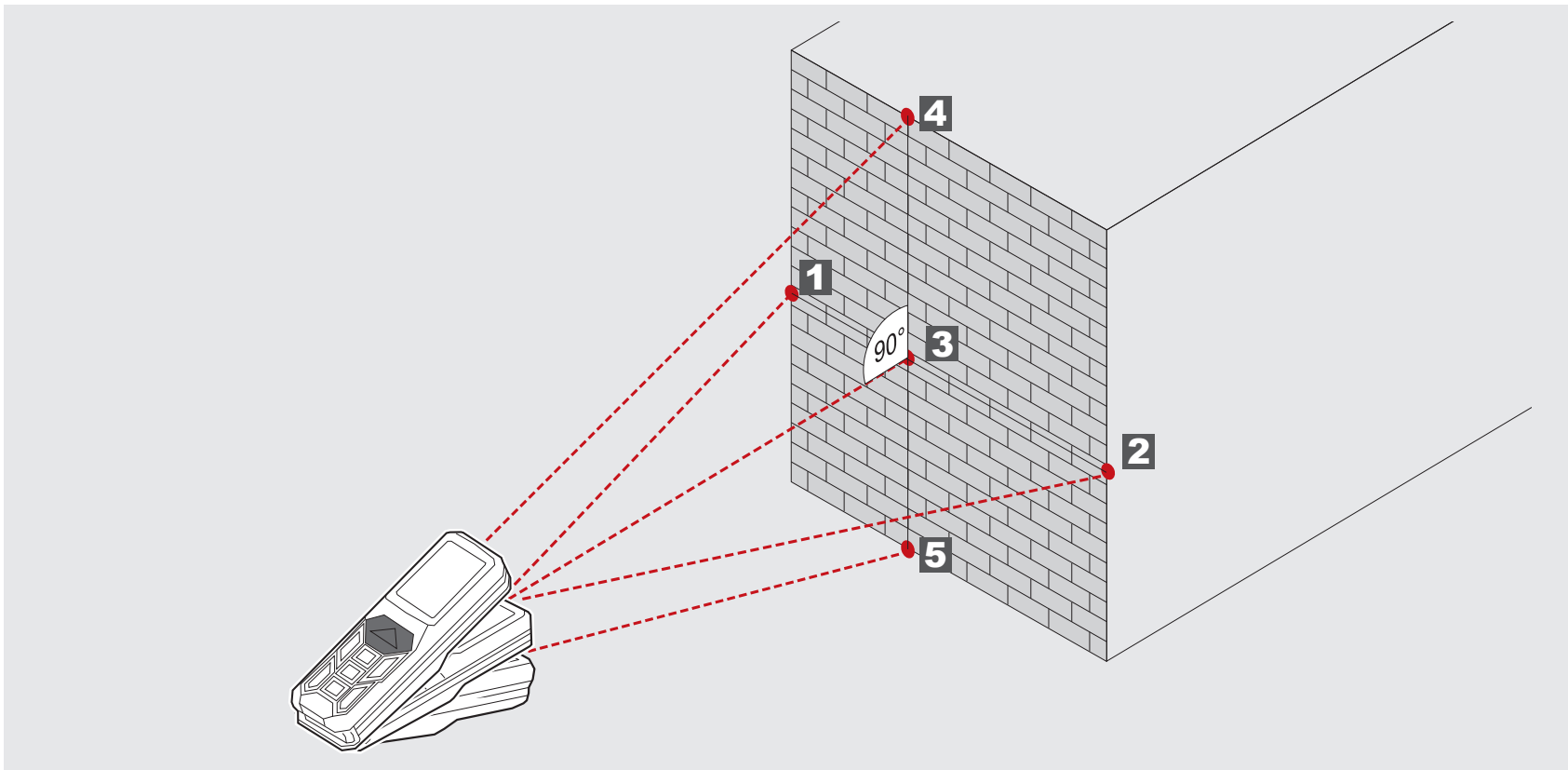





MĚŘENÍ PLOCHY STĚNY (SCÉNÁŘ 1)

0 	1 	2 	3 	4



5

MĚŘENÍ PLOCHY STĚNY (SCÉNÁŘ 2)

0 	1 	2 	3 	4 
				

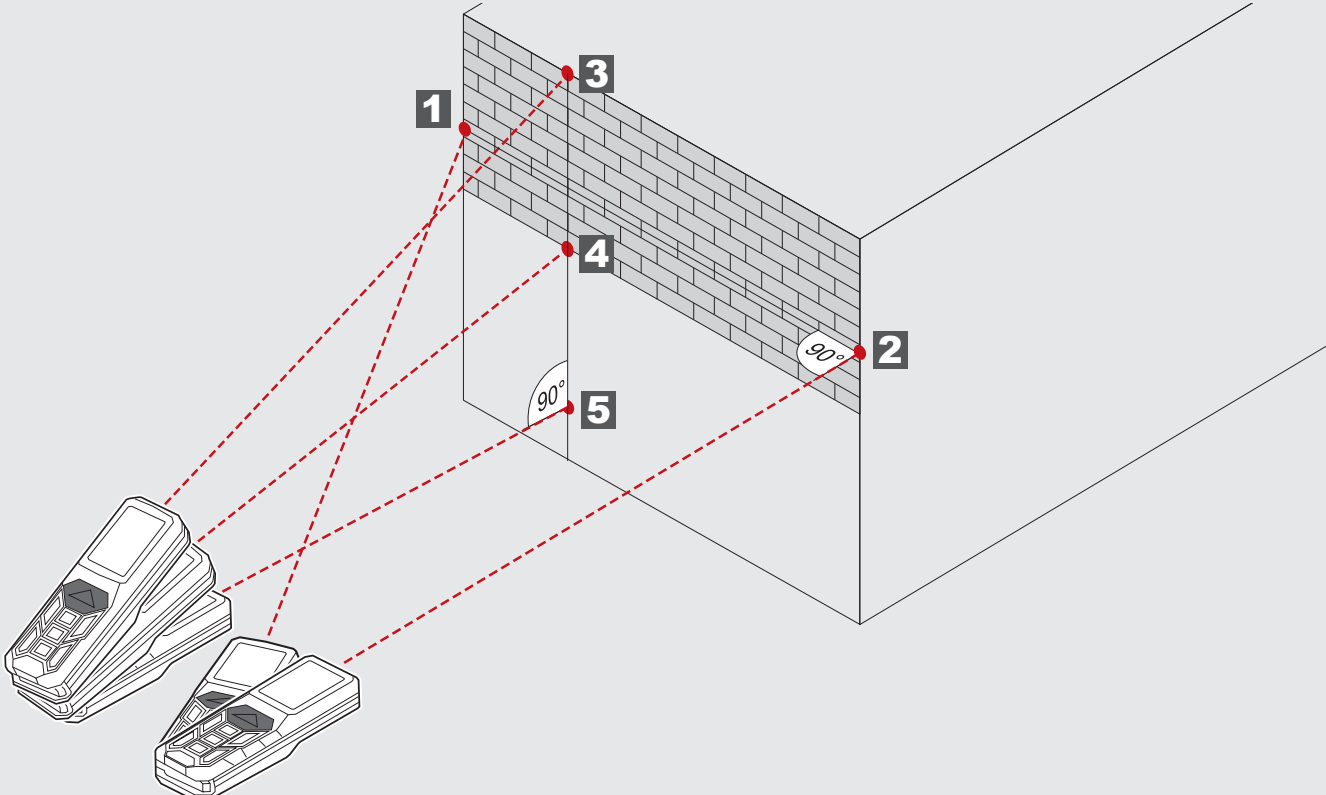

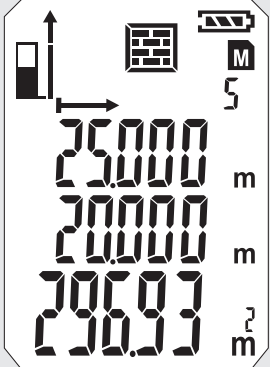

5





CASOVAC

Pomocí časovače se dá měření spustit s pozdějším startem, aby se např. na konstrukční díl mohl umístit měřený paprsek.

Stiskněte tlačítko 

- Objeví se symbol  se stisknutím tlačítka  se časovač dá nastavit v rozpětí od 3 do 15 sekund.

Stiskněte tlačítko 

- Sekundy se budou odpočítávat do měření. Při 0 se spustí měření.

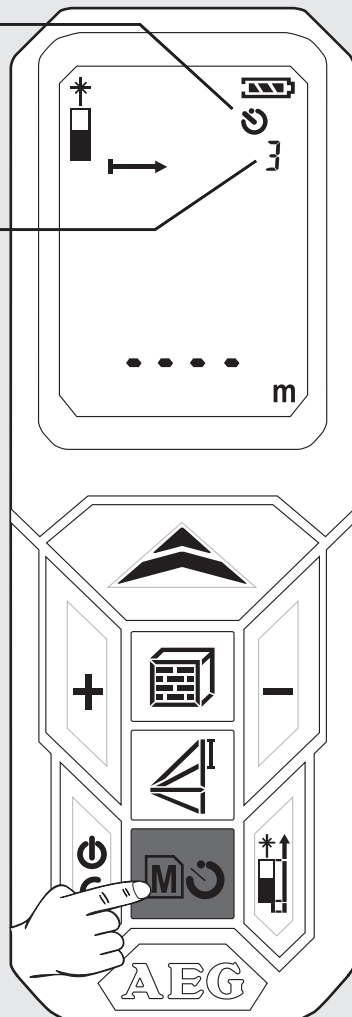

PAMĚŤ

Naměřené hodnoty se automaticky průběžně ukládají do paměti.

Hodnoty uložené v paměti je možné vyvolat tlačítkem  .

Stiskněte tlačítko  na 2 sekundy

- Objeví se symbol a místo v paměti.
- Zobrazí se příslušná měřená veličina.
- V paměti uložená hodnota se zobrazí v hlavním řádku.
- Pomocí tlačítek +/- se naviguje

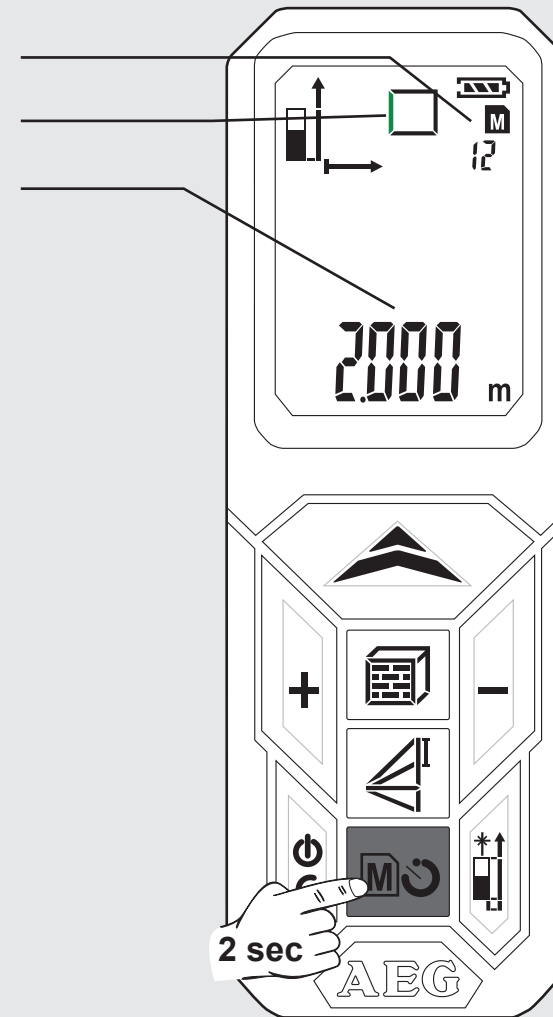



ZÁKLADNÍ ZPŮSOB FUNGOVÁNÍ NA PŘÍKLADU MĚŘENÍ PLOCHY (1)

1 Zapnutí

Stiskněte tlačítko .
⚠ Pozor! Laserový paprsek je zapnutý!
 Nemířte jím na osoby!

2 Výběr úrovně měření

Po zapnutí standardní nastavení: měření od zadní části měřiče
 stisknout 1x -> od rohového kolíku
 stisknout 2x -> měření od přední části měřiče
 stisknout 3x -> měření od zadní části měřiče

3 Výběr funkce

Po zapnutí je přístroj vždy nastavený na měření délky.
 stisknout 1x - měření plochy

4 Měření délky

Přístroj vyrovnejte a stiskněte tlačítko 

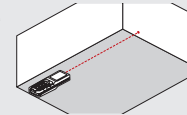

5 Měření šířky

Přístroj vyrovnejte a stiskněte tlačítko 

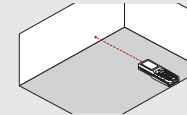

Bliká symbol laseru (blikání zobrazené zelenou barvou).

Zobrazí se symbol

- Objeví se symbol
 - Bliká měřená hodnota (blikání zobrazené zelenou barvou)

- Naměřená hodnota se krátce zobrazí v hlavním řádku.
 - Naměřená hodnota po 1 sekundě přeskočí do řádku ležícího výše.
 Naměřená hodnota se uloží do paměti pod pořadovým číslem.
 Bliká druhá měřená hodnota. Přístroj je připravený na měření druhé hodnoty.

- Naměřená hodnota se krátce zobrazí v hlavním řádku.
 - Naměřená hodnota po 1 sekundě přeskočí do řádku ležícího výše.
 Naměřená hodnota se uloží do paměti pod pořadovým číslem.
 - Výsledek se zobrazí v hlavním řádku a uloží se do paměti pod pořadovým číslem.

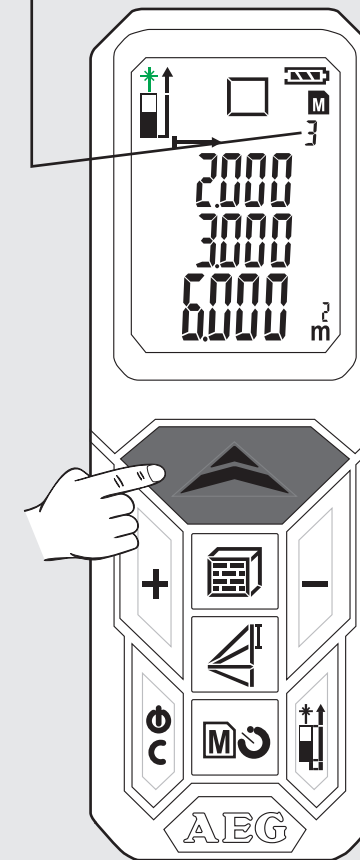
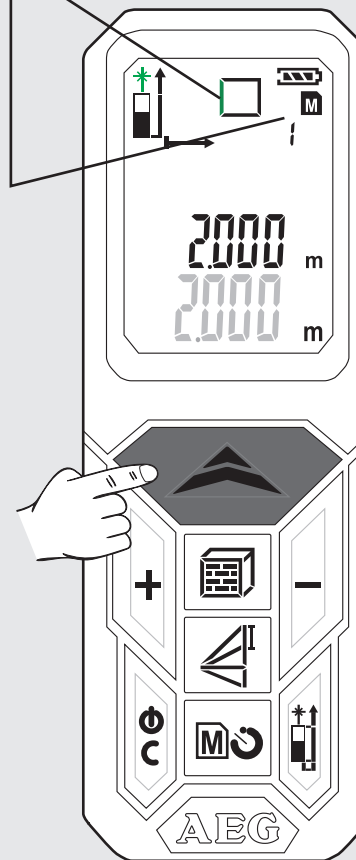
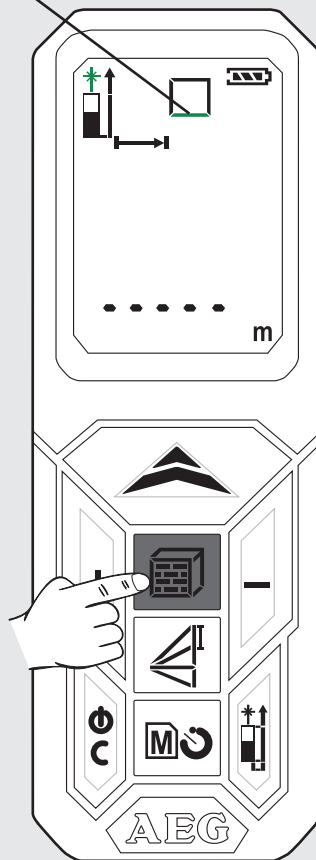
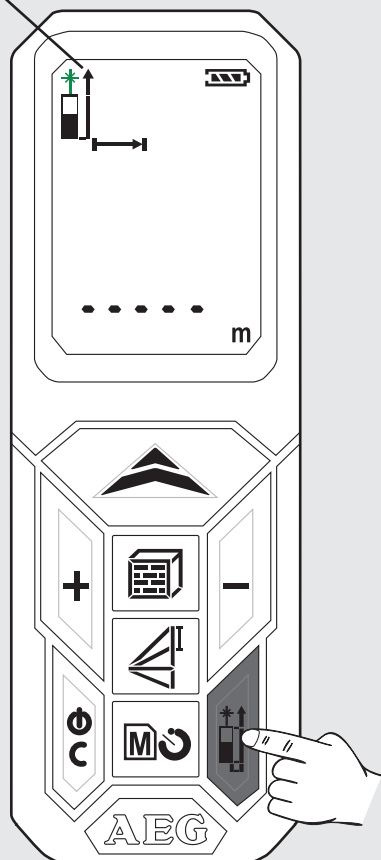
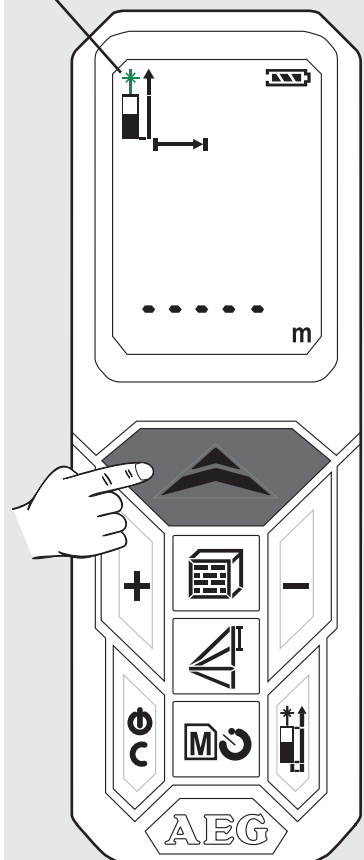

ZÁKLADNÍ ZPŮSOB FUNGOVÁNÍ NA PŘÍKLADU MĚRENÉ PLOCHY (2)

6 Vvolání hodnot uložených v paměti

Tlačítko  stiskněte na 2 sekundy.

Stiskněte tlačítko + nebo -

- Hodnoty uložené v paměti se zobrazí v hlavním řádku.

- Zobrazí se příslušný symbol a bliká měřená hodnota (blikání zobrazené zelenou barvou).

7 Opuštění paměti

Stiskněte tlačítko 

8 Vypnutí

Tlačítko  stiskněte na 2 sekundy (Předtím se musí odejít z paměti).

- Přístroj se vypne.

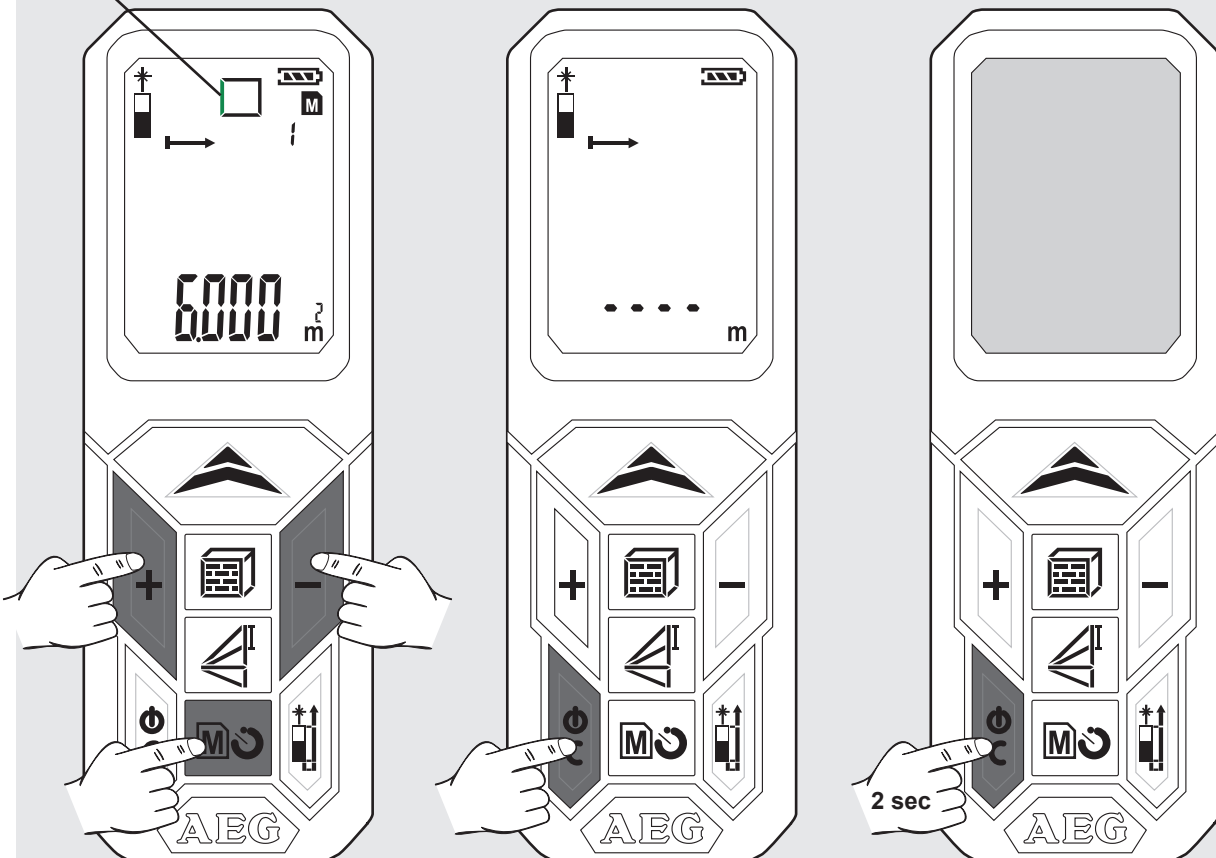

- Pokud se v průběhu 3 minut nestiskne žádné tlačítko, přístroj se vypne automaticky.



OBSAH

Dôležité bezpečnostné pokyny.....1
 Technické údaje.....2
 Použitie podľa predpisov2
 Tabuľka chybových kódov2
 Prehľad.....3
 Výmena batérií4
 Rohový kolík.....4
 Držiak na opasok.....4
 Funkčné tlačidlo, Funkcia Pytagoras, Úroveň merania5
 Jednoduché meranie dĺžky.....6
 Kontinuálne meranie / meranie minima - maxima7
 Meranie pripočítaním / meranie odpočítaním8
 Meranie plochy9
 Meranie objemu.....10
 Nepriame meranie (funkcia Pytagoras 1).....11
 Nepriame meranie (funkcia Pytagoras 2).....12
 Nepriame meranie (funkcia Pytagoras 3).....13
 Meranie plochy steny (scenár 1)14
 Meranie plochy steny (scenár 2)15
 Časovač.....16
 Pamäť.....16
 Základný spôsob fungovania na príklade merania plochy (1).....17
 Základný spôsob fungovania na príklade merania plochy (2).....18

DÔLEŽITÉ BEZPEČNOSTNÉ POKYNY

  Výrobok používajte až po preštudovaní bezpečnostných pokynov a návodu na používanie na priloženom CD.

Klasifikácia lasera

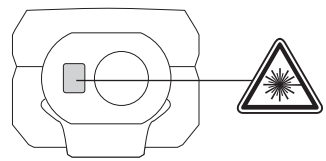

VÝSTRAHA:
 Toto zariadenie je laserový výrobok **triedy 2** v súlade s normou IEC 60825-1:2007.



Etiketa

Pred prvým uvedením do prevádzky prelepte anglický text na výkonovom štítku samolepkou so slovenským textom, ktorá je súčasťou dodávky.

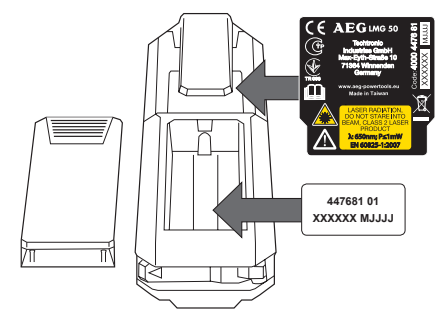

Výstraha:
 Vyhnite sa priamemu kontaktu s očami. Laserový lúč môže poškodiť oči zábleskom a viesť ku krátkemu oslepeniu.

Nepozerajte do laserového lúča ani ho zbytočne nemierte na iných ľudí.

Neoslepujte iné osoby.

Výstraha:
 Laserový prístroj neprevádzkujte v blízkosti detí a deťom nedovoľte, aby laserový prístroj používali.

Pozor! Reflexný povrch by mohol laserový lúč odraziť späť na obsluhu alebo iné osoby.

Okraje udržujte v bezpečnej vzdialenosti od pohyblivých častí.

Pravidelne vykonávajte skúšobné merania. Obzvlášť pred, počas a po dôležitých meraniach.

Dávajte pozor na chybné merania, ak je výrobok poškodený, ak spadol, bol nesprávne používaný alebo upravený.

Dôležité upozornenie! Dobre sa oboznámte s obslužnými prvkami a so správnym používaním tohto záhradníckeho náradia.

Laserový merací prístroj má obmedzenú oblasť použitia. (Pozri odsek "Technické údaje"). Pokusy merať mimo maximálneho a minimálneho rozsahu spôsobia nepresnosti. Jeho použitie za nepriaznivých podmienok, ako je príliš vysoká a príliš nízka teplota, veľmi ostré snečné svetlo, dážď, sneh, hmla alebo iné podmienky obmedzujúce viditeľnosť, môže viesť k nepresným meraniam.

Ak bude prístroj prenesený z teplého prostredia do studeného prostredia (alebo naopak), tak musíte počkať, kým sa prístroj prispôbi novj teplote okolitého prostredia.

Laserový merací prístroj vždy uskladňujte v miestnosti, prístroj chráňte pred otrasmí, vibráciami alebo extrémnymi teplotami.

Laserový merací prístroj chráňte pred prachom, mokrým prostredím a vysokou vzdušnou vlhkosťou. Tieto vplyvy môžu zničiť vnútorné súčiastky alebo ovplyvniť presnosť merania.

Nepoužívajte žiadne agresívne čistiace prostriedky alebo rozpúšťadlá. Čistite len čistou mäkkou handričkou.

Vyhňte sa silným úderom na prístroj alebo pádu laserového meracieho prístroja. Presnosť prístroja by mala byť preverená vtedy, ak prístroj spadol alebo bol vystavený inému mechanickému zaťaženiu.

Potrebné opravy na tomto laserovom prístroji smie realizovať len autorizovaný odborný personál.

Nepracujte s výrobkom vo výbušných nebezpečných oblastiach ani v agresívnych prostrediach.

Na nabíjanie batérií používajte iba nabíjačku, ktorú vám odporučil výrobca.

 Vybité batérie sa nesmú likvidovať s domovým odpadom. Dbajte o životné prostredie a odneste ich na zberné miesta, ktoré sú vybavené v súlade s vnútroštátnymi a miestnymi predpismi. Výrobok sa nesmie likvidovať s domovým odpadom. Výrobok likvidujte náležite v súlade s vnútroštátnymi predpismi vo svojej krajine. Dodržiavajte národné a lokálne predpisy. Kvôli získaniu informácií o likvidácii sa obráťte na miestne úrady alebo na vášho predajcu.



TECHNICKÉ ÚDAJE

Trieda ochrany	IP54 (chránený proti prachu a striekajúcej vode)
Optika	14 mm
Ohnisko	35 mm
Max. meraný rozsah	50 metrov (tolerancia: 55 m)
Min. meraný rozsah	0,05 metra
Absolútna presnosť @ < 10m	± 1,5 mm (Max)
Opakovaná presnosť @ < 10m	± 1,5 mm (typicky max. 2σ)
Opakovaná presnosť @ > 10m	vzostup ± 0,25 mm / meter (typicky max. 2σ)
Doba merania	0,5 s
Typ displeja	LCD (22,7 mm x 31 mm)
Napájanie	AAA 2x (alkalické batérie)
Životnosť batérií	10000 (jednotlivých meraní)
Výstupný výkon lasera	0,6 mW ~ 0,95 mW (trieda 2, 650 nm)
Veľkosť laserového bodu	25 x 30 mm @ 16 m (Max)
Laserový lúč vertikálny uhol	+1 stupeň
Laserový lúč horizontálny uhol	±1 stupeň
Automatické vypnutie prístroja	180 sekúnd
Automatické vypnutie lasera	30 sekúnd
Rozsah prevádzkovej teploty	-10°C do +50°C
Rozsah teploty na uskladnenie prístroja	-25°C do +70°C
Hmotnosť bez batérií	80 g

POUŽITIE PODĽA PREDPISOV

Laserový merací prístroj je vhodný na meranie vzdialeností a spádov.

Tento prístroj sa smie používať len v súlade s uvedenými predpismi.

TABUĽKA CHYBOVÝCH KÓDOV

Kód	Popis	Riešenie
Err01	Mimo meraného rozsahu	Meranie uskutočnite v stanovenom rozsahu.
Err02	Odrazený signál je príliš slabý	Vyberte si lepší povrch.
Err03	Mimo intervalu zobrazovania (max. hodnota: 99.999) napr. ak je výsledok plochy alebo objemu je mimo intervalu zobrazovania	Skontrolujte, či sú hodnoty a kroky správne.
Err04	Chyba vo výpočte podľa Pytagorovej vety	Skontrolujte, či sú hodnoty a kroky správne.
Err05	Slabé batérie	Vložte nové batérie.
Err06	Mimo rozsahu prevádzkovej teploty	Meranie zrealizujte v stanovenom rozsahu prevádzkovej teploty.
Err07	Príliš jasné svetlo okolitého prostredia	Cieľovú zónu zatemnite.

Funkcia Pytagoras
prevýšenie

úroveň merania

meranie dĺžky

minimum / maximum pre kontinuálne meranie

sčítanie / odčítanie

plocha / objem
nepriame meranie plochy

stav batérií

pamäť

časovač

kontinuálne meranie

medzihodnoty

celková hodnota

ZAP / MERAŤ

- ▶ Zap
- ▶ Merať
- ▶ Kontinuálne meranie (tlačiť 2 sek)
Min. / Max. funkcia

SČÍTANIE

- ▶ Sčítať hodnotu
- ▶ Navigovať v pamäti

PLOCHA / OBJEM

- ▶ Plocha (stlačiť 1x)
- ▶ Objem (stlačiť 2x)
- ▶ Nepriame meranie plochy (stlačiť 3x / 4x)

ZAPNUTIE

- ▶ Zap
- ▶ Vyp (tlačiť 2 sek)
- ▶ Vrátiť do pôvodného stavu

ODČÍTANIE

- ▶ Odčítať hodnotu
- ▶ Navigovať v pamäti

FUNKCIA PYTAGORAS

- ▶ Funkcia Pytagoras 1 (stlačiť 1x)
- ▶ Funkcia Pytagoras 2 (stlačiť 2x)
- ▶ Funkcia Pytagoras 3 (stlačiť 3x)

ZMENA ÚROVNE MERANIA

- ▶ od prednej časti
- ▶ od zadnej časti
- ▶ od rohového kolíka

PAMÄŤ

- ▶ Časovač 3-15 sek (stlačiť 1x)
- ▶ Pamäť 1-20 (stlačiť 1x 2 sek)
- ▶ Pomocou tlačidiel +/- navigujte v pamäti

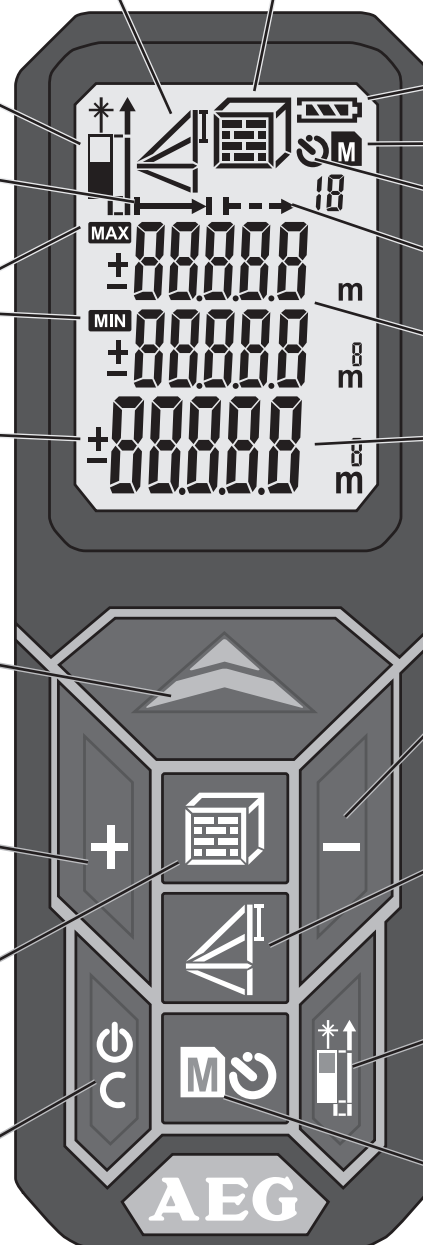

VÝMENA BATÉRIÍ

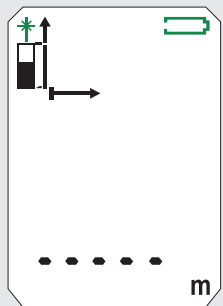

Keď bliká symbol, treba vymeniť batérie.

1

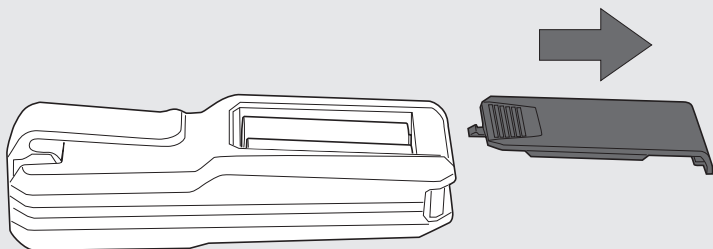

2

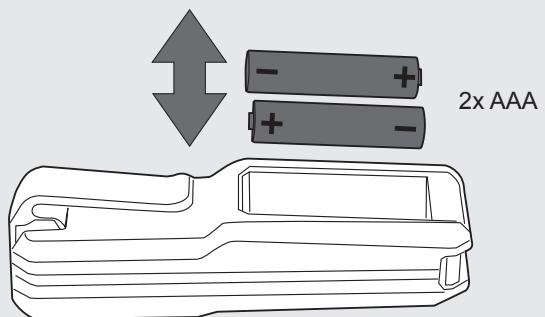

3

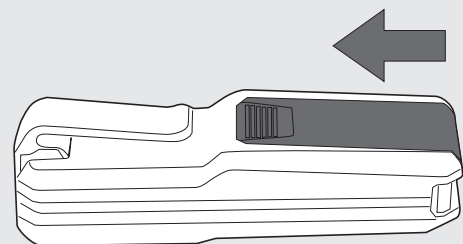

ROHOVÝ KOLÍK

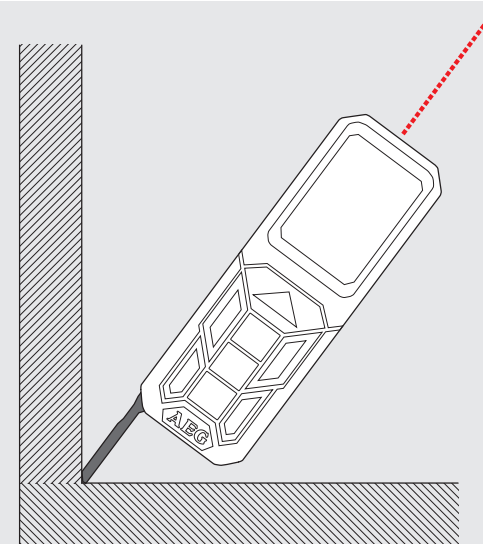
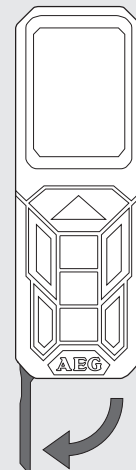

DRŽIAK NA OPASOK

1

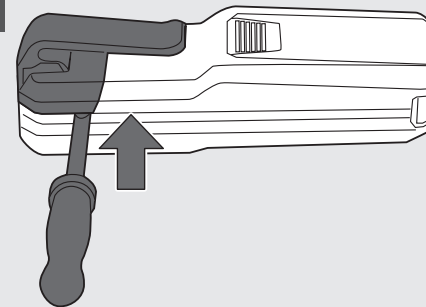

2

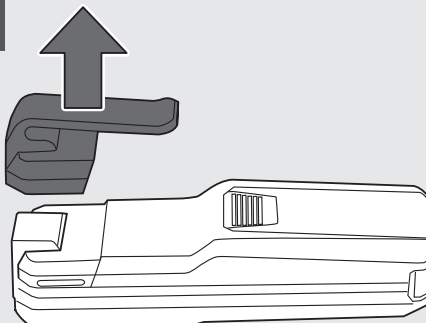

3

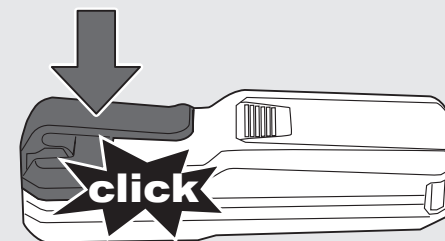

FUNKČNÉ TLACIDLO, FUNKCIA PYTAGORAS, ÚROVEŇ MERANIA

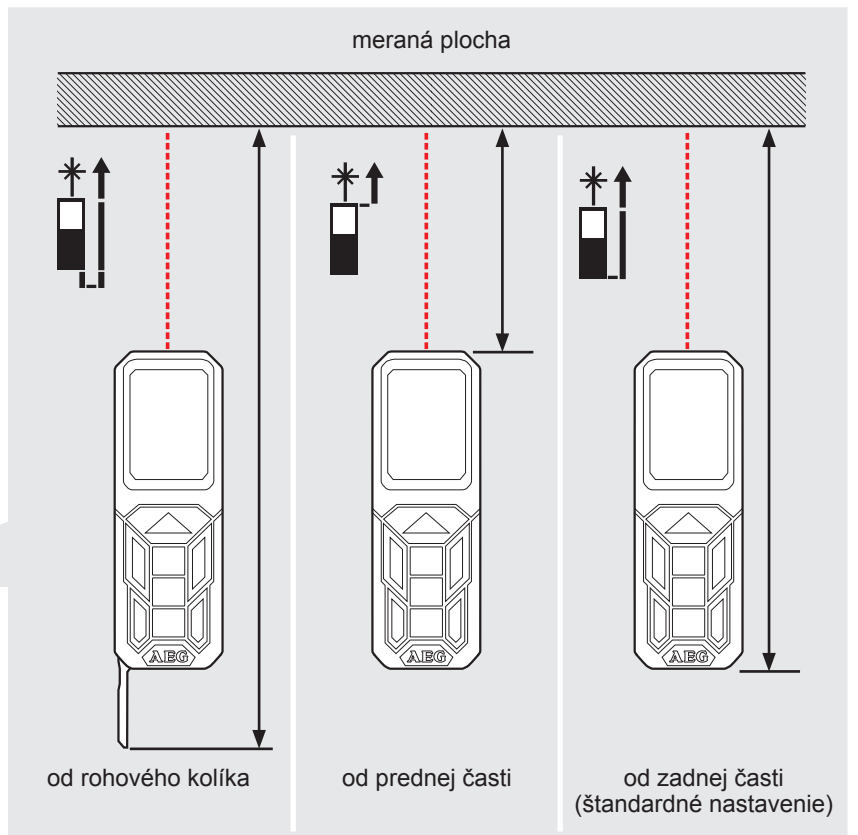
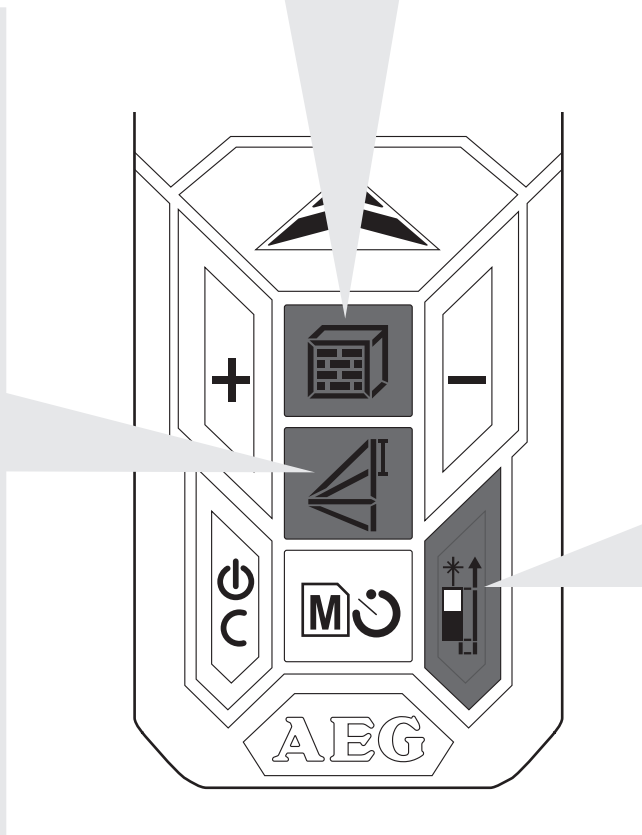
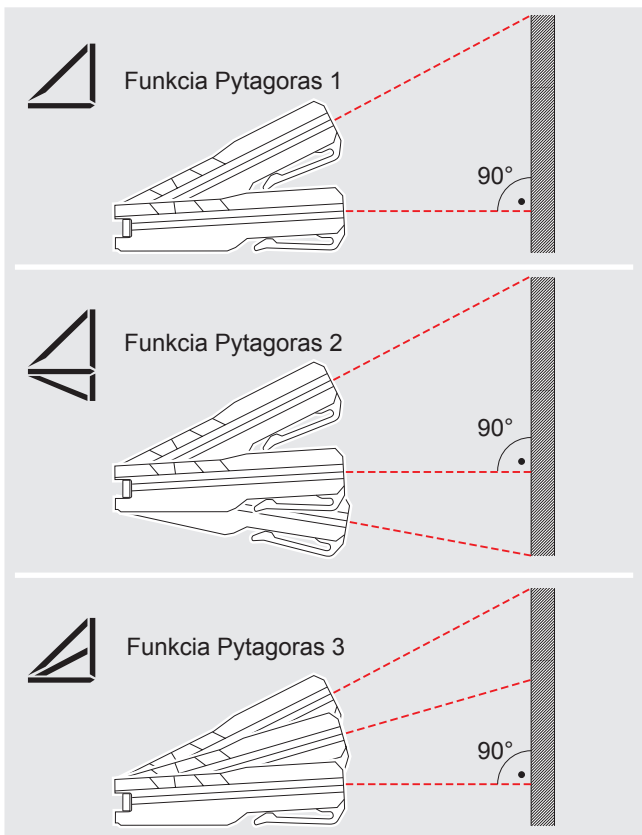
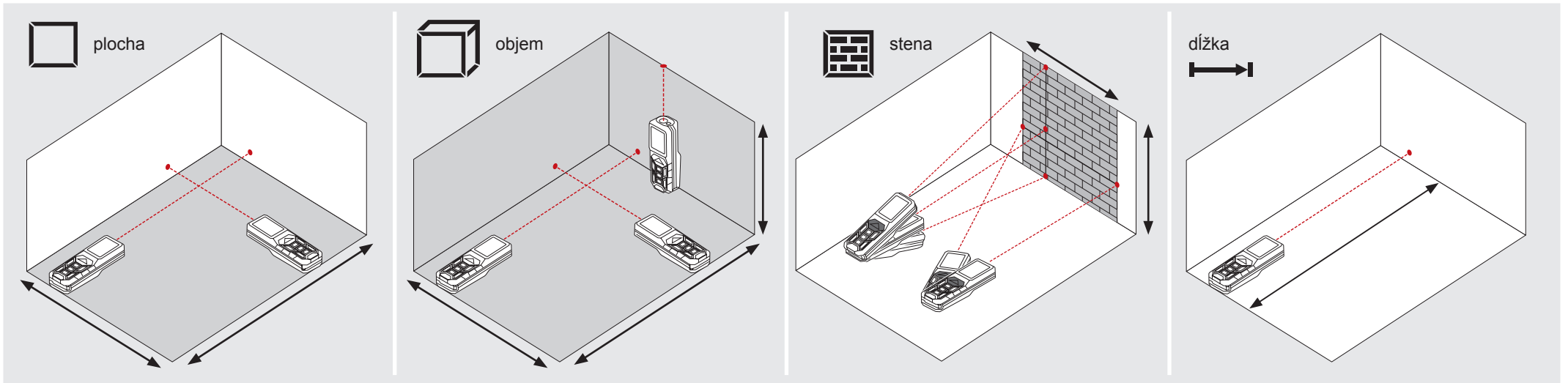

JEDNODUCHÉ MERANIE DĹŽKY

0

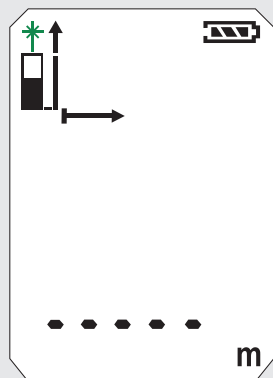

1

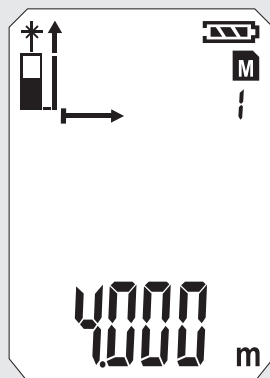
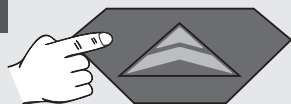

2

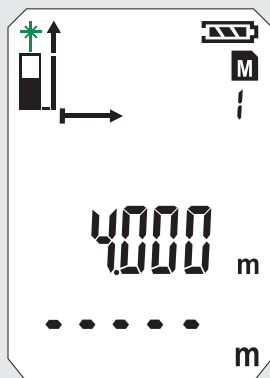
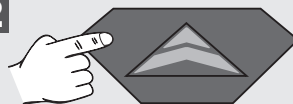

3

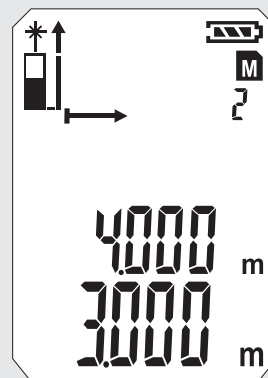
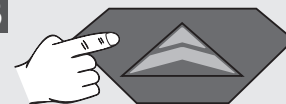

4

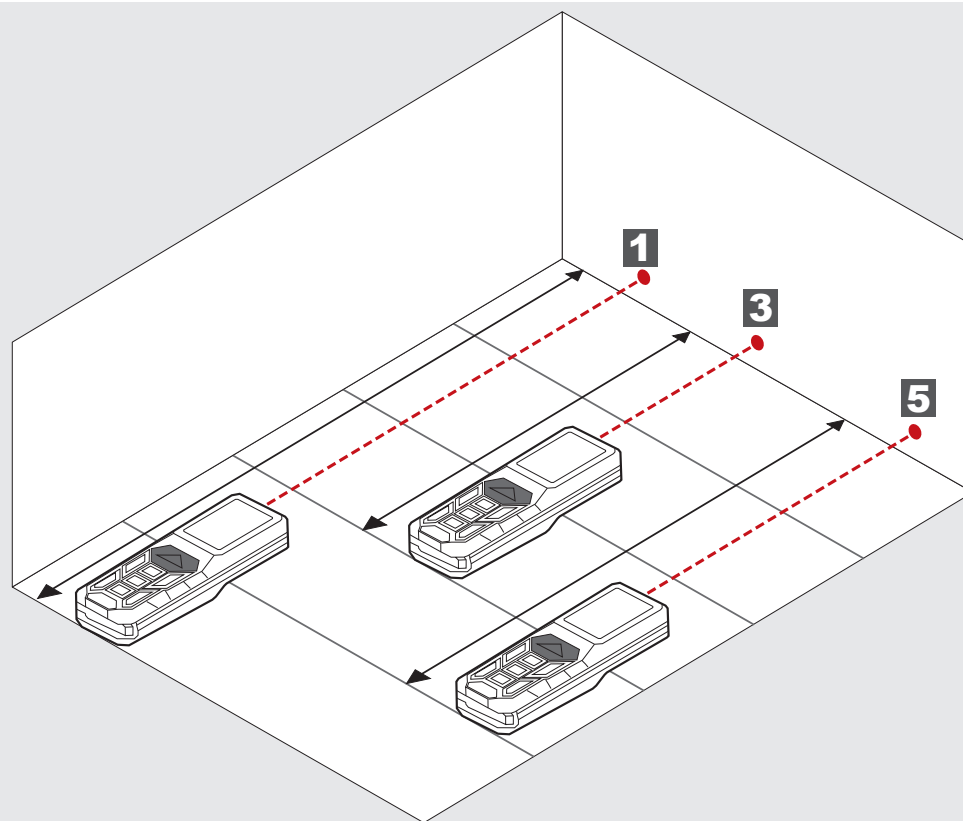
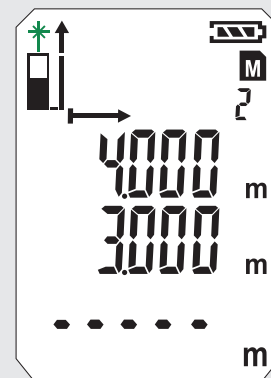
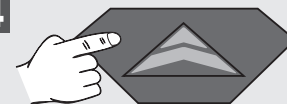

5

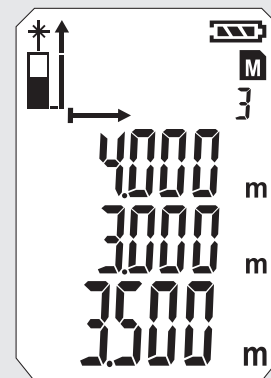
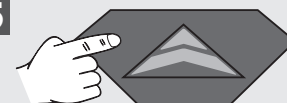

KONTINUALNE MERANIE / MERANIE MINIMA - MAXIMA

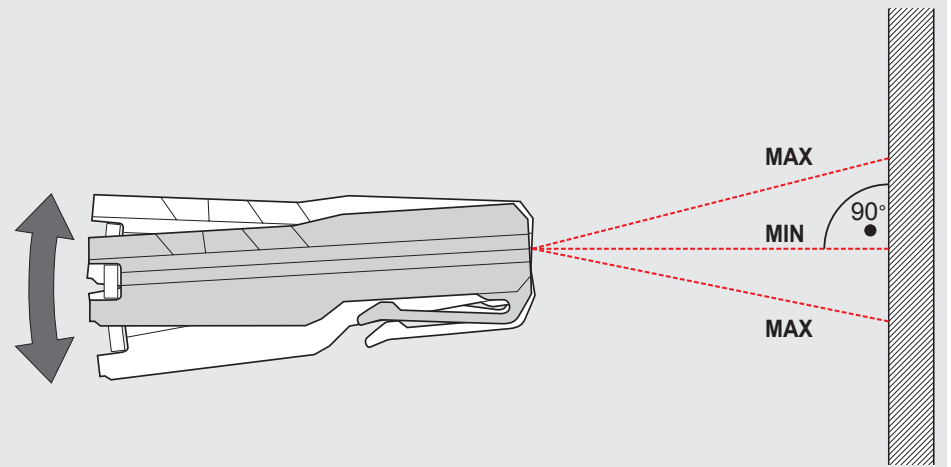
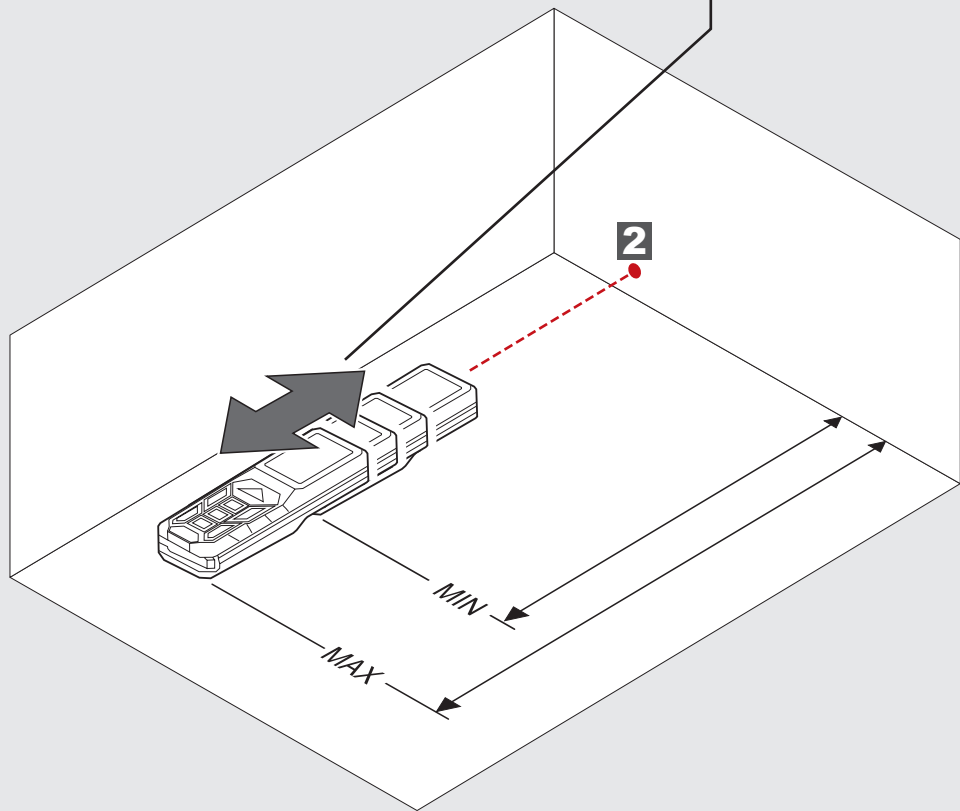
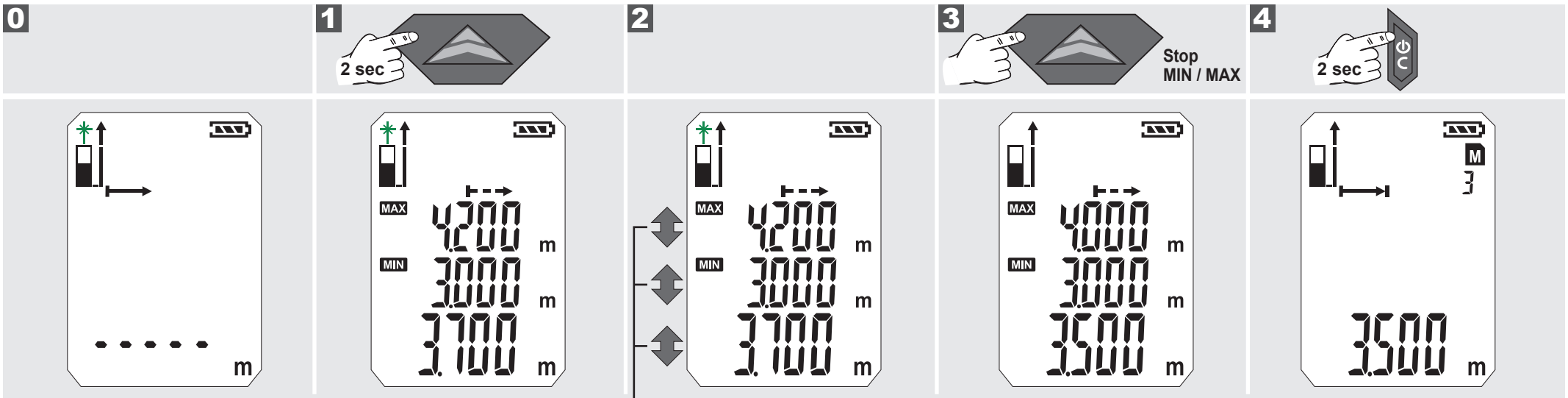

0

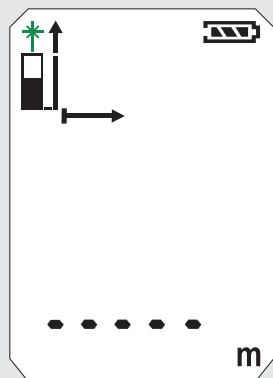

1

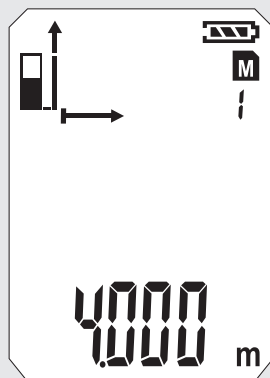
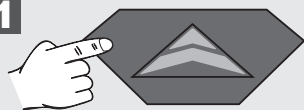

2

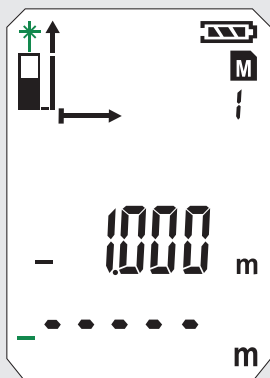
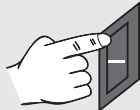

3

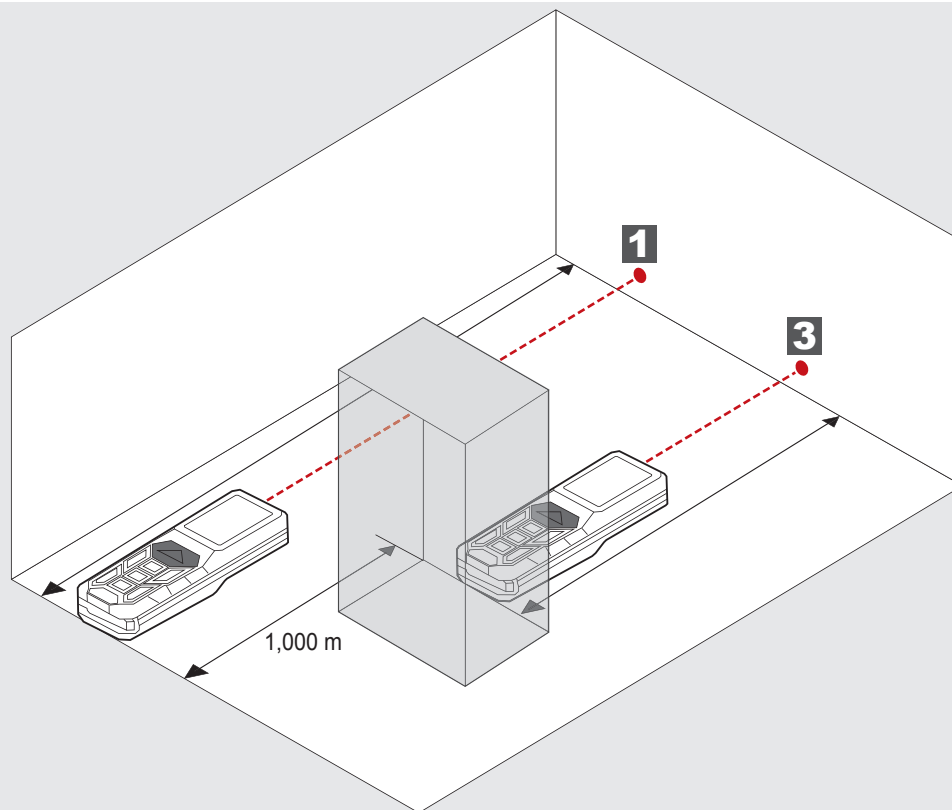
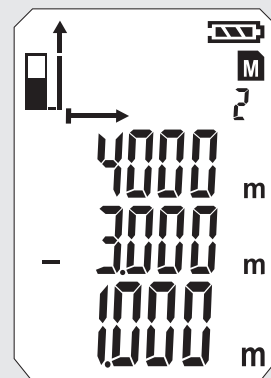
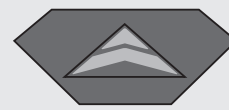

0



1

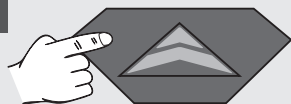

2

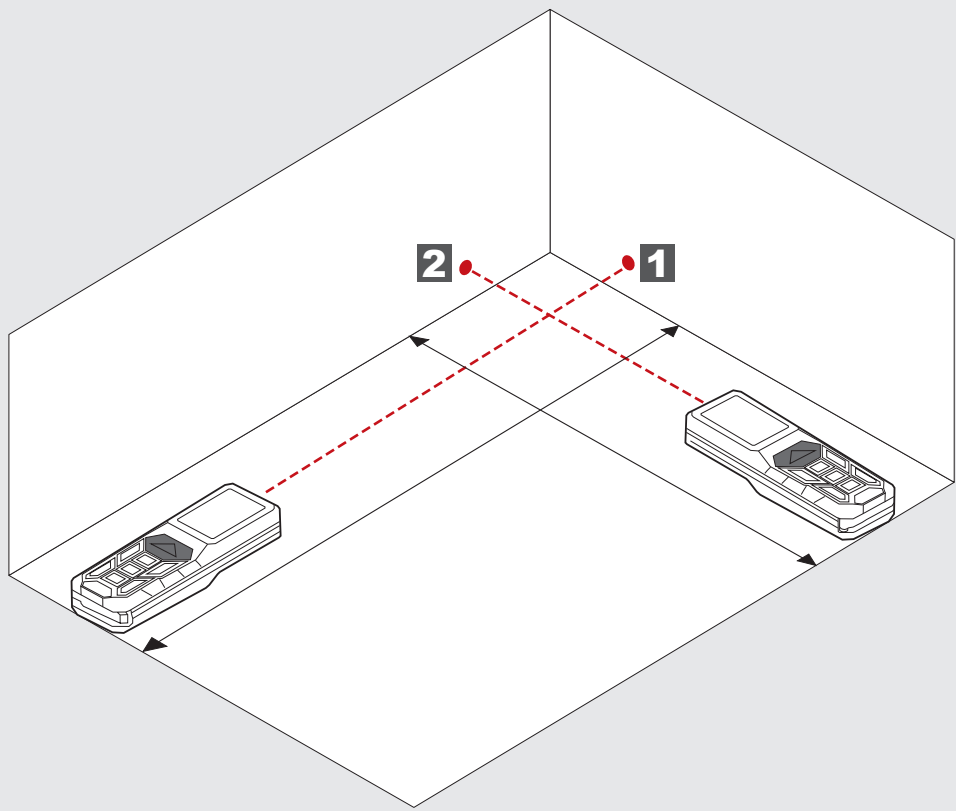
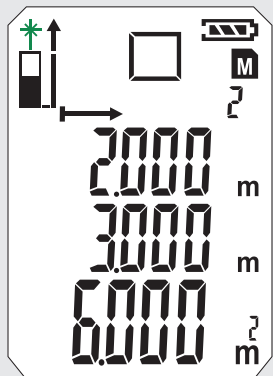
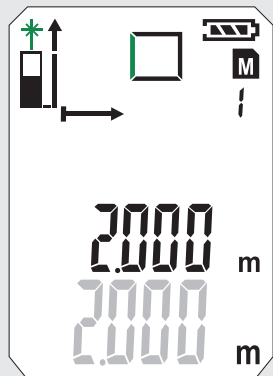
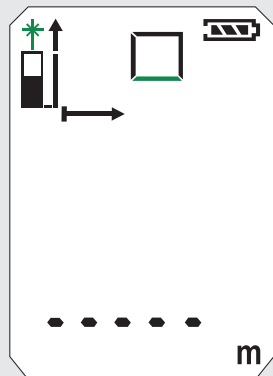
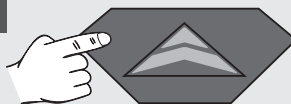

MERANIE OBJEMU

0



1

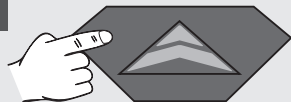

2

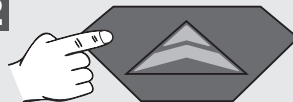

3

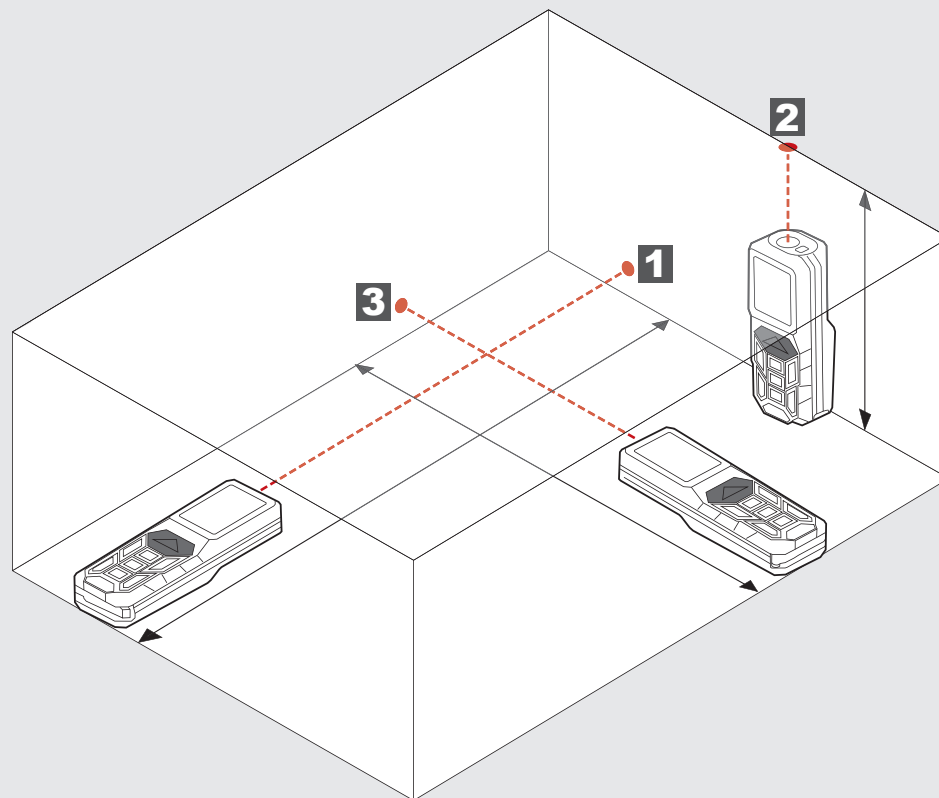
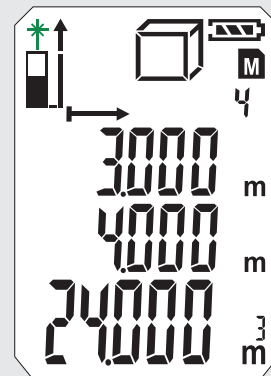
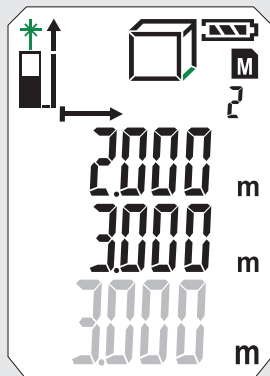
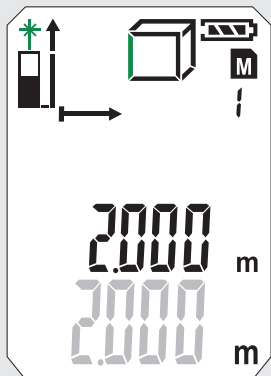
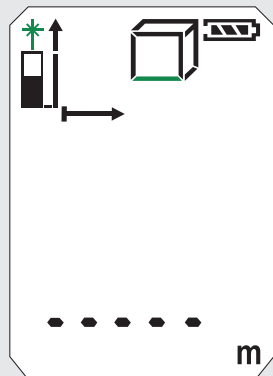
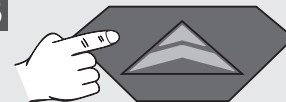

NEPRIAME MERANIE (FUNKCIA PYTAGORAS 1)

0



1

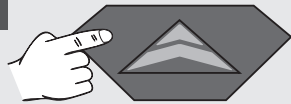

2

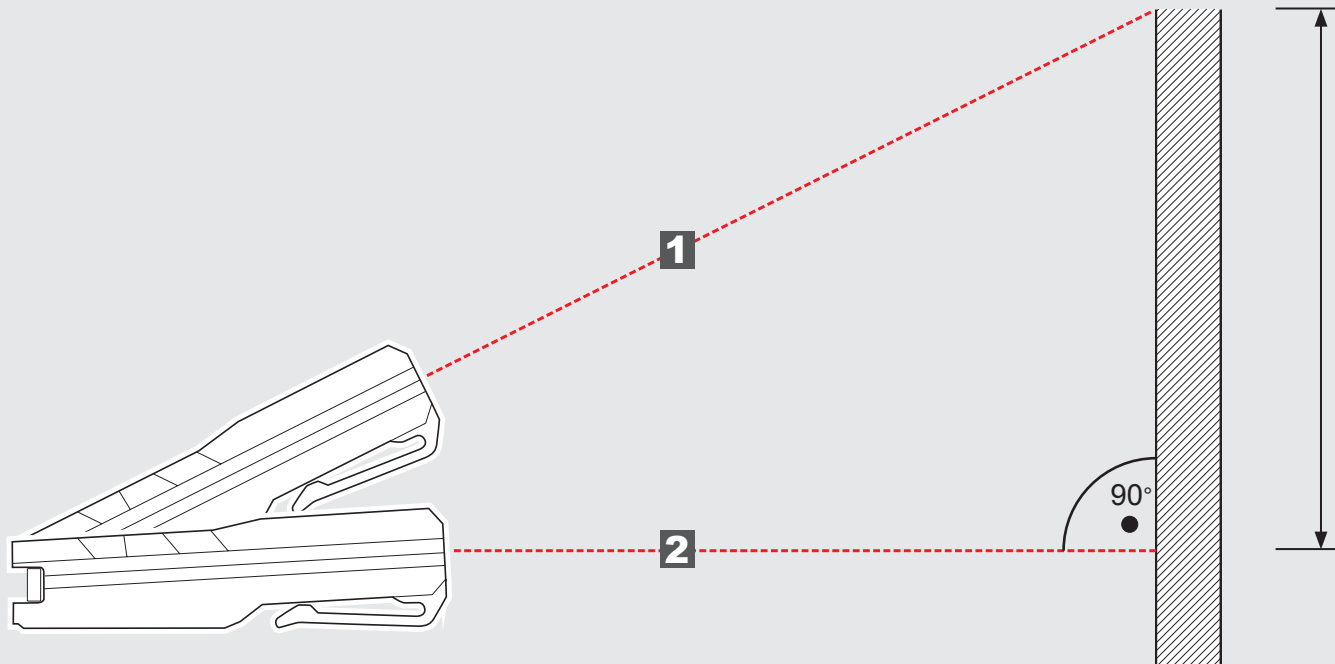
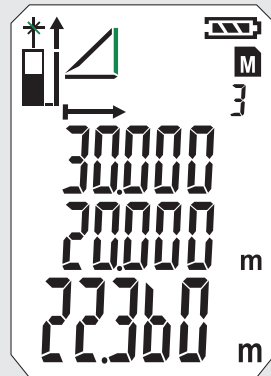
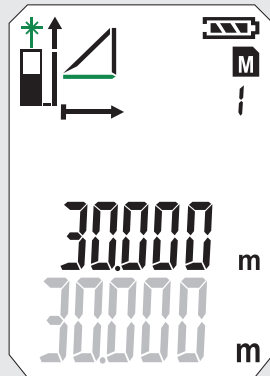
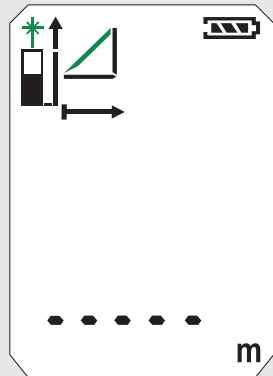
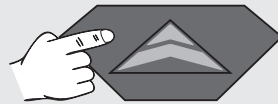

NEPRIAME MERANIE (FUNKCIA PYTAGORAS 2)

0



1

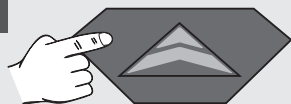

2



3

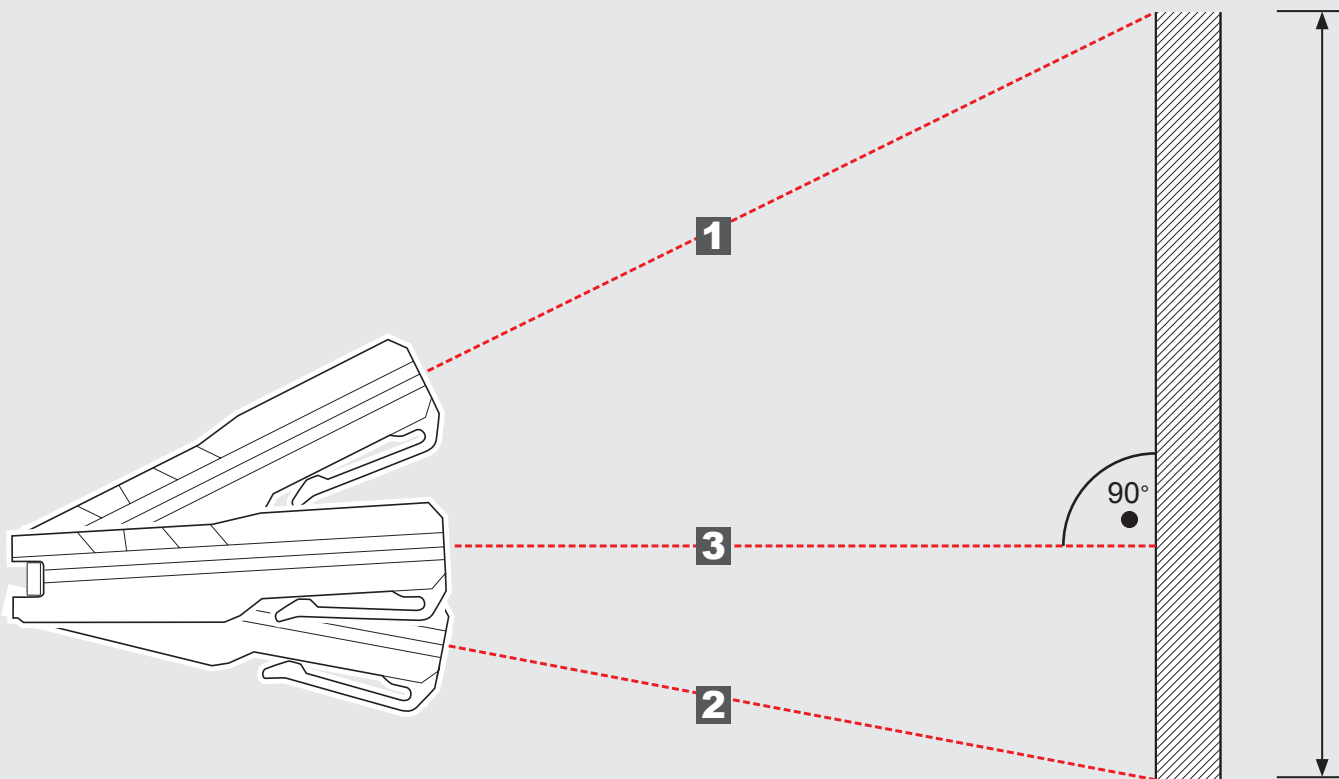
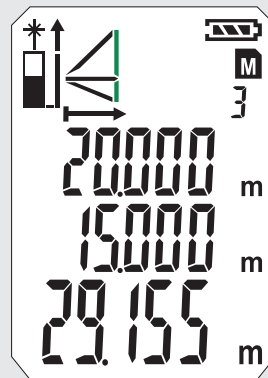
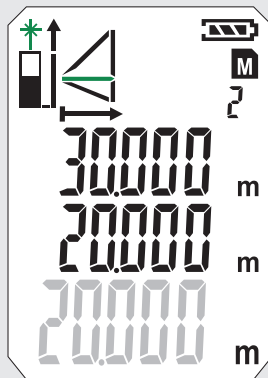
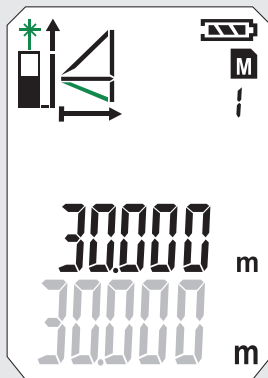
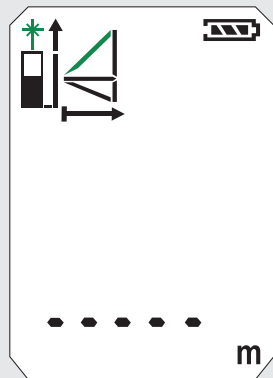

NEPRIAME MERANIE (FUNKCIA PYTAGORAS 3)

1



2

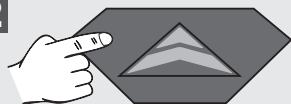



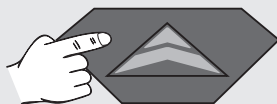



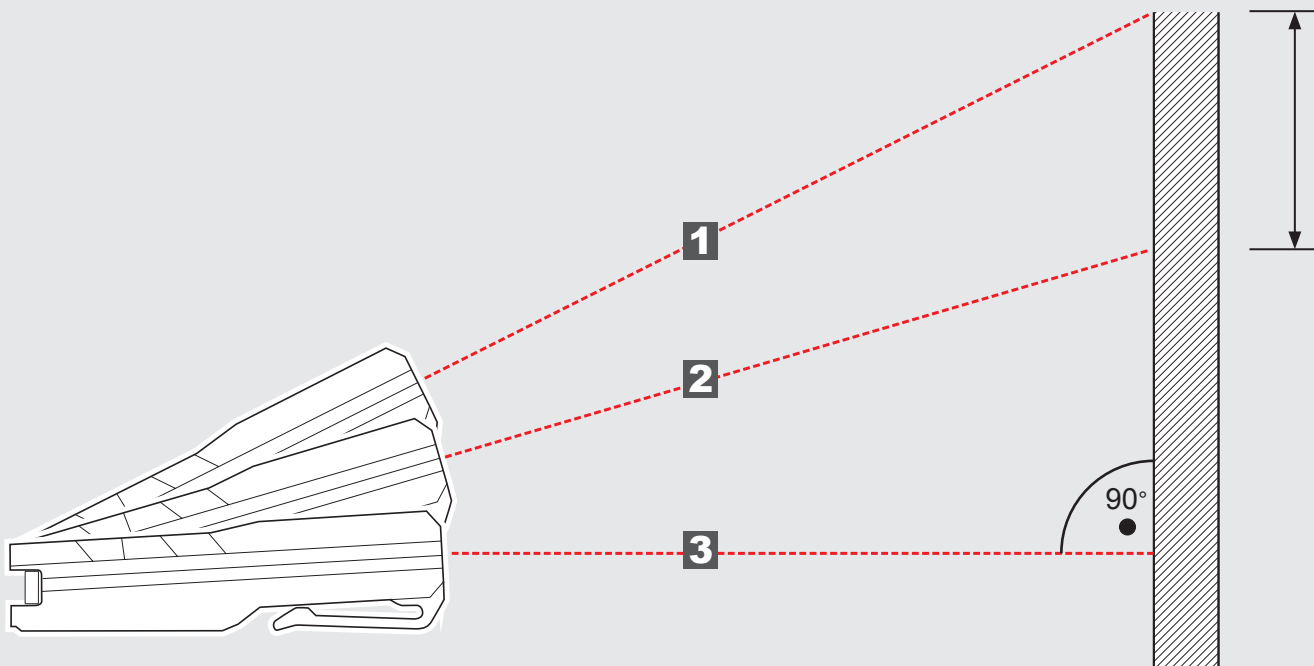
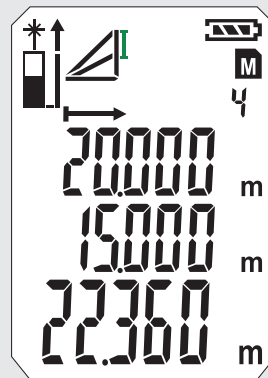
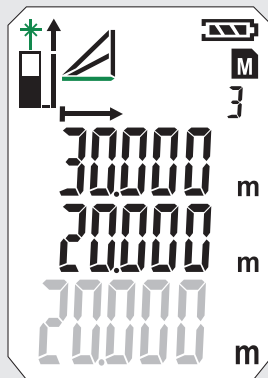
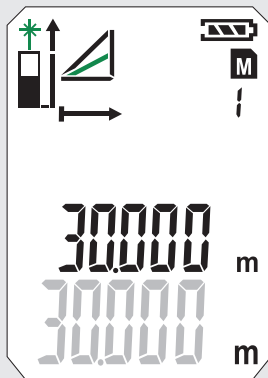
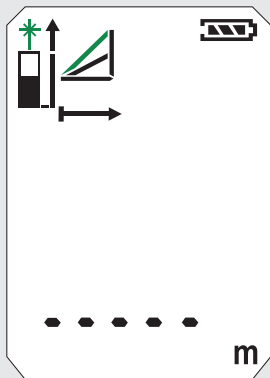







3

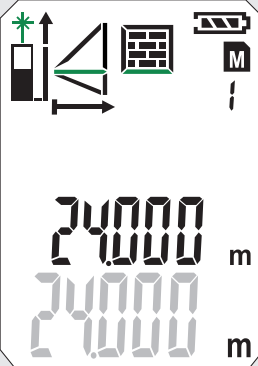

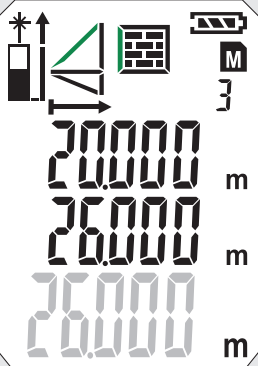
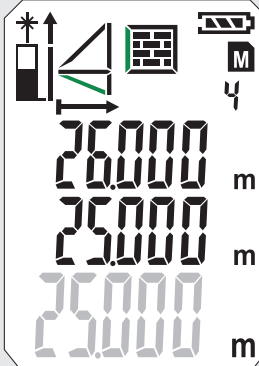
4



MERANIE PLOCHY STENY (SCENÁR 1)

0 	1 	2 	3 	4 
 	 	 	 	 

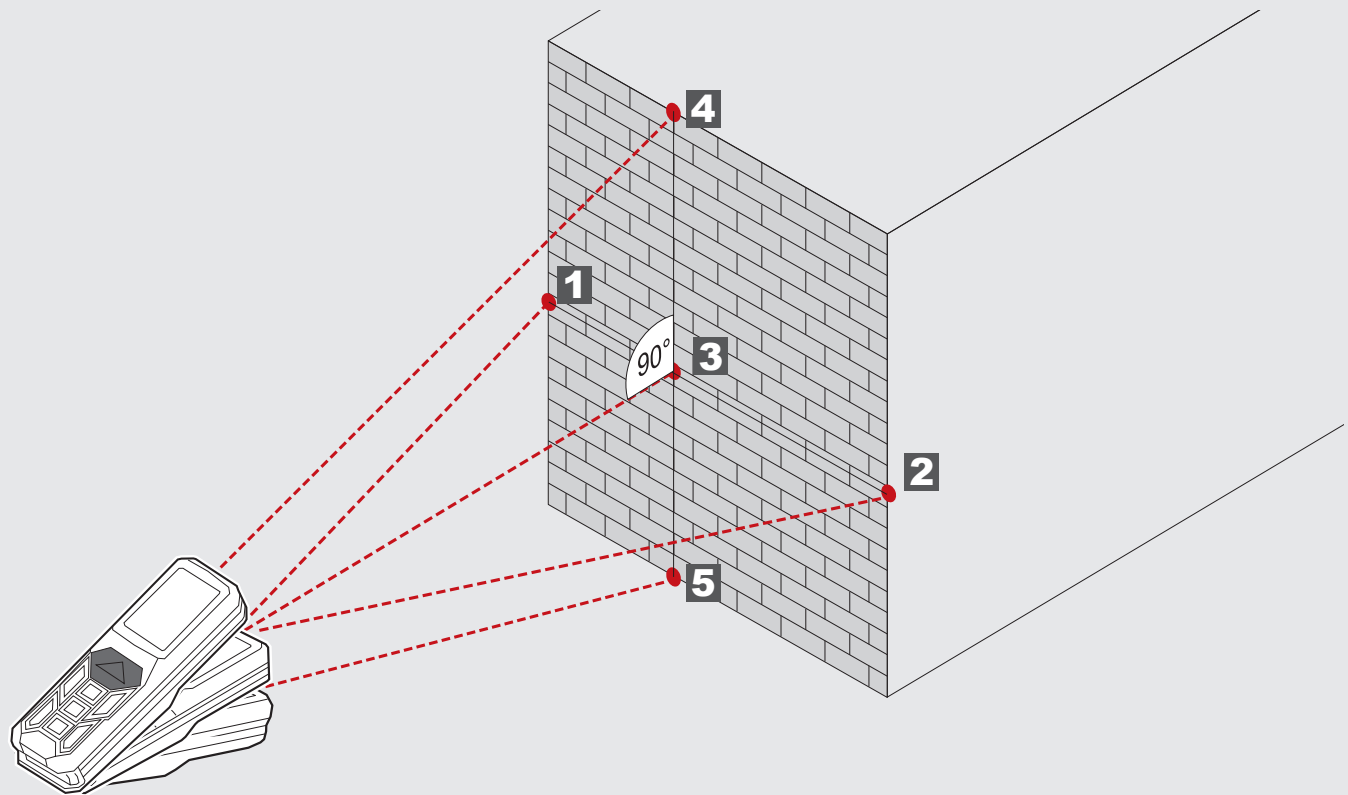



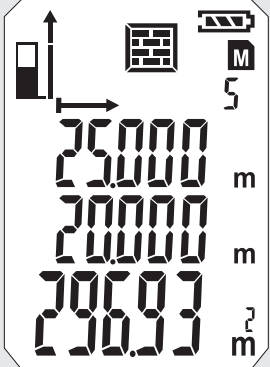

A 3D perspective diagram of a brick wall. A measuring device is positioned in the foreground. Red dashed lines represent laser beams from the device to five points on the wall labeled 1, 2, 3, 4, and 5. Point 3 is the starting point, and point 4 is directly above it. A 90-degree angle is indicated between the vertical line from 3 to 4 and the horizontal line from 3 to 2. Point 5 is below point 3. Point 2 is to the right of point 3.

5

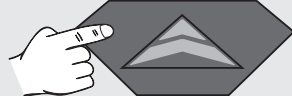
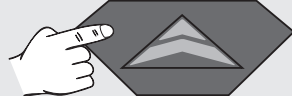
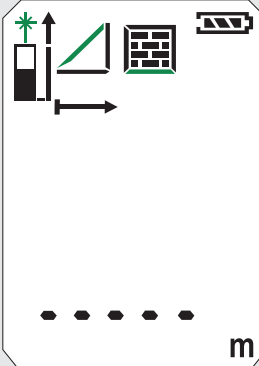
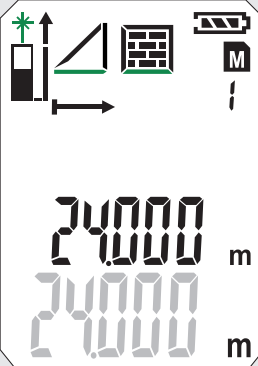
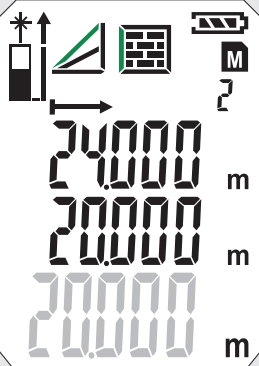
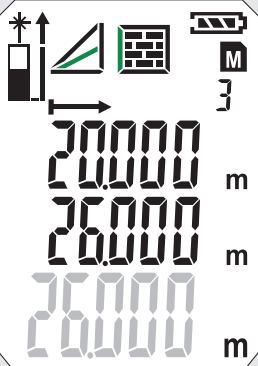
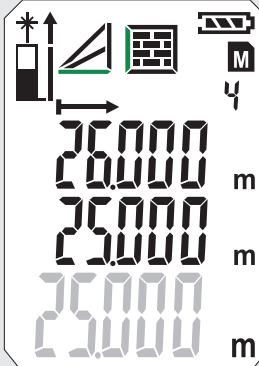

MERANIE PLOCHY STENY (SCENÁR 2)

0 	1 	2 	3 	4 
				

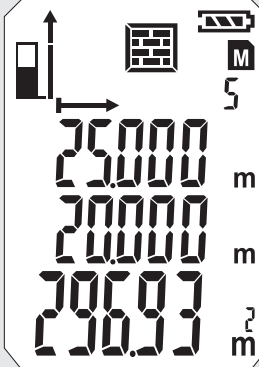

5





CASOVAC

Pomocou časovača sa dá meranie spustiť s neskorším štartom, aby sa napr. na konštrukčný diel mohol umiestniť meraný lúč.

Stlačte tlačidlo 

- Objaví sa symbol  sa stlačením tlačidla  časovač dá nastaviť v rozpätí od 3 do 15 sekúnd.

Stlačte tlačidlo 

- Sekundy budú odpočítavané do merania.
- Pri 0 sa spustí meranie.

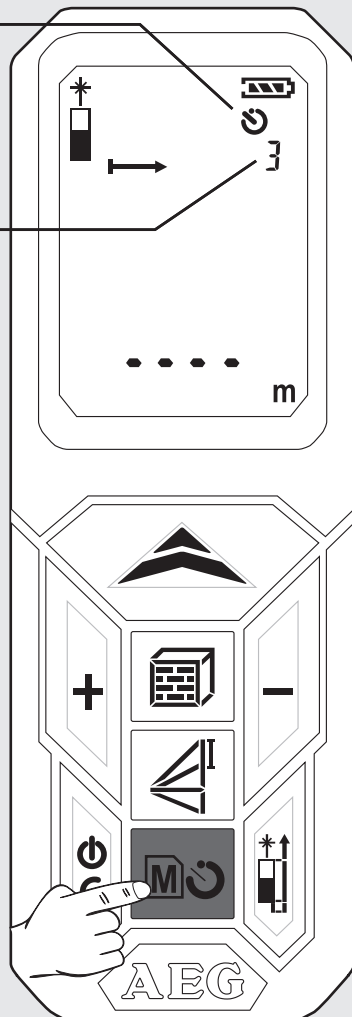

PAMÄŤ

Namerané hodnoty sa automaticky priebežne ukladajú do pamäte.

V pamäti uložené hodnoty si možno vyvolať tlačidlom .

Stlačte tlačidlo  na 2 sekundy

- Objaví sa symbol a miesto v pamäti.
- Zobrazí sa príslušná meraná veličina.
- V pamäti uložená hodnota sa zobrazí v hlavnom riadku.
- Pomocou tlačidiel +/- sa naviguje

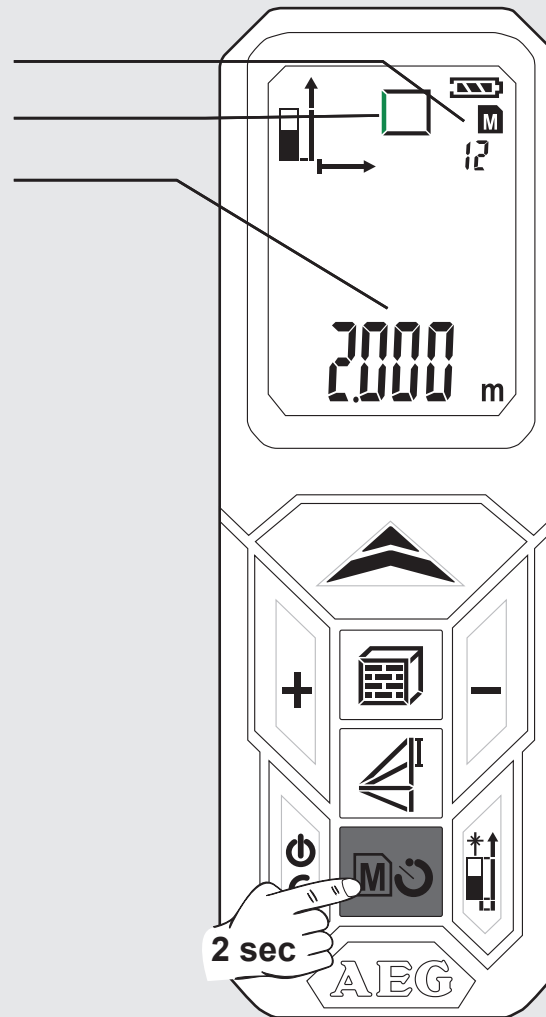

ZÁKLADNÝ SPŮSOB FUNGOVANIA NA PŘÍKLADE MERANIA PLOCHY (1)



1 Zapnutie

Stlačte tlačidlo .

⚠ Pozor! Laserový lúč je zapnutý!
Nemierite ním na osoby!

2 Výber úrovne merania

Po zapnutí štandardné nastavenie: meranie od zadnej časti merača

-  stlačiť 1x -> od rohového kolíka
-  stlačiť 2x -> meranie od prednej časti merača
-  stlačiť 3x -> meranie od zadnej časti merača

3 Výber funkcie

Po zapnutí je prístroj vždy nastavený na meranie dĺžky.
 stlačiť 1x - meranie plochy

4 Meranie dĺžky

Prístroj vyrovnejte a stlačte tlačidlo 

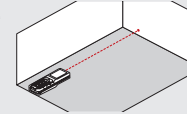

5 Meranie šírky

Prístroj vyrovnejte a stlačte tlačidlo 

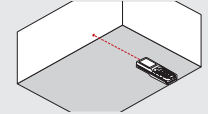

Bliká symbol lasera (blikanie zobrazené zelenou farbou).

Zobrazí sa symbol

- Objaví sa symbol
- Bliká meraná veličina (blikanie zobrazené zelenou farbou)

- Nameraná hodnota sa krátko zobrazí v hlavnom riadku.
- Nameraná hodnota po 1 sekunde preskočí do riadku ležiaceho vyššie.
- Nameraná hodnota sa uloží do pamäte pod poradovým číslom.
- Bliká druhá meraná veličina. Prístroj je pripravený na meranie druhej hodnoty.

- Nameraná hodnota sa krátko zobrazí v hlavnom riadku.
- Nameraná hodnota po 1 sekunde preskočí do riadku ležiaceho vyššie.
- Nameraná hodnota sa uloží do pamäte pod poradovým číslom.
- Výsledok sa zobrazí v hlavnom riadku a uloží sa do pamäte pod poradovým číslom.

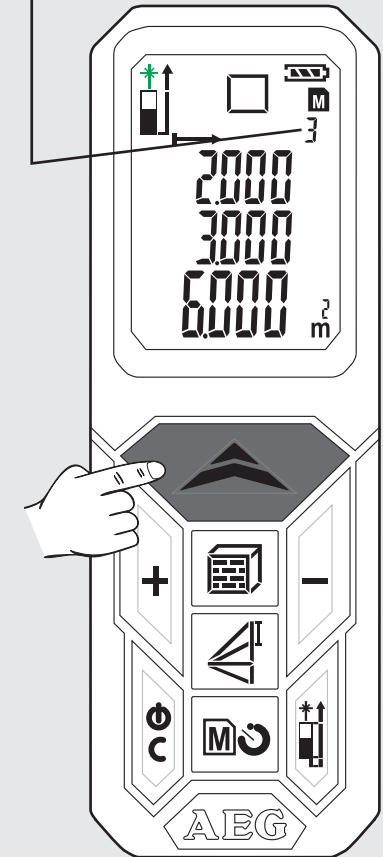
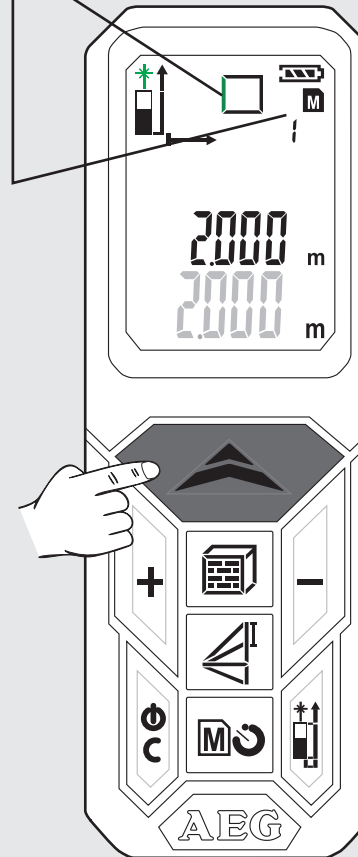
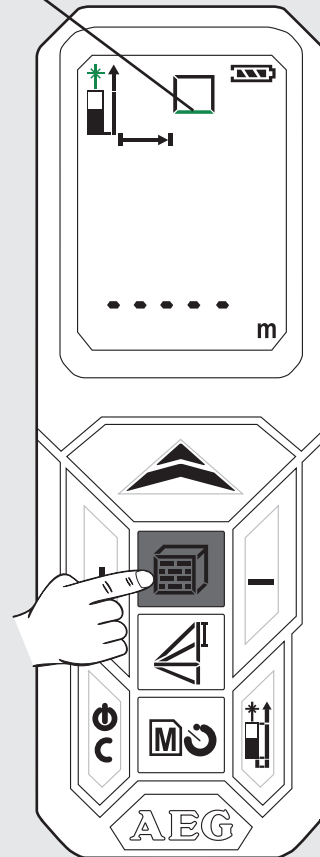
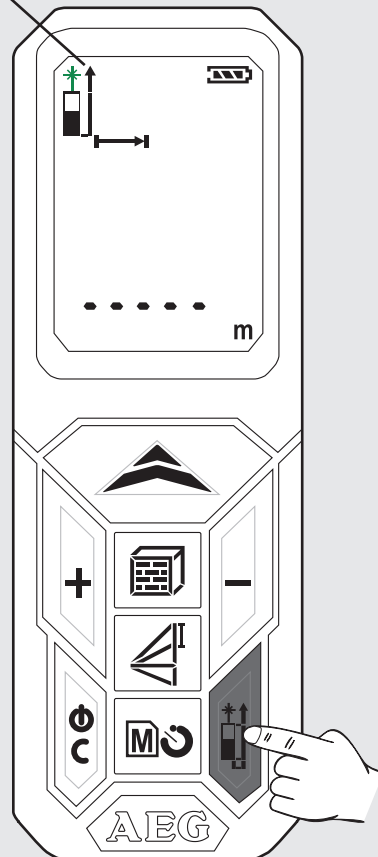
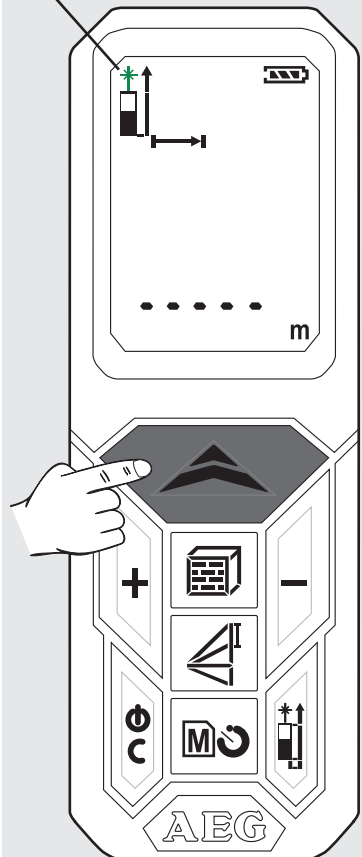

ZÁKLADNÝ SPÔSOB FUNGOVANIA NA PŘÍKLADE MERANIA PLOCHY (2)

6 Vypovanie hodnôt uložených v pamäti

Tlačidlo  stlačte na 2 sekundy.

Stlačte tlačidlo + alebo -

- Hodnoty uložené v pamäti sa zobrazia v hlavnom riadku.

- Zobrazí sa príslušný symbol a bliká meraná veličina (blikanie zobrazené zelenou farbou).

7 Opustenie pamäte

Stlačte tlačidlo .

8 Vypnutie

Tlačidlo  stlačte na 2 sekundy (Predtým sa musí odísť z pamäte).

- Prístroj sa vypne.

- Ak sa v priebehu 3 minút nestlačí žiadne tlačidlo, prístroj sa vypne automaticky.

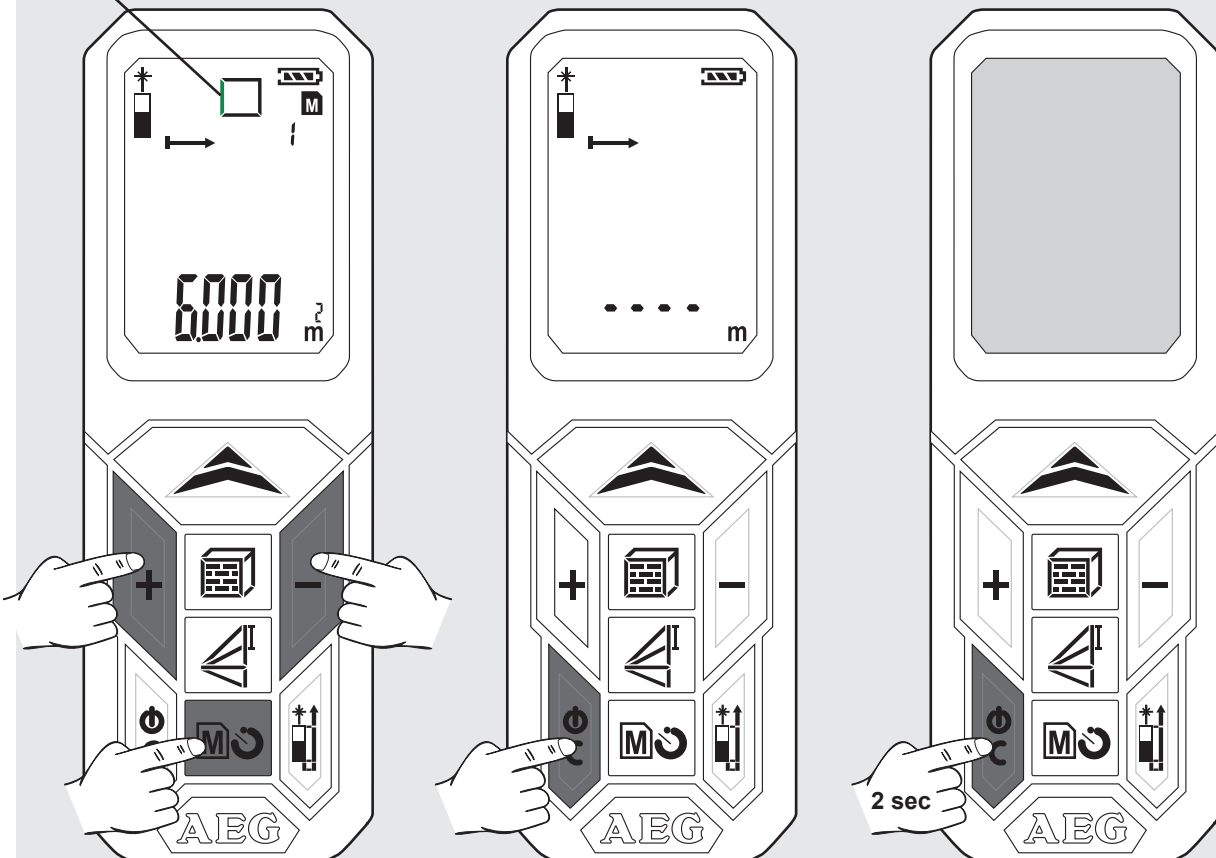

TREŚĆ

Ważne wskazówki bezpieczeństwa.....	1
Dane techniczne.....	2
Warunki użytkowania.....	2
Tabela kodów błędów.....	2
Zestawienie.....	3
Wymiana baterii.....	4
Kołek kątowy.....	4
Pasek uchwytu.....	4
Przycisk funkcyjny, pomiar pośredni wartości geometrycznych, płaszczyzna pomiaru.....	5
Zwykły pomiar długości.....	6
Pomiar ciągły / Pomiar Minimum-Maksimum.....	7
Pomiar sumujący / różnicujący.....	8
Pomiar powierzchni.....	9
Pomiar objętości.....	10
Pomiar pośredni (wartości geometrycznych 1).....	11
Pomiar pośredni (wartości geometrycznych 2).....	12
Pomiar pośredni (wartości geometrycznych 3).....	13
Pomiar powierzchni ściany (scenariusz 1).....	14
Pomiar powierzchni ściany (scenariusz 2).....	15
Zegar sterujący.....	16
Pamięć.....	16
Zasadniczy sposób działania na przykładzie pomiaru powierzchni (1).....	17
Zasadniczy sposób działania na przykładzie pomiaru powierzchni (2).....	18

WAŻNE WSKAZÓWKI BEZPIECZEŃSTWA



Urządzenia nie wolno używać przed zapoznaniem się z treścią procedur bezpieczeństwa oraz instrukcji obsługi znajdującej się na dołączonej płycie CD.

Klasyfikacja lasera

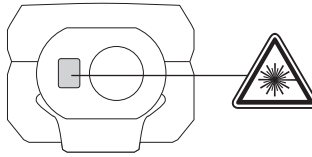

OSTRZEŻENIE:

Urządzenie emituje laser klasy 2 w zgodności z normą IEC 60825-1:2007.



Napisy

Przed pierwszym uruchomieniem należy nakleić na angielski tekst tabliczki mocy załączoną naklejkę w języku Pańskiego kraju.

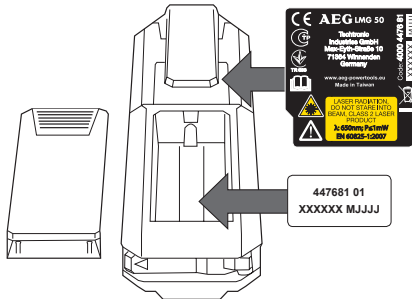

Ostrzeżenie:

Unikać bezpośredniego kontaktu wzrokowego. Promień lasera może porazić oczy i prowadzić do krótkotrwałego oślepienia.

Nie wolno spoglądać bezpośrednio w wiązkę lasera lub też kierować jej niepotrzebnie w stronę innych osób.

Nie wolno oślepiać laserem innych osób.

Ostrzeżenie:

Niniejsze urządzenie laserowe nie może być eksploatowane w pobliżu dzieci.

Nie wolno też pozwolić dzieciom na użytkowanie niniejszego urządzenia.

Uwaga! Powierzchnia odbijająca promienie mogłaby spowodować odbicie promienia lasera z powrotem ku osobie obsługującej urządzenie lub ku innym osobom.

Należy uważać, aby nie dotykać poruszających się części urządzenia.

Należy przeprowadzać okresowe testy kontrolne. Czynność tę powtarzać bezpośrednio przed wykonaniem ważnych pomiarów, w ich trakcie oraz po zakończeniu.

Zwrócić szczególną uwagę na okoliczność wystąpienia błędów pomiarowych, szczególnie gdy instrument został wcześniej uszkodzony lub upuszczony na ziemię również wówczas gdy został użyty niezgodnie z przeznaczeniem lub był poddany modyfikacjom.

Uwaga! Należy zapoznać się z elementami sterującymi i prawidłową obsługą narzędzia ogrodowego.

Miernik laserowy ma ograniczony zakres zastosowania. (Patrz rozdział "Dane techniczne"). Próby dokonywania pomiarów poza maksymalnym i minimalnym zakresem powodują niedokładności. Zastosowanie w niekorzystnych warunkach, takich jak: wysoka lub zbyt niska temperatura, zbyt jaskrawe światło słoneczne, deszcz, śnieg, mgła lub w innych warunkach ograniczenia widoczności mogą prowadzić do niedokładnych pomiarów.

W przypadku przeniesienia miernika laserowego z ciepłego do zimnego otoczenia (lub odwrotnie) należy odczekać, dopóki miernik nie dostosuje się do nowej temperatury otoczenia.

Miernik laserowy należy zawsze przechowywać w pomieszczeniach, należy go chronić przed wstrząsami, wibracjami lub ekstremalnymi temperaturami.

Miernik laserowy należy chronić przed zapyleniem, wilgocią i wysoką wilgotnością powietrza. Może to powodować uszkodzenie wewnętrznych elementów lub mieć niekorzystny wpływ na dokładność.

Nie należy używać żadnych agresywnych środków czyszczących lub rozpuszczalników. Czyścić tylko czystą, miękką ściereczką.

Unikać mocnych uderzeń lub upadków miernika laserowego. W przypadku upuszczenia na ziemię lub innych narażeń mechanicznych należy sprawdzić dokładność przyrządu.

Niezbędne naprawy urządzenia laserowego mogą być wykonywane wyłącznie przez autoryzowany personel specjalistyczny.

Urządzenia nie wolno używać w środowisku zagrożonym wybuchem lub w miejscu działania substancji żrących.

Do ładowania baterii należy używać wyłącznie ładowarek rekomendowanych przez producenta.



Nie wyrzucać wyczerpanych baterii wraz z odpadami domowymi. Dla zapewnienia ochrony środowiska należy zanieść je do punktu zbiórki elektroodpadów zgodnie z przepisami krajowymi lub lokalnymi. Nie wyrzucać lasera wraz z odpadami domowymi.

Produkt należy utylizować zgodnie z przepisami obowiązującymi w kraju użytkowania. Przestrzegać obowiązujących przepisów krajowych. Aby uzyskać informacje dot. usuwania zużytych baterii do odpadów należy skontaktować się z lokalnymi władzami albo ze sprzedawcą.



DANE TECHNICZNE

Klasa ochrony	IP54 ochrona przed zapyleniem i wodą rozpryskową)
Układ optyczny	14 mm
Ognisko	35 mm
Maksymalny zakres pomiarowy	50 metrów (tolerancja: 55m)
Minimalny zakres pomiarowy	0,05 metrów
Dokładność bezwzględna @ < 10m	± 1,5 mm (maks.)
Dokładność powtarzalności @ < 10m	± 1,5 mm (typowa maks. 2σ)
Dokładność powtarzalności @ > 10m	Przyrost ± 0,25 mm / metrów (typowa maks. 2σ)
Czas pomiaru	0,5 s
Wyświetlacz typ	LCD (22,7 mm x 31 mm)
Zasilanie prądowe	AAA 2x (bateria alkaliczna)
Trwałość baterii	10000 (pojedynczych pomiarów)
Moc wyjściowa lasera	0,6 mW ~ 0,95 mW (klasa 2, 650nm)
Wielkość punktu lasera	25 x 30 mm @ 16 m (maks.)
Kąt pionowy promienia lasera	+1 stopień
Kąt poziomy promienia lasera	±1 stopień
Automatyczne wyłączenie przyrządu	180 sekund
Automatyczne wyłączenie lasera	30 sekund
Zakres temperatury roboczej	-10°C do +50°C
Zakres temperatury przechowywania	-25°C do +70°C
Ciężar bez baterii	80 g

WARUNKI UŻYTKOWANIA

Miernik laserowy jest przeznaczony do pomiaru odległości i kątów nachylenia.
Produkt można użytkować wyłącznie zgodnie z jego normalnym przeznaczeniem.

TABELA KODÓW BŁĘDÓW

Opis	kodu	Rozwiązanie
Err01	Poza zakresem pomiarowym	Pomiar należy prowadzić w przewidzianym zakresie pomiarowym.
Err02	Odbity sygnał jest za słaby	Wybrać lepszą powierzchnię.
Err03	Poza zakresem wskazania (maks. wartość: 99.999) np. jeśli wynik powierzchni lub objętości jest poza zakresem wskazania	Należy sprawdzić, czy wartości i czynności są prawidłowe.
Err04	Błąd w obliczeniu wartości w przypadku pomiaru pośredniego	Należy sprawdzić, czy wartości i czynności są prawidłowe.
Err05	Słaba bateria	Założyć nową baterię.
Err06	Poza zakresem temperatury roboczej	Dokonywać pomiarów w podanym zakresie temperatur.
Err07	Światło otoczenia za jasne	Przyciemnić obszar celu.

Pomiar wartości pośrednich geometrycznych
Różnica wysokości

Płaszczyzna pomiaru

Pomiar długości

Minimum / Maksimum do pomiaru ciągłego

Dodawanie / Odejmowanie

WŁĄCZONE / POMIAR

- ▶ Włączone
- ▶ Pomiar
- ▶ Pomiar ciągły (naciśnięć i przytrzymać przez 2 sek.)
Funkcja Min. / Maks.

DODAWANIE

- ▶ Dodać wartość
- ▶ Poruszanie się po pamięci

POWIERZCHNIA / OBJĘTOŚĆ

- ▶ Powierzchnia (naciśnięć 1x)
- ▶ Objętość (naciśnięć 2x)
- ▶ Pośredni pomiar powierzchni (naciśnięć 3x / 4x)

WŁĄCZANIE

- ▶ Włączone
- ▶ Wyłączenie (naciśnięć przez 2 sek.)
- ▶ Zerowanie

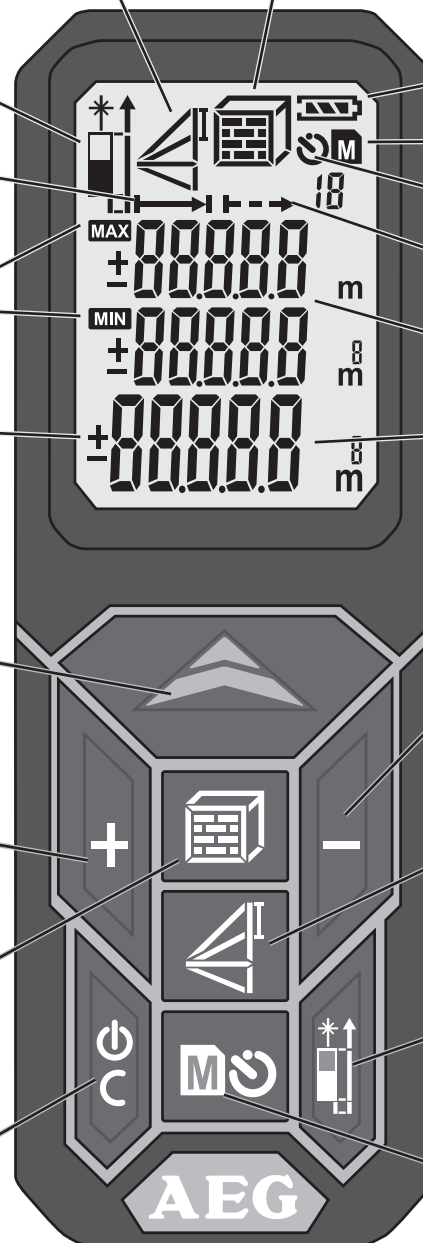

Powierzchnia / Objętość
Pośredni pomiar powierzchni

Status baterii

Pamięć

Zegar sterujący

Pomiar ciągły

Wartości pośrednie

Wartość całkowita

ODEJMOWANIE

- ▶ Odejmowanie wartości
- ▶ Poruszanie się po pamięci

POMIAR POŚREDNI WARTOŚCI GEOMETRYCZNYCH

- ▶ Pomiar pośredni wartości geometrycznych 1 (naciśnięć 1x)
- ▶ Pomiar pośredni wartości geometrycznych 2 (naciśnięć 2x)
- ▶ Pomiar pośredni wartości geometrycznych 3 (naciśnięć 3x)

ZMIANA PŁASZCZYZNY POMIARU

- ▶ Przód
- ▶ Tył
- ▶ Kołek kątowy

PAMIĘĆ

- ▶ Zegar sterujący 3-15 sek. (naciśnięć 1x)
- ▶ Zegar sterujący 1-20 (naciśnięć 1x 2 sek.)
- ▶ Poruszanie się po pamięci za pomocą przycisków +/-

WYMIANA BATERII

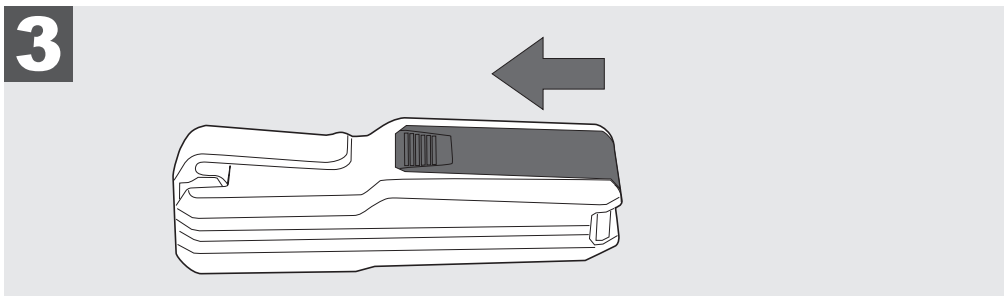
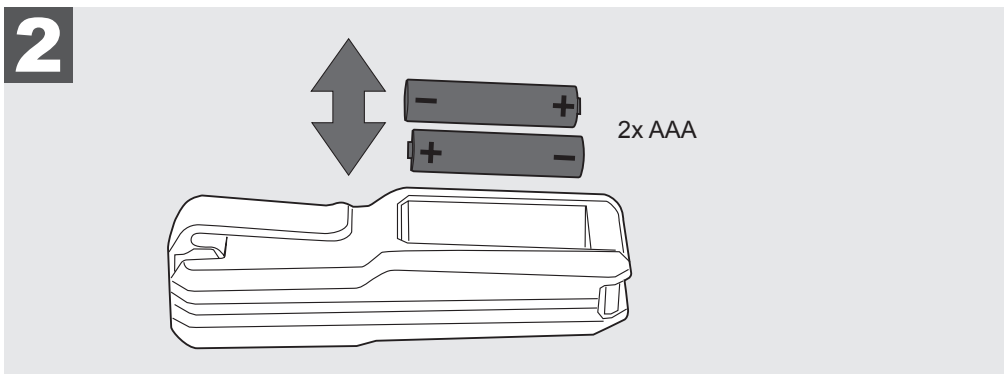
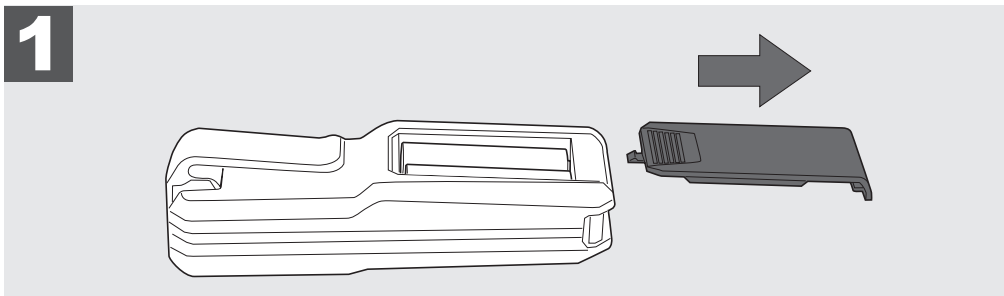
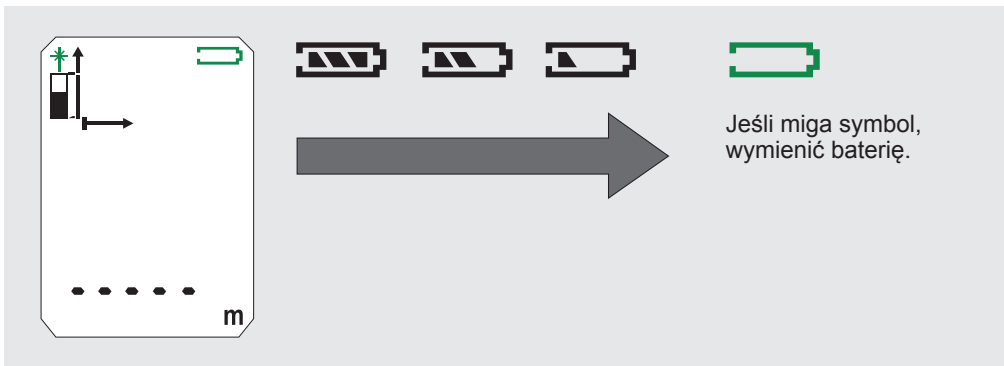

KOŁEK KĄTOWY

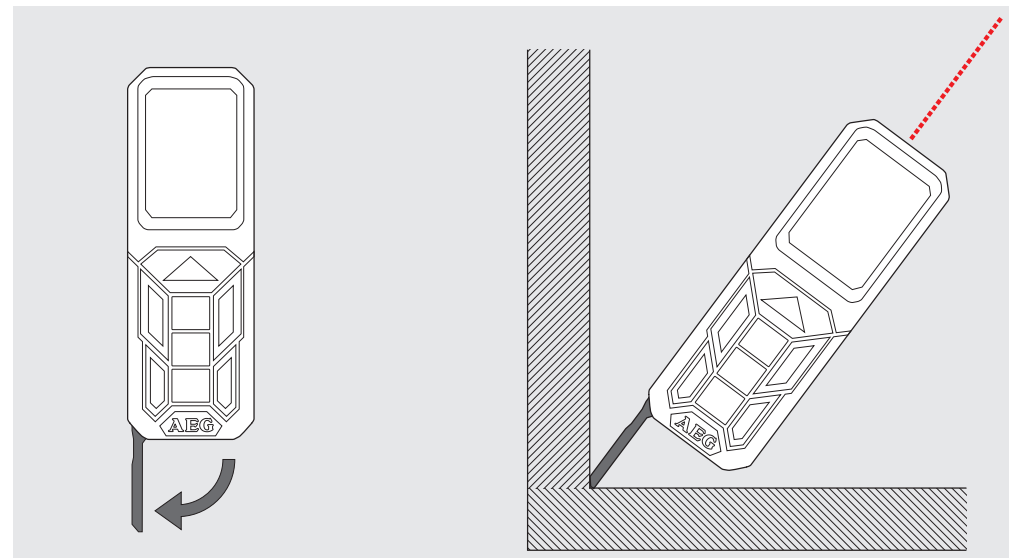

PASEK UCHWYTU

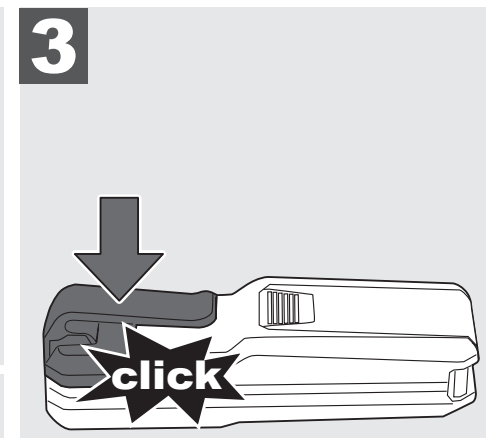
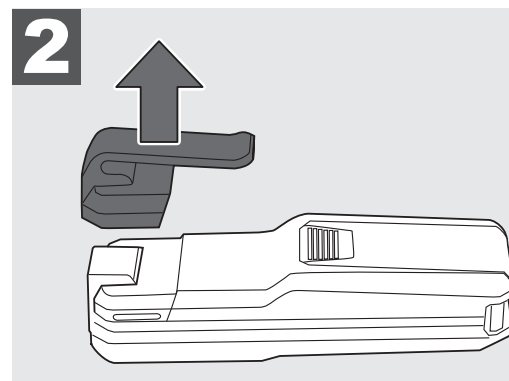
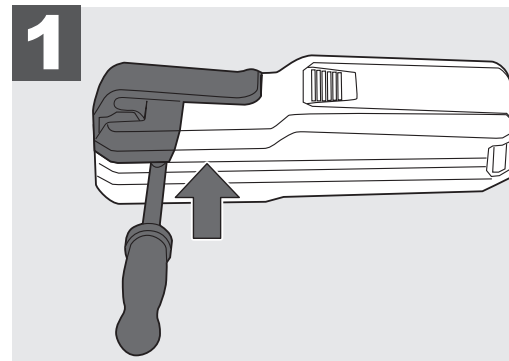

PRZYCISK FUNKCYJNY, POMIAR POŚREDNI WARTOŚCI GEOMETRYCZNYCH, PŁASZCZYNA POMIARU

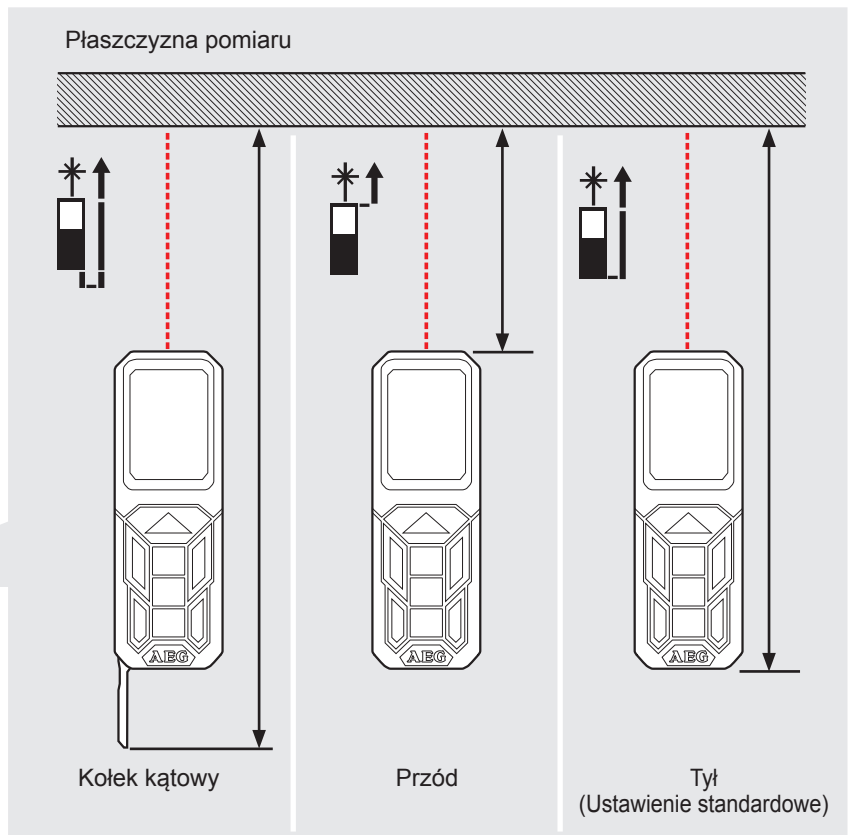
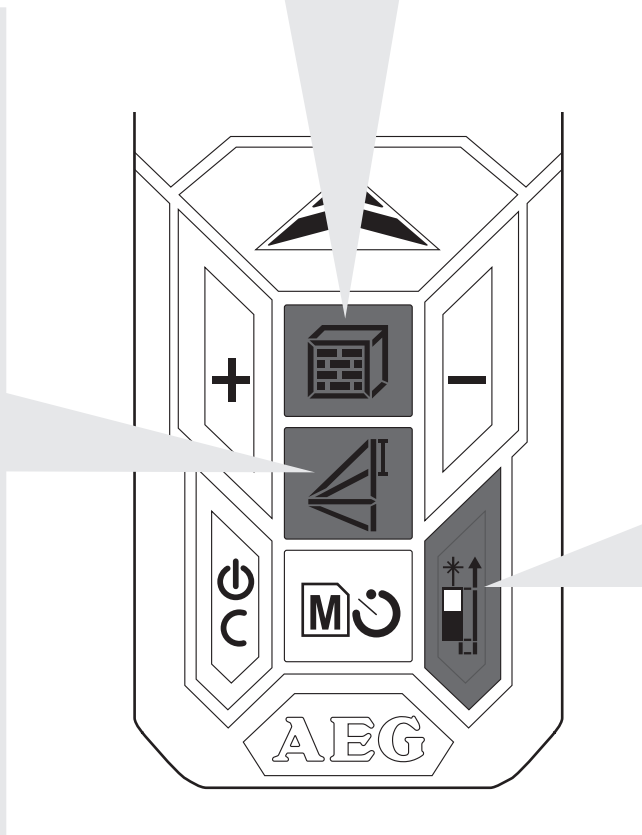
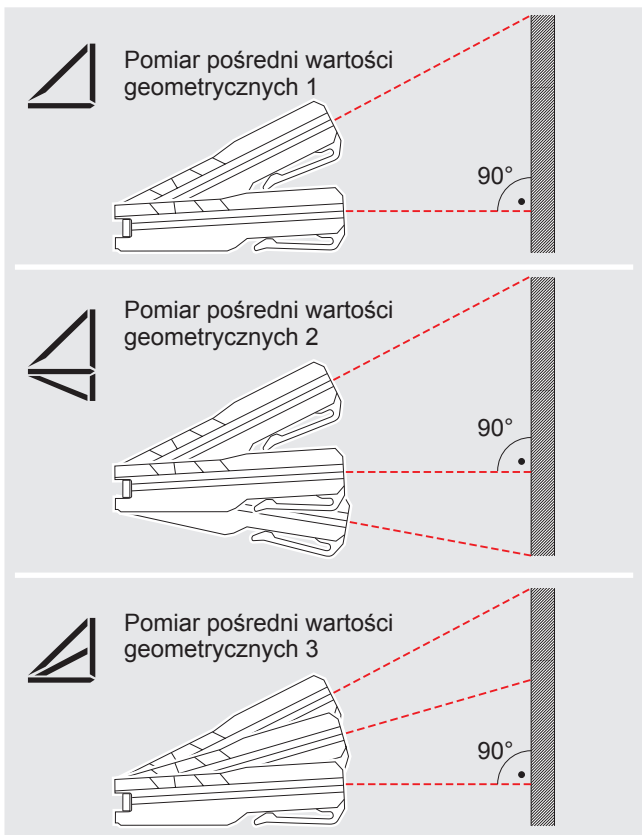
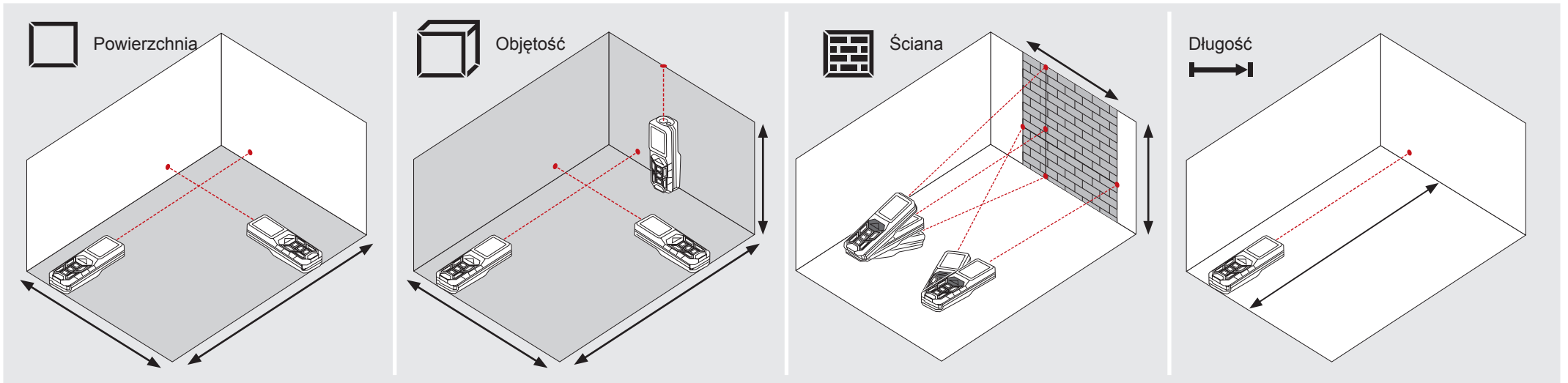

ZWYKŁY POMIAR DŁUGOŚCI

0

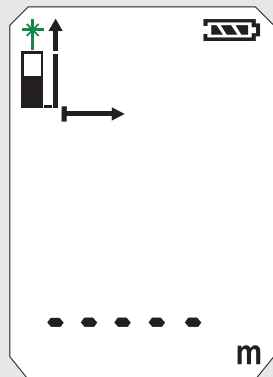

1

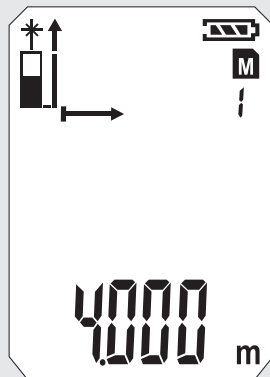
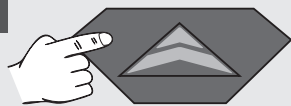

2

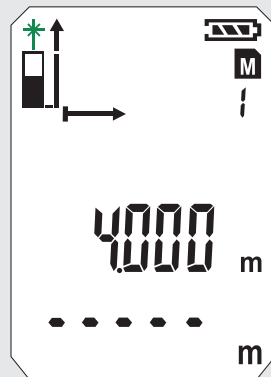
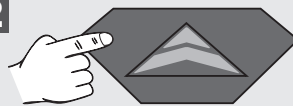

3

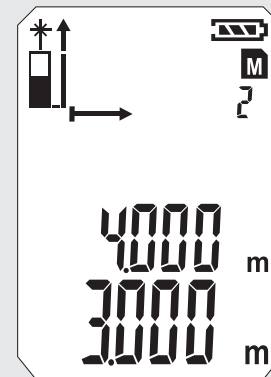
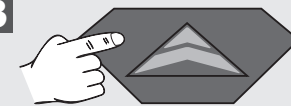

4

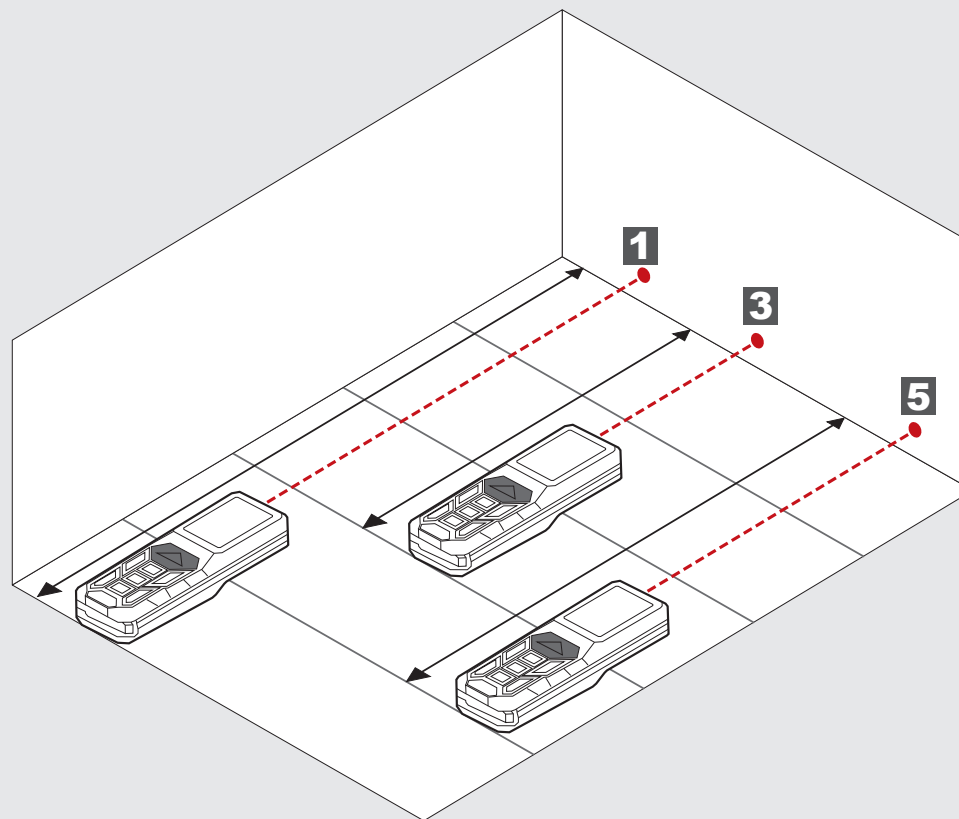
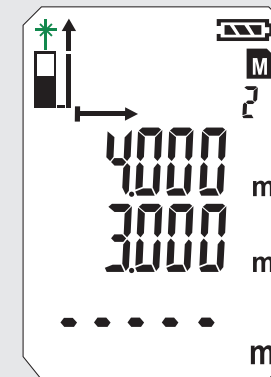
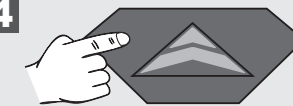

5

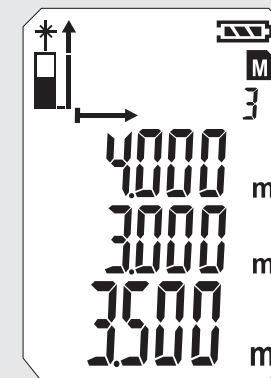
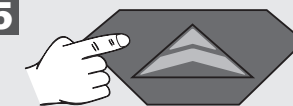

POMIAR CIĄGŁY / POMIAR MINIMUM-MAKSYMUM

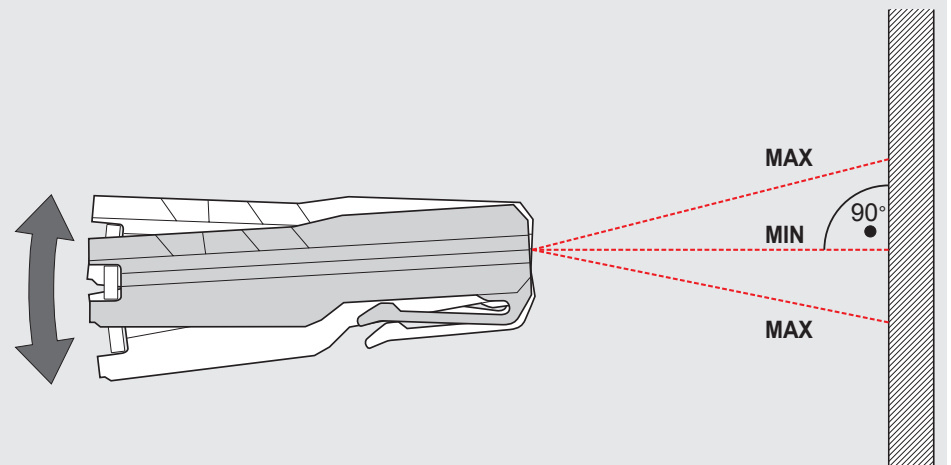
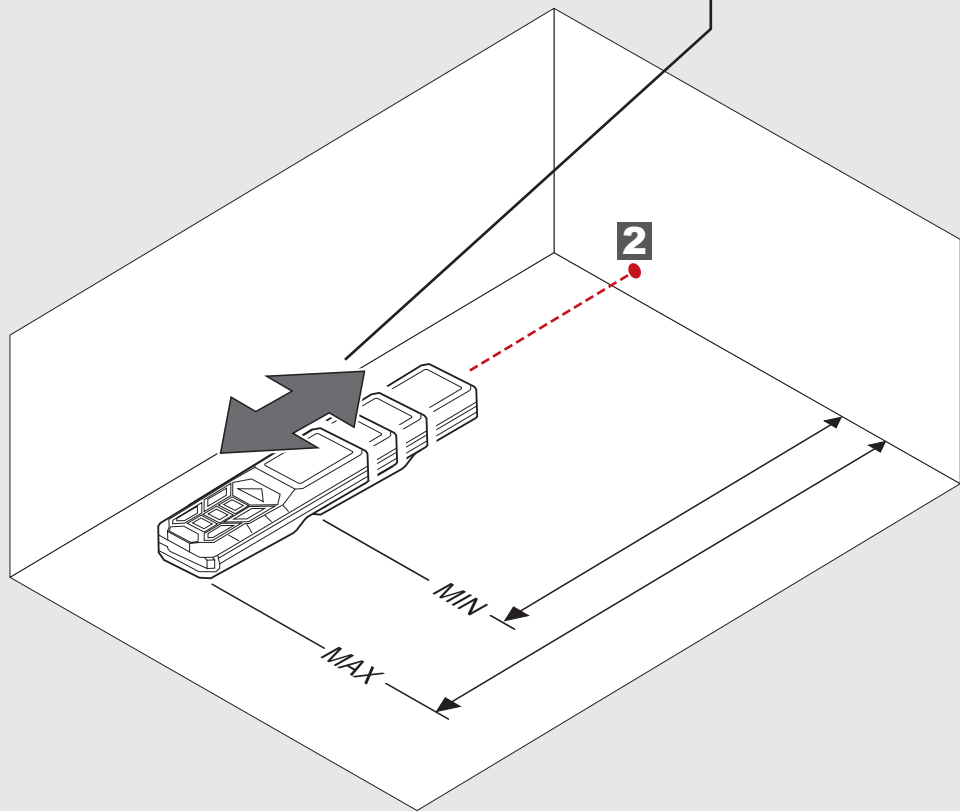
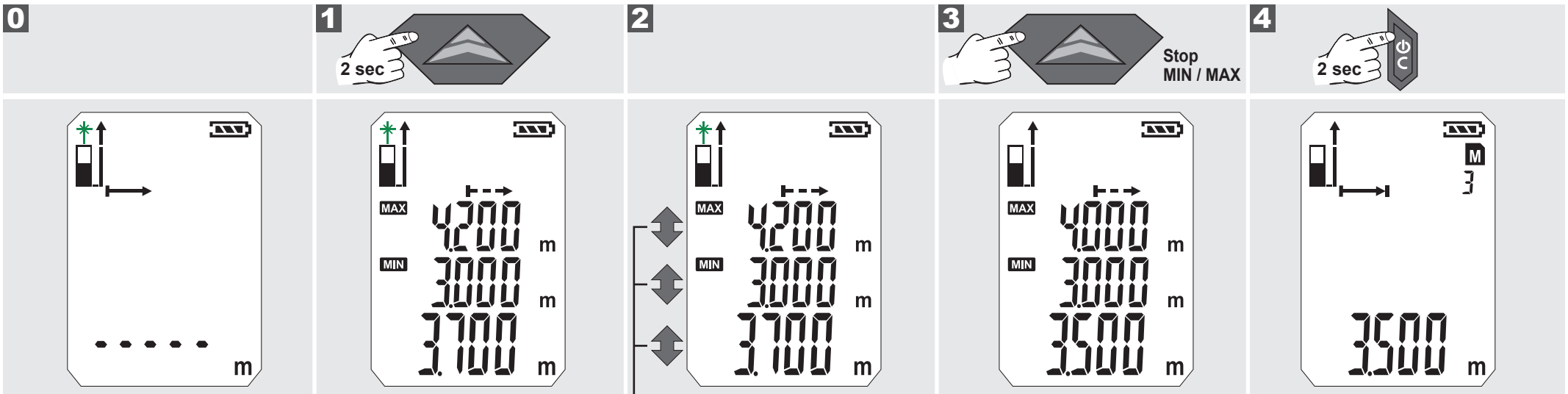

0

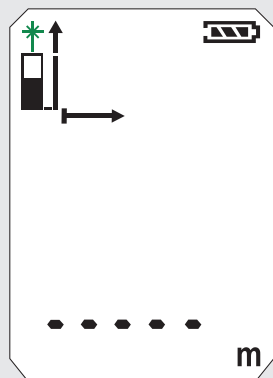

1

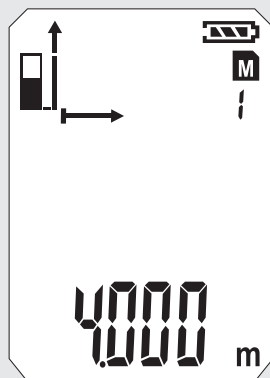
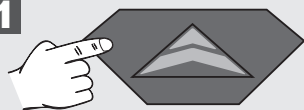

2

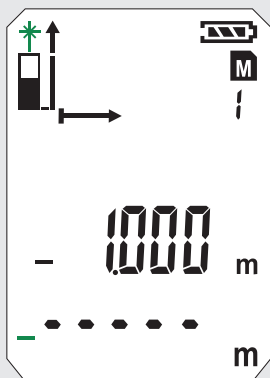
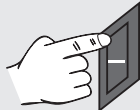

3

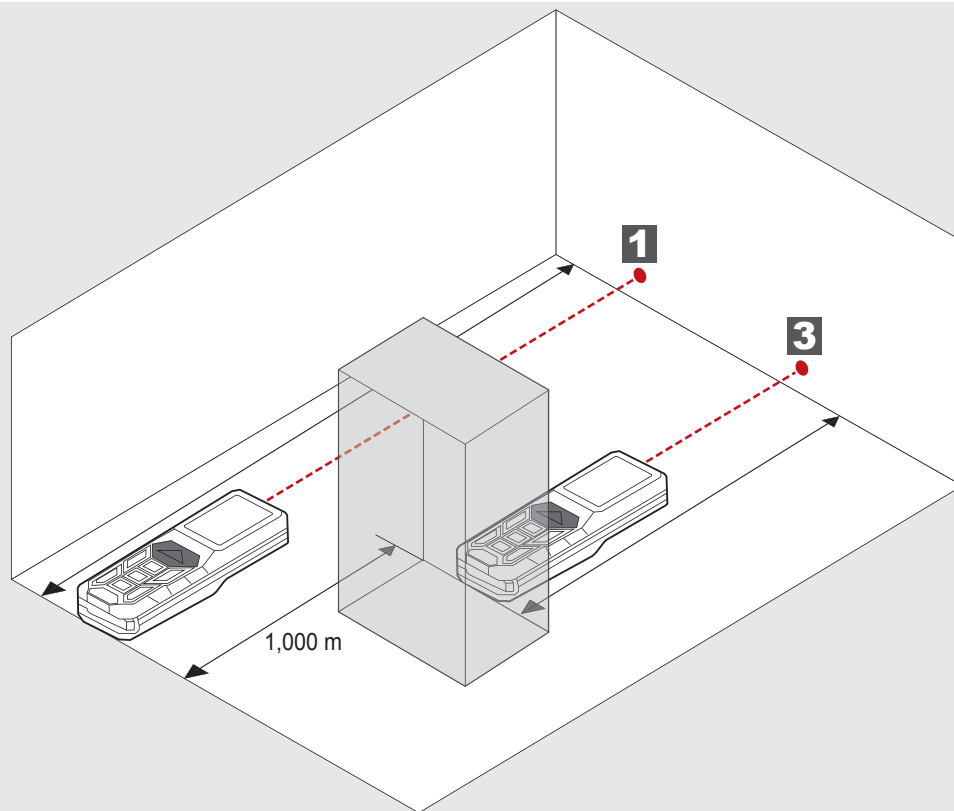
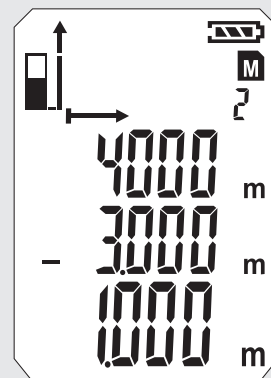
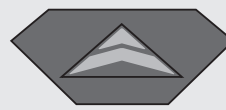

0



1

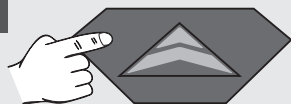

2

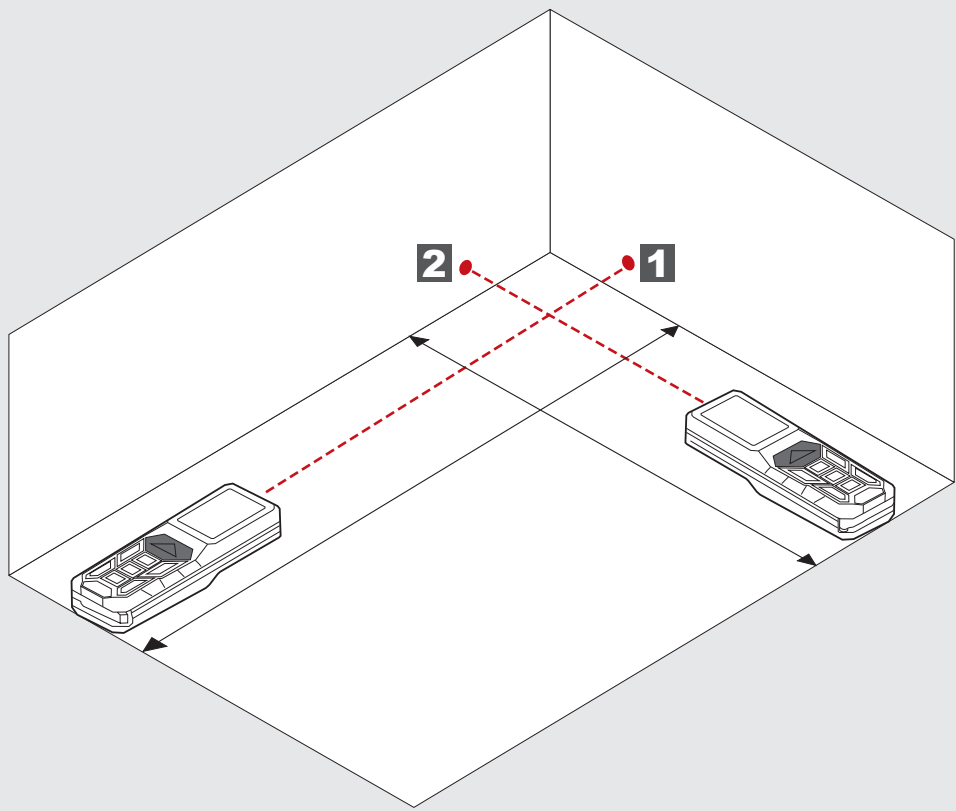
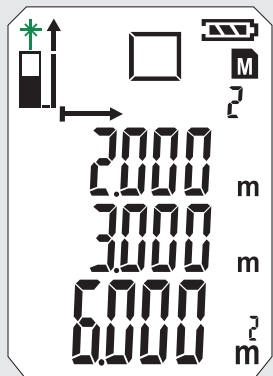
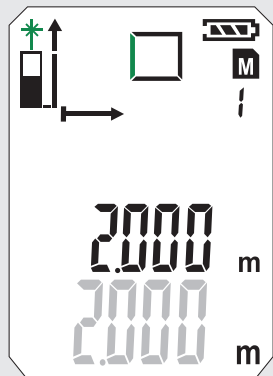
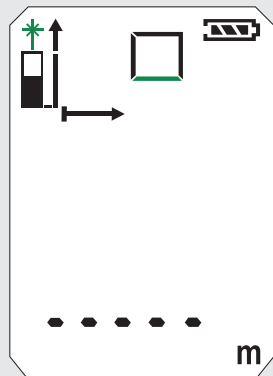
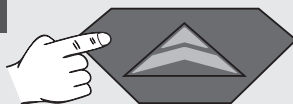

0



1

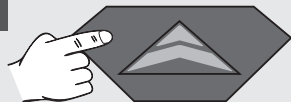

2

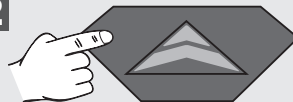

3

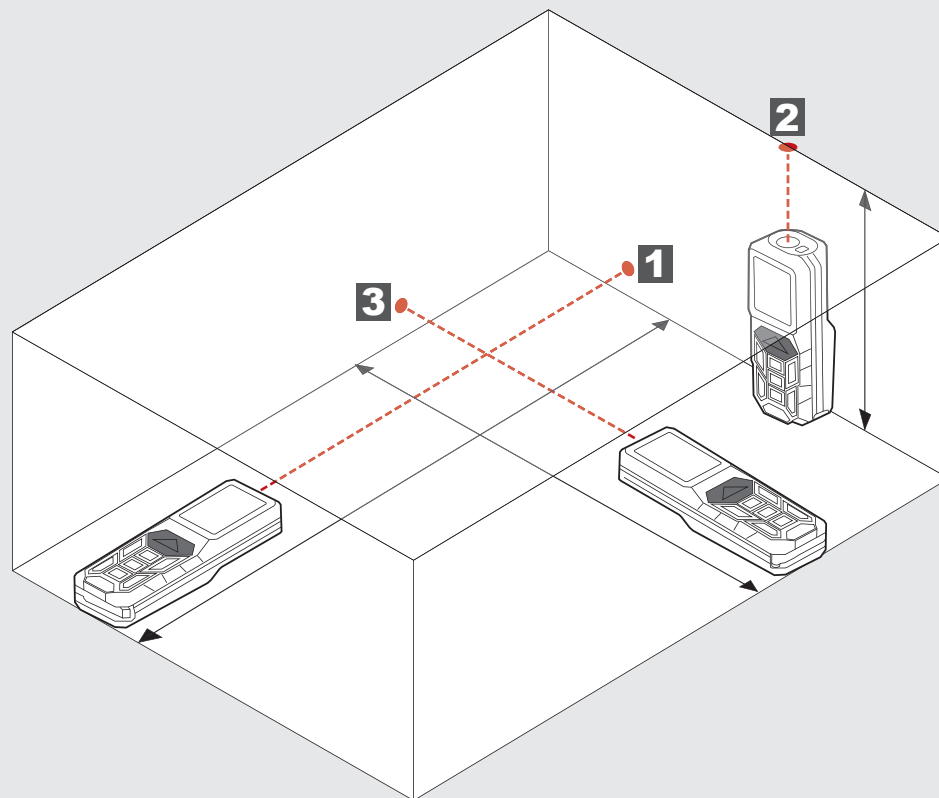
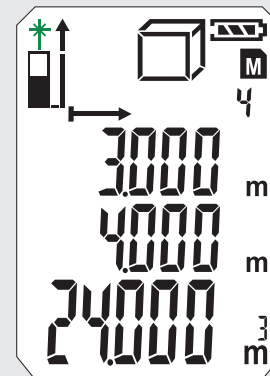
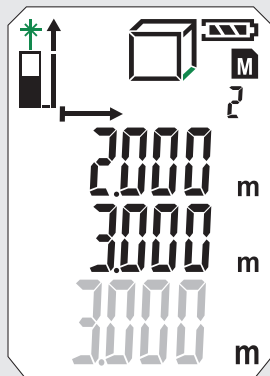
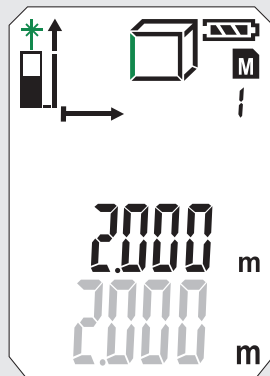
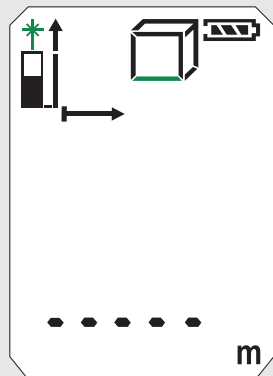
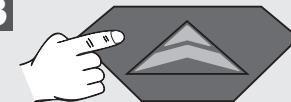

POMIAR POŚREDNI (WARTOŚCI GEOMETRYCZNYCH 1)

0



1

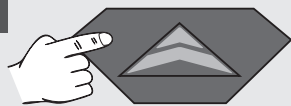

2

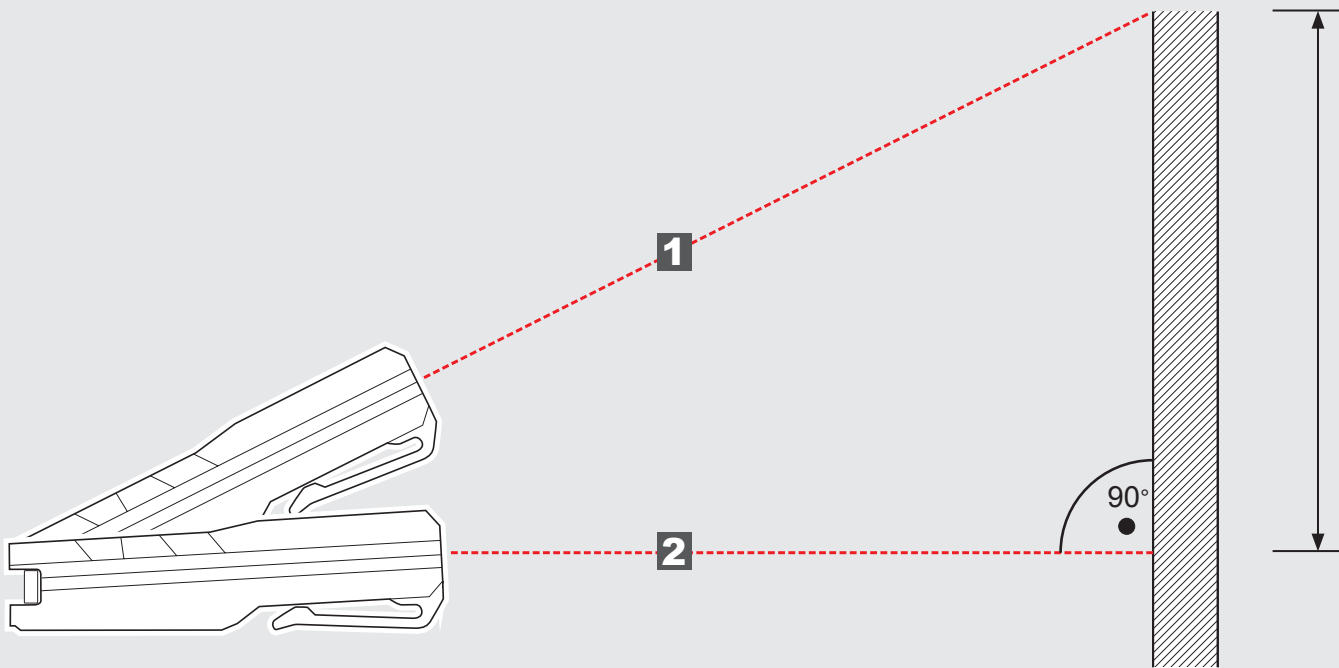
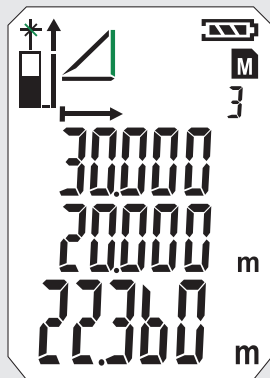
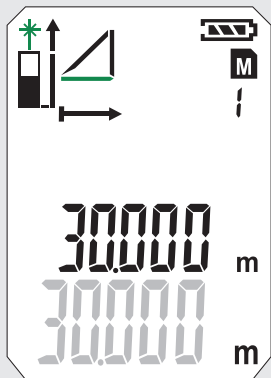
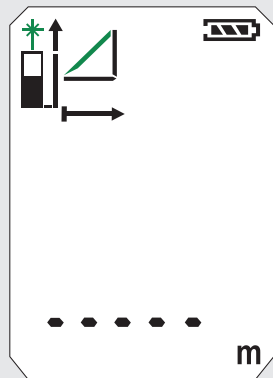
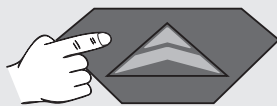

0



1

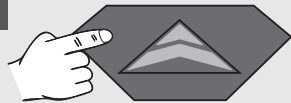

2

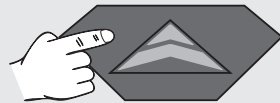

3

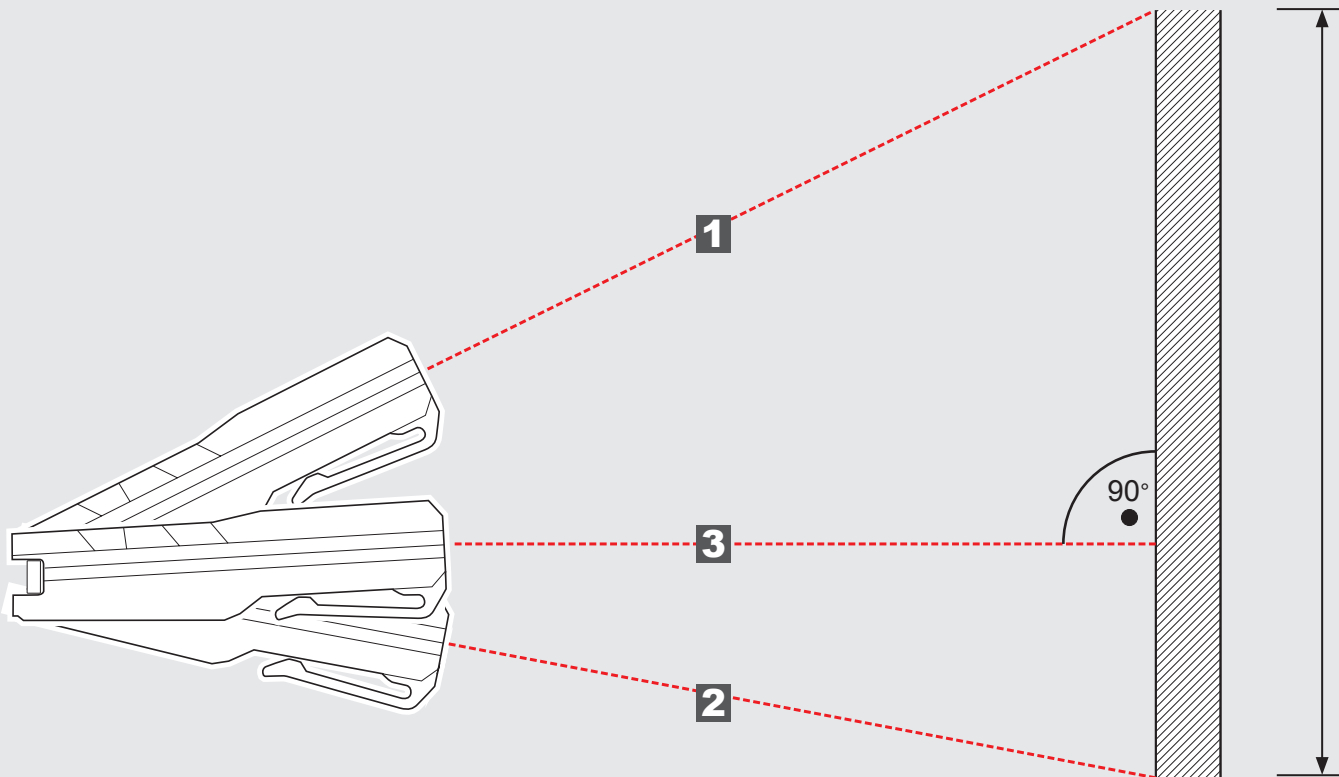
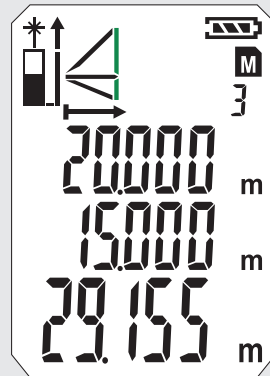
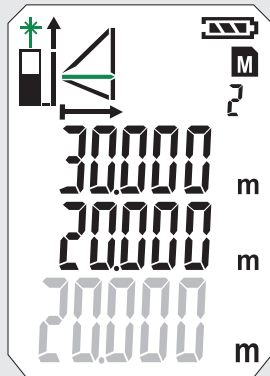
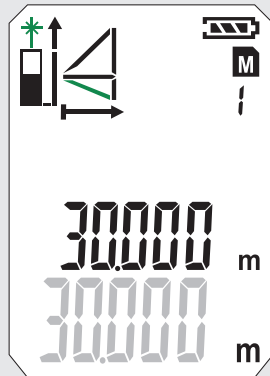
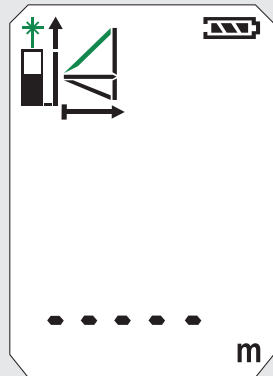
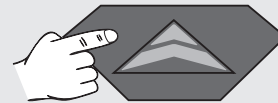

POMIAR POŚREDNI (WARTOŚCI GEOMETRYCZNYCH 3)

1

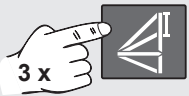

2

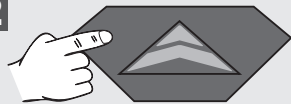



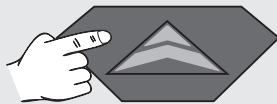

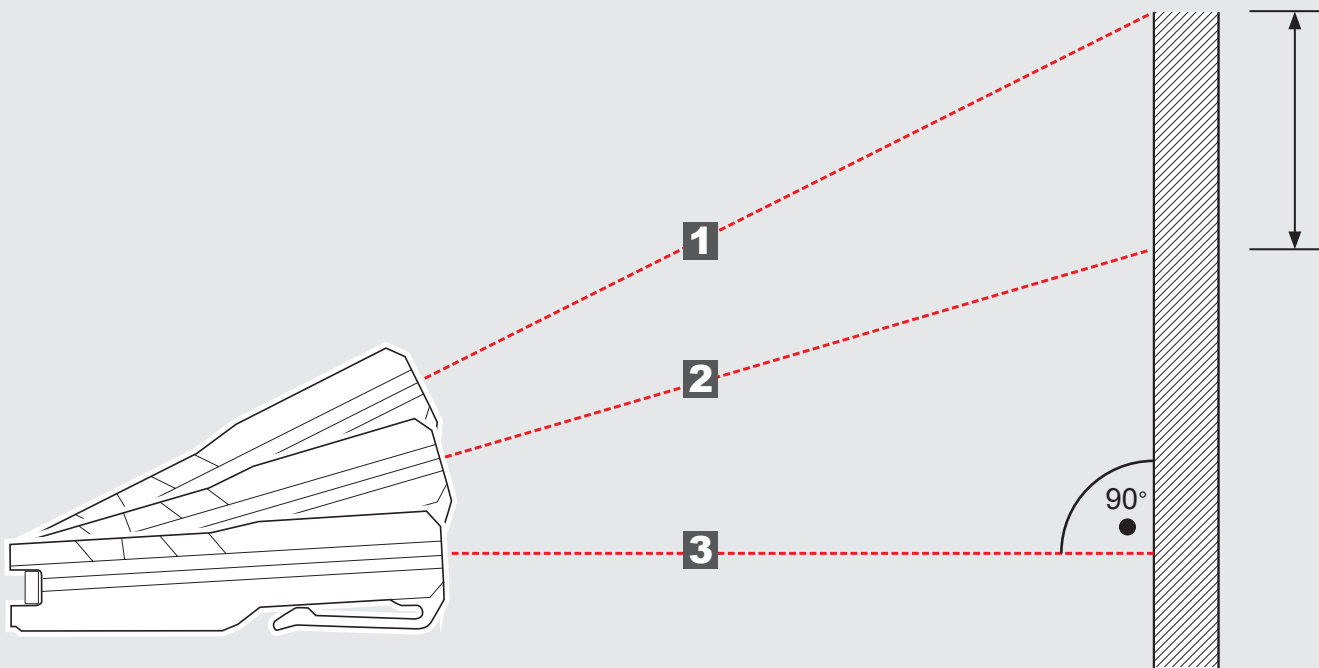
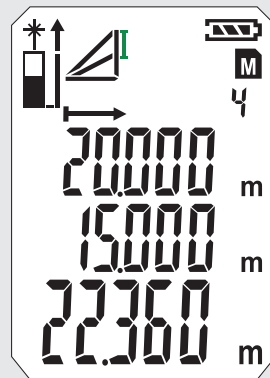
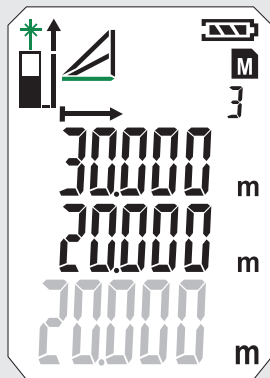
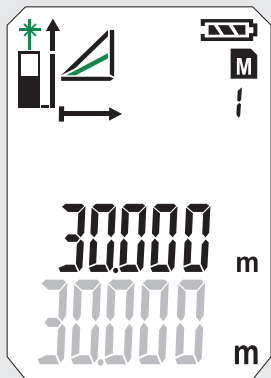
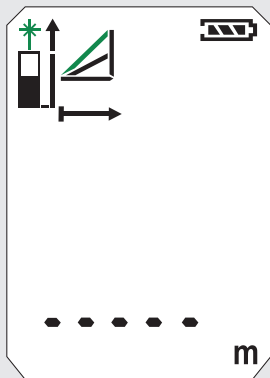
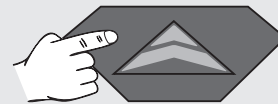

3



4

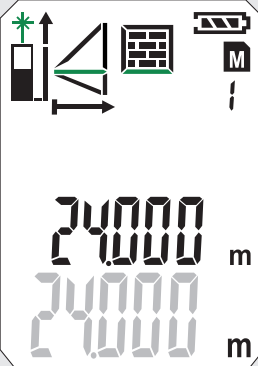
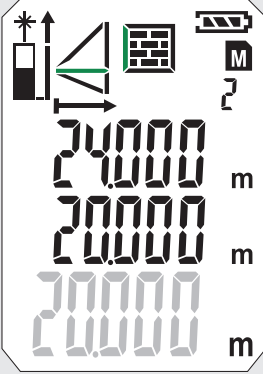
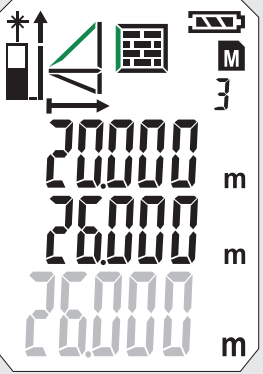
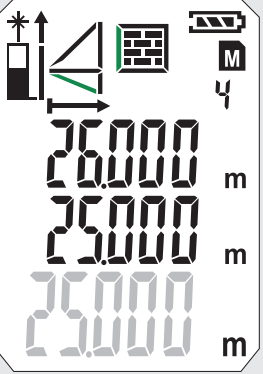

POMIAR POWIERZCHNI ŚCIANY (SCENARIUSZ 1)

0 	1 	2 	3 	4 
				

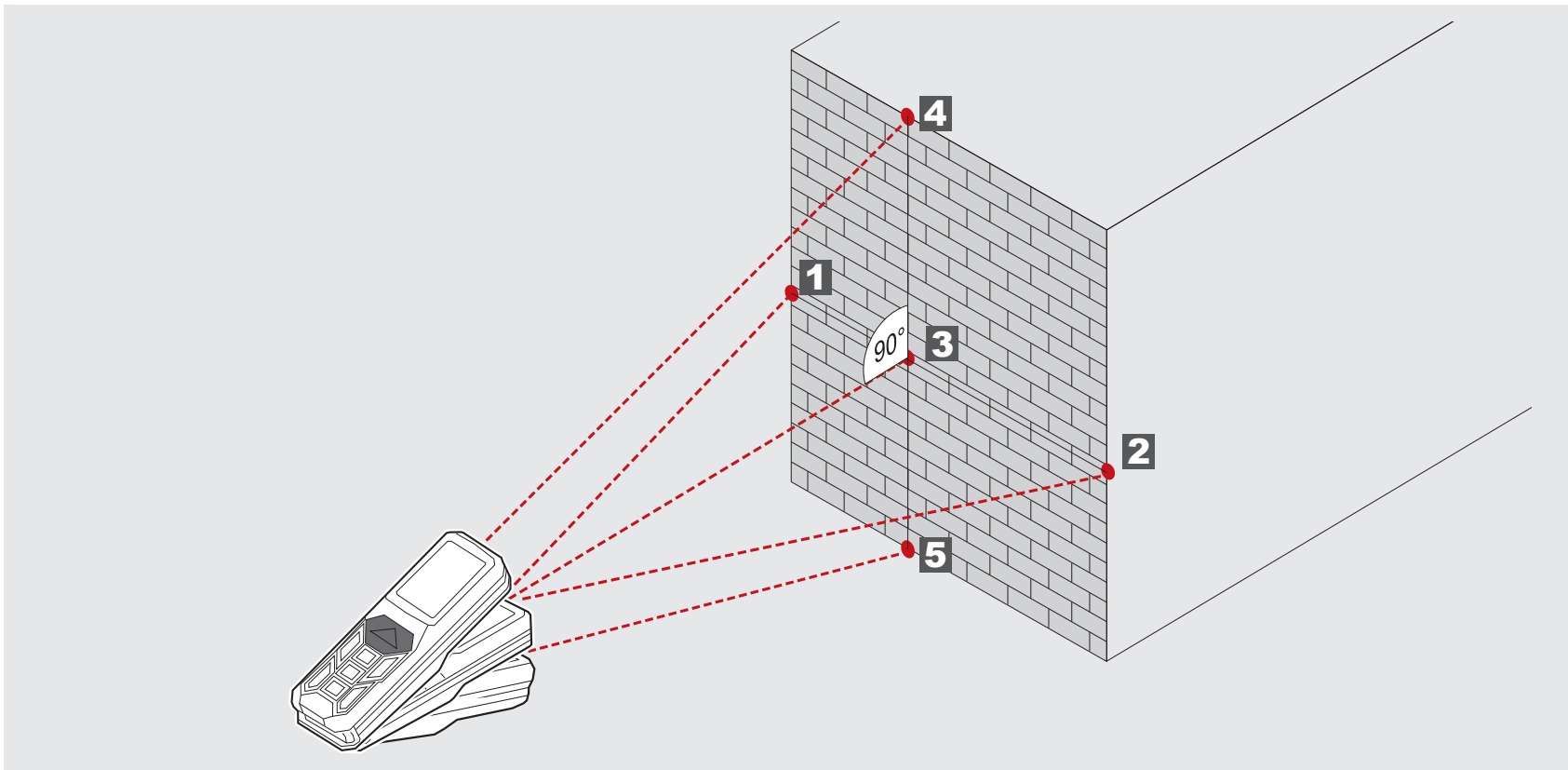





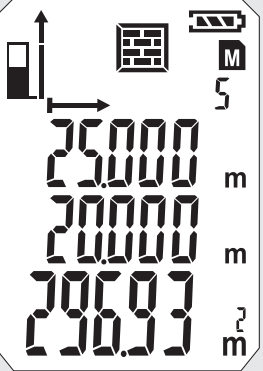

5



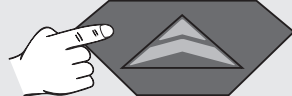
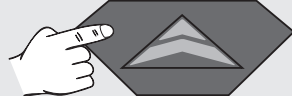

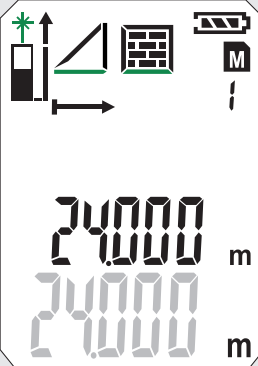
POMIAR POWIERZCHNI ŚCIANY (SCENARIUSZ 2)

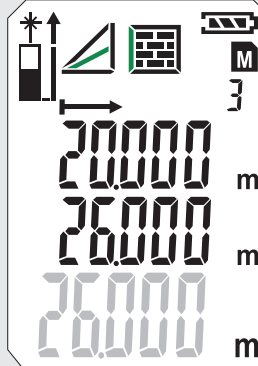
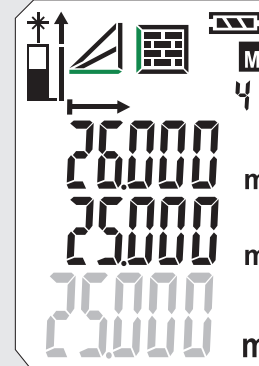
0 	1 	2 	3 	4 
				

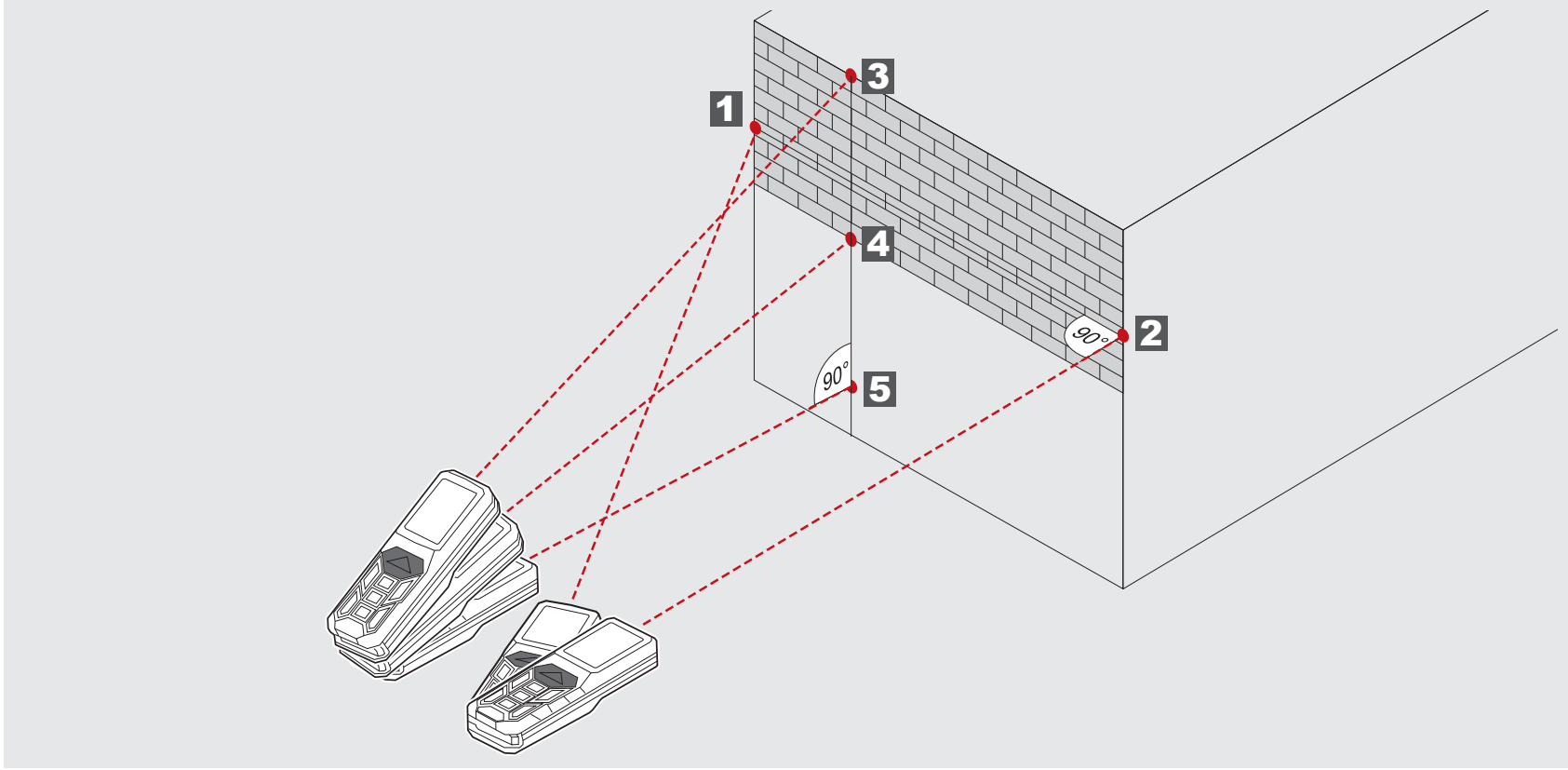

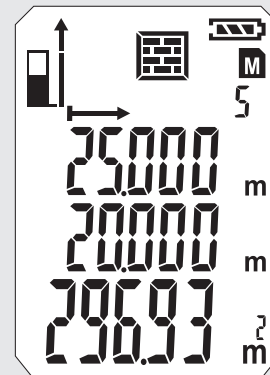

5 

ZEGAR STERUJĄCY

Za pomocą zegara sterującego można uruchomić pomiar z opóźnieniem np. aby ustawić element w promieniu pomiarowym.

Nacisnąć przycisk 

- Pojawia się symbol  Po naciśnięciu przycisku  można ustawić zegar sterujący pomiędzy 3 i 15 sek.

Nacisnąć przycisk 

- Liczone są sekundy do rozpoczęcia pomiaru.
- W przypadku 0 pomiar jest uruchamiany natychmiast.

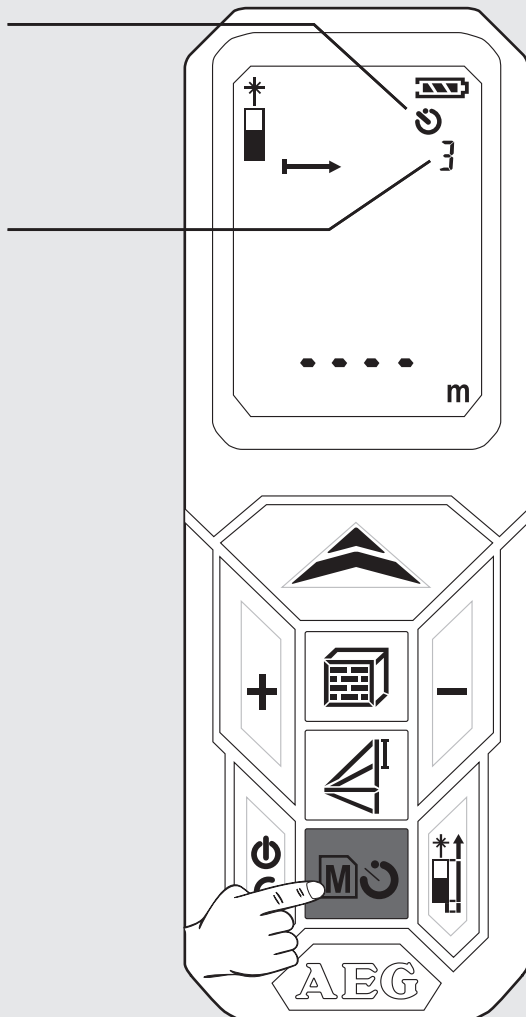

PAMIĘĆ

Wartości pomiarowe są zapisywane automatycznie w pamięci na bieżąco.

Zapisane wartości można wywołać za pomocą przycisku .

Nacisnąć przycisk  przez 2 sek.

- Pojawia się symbol i miejsce w pamięci.
- Wyświetlana jest przynależna wartość pomiarowa.
- Zapisana wartość wyświetlana jest w wierszu głównym
- Przewijają za pomocą przycisków +/-

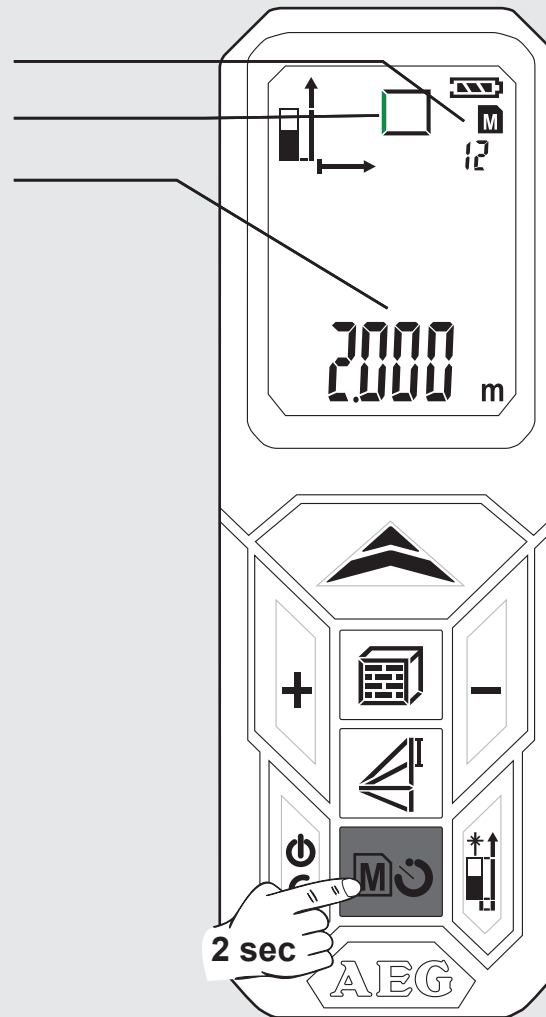

ZASADNICZY SPOSÓB DZIAŁANIA NA PRZYKŁADZIE POMIARU POWIERZCHNI (1)



1 Włączyć

Nacisnąć przycisk 

⚠ Uwaga! Włączony promień lasera!
Nie kierować na osoby!

2 Wybrać płaszczyznę pomiaru

Ustawienie standardowe po włączeniu: tył

 Nacisnąć 1x -> Kołek kątowy
 Nacisnąć 2x -> przód
 Nacisnąć 3x -> tył

3 Wybrać funkcję

Po włączeniu przyrząd zawsze ustawiony jest na pomiar długości.
Nacisnąć 1 x  - Pomiar powierzchni

4 Pomiar długości

Ustawić przyrząd i nacisnąć przycisk 

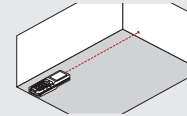

5 Pomiar szerokości

Ustawić przyrząd i nacisnąć przycisk 

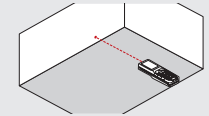

Miga symbol lasera (miganie wyświetlane jest na zielono).

Wyświetlony zostanie symbol

- Pojawia się symbol
- Wielkość mierzona miga (miganie wyświetlane jest na zielono)

- Wartość mierzona pojawia się na chwilę w wierszu głównym.
- Po upływie 1 sek. wartość mierzona przeskakuje do wiersza położonego wyżej.

- Wartość mierzona pojawia się na chwilę w wierszu głównym.
- Po upływie 1 sek. wartość mierzona przeskakuje do wiersza położonego wyżej.

Wartość mierzona zapisana zostaje do pamięci pod kolejnym numerem.
Miga druga wartość mierzona.
Przyrząd jest gotowy do pomiaru drugiej wartości.

Wartość mierzona zostaje zapisana w pamięci pod kolejnym numerem.
- Wynik zostaje wyświetlony w wierszu głównym i zapisany w pamięci pod kolejnym numerem.

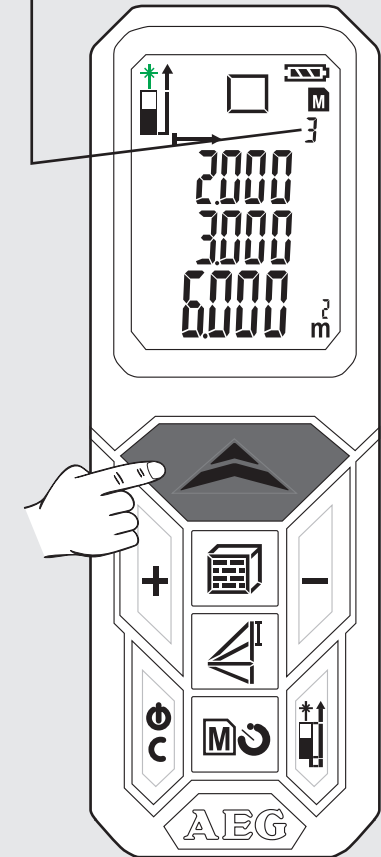
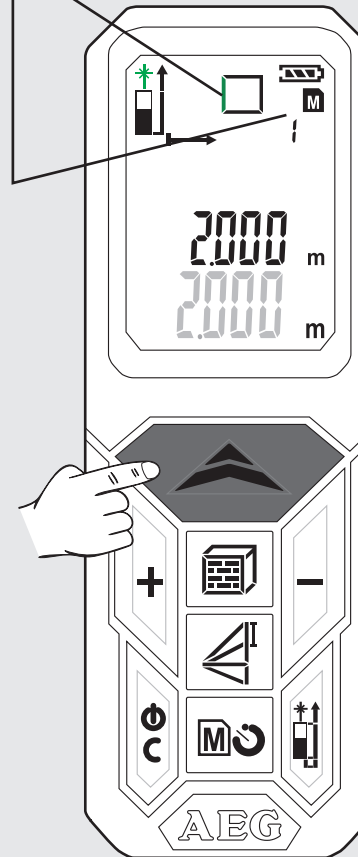
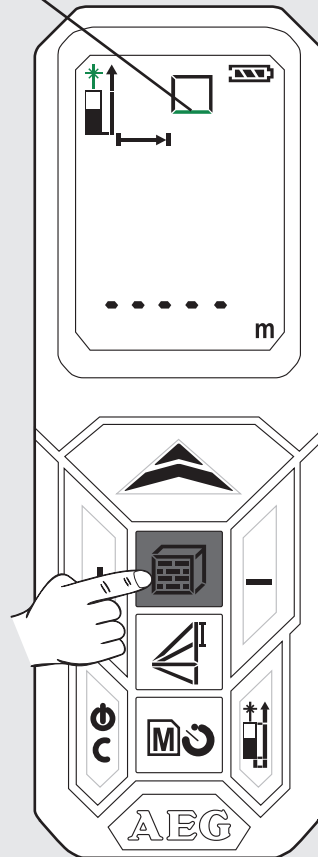
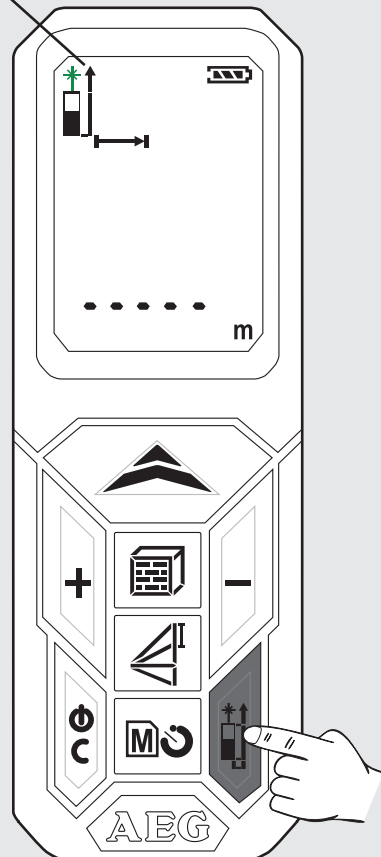
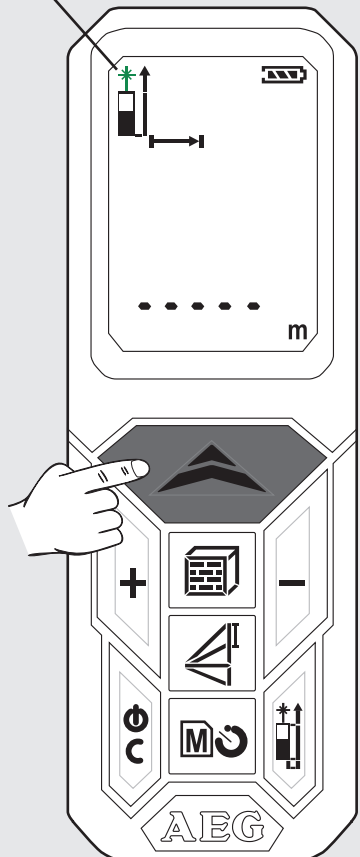

ZASADNICZY SPOSÓB DZIAŁANIA NA PRZYKŁADZIE POMIARU POWIERZCHNI (2)

6 Wywołanie wartości zapisanych w pamięci

Nacisnąć przycisk  przez 2 sek.

Nacisnąć przycisk + lub -

- Wartości zapisane w pamięci wyświetlone zostaną w wierszu głównym.
- Wyświetlony zostaje przynależny symbol a wartość mierzona miga (miganie wyświetlane jest na zielono).

7 Wyjście z pamięci

Nacisnąć przycisk 

8 Wyłączenie

Nacisnąć przycisk  przez 2 sek.
(Należy uprzednio wyjść z pamięci).

- Przyrząd się wyłącza.
- W przypadku gdy w ciągu 3 minut nie zostanie naciśnięty żaden przycisk przyrząd wyłączy się automatycznie.

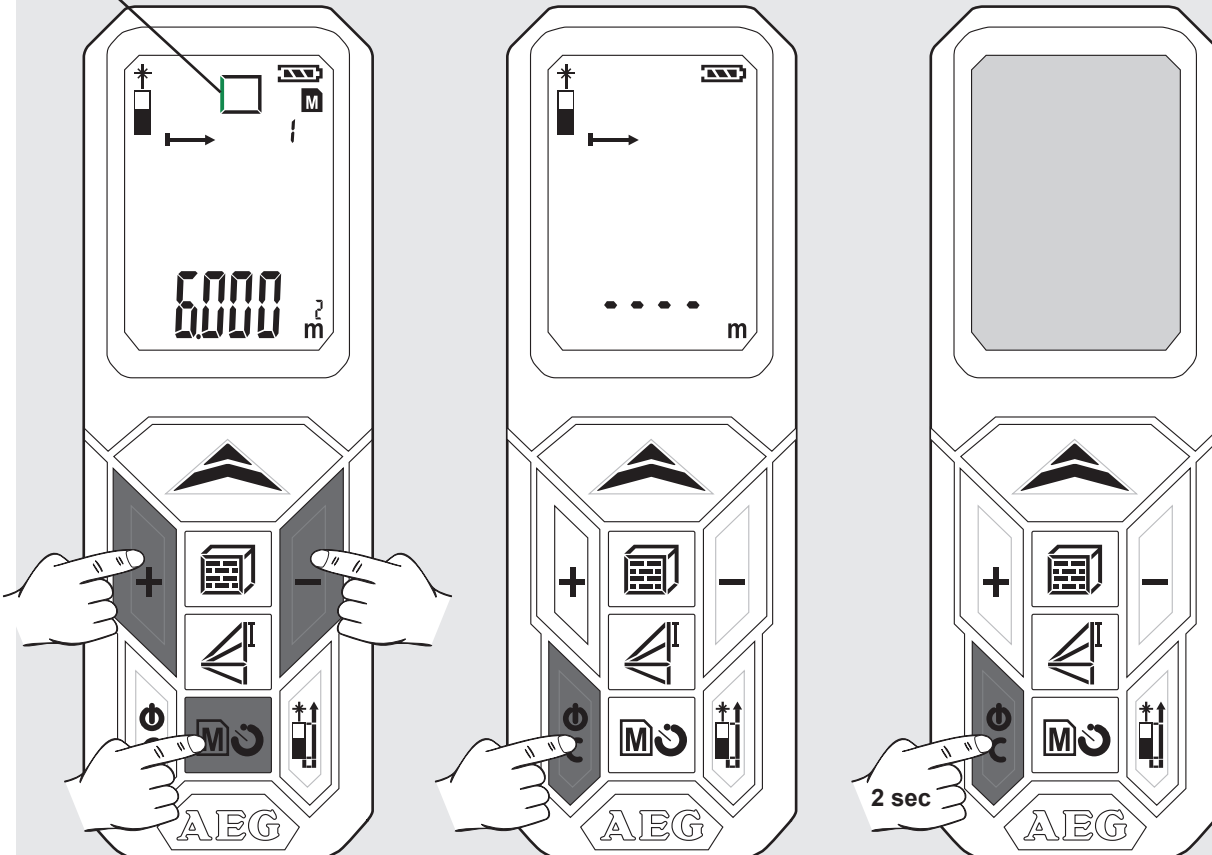

TARTALOM

Fontos biztonsági előírások.....	1
Műszaki adatok.....	2
Rendeltetésszerű használat	2
Hibakód táblázat.....	2
Áttekintés.....	3
Elemcsere.....	4
Sarok stift.....	4
Övcsipesz.....	4
Funkciógomb, Pitagorasz, mérési sík.....	5
Egyszerű hossz mérés	6
Folyamatos mérés/ Minimum-Maximum mérés.....	7
Összeadó / kivonó mérés	8
Felületmérés.....	9
Térfogatmérés	10
Indirekt mérés (Pitagorasz 1)	11
Indirekt mérés (Pitagorasz 2)	12
Indirekt mérés (Pitagorasz 3)	13
Falfelület mérése (1. forgatókönyv).....	14
Falfelület mérése (2. forgatókönyv).....	15
Időzítő.....	16
Memória.....	16
Alapvető működésmód felületmérés példáján (1)	17
Alapvető működésmód felületmérés példáján (2)	18

FONTOS BIZTONSÁGI ELŐÍRÁSOK



A termék használata előtt tanulmányozza a mellékelt CD-n található Biztonsági előírásokat és Használati útmutatót.

Lézer osztályozás

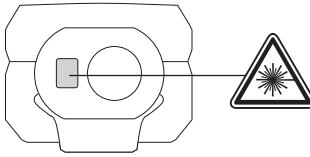

FIGYELMEZTETÉS:

Ez a **2. lézerosztályú** termék megfelel az IEC 60825-1:2007 előírásainak.



Feliratozás

Ragassza az első üzembehelyezés előtt az anyanyelvén mellékelt matricát a teljesítménytáblán lévő angol nyelvű szövegre.

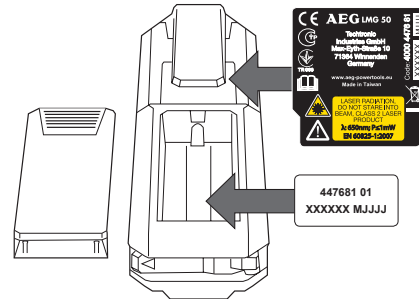

Figyelmeztetés:

Ne nézzen közvetlenül a lézersugárba. A lézersugár rövid időre vakságot okozhat.

Ne nézzen a lézersugárba, és ne irányítsa feleslegesen mások felé.

Ne vakítson el vele másokat.

Figyelmeztetés:

A lézeres eszközt ne használják gyermekek közelében, és nem szabad gyermekeknek megengedni a használatát.

Figyelem! Visszaverő felületekről visszaverődhet a lézersugár a kezelőre vagy más személyekre.

Tartson biztonságos távolságot a forgó részekről.

Végezzen időnként ellenőrző méréseket, különösen fontos mérések előtt, alatt és után.

Ha a műszert leejtették, nem megfelelően használták vagy átalakították, hibás mérés történhet.

Figyelem! Ismerkedjen meg a kezelőelemekkel és a kerti kispég előírászerű használatával.

A lézeres mérőműszer alkalmazási területe korlátozott. (Lásd a „Műszaki adatok” c. részt). A maximális és minimális tartományon kívül megkísérelt mérések pontatlanságokat okoznak. Ha a készüléket szélsőséges körülmények között, pl. túl nagy forróság, hideg, nagyon erős napsugárzás, eső, hó, köd vagy más látást korlátozó körülmények esetén használják, akkor a mérések pontatlanok lehetnek.

Ha lézeres mérőműszert meleg környezetből hidegre viszik (vagy fordítva), akkor meg kell várni, hogy a készülék alkalmazkodjon az új környezeti hőmérsékletre.

A lézeres mérőműszert olyan helyen kell tárolni, amely megvédi az eszközt a rázkódásoktól, vibrációktól vagy szélsőséges hőmérsékletektől.

A lézeres mérőműszert védeni kell portól, nedvességtől és magas páratartalomtól. Az ilyen körülmények tönkreteszhetik a belső alkatrészeket, vagy befolyásolhatják a pontosságot.

Ne használjon agresszív tisztítószerkeket vagy oldószereket. A tisztítást csak tiszta, puha kendővel végezze.

Kerülje a lézeres mérőműszert érő erős ütéseket, vagy az eszöz leesését. Ellenőrizni kell az eszköz pontosságát, ha az leesett vagy más mechanikus terheléseknek volt kitéve.

A lézeres eszközön szükséges javításokat csak felhatalmazott szakember végezhet.

A terméket tilos robbanásveszélyes vagy agresszív környezetben használni.

Az akkumulátorok töltéséhez kizárólag a gyártó által ajánlott töltőt használjon.

 A lemerült elemeket nem szabad a háztartási hulladékkal együtt ártalmatlanítani. Az elhasznált elemeket környezetkímélő ártalmatlanítás céljából a nemzeti vagy helyi előírások szerint az arra kijelölt gyűjtőhelyeken kell leadni. A készüléket nem szabad a háztartási hulladékkal együtt ártalmatlanítani. A készülék ártalmatlanítását szakszerűen kell végezni. Be kell tartani az ártalmatlanításra vonatkozó országspecifikus előírásokat. Az ártalmatlanításra vonatkozó információkért forduljon a helyi hatósághoz vagy kereskedőjéhez.

 CE-jelölés

MŰSZAKI ADATOK

Védelmi osztály	IP54 (por és fröccsenő víz ellen védett)
Optika	14 mm
Gyújtópont	35 mm
Mérési tartomány max.	50 méter (tűrés: 55m)
Mérési tartomány min.	0,05 méter
Abszolút pontosság @ < 10m	± 1,5 mm (max.)
Ismétlési pontosság @ < 10m	± 1,5 mm (tipikusan max. 2σ)
Ismétlési pontosság @ > 10m	emelkedés ± 0,25 mm / méter (tipikusan max. 2σ)
Mérési idő	0,5 mp
Kijelző típusa	LCD (22,7 mm x 31 mm)
Áramellátás	AAA 2x (alkáli elem)
Elemek élettartama	10000 (egyes mérés)
Lézer kimeneti teljesítménye	0,6 mW ~ 0,95 mW (2-es osztály, 650 nm)
Lézer pontméret	25 x 30 mm @ 16 m (max.)
Lézersugár függőleges szög	+1 fok
Lézersugár vízszintes szög	±1 fok
A készülék automatikus lekapcsolása	180 másodperc
A lézersugár automatikus lekapcsolása	30 másodperc
Üzemi hőmérséklet	-10°C-tól +50°C-ig
Tárolási hőmérséklet	-25°C-tól +70°C-ig
Súly elemek nélkül	80 g

RENDELTETÉSSZERŰ HASZNÁLAT

A lézeres mérőműszer távolságok és elhajlások mérésére alkalmas.

A készüléket kizárólag az alábbiakban leírtaknak megfelelően szabad használni.

HIBAKÓD TÁBLÁZAT

Kód	Leírás	Elhárítás
Err01	Mérési tartományon kívül	A mérést az előírt tartományban kell elvégezni.
Err02	A visszavert jel túl gyenge	válasszon jobb felületet.
Err03	Érték a kijelzési tartományon kívül (max. érték: 99.999) pl. annak az eredménye, hogy a felület vagy a térfogat a kijelzési tartományon kívül van	Ellenőrizze, hogy az értékek és a lépések megfelelőek-e.
Err04	Hiba a Pitagorasz-számításban	Ellenőrizze, hogy az értékek és a lépések megfelelőek-e.
Err05	Merülő elem	Helyezzen be új elemeket.
Err06	Az üzemi hőmérsékleti tartományon kívül	Végezze el a mérést az előírt üzemi hőmérsékleti tartományban.
Err07	A környezeti fény túl erős	Sötétítse le a célterületet.

Pitagorasz
Magasságkülönbség

Mérési sík

Hosszmérés

Minimum / Maximum folyamatos méréshez

Összeadás / Kivonás

Felület / Térfogat
Indirekt felületmérés

Elem állapota

Memória

Időzítő

Folyamatos mérés

Köztes értékek

Teljes érték

BE / MÉRÉS

- ▶ Be
- ▶ Mérés
- ▶ Folyamatos mérés (2 mp-ig nyomja)
- Min. / Max. funkció

ÖSSZEADÁS

- ▶ Érték hozzáadása
- ▶ Navigálás a memóriában

FELÜLET / TÉRFOGAT

- ▶ Felület (1x nyomja meg)
- ▶ Térfogat (2x nyomja meg)
- ▶ Indirekt felületmérés (3x / 4x nyomja meg)

BEKAPCSOLÁS

- ▶ Be
- ▶ Ki (2 mp-ig nyomja)
- ▶ Törlés

KIVONÁS

- ▶ Érték kivonása
- ▶ Navigálás a memóriában

PITAGORASZ

- ▶ Pitagorasz 1 (1x nyomja meg)
- ▶ Pitagorasz 2 (2x nyomja meg)
- ▶ Pitagorasz 3 (3x nyomja meg)

MÉRÉSI SÍK VÁLTÁSA

- ▶ Elöl
- ▶ Hátsó
- ▶ Sarok stift

MEMÓRIA

- ▶ Időzítő 3-15 mp (1x nyomja meg)
- ▶ Memória 1-20 (1x 2 mp-ig nyomja)
- ▶ Navigálás a memóriában a +/- gombokkal

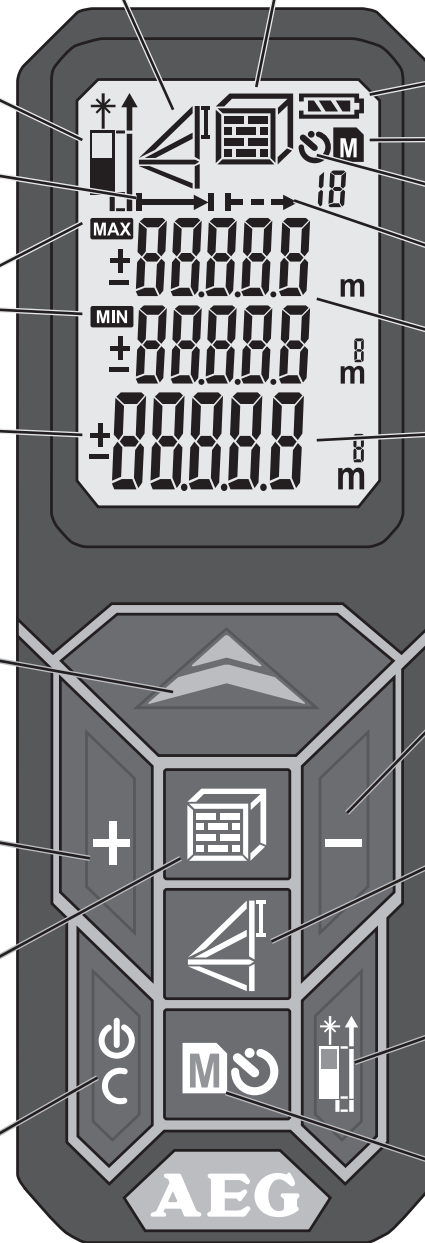

ELEMCSERE

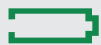
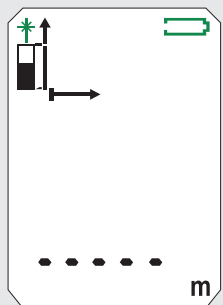

Ha a szimbólum villog, cserélje ki az elemet.

1

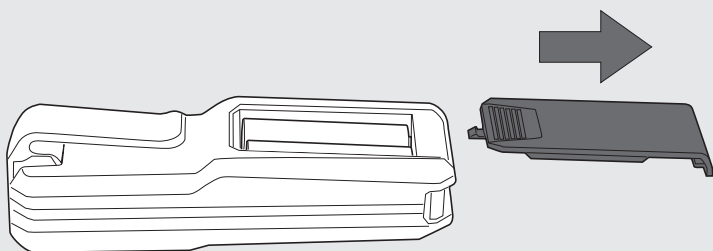

2

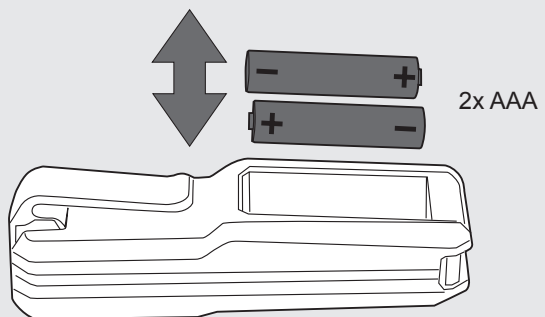

3

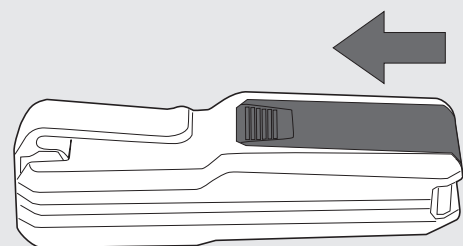

SAROK STIFT

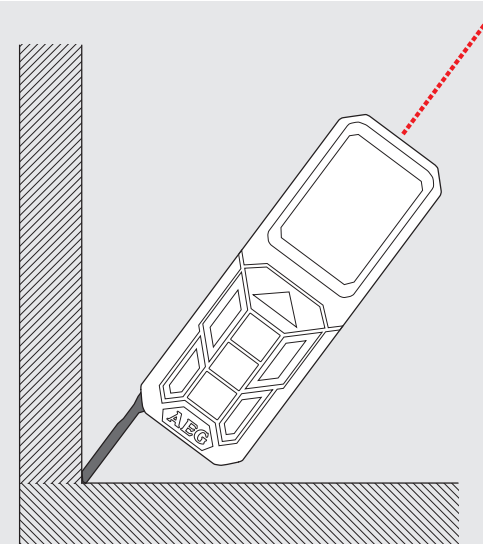
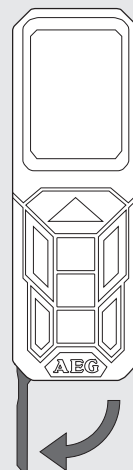

ÖVCSIPESZ

1

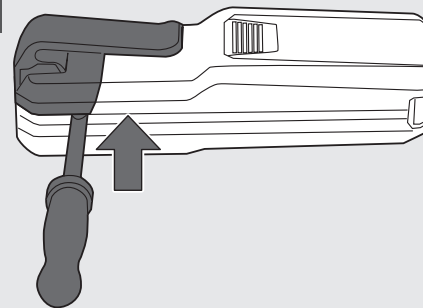

2

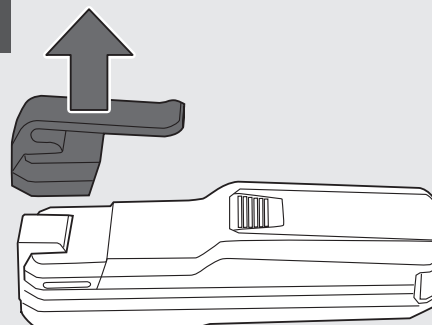

3

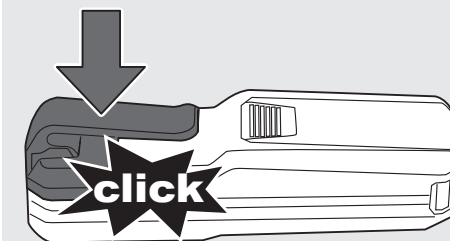

FUNKCIÓGOMB, PITAGORASZ, MÉRÉSI SÍK

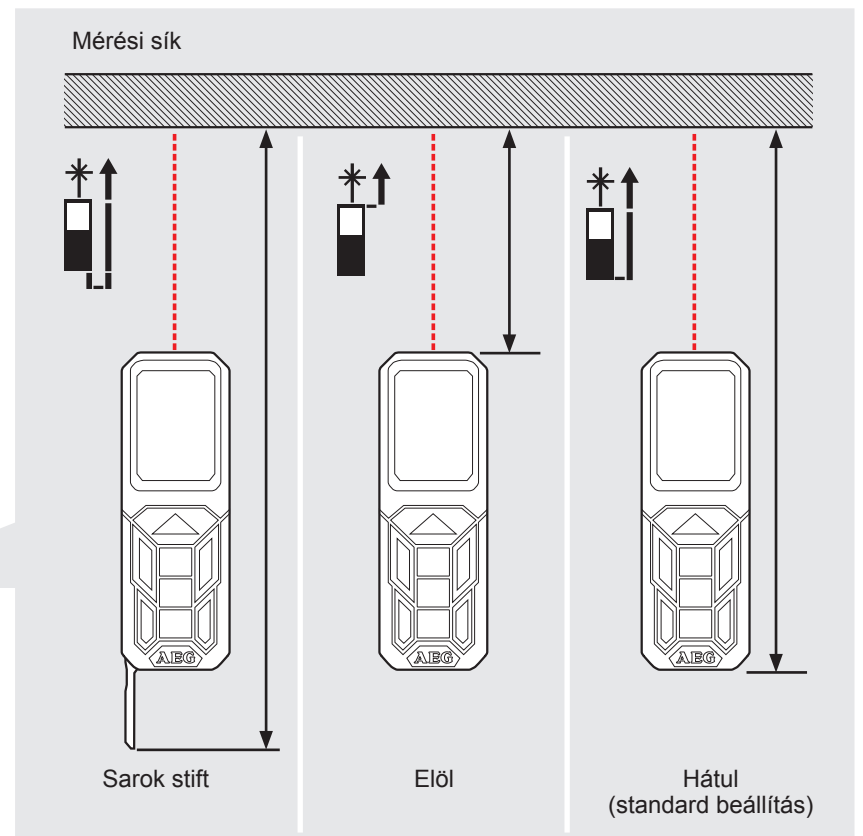
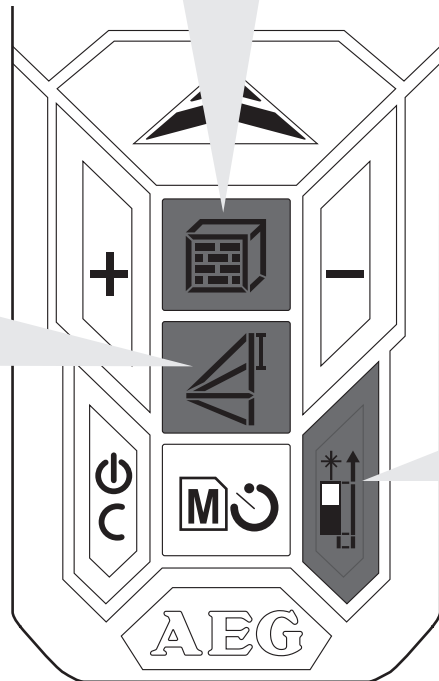
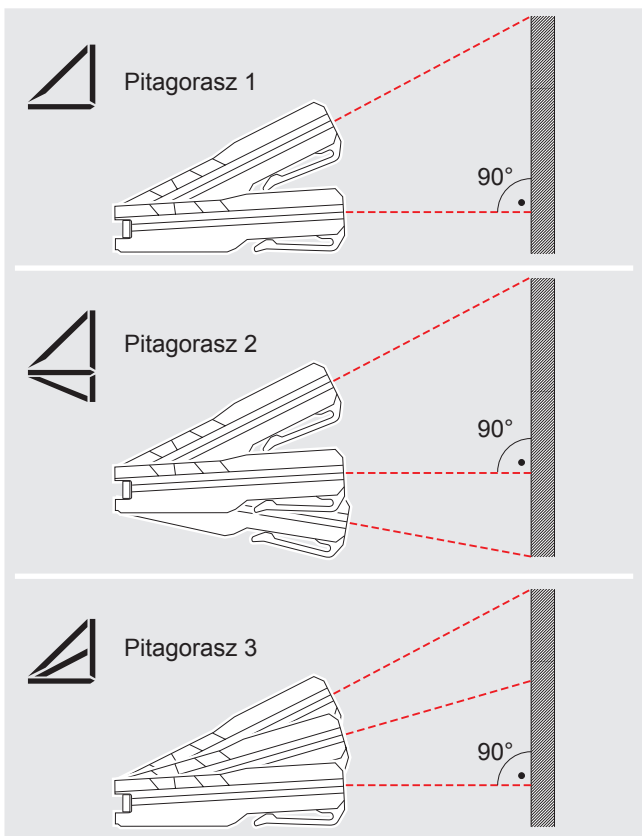
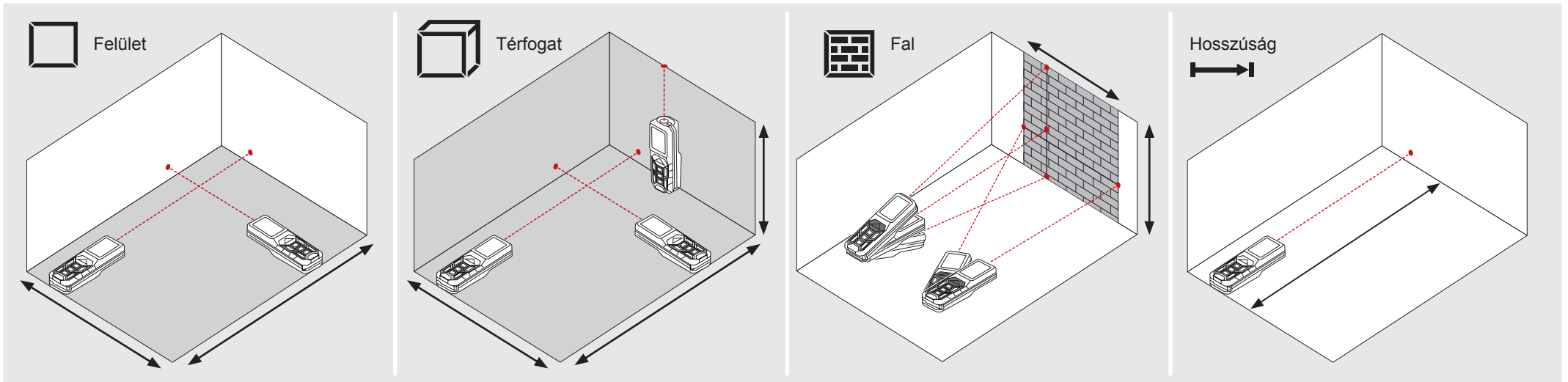

EGYSZERŰ HOSSZMÉRÉS

0

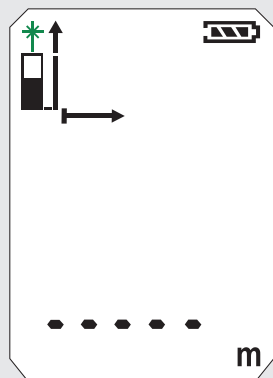

1

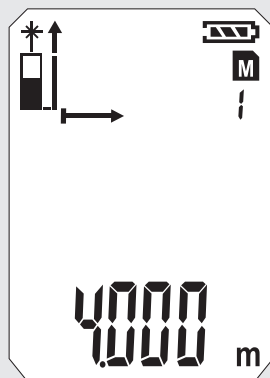
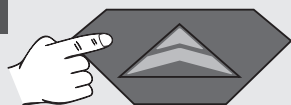

2

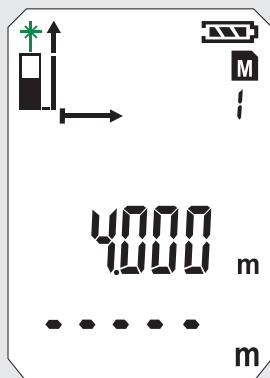
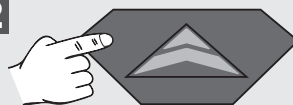

3

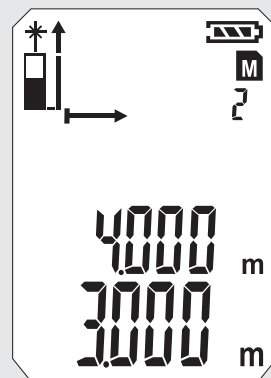
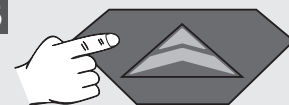

4

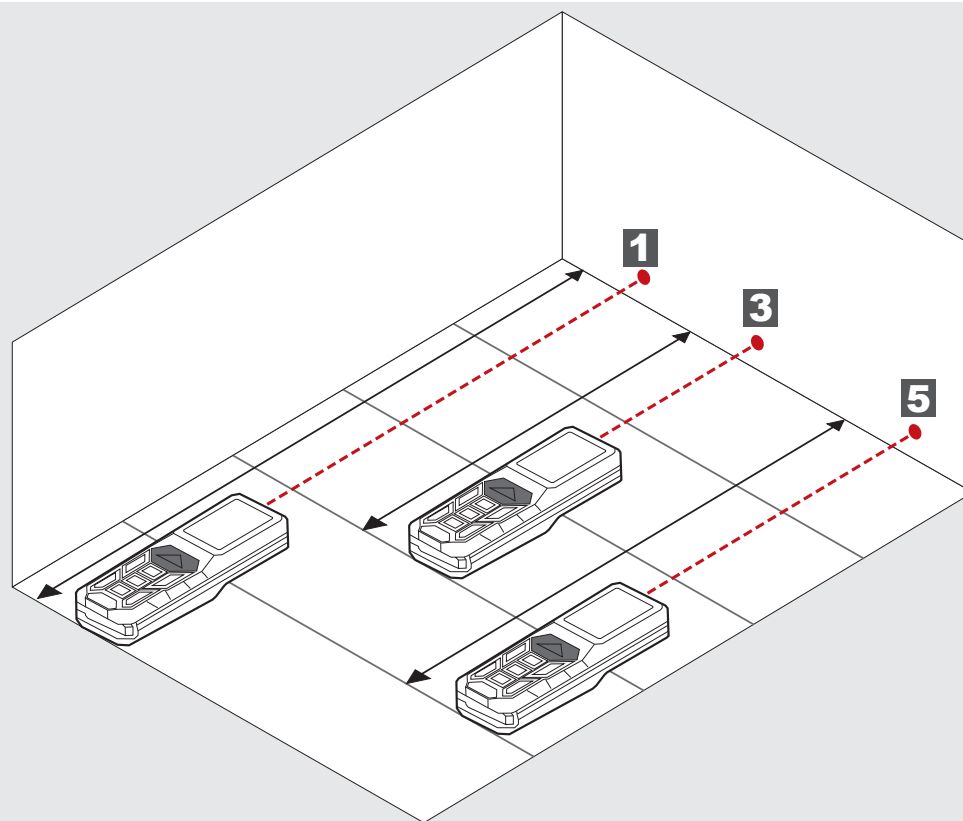
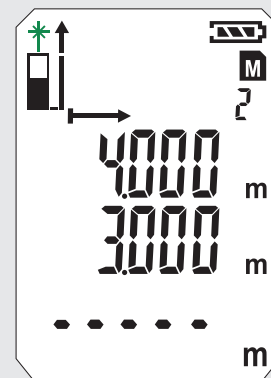
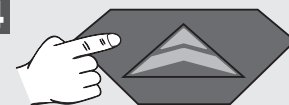

5

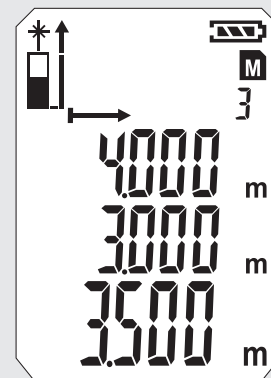
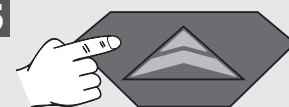

FOLYAMATOS MÉRÉS/ MINIMUM-MAXIMUM MÉRÉS

0

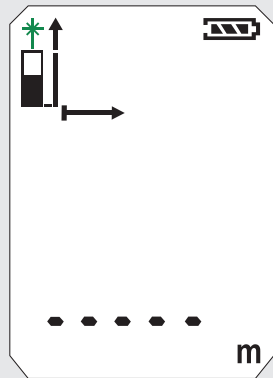

1

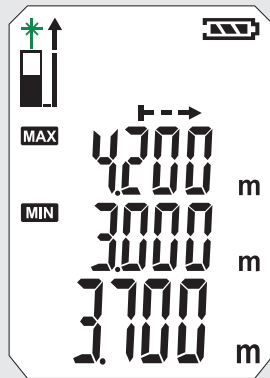
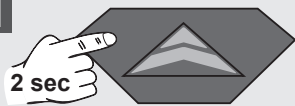

2

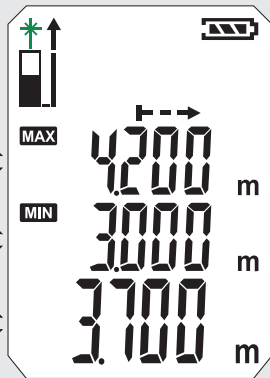

3

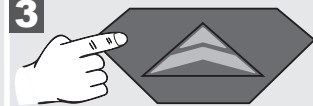

Stop
MIN / MAX

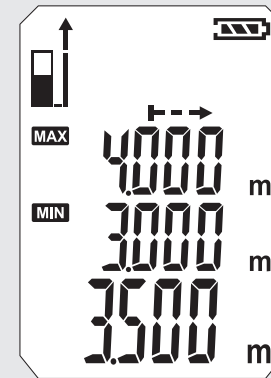

4

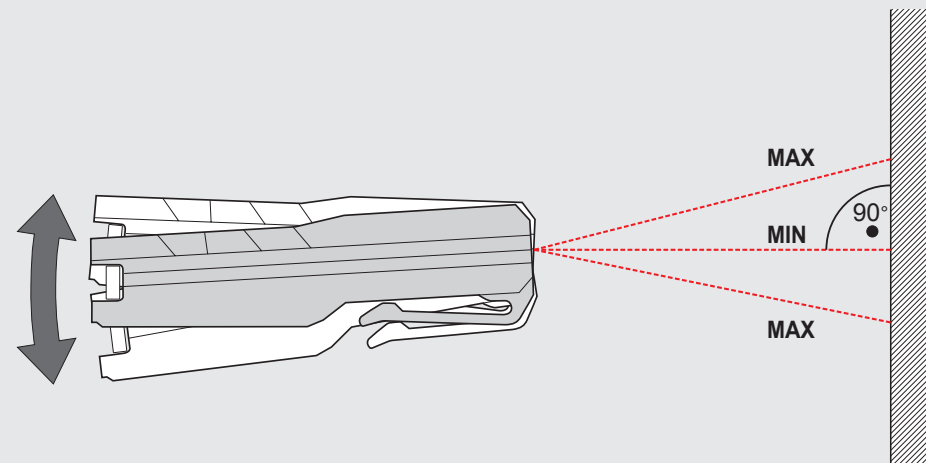
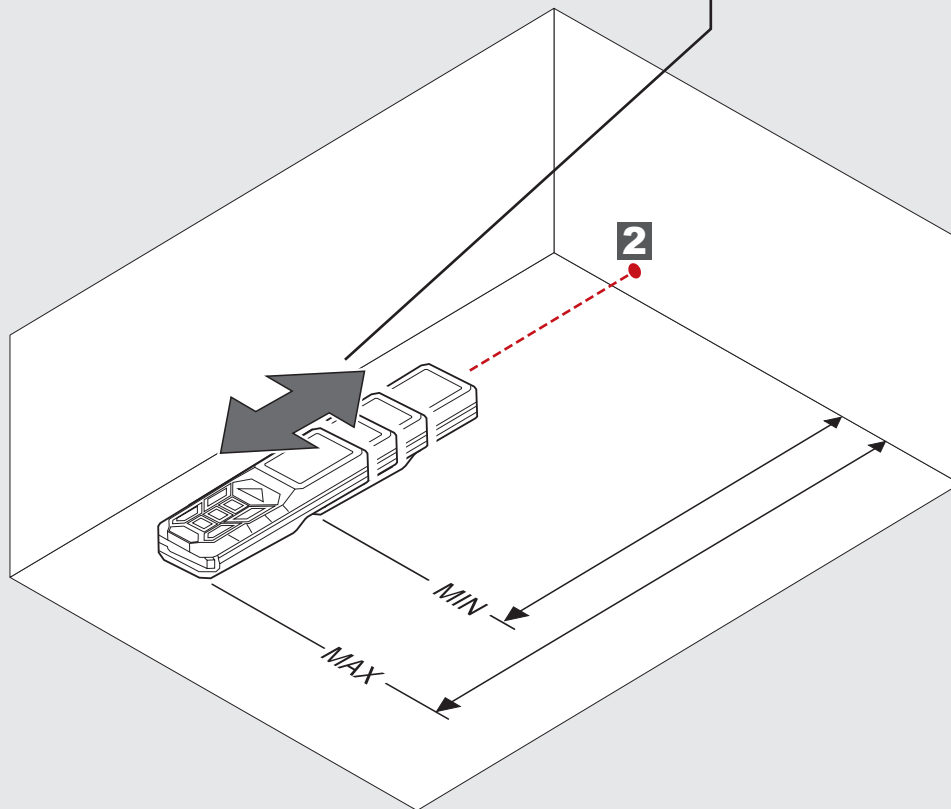
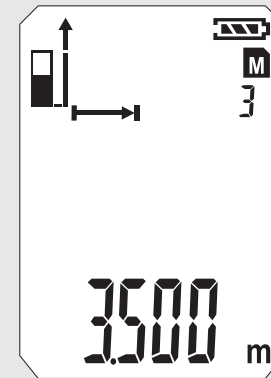
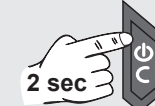

0

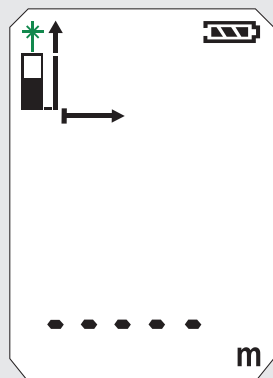

1

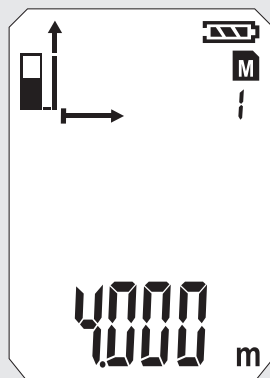
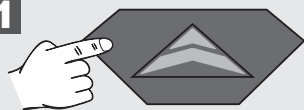

2

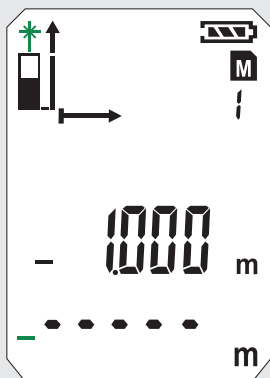

3

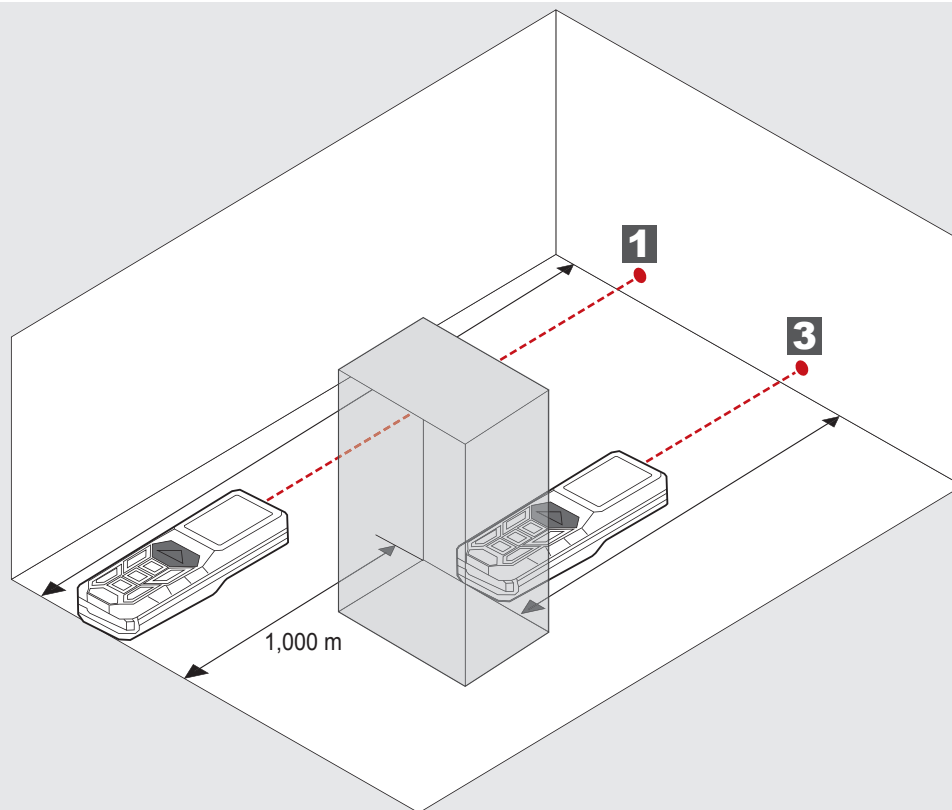
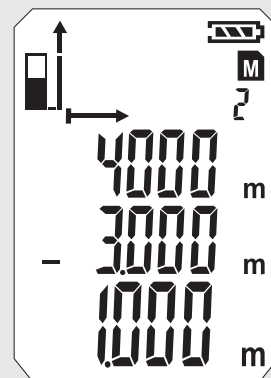
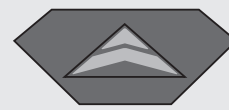

FELÜLETMÉRÉS

0



1

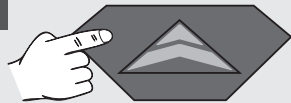

2

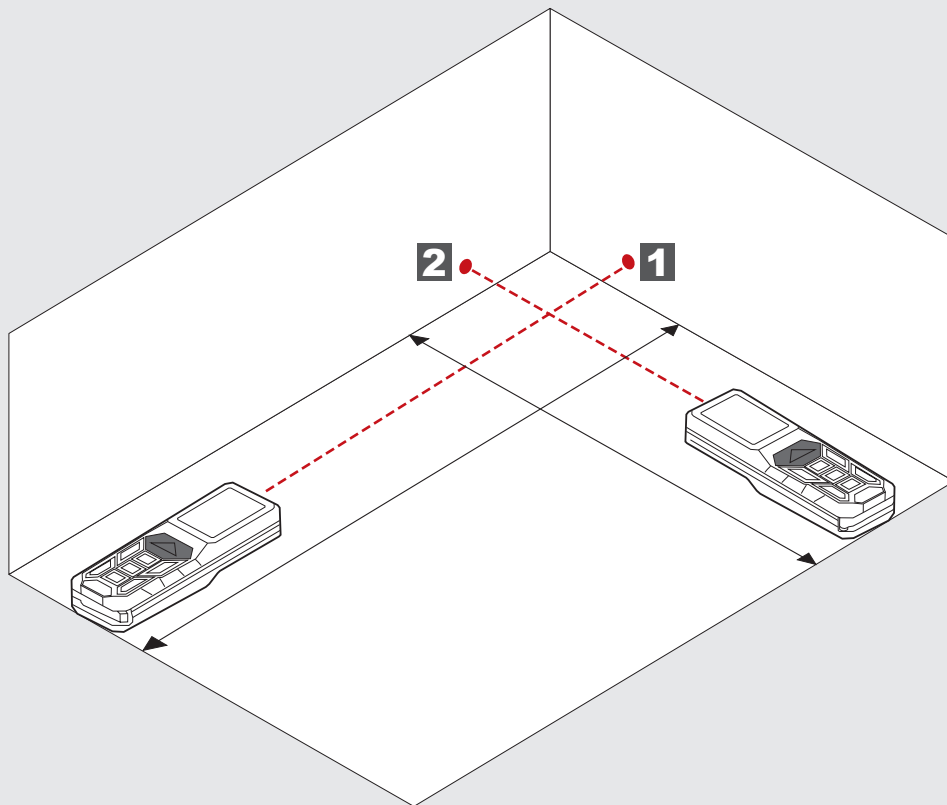
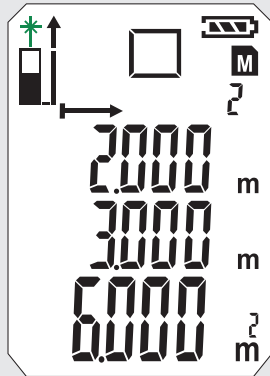
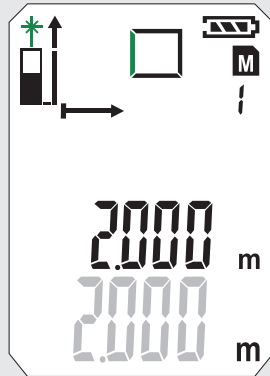
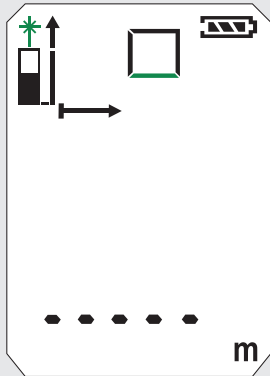
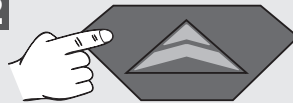

TÉRFOGATMÉRÉS

0

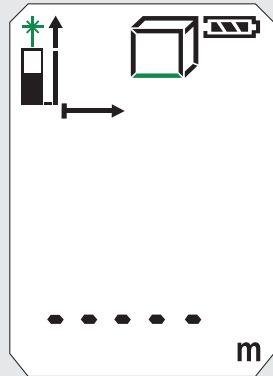

1

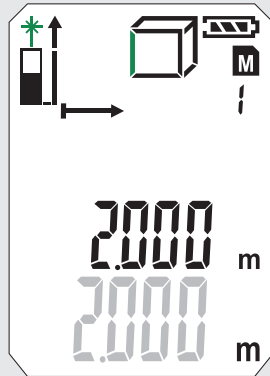
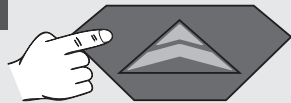

2

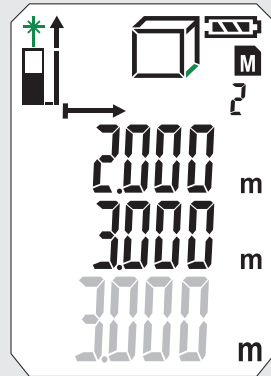
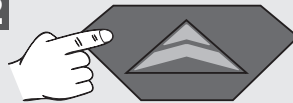

3

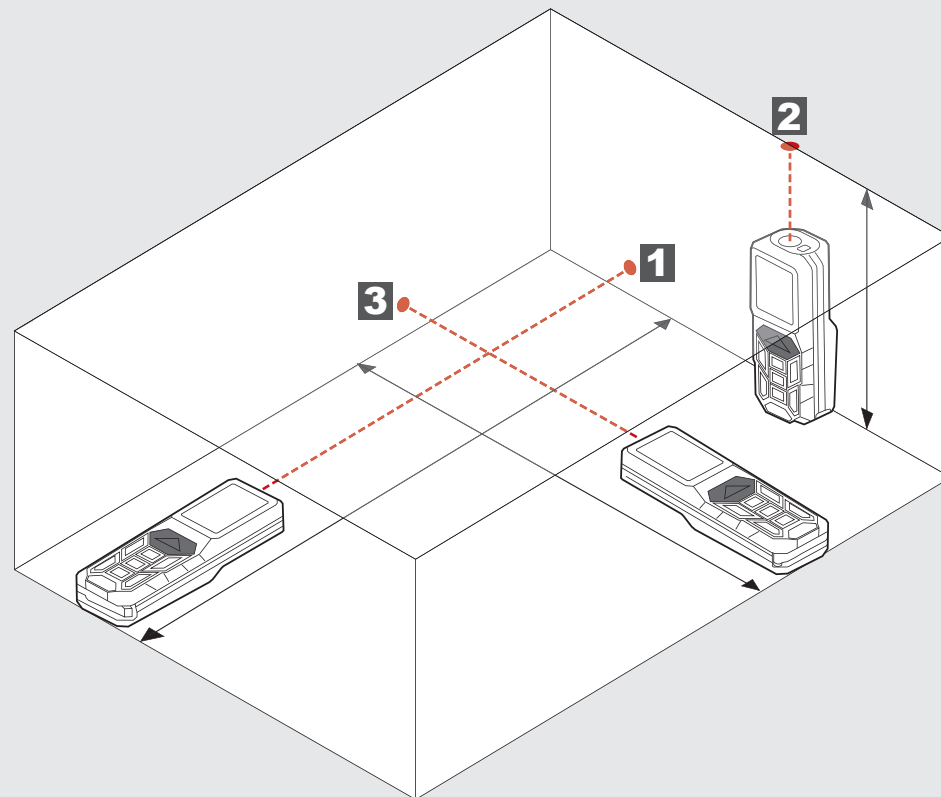
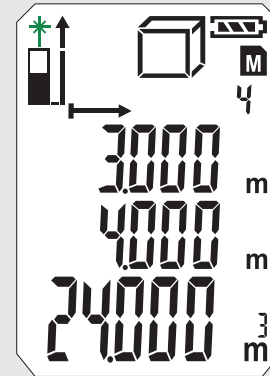
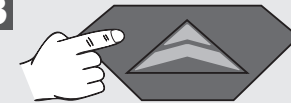

INDIREKT MÉRÉS (PITAGORASZ 1)

0



1

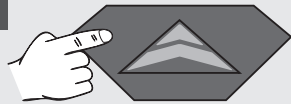

2

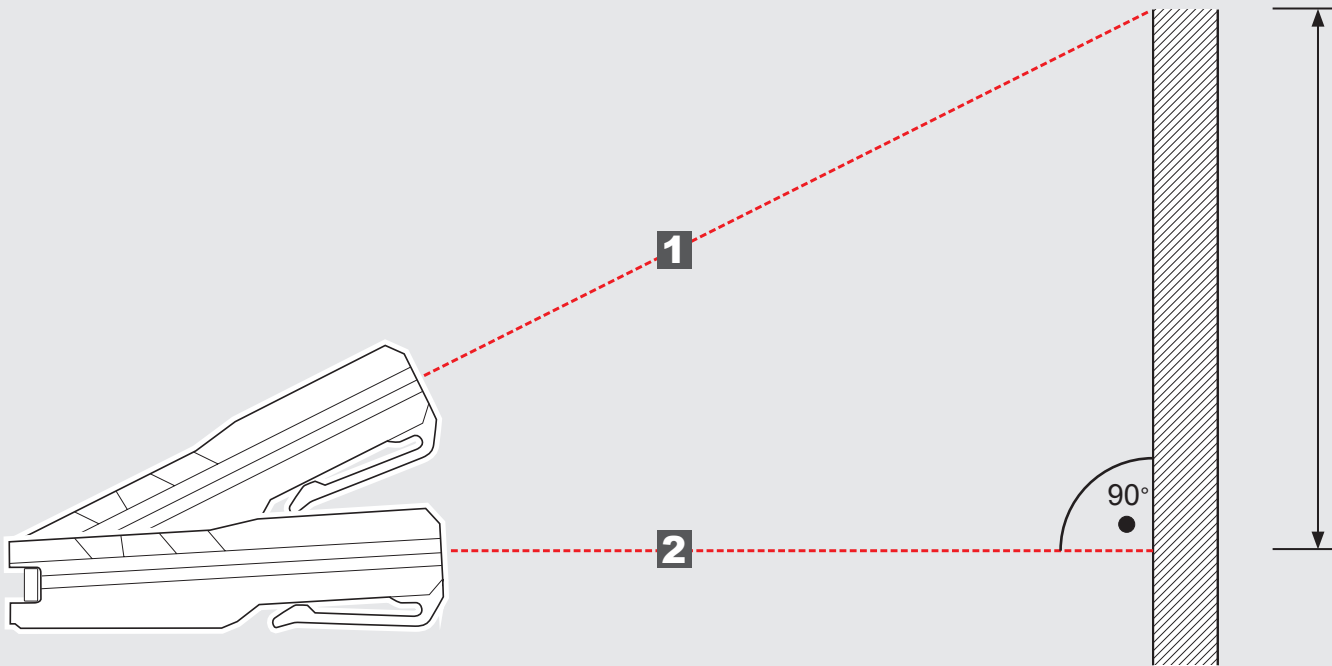
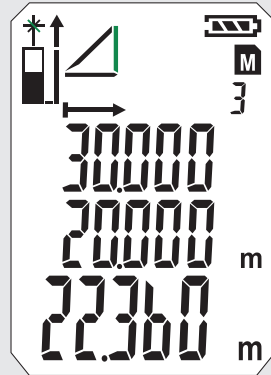
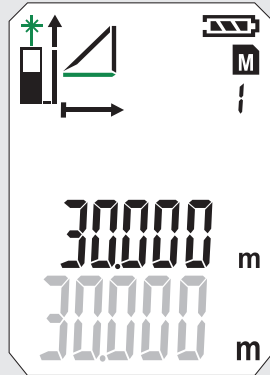
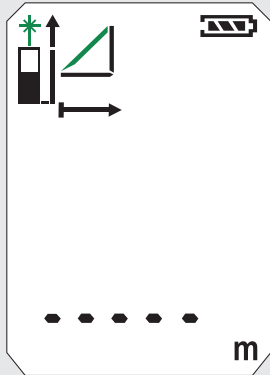
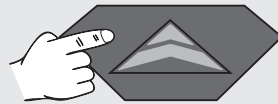

INDIREKT MÉRÉS (PITAGORASZ 2)

0



1

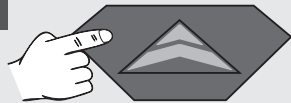

2

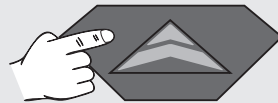

3

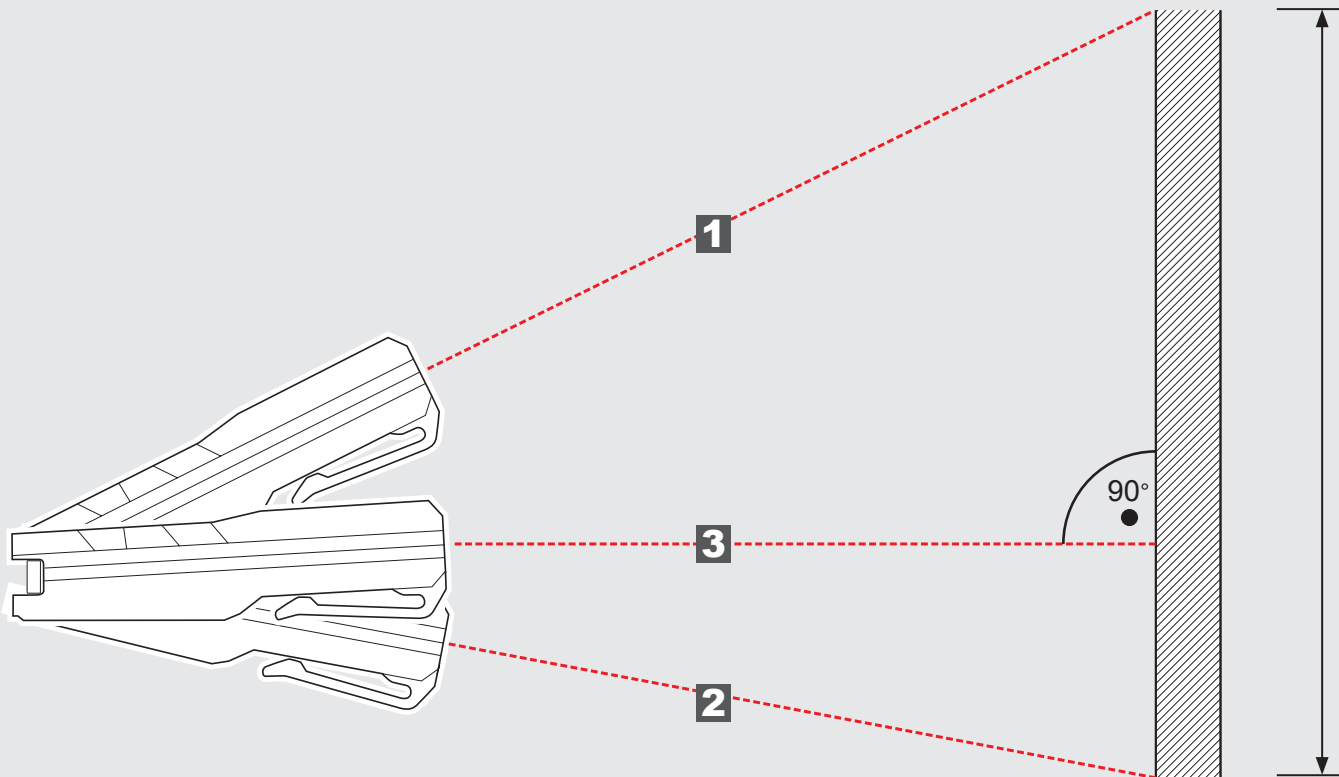
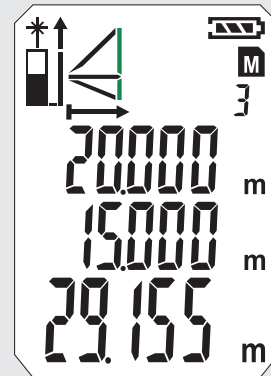
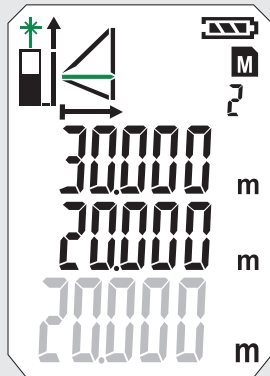
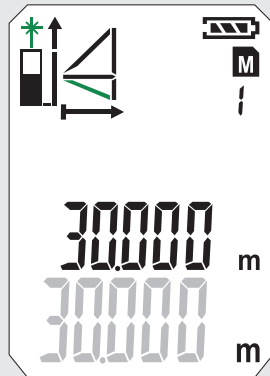
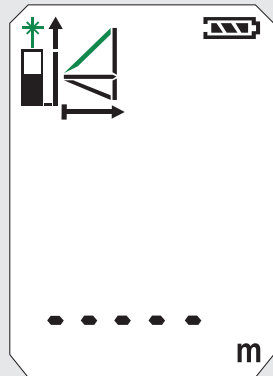
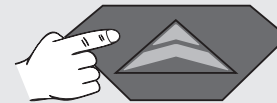

INDIREKT MÉRÉS (PITAGORASZ 3)

1



2

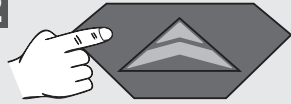



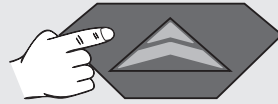

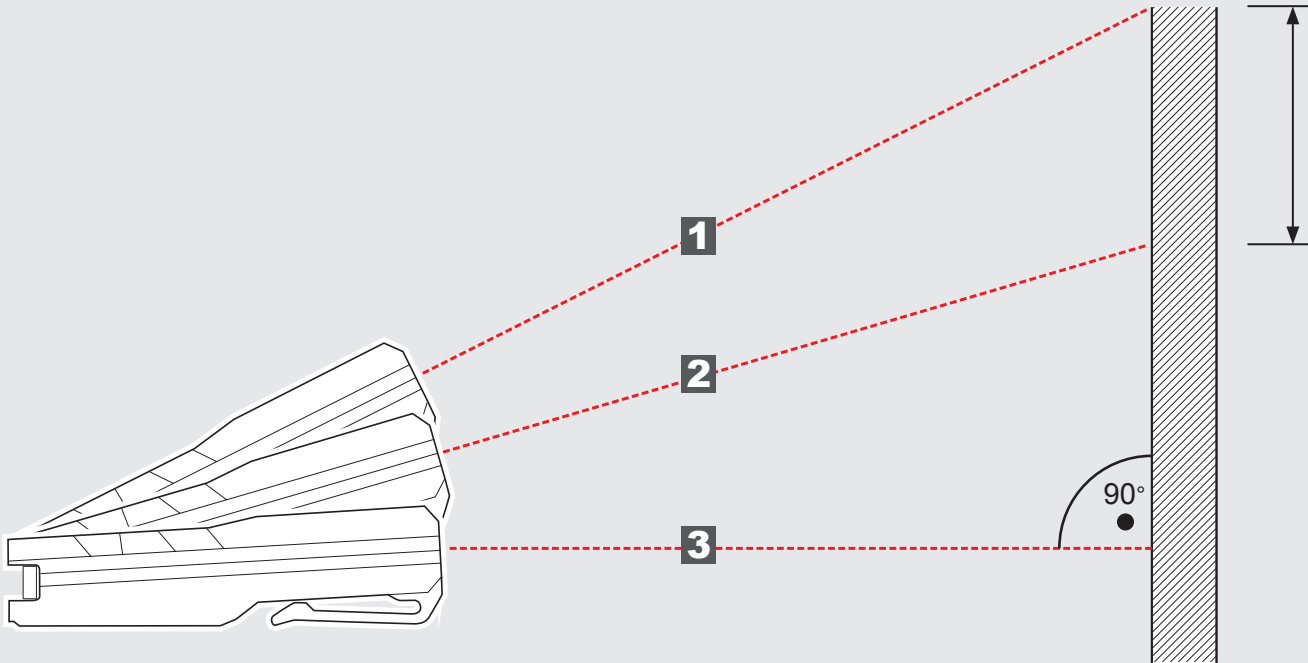
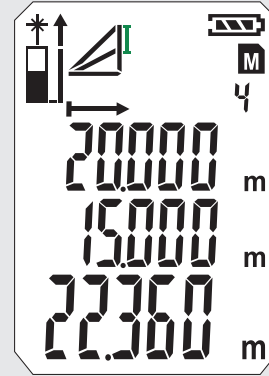
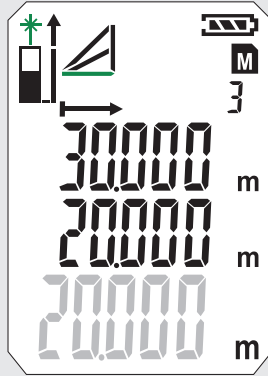
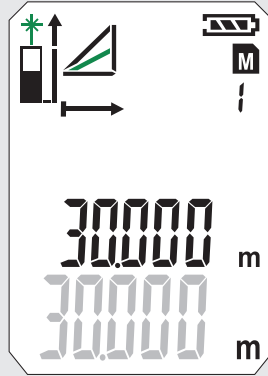
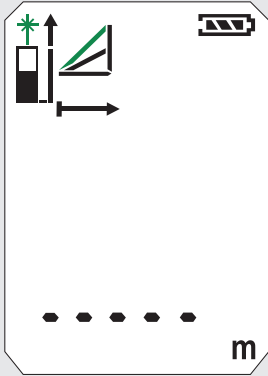
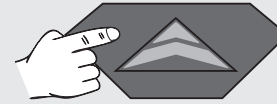

3



4

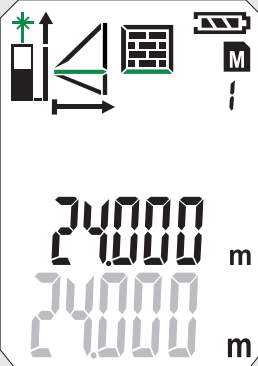
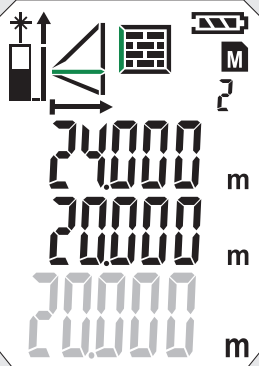
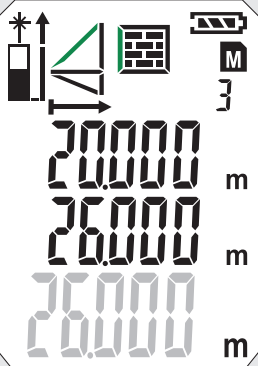
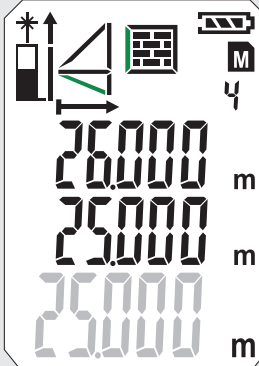

FALFELÜLET MÉRÉSE (1. FORGATÓKÖNYV)

0 	1 	2 	3 	4 
				

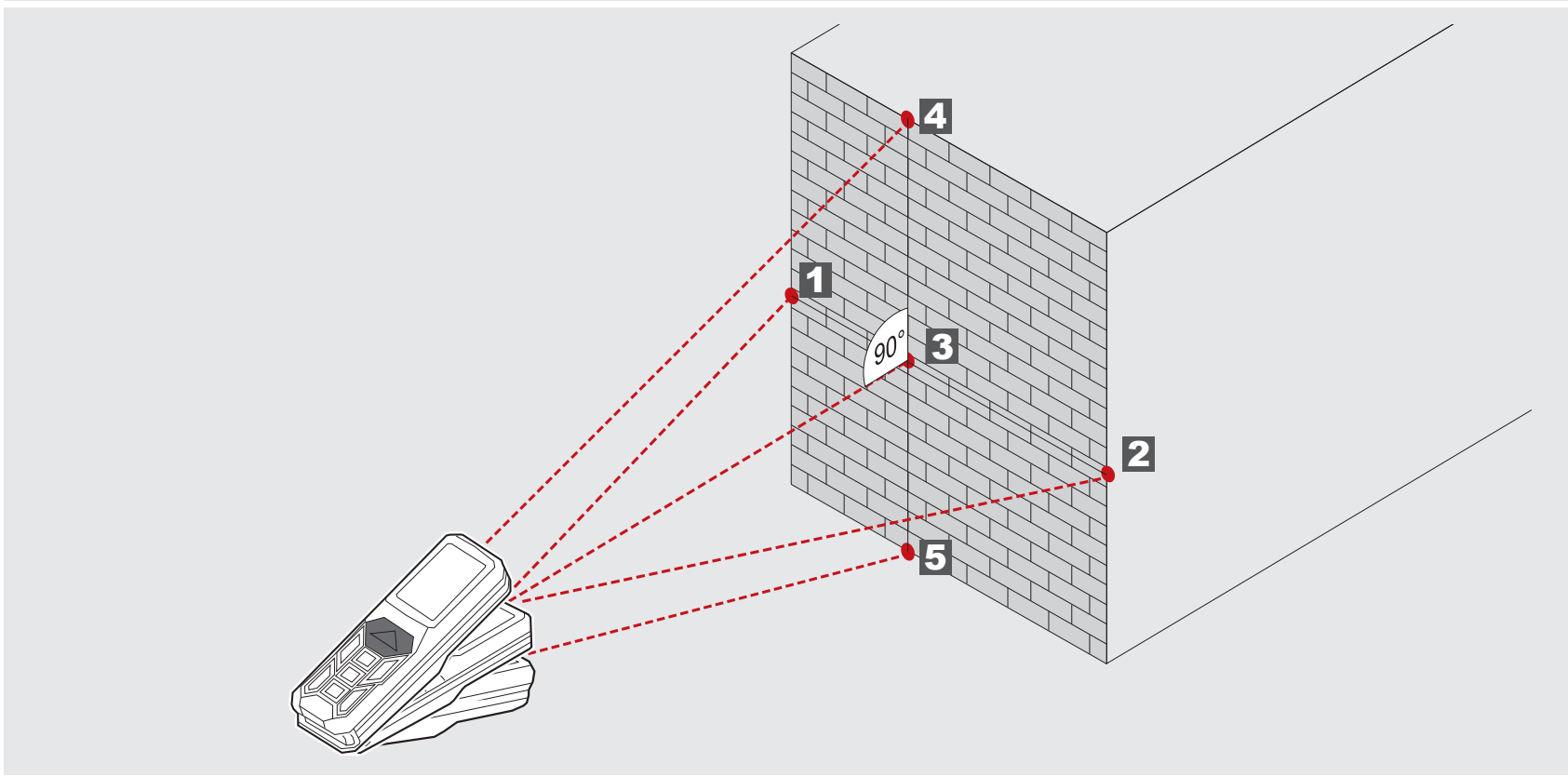



5

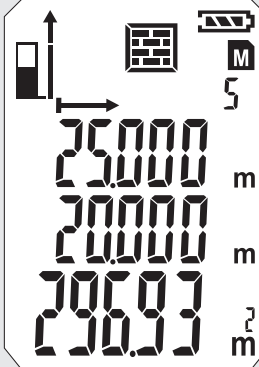

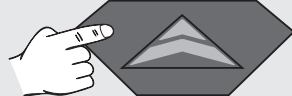
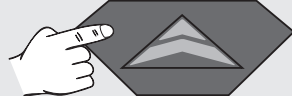
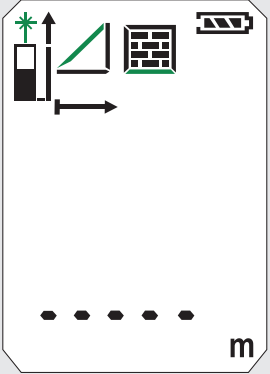
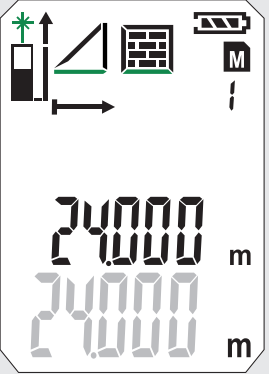
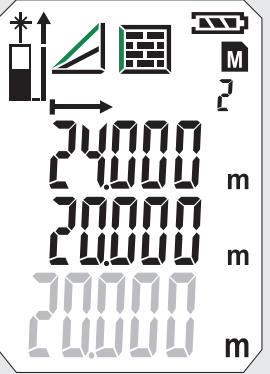
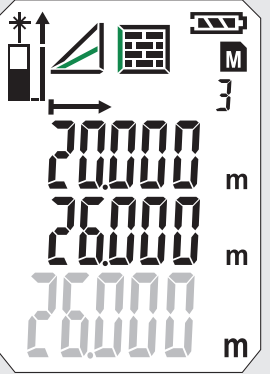
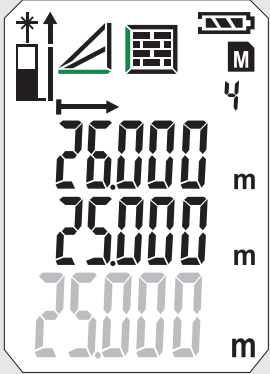

FALFELÜLET MÉRÉSE (2. FORGATÓKÖNYV)

0 	1 	2 	3 	4 
				

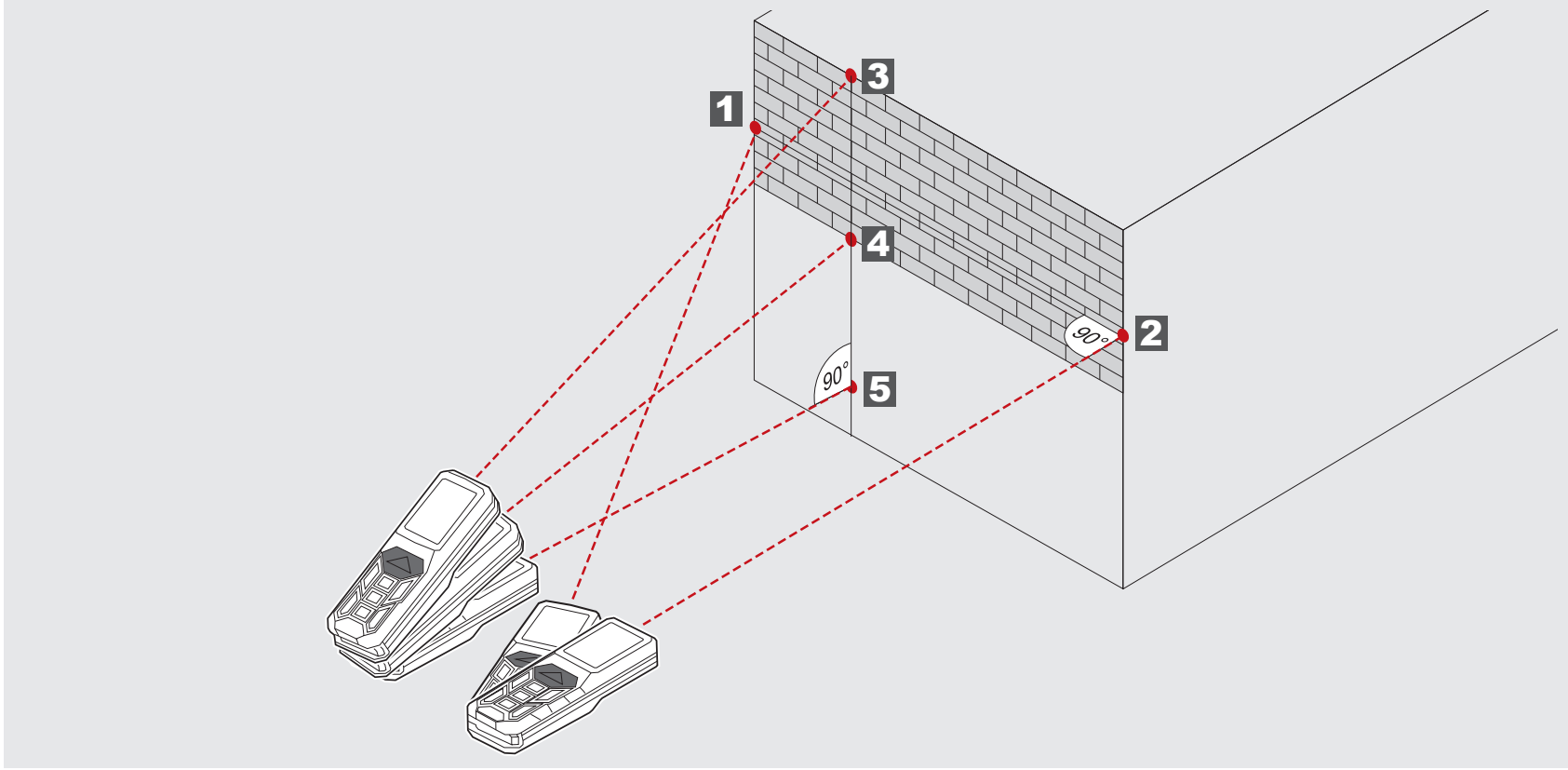

5



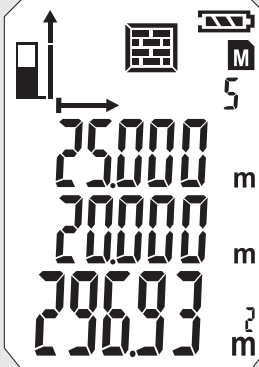



IDŐZÍTŐ

Az időzítővel a mérés késleltetve indítható, pl. egy adott szerkezeti elem/alkatrész mérősugarban történő pozicionálásához.

A  gomb lenyomása

- Megjelenik a szimbólum
- A  gomb lenyomásával az időzítő 3 és 15 mp közötti értékre állítható be.

A  gomb lenyomása

- A másodpercek visszaszámlálódnak a mérésig.
- 0 esetén elkezdődik a mérés.

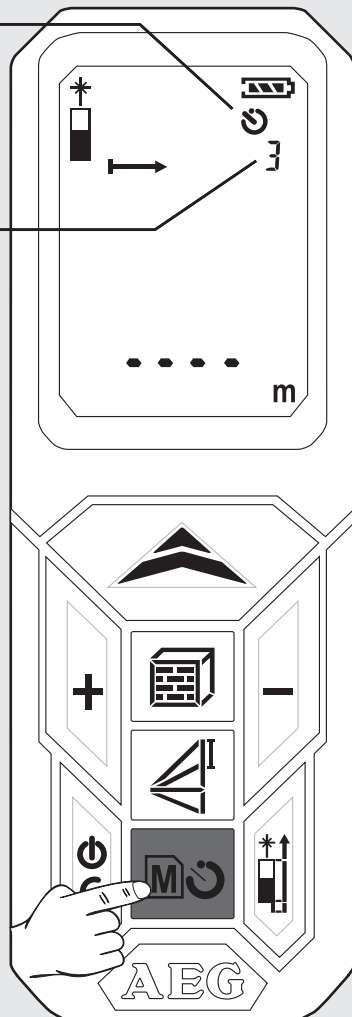

MEMÓRIA

A mért értékek automatikusan, folyamatosan tárolódnak el a memóriában.

Az eltárolt értékek a  gombbal hívhatók le.

A  gomb lenyomása 2 mp-ig

- Megjelenik a szimbólum és a memóriahely.
- Megjelenik a hozzá tartozó mért mennyiség.
- Az eltárolt érték a fő sorban jelenik meg.
- Navigálás a +/- gombokkal

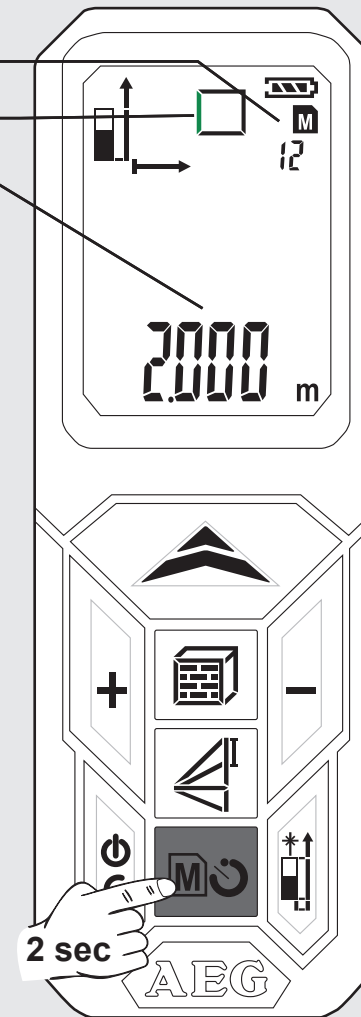

ALAPVETŐ MŰKÖDÉSMÓD FELÜLETMÉRÉS PÉLDÁJÁN (1)

1 Bekapcsolás



Nyomja meg a  gombot.

 **Figyelem!** A lézersugár be van kapcsolva!
Ne irányítsa személyekre!

Ne irányítsa személyekre!

2 Mérési sík választása

Standard beállítás bekapcsolás után: hátul

 megnyomása 1x -> sarok stift
 megnyomása 2x -> elől
 megnyomása 3x -> hátul

3 Funkció választása

Bekapcsolás után a készülék mindig hossz mérésen áll.

 megnyomása 1x - Felületmérés

4 Hosszúság mérése

A készülék beállítása és a  gomb lenyomása

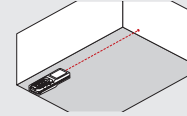

5 Szélesség mérése

A készülék beállítása és a  gomb lenyomása

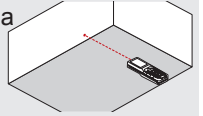

Lézer szimbólum villog (villogó zöld színnel ábrázolva).

Megjelenik a szimbólum

- Megjelenik a szimbólum
- A mért mennyiség villog (villogó zöld színnel ábrázolva)

- A mért érték röviden megjelenik a fő sorban.
- A mért érték 1 mp után a felette lévő sorba ugrik.
- A mért érték a memóriában folyamatos számozással tárolódik el.
Villog a második mért mennyiség.
A készülék kész a második érték mérésére.

- A mért érték röviden megjelenik a fő sorban.
- A mért érték 1 mp után a felette lévő sorba ugrik.
- A mért érték a memóriában folyamatos számozással tárolódik el.
- Az eredmény megjelenik a fő sorban, és a memóriában folyamatos számozással eltárolódik.

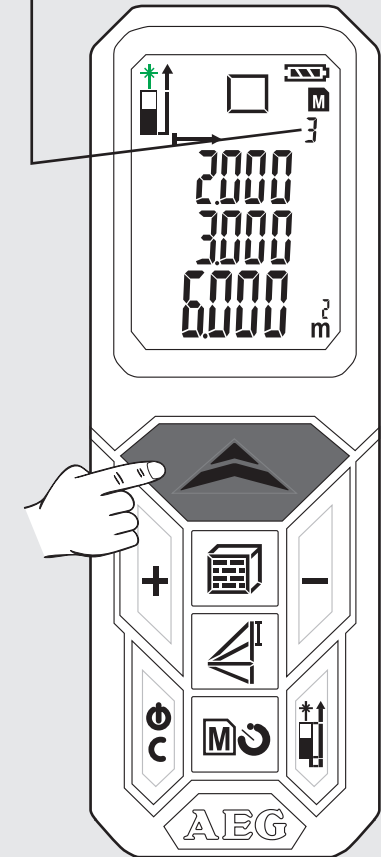
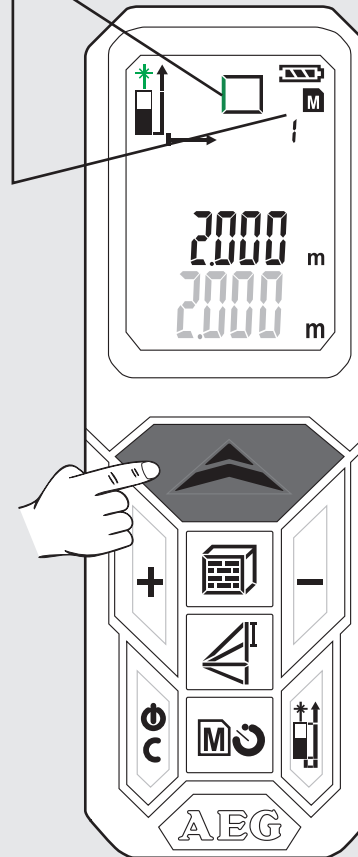
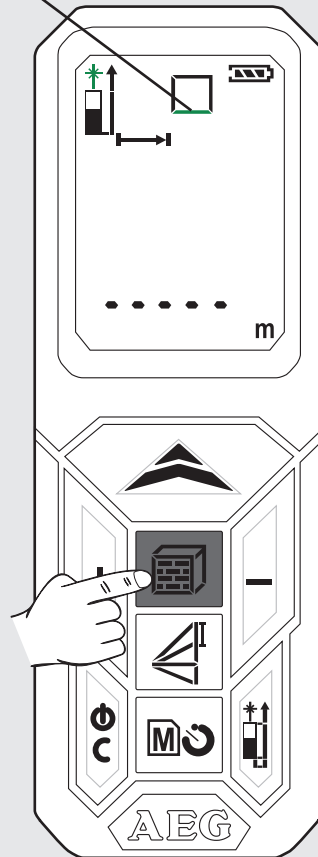
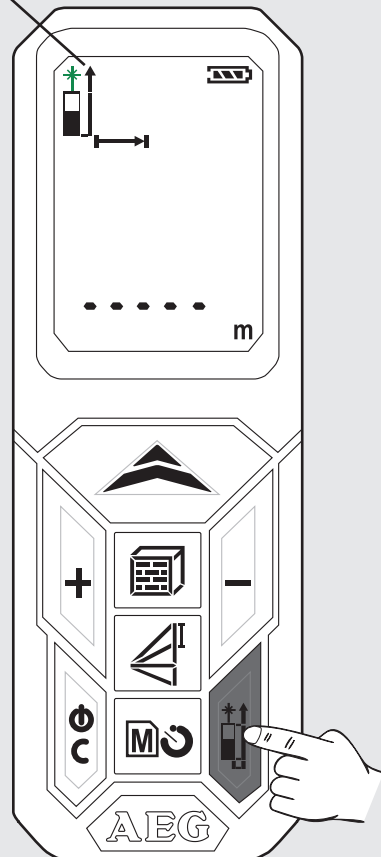
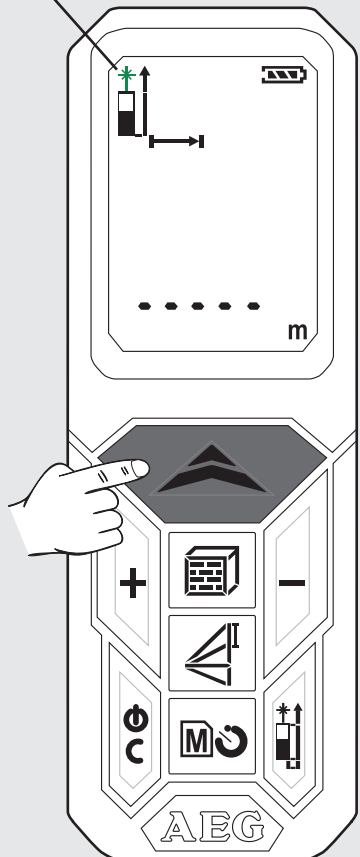

ALAPVETŐ MŰKÖDÉSMÓD FELÜLETMÉRÉS PÉLDÁJÁN (2)

6 Tárolt értékek lehívása

Nyomja le a  gombot 2 mp-ig.
+ vagy - gomb lenyomása

- Az eltárolt értékek a fő sorban jelennek meg.

Megjelenik a hozzá tartozó szimbólum, és a mért mennyiség villog (villogó zöld színnel ábrázolva).

7 Kilépés a memóriából

A  gomb lenyomása

8 Kikapcsolás

Nyomja le a  gombot 2 mp-ig (előzőleg ki kell lépni a memóriából).

- A készülék lekapcsol.

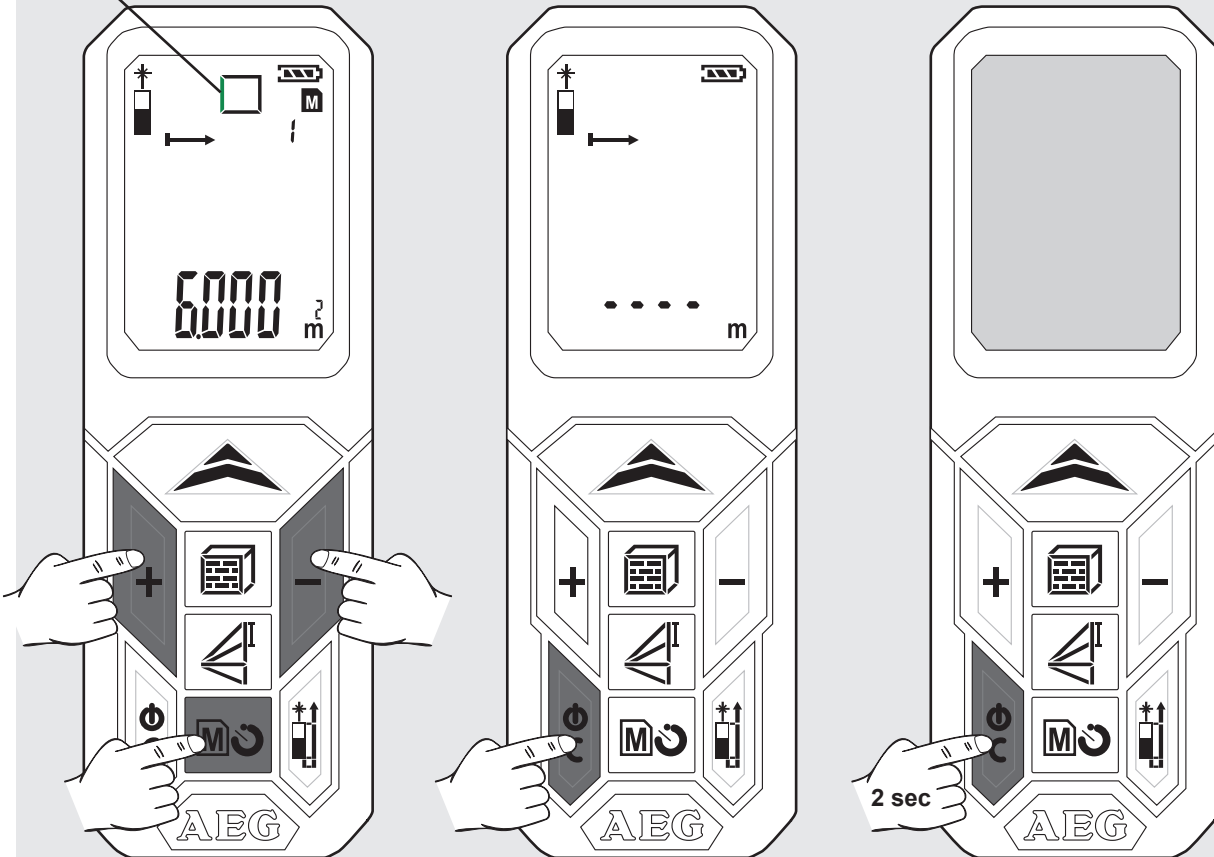

- Ha 3 másodpercig nem nyomnak le egyetlen gombot sem, akkor a készülék automatikusan lekapcsol.



VSEBINA

Pomembna varnostna navodila.....	1
Tehnični podatki.....	2
Uporaba v skladu z namembnostjo.....	2
Kodna tabela napak.....	2
Pregled.....	3
Zamenjava baterij.....	4
Kotni zatič.....	4
Držalo pasu.....	4
Funkcijska tipka, Pitagora, Merilna ploskev.....	5
Enostavna meritev dolžine.....	6
Kontinuirano merjenje / Meritev minimuma-maksimuma.....	7
Merietv z dodajanjem / Subtrakcijo.....	8
Merjenje površin.....	9
Merjenje volumna.....	10
Posredna meritev (Pitagora 1).....	11
Posredna meritev (Pithagora 2).....	12
Posredna meritev (Pitagora 3).....	13
Meritev zidne površine (Scenarij 1).....	14
Meritev zidne površine (Scenarij 2).....	15
Timer.....	16
Pomnilnik.....	16
Osnovno delovanje na primeru merjenja površine (1).....	17
Osnovno delovanje na primeru merjenja površine (2).....	18

POMEMBNA VARNOSTNA NAVODILA

  Izdelka ne uporabljajte preden ne preučite varnostnih navodil in uporabniškega priročnika na priloženi zgoščenki.

Klasifikacija laserja

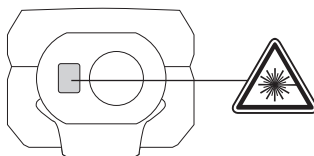

OPOZORILO:

To je laserski proizvod **razreda 2** v skladu s IEC 60825-1:2007.



Napis

Pred prvim zagonom prelepote angleško besedilo na podatkovni tablici z dobavljeno nalepko v jeziku vaše države.

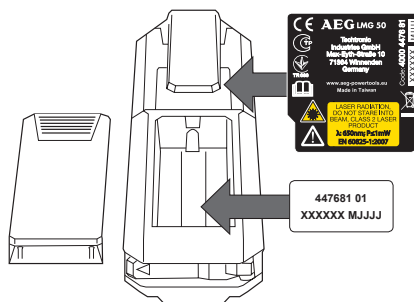

Opozorilo:

Izogibajte se neposrednemu stiku z očmi. Laserski žarek lahko z bliskom obsije oči in privede do kratkočasne zaslepitve.

Ne zrite v laserski žarek ali ga usmerjajte neposredno v druge osebe.

Pazite, da ne zaslepitate drugih oseb.

Opozorilo:

Laserske naprave ne uporabljajte v bližini otrok ali otrokom dovoljevati uporabo le te.

Pozor! Odsevna površina lahko laserski žarek zrcali nazaj k upravljalcu ali v druge osebe.

Ohranite varno razdaljo med okončinami in premičnimi deli.

Izvajajte občasna testna merjenja. Še posebno med in po pomembni meritvi.

Bodite pozorni na nepravilne merilne razdalje, v primeru, da naprava ne deluje pravilno, da je padla na tla oziroma, da je bila nepravilno uporabljena ali spremenjena.

Pozor! Seznanite se z upravljalnimi elementi in s pravilno uporabo vrtnega orodja.

Laserska merilna naprava ima omejeno območje uporabe. (glej razdelek "Tehnični podatki"). Preizkusi meritev izven maksimalnega in minimalnega območja, povzročajo nenatančnosti. Uporaba v vremenskih pogojih, kot je v prevročem, prehladnem, pri zelo močni sončni svetlobi, v dežju, snegu, megli ali drugih pogojih z omejeno vidljivostjo, lahko privedejo do nenatančnih meritev.

Kadar lasersko merilno napravo prenesemo iz toplega okolja v hladno (ali obratno), počakajte, dokler se naprava ni prilagodila novi temperaturi okolice.

Lasersko merilno napravo zmeraj shranjujte v notranjosti prostorov, napravo zaščitite pred tresljaji, vibracijami ali zunanji temperaturami.

Lasersko merilno napravo zaščitite pred prahom, mokroto in visoko zračno vlažnostjo. Le ti lahko uničijo notrenje komponente ali vplivajo na natančnost.

Ne uporabljajte agresivnih čistilnih sredstev ali redčil. Čistite zgolj s čisto, mehko krpo.

Izogibajte se močnih udarcev in padcev laserske merične naprave. V kolikor je padla na tla ali je bila izpostavljena drugim mehanskim obremenitvam, prevrte natančnost naprave.

Potrebna popravila sme na laserski napravi izvajati zgolj strokovno osebje.

Izdelka ne uporabljajte v eksplozivnih nevarnih področjih ali v agresivnih okoljih.

Baterijske vložke polnite s polnilniki, ki jih priporoča proizvajalec.

 Ploskih baterij ne smete zavreči skupaj z gospodinjstvi odpadki. Skrbite za okolje in izdelek odnesite na zbiralne točke, ki so na voljo v skladu z državnimi ali lokalnimi uredbami. Izdelka ne smete zavreči skupaj z gospodinjstvi odpadki. Izdelek primerno zavržite, v skladu z veljavnimi državnimi uredbami vaše države. Upoštevajte nacionalne in državne predpise posamezne države. Za informacije glede odstranjevanja se obrnite na krajevni urad ali vašega trgovca.

 CE-znak

TEHNIČNI PODATKI

Zaščitni razred	IP54 (zaščita pred prahom in pršenjem vode)
Optika	14 mm
Fokus	35 mm
Merilno območje maks.	50 metrov (toleranca: 55m)
Merilno območje min.	0,05 metrov
Absolutna natančnost @ < 10m	± 1,5 mm (maks)
Natančnost ponovitve @ < 10m	± 1,5 mm (tipično maks. 2σ)
Natančnost ponovitve @ > 10m	porast ± 0,25 mm / metrov (tipično maks. 2σ)
Čas meritve	0,5 s
Tip displeja	LCD (22,7 mm x 31 mm)
Napajanje	AAA 2x (alkalne baterije)
Obratovalna doba	10000 (posamična meritev)
Izhodna moč laserja	0,6 mW ~ 0,95 mW (razred 2, 650nm)
Velikost laserske točke	25 x 30 mm @ 16 m (maks)
Navpični kot laserskega žarka	+1 stopinja
Vodoravni kot laserskega žarka	±1 stopinja
Avtomatski izklop naprave	180 sekund
Avtomatski izklop laserja	30 sekund
Območje delovne temperature	-10°C do +50°C
Območje temperature shranjevanja	-25°C do +70°C
Teža brez baterij	80 g

UPORABA V SKLADU Z NAMEMBNOSTJO

Laserska merilna naprava je namenjena merjenju razdalj in naklonov.

Ta naprava se sme uporabiti samo v skladu z namembnostjo uporabiti samo za navede namene.

KODNA TABELA NAPAK

Code	Opis	Rešitev
Err01	Izven območja meritve	Meritev izvedite v predvidenem območju.
Err02	Odsevni signal je prešibek	Izberite boljšo površino.
Err03	Izven območja prikaza (maks. Wert: 99.999) npr. izid površine ali volumna je izven območja prikaza	Preverite, ali so vrednosti in koraki pravilni.
Err04	Napaka v Pitagora izračunu	Preverite, ali so vrednosti in koraki pravilni.
Err05	Oslabljen baterija	Vstavite nove baterije.
Err06	Izven temperature delovnega območja	Meritev izvedite v navedenem delovnem območju temperature.
Err07	Prevelika svetloba okolice	Ciljno območje zatemniti.

Pitagora
Razlika višine

Merilna ploskev

Meritev dolžine

Minimum / Maksimum za kontinuirano merjenje

Dodajanje / Subtrakcija

Površina / Volumen
Posredna meritev površine

Stanje baterij

Pomnilnik

Timer

Kontinuirano merjenje

Vmesne vrednosti

Skupna vrednost

VKLOP / MERJENJE

- ▶ Vklop
- ▶ Merjenje
- ▶ Kontinuirano merjenje (pritisnite 2 sekundi)
Min. / Maks. funkcija

DODAJANJE

- ▶ Dodaj vrednost
- ▶ Navigiranje po pomnilniku

POVRŠINA / VOLUMEN

- ▶ Površina (pritisnite 1x)
- ▶ Volumen (pritisnite 2x)
- ▶ Posredna meritev površine (pritisnite 3x / 4x)

VKLAPLJANJE

- ▶ Vklop
- ▶ Izklop (pritisnite 2 sekundi)
- ▶ Prestavite nazaj

SUBSTRAKCIJA

- ▶ Substrahiranje vrednosti
- ▶ Navigacija po pomnilniku

PITAGORA

- ▶ Pitagora 1 (pritisnite 1x)
- ▶ Pitagora 2 (pritisnite 2x)
- ▶ Pitagora 3 (pritisnite 3x)

MENJAVA MERILNE PLOSKVE

- ▶ Spredaj
- ▶ Zadaj
- ▶ Kotni zatič

POMNILNIK

- ▶ Timer 3-15 sek (pritisnite 1x)
- ▶ Pomnilnik 1-20 (pritisnite 1x 2 sekundi)
- ▶ S tipkama +/- navigirajte po pomnilniku

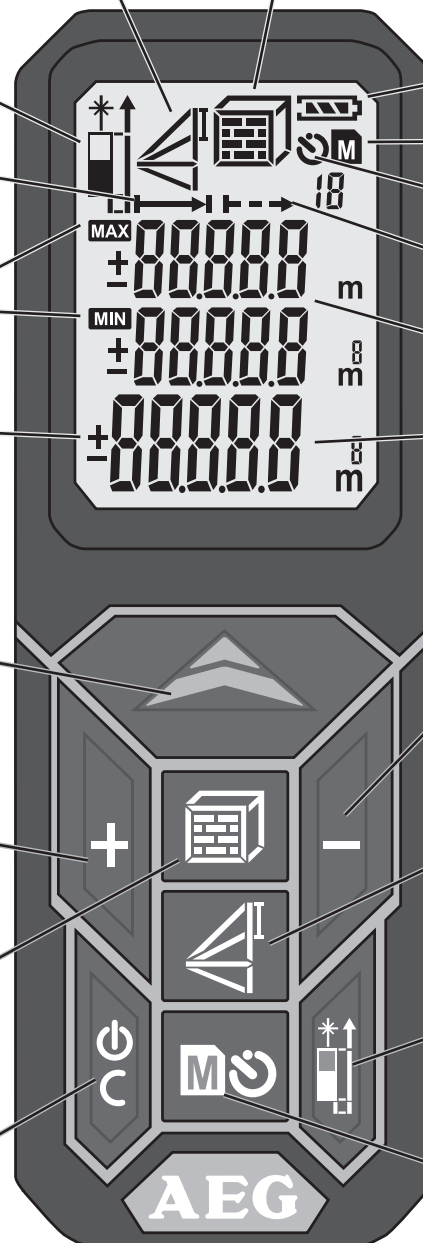

ZAMENJAVA BATERIJ

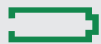
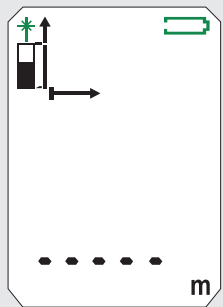

Kadar simbol utripa, zamenjajte baterijo.

1

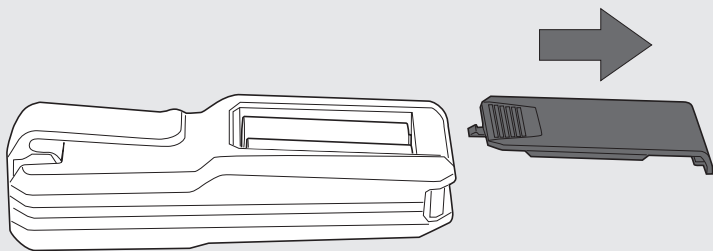

2

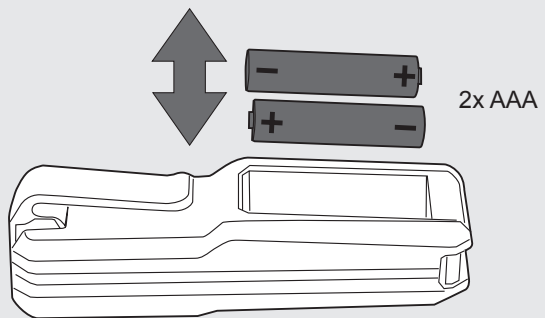

3

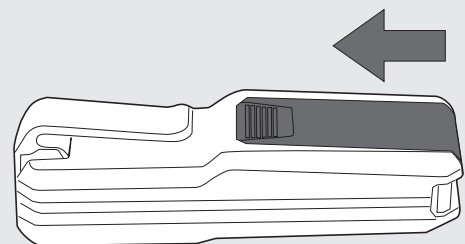

KOTNI ZATIC

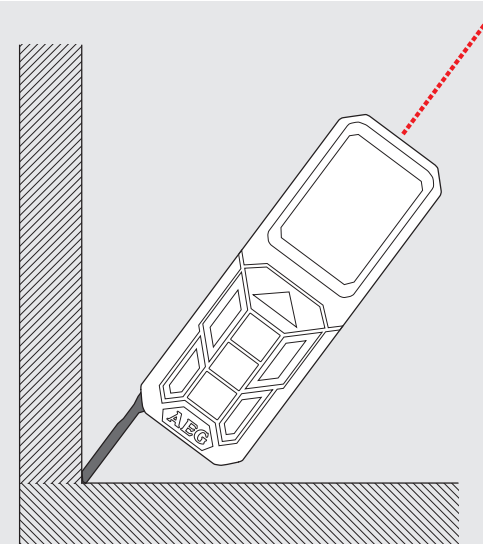
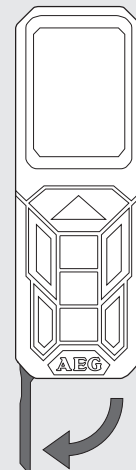

DRŽALO PASU

1

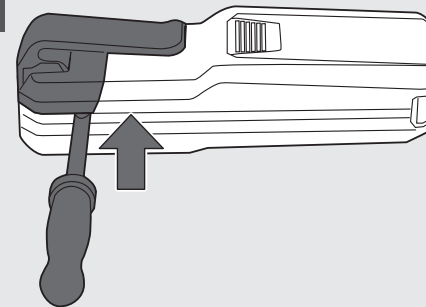

2

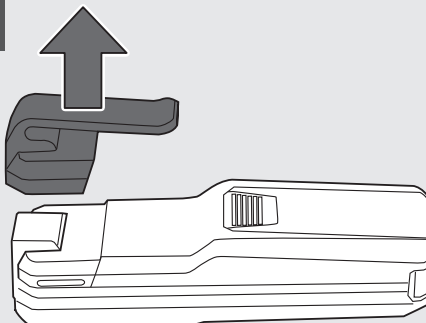

3

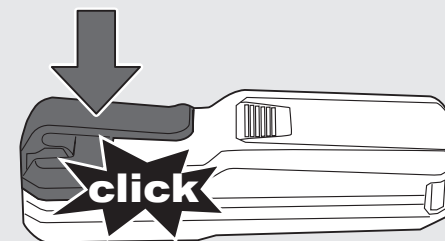

FUNKCIJSKA TIPKA, PITAGORA, MERILNA PLOSKEV

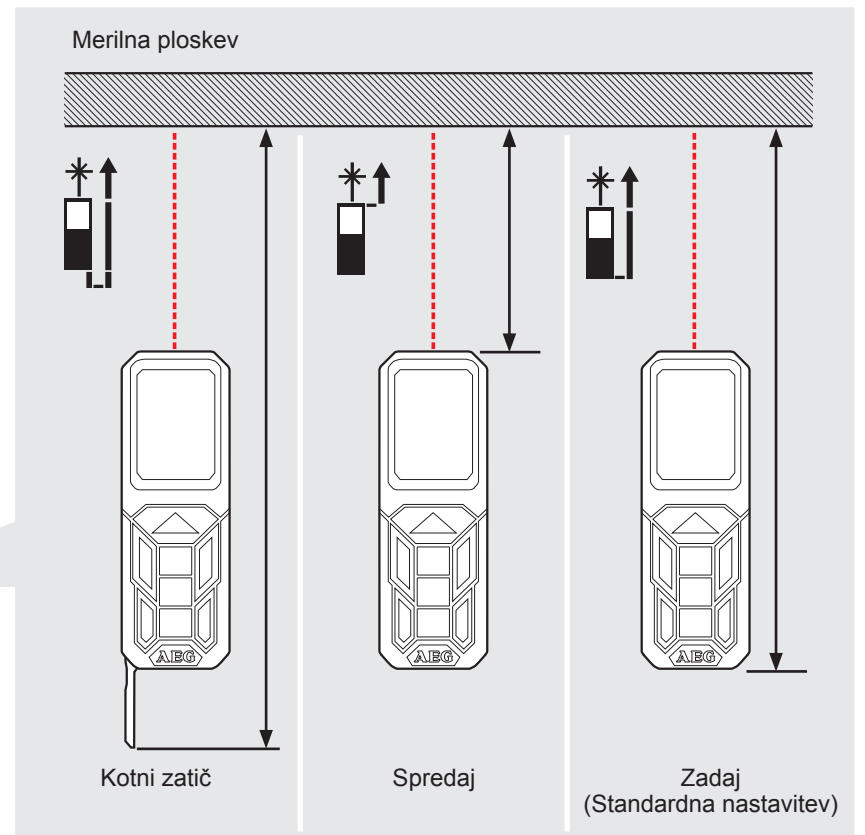
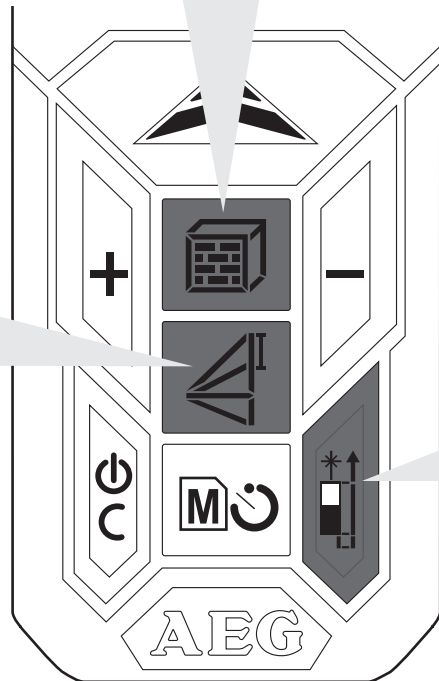
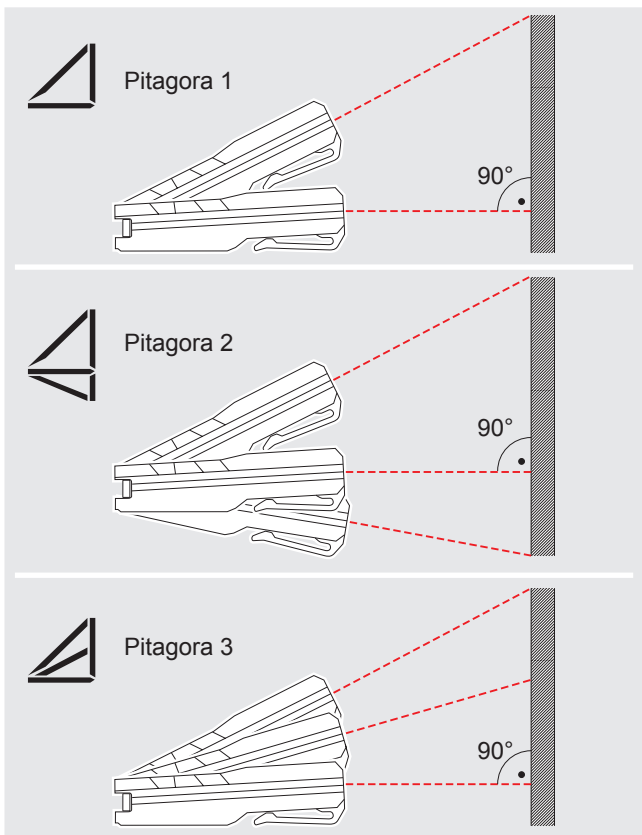
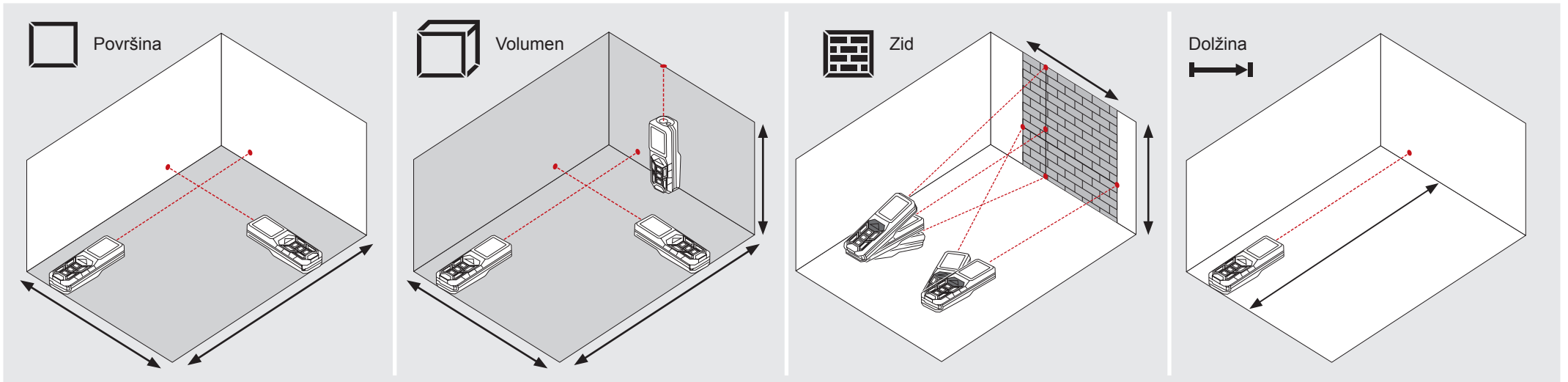

ENOSTAVNA MERITEV DOLŽINE

0

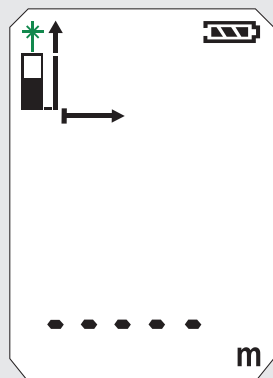

1

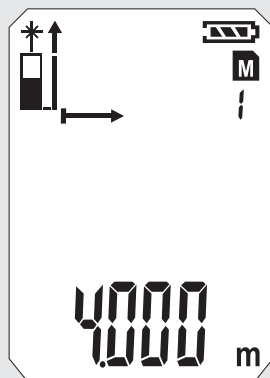
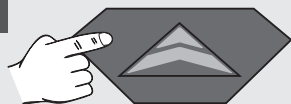

2

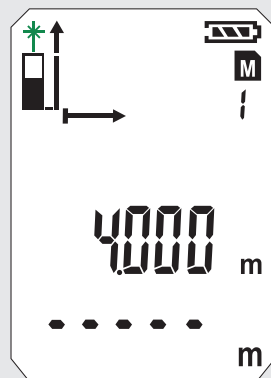
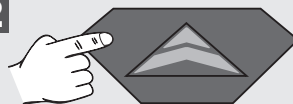

3

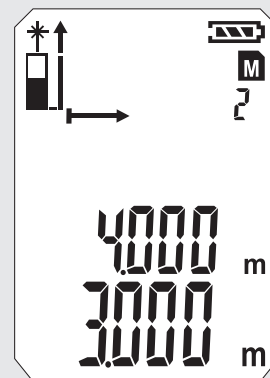
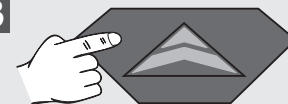

4

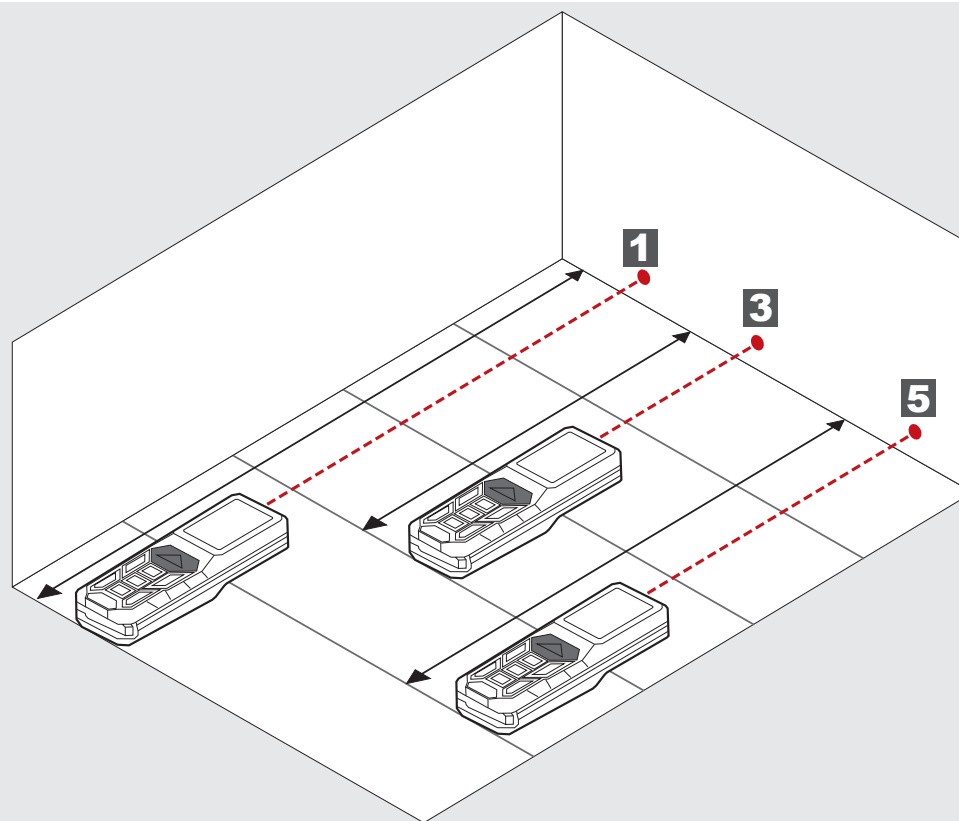
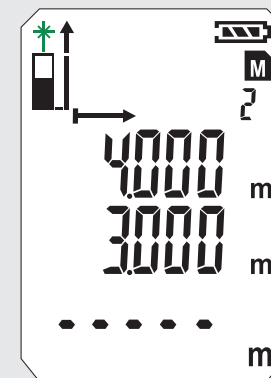
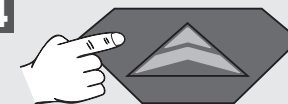

5

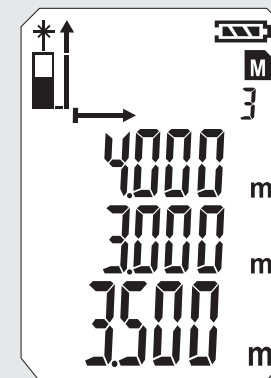
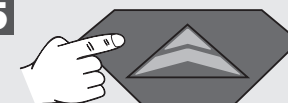

KONTINUIRANO MERJENJE / MERITEV MINIMUMA-MAKSIMUMA

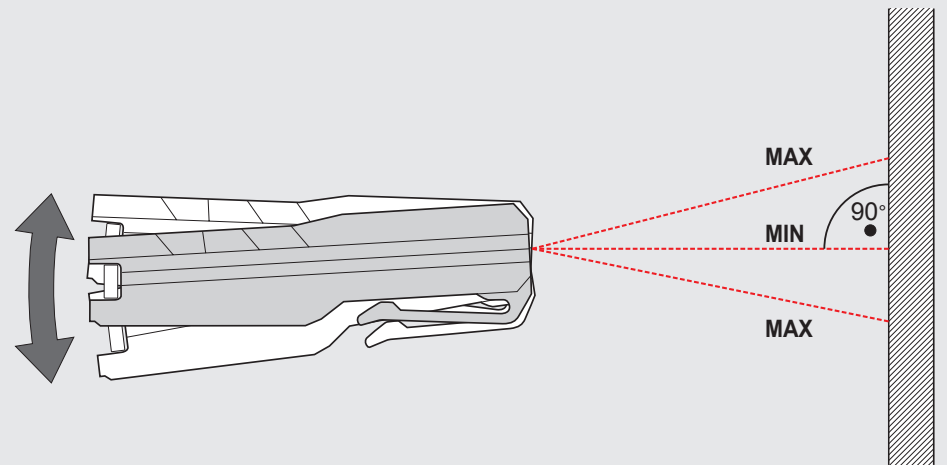
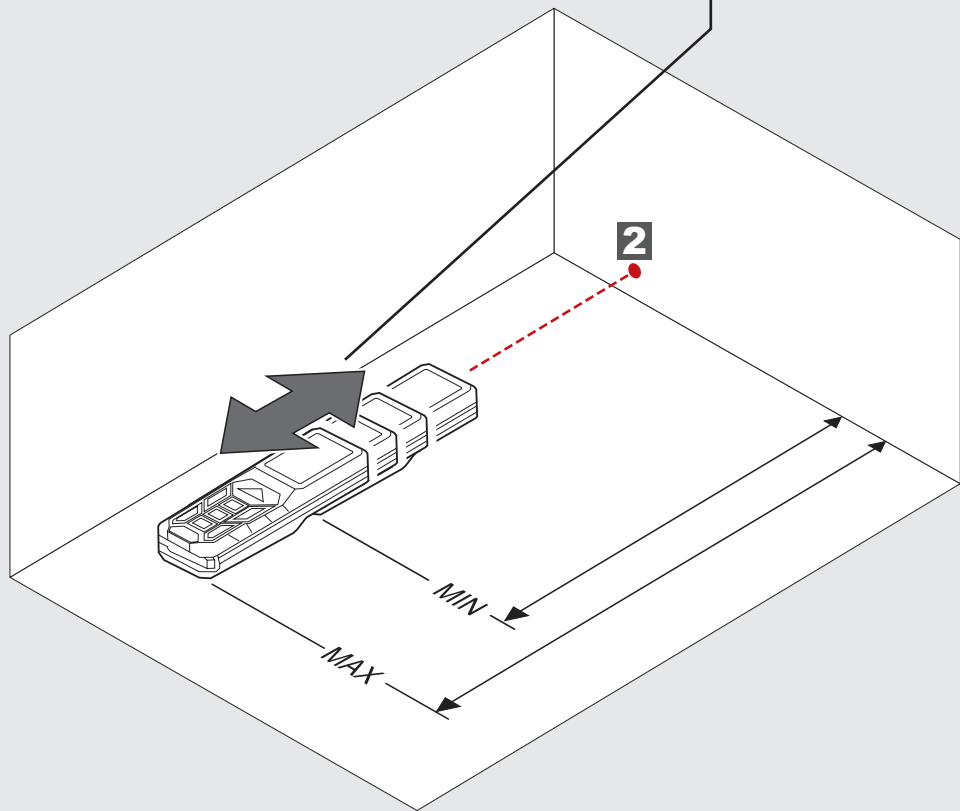
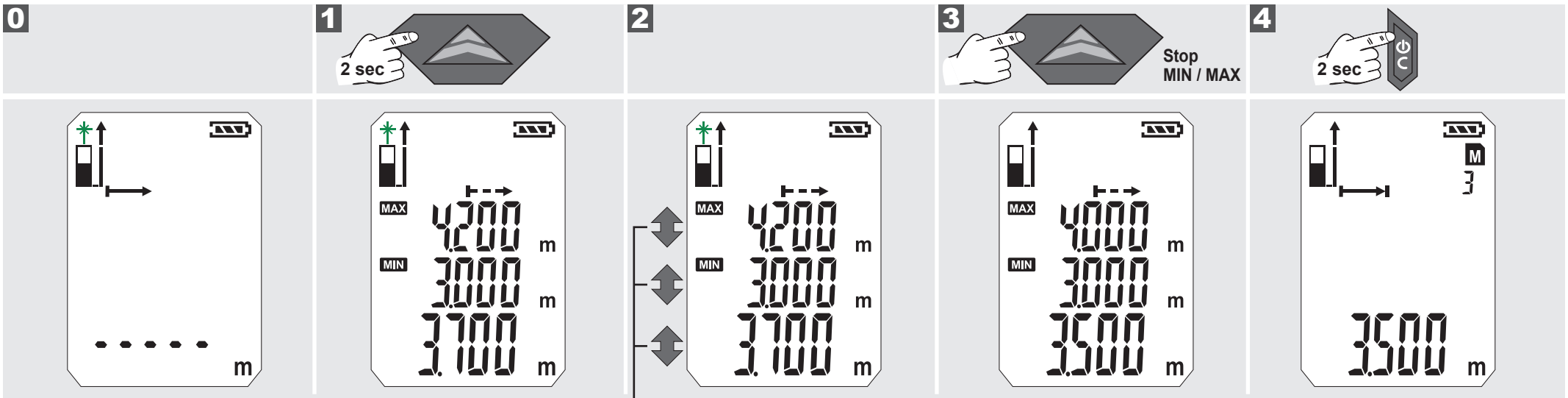

0

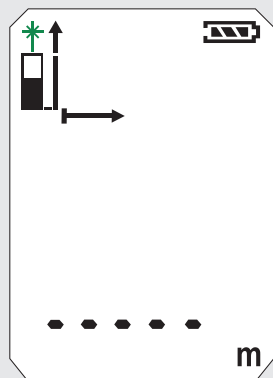

1

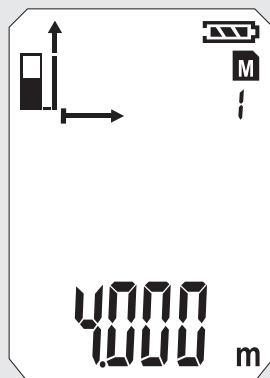
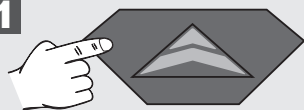

2

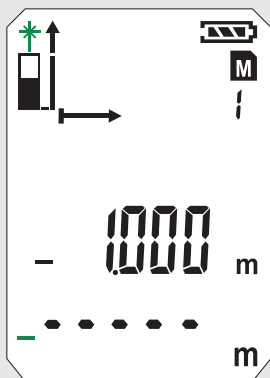

3

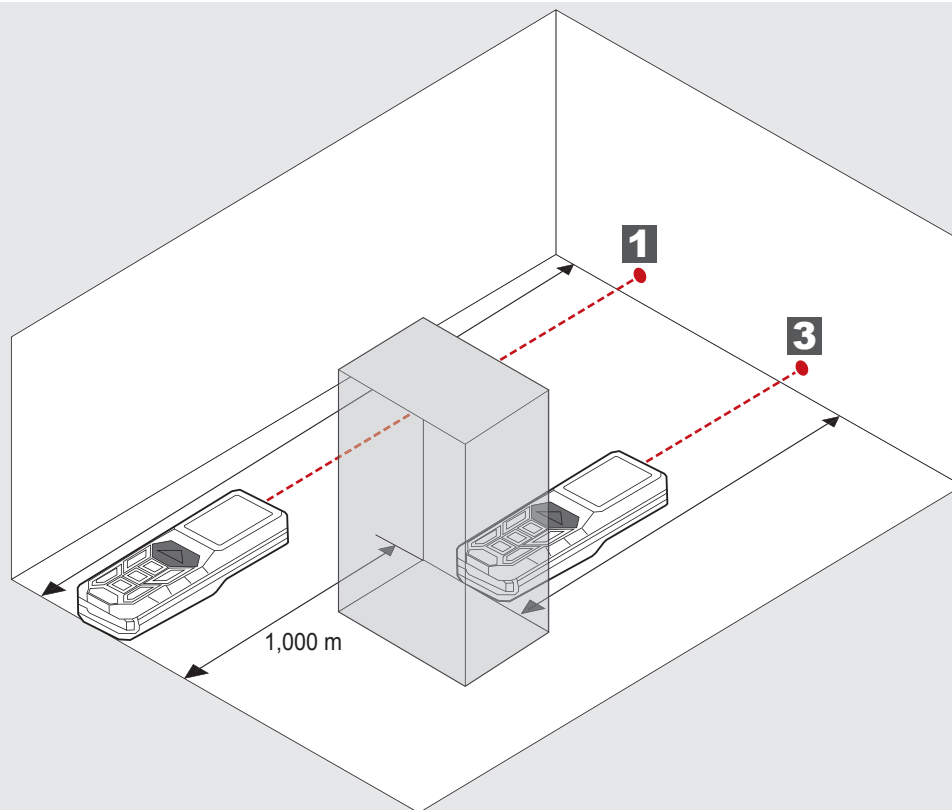
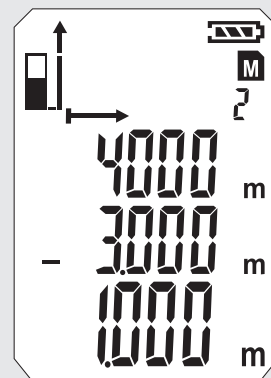
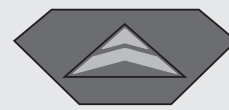

0



1

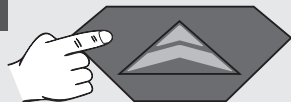

2

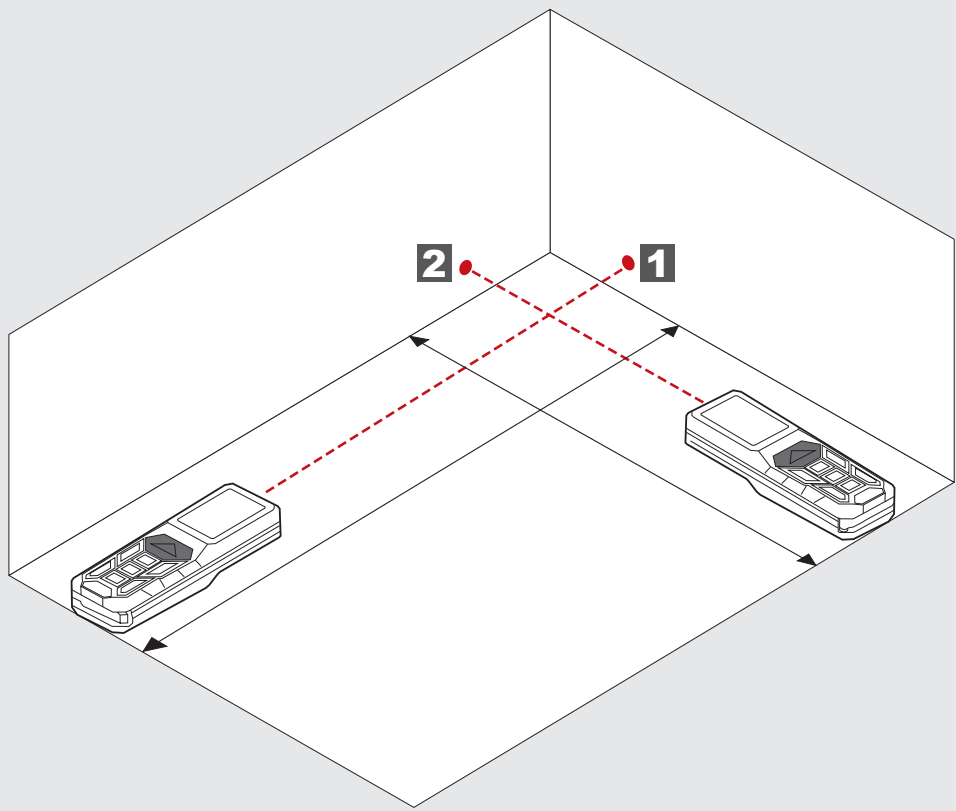
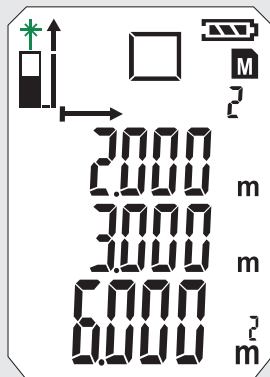
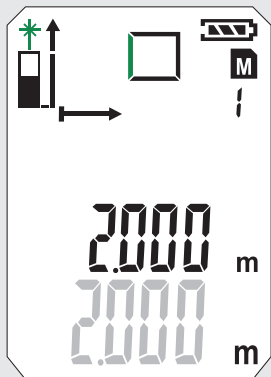
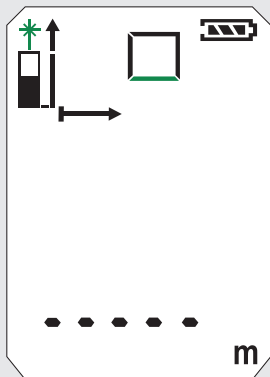
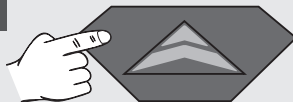

MERJENJE VOLUMNA

0



1

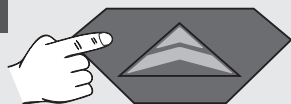

2

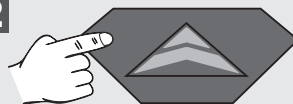

3

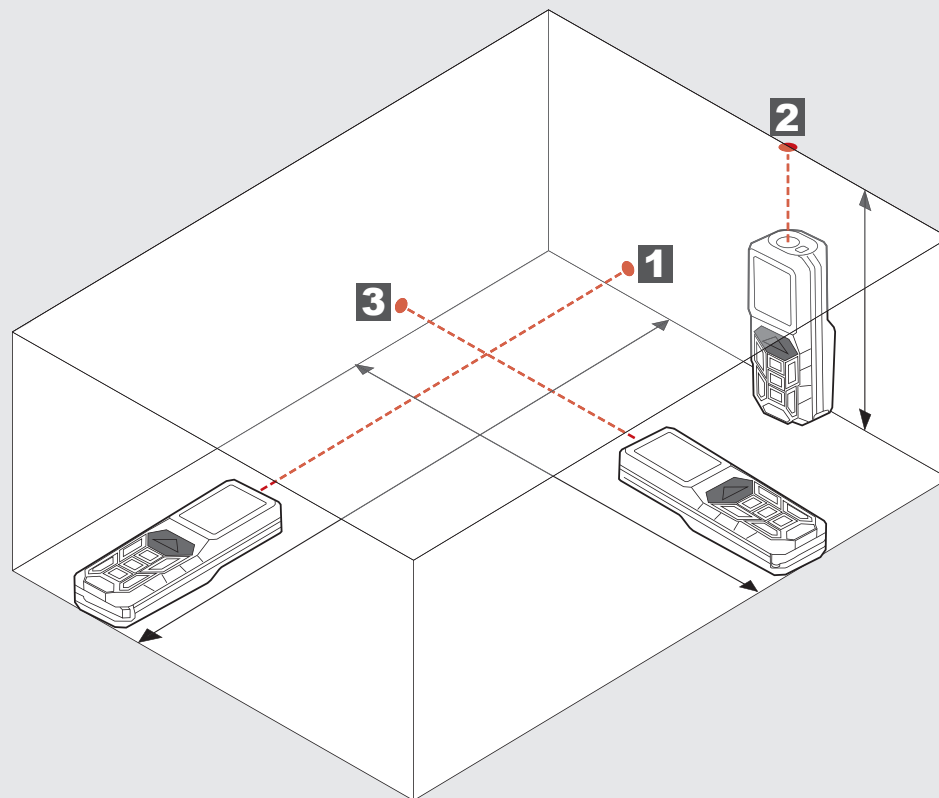
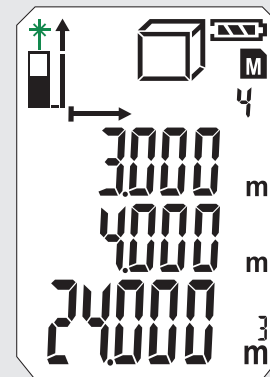
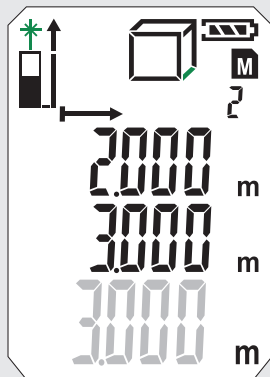
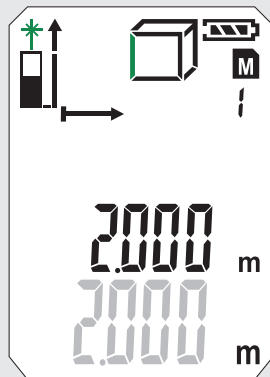
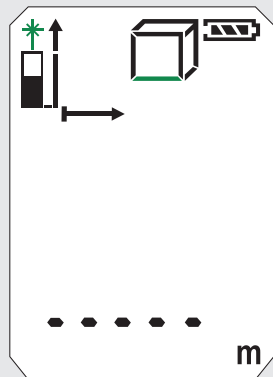
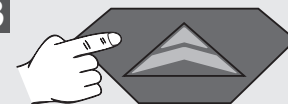

POSREDNA MERITEV (PITAGORA 1)

0



1

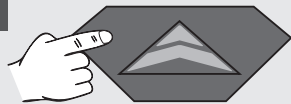

2

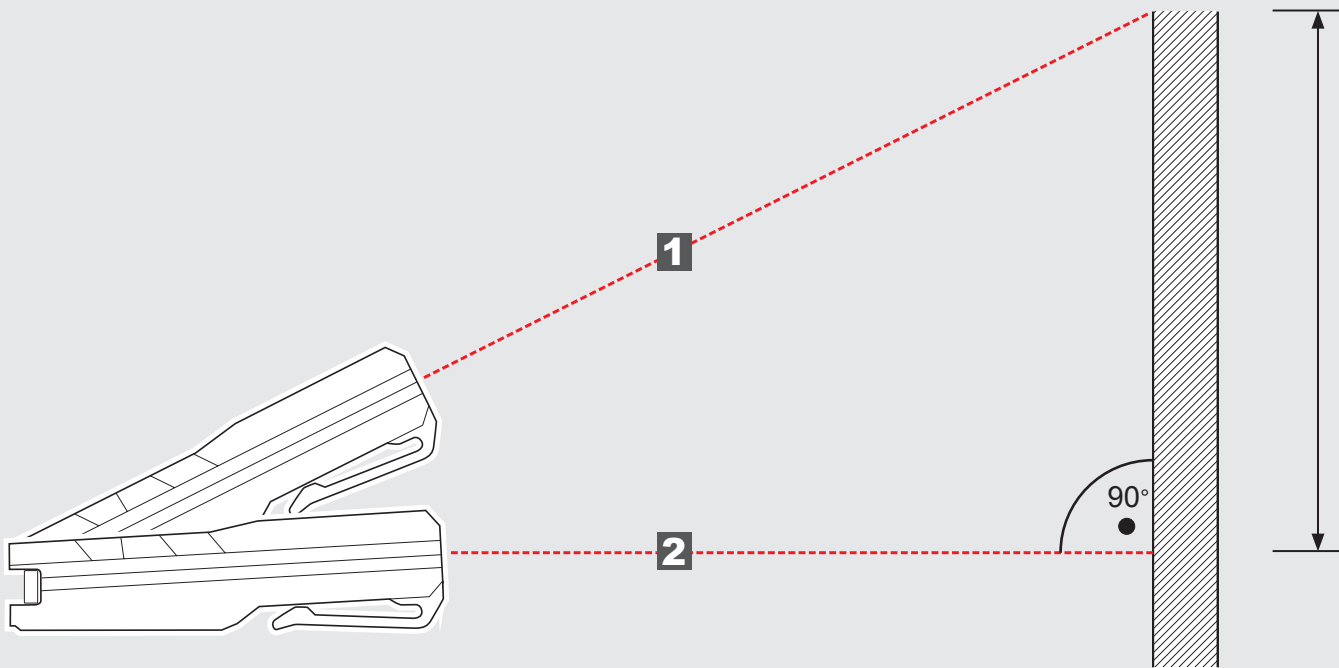
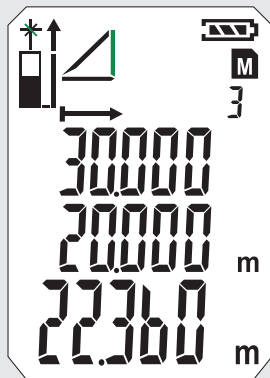
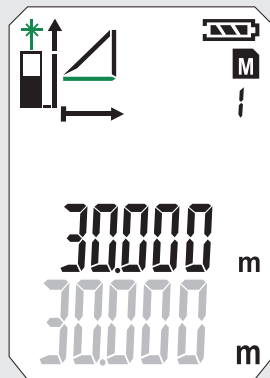
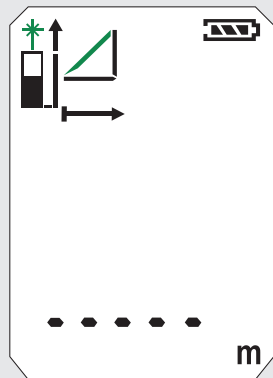
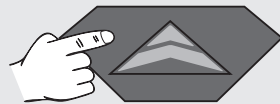

POSREDNA MERITEV (PITHAGORA 2)

0



1

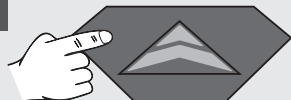

2



3

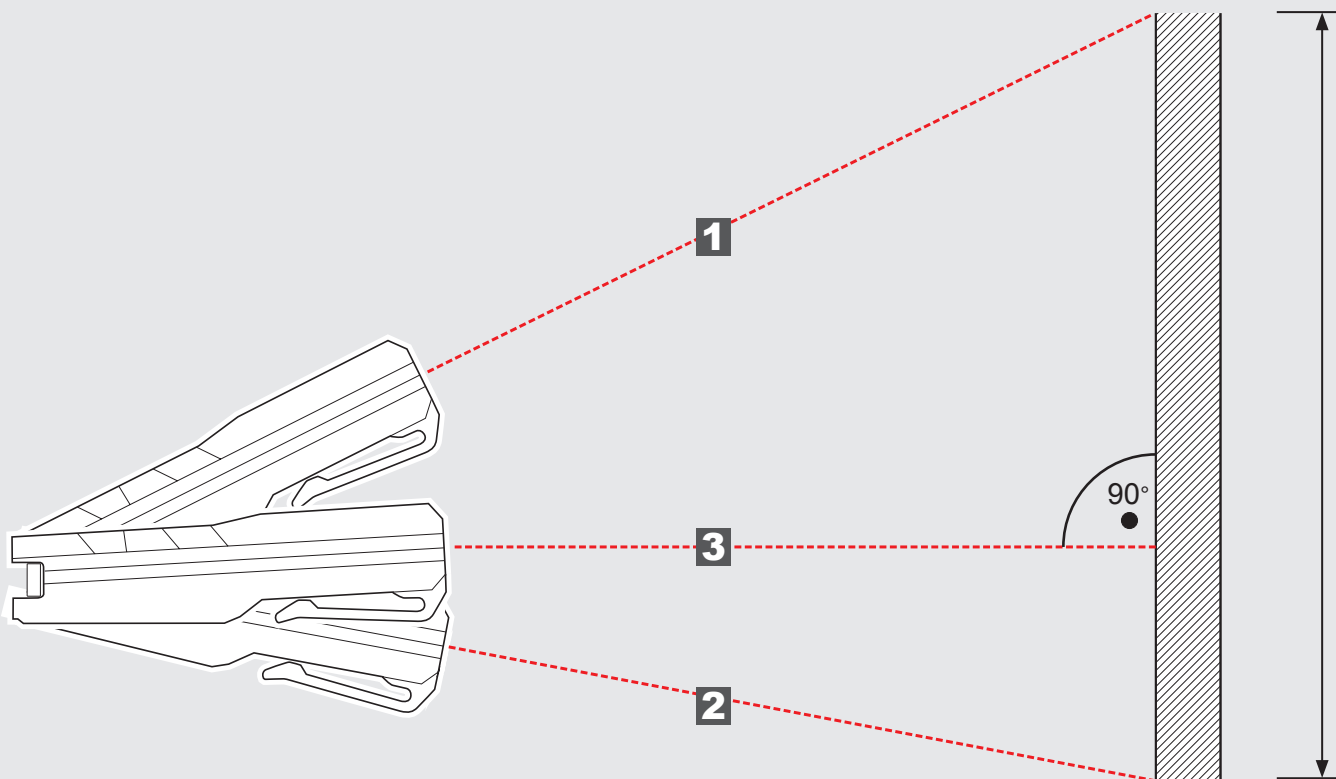
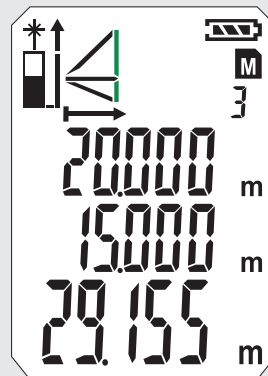
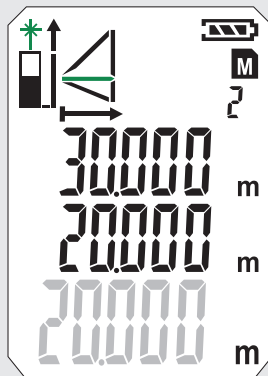
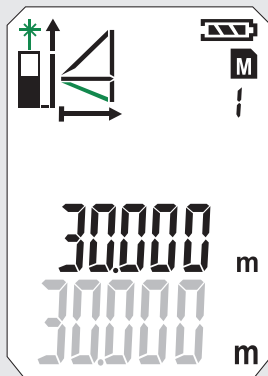
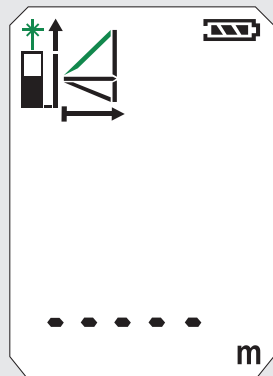

POSREDNA MERITEV (PITAGORA 3)

1



2

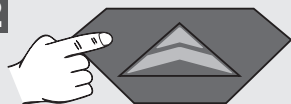

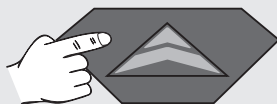

3

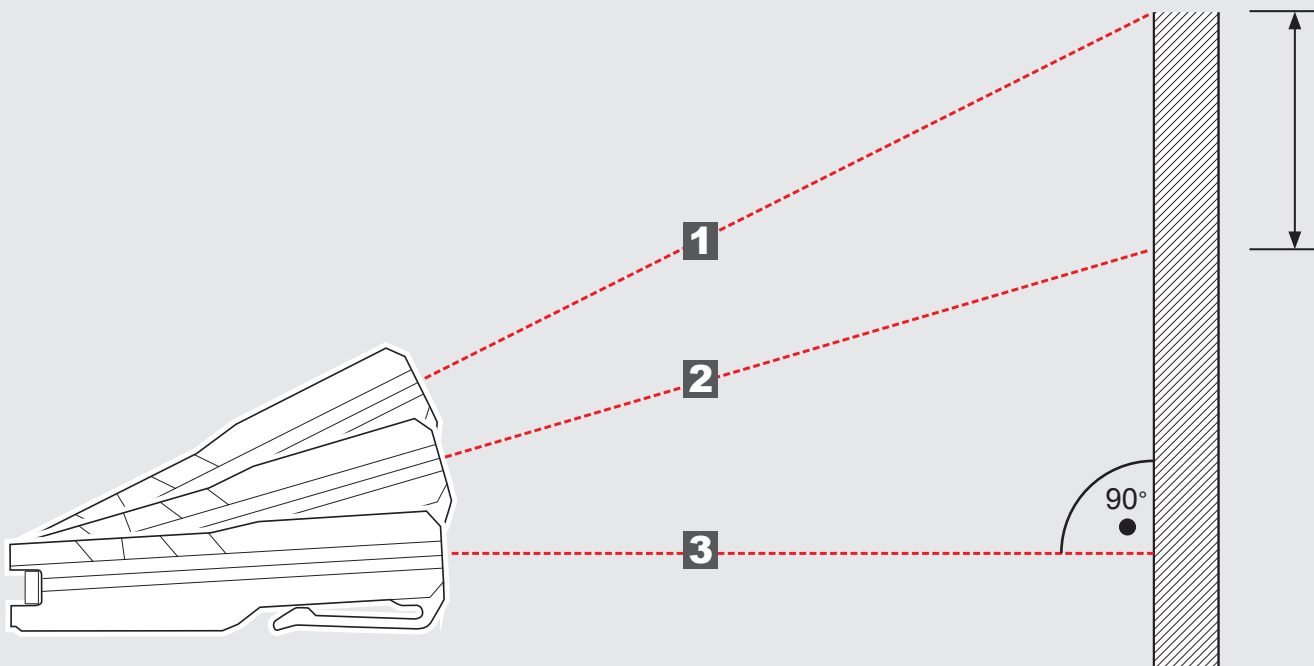
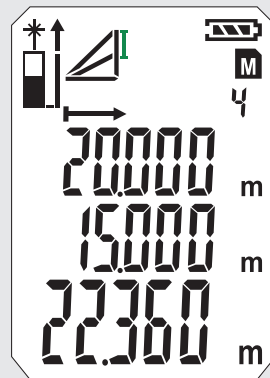
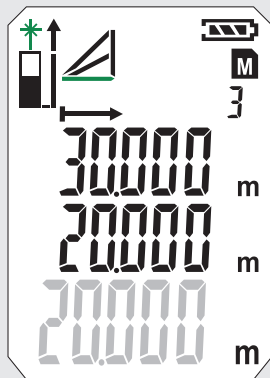
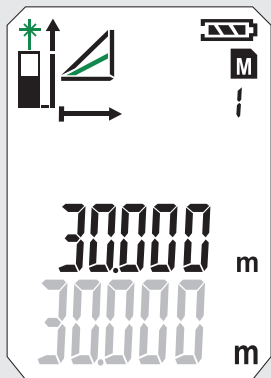
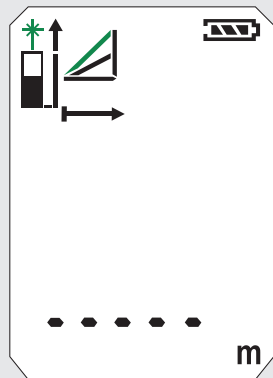

4

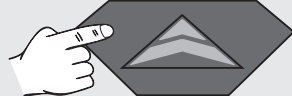
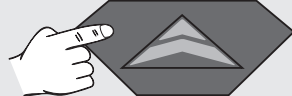
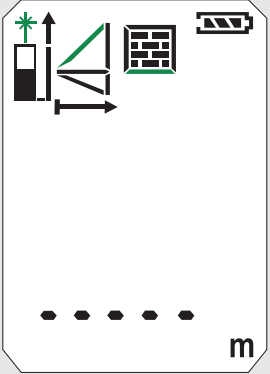
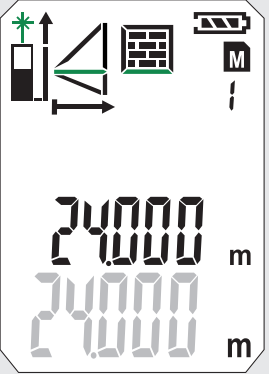
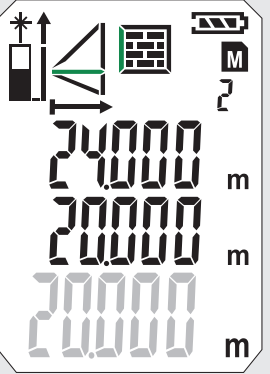
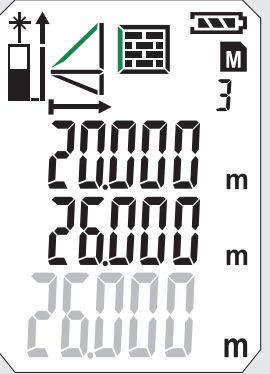
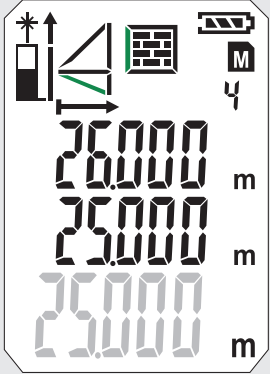

MERITEV ZIDNE POVRŠINE (SCENARIJ 1)

<p>0</p> 	<p>1</p> 	<p>2</p> 	<p>3</p> 	<p>4</p> 
				

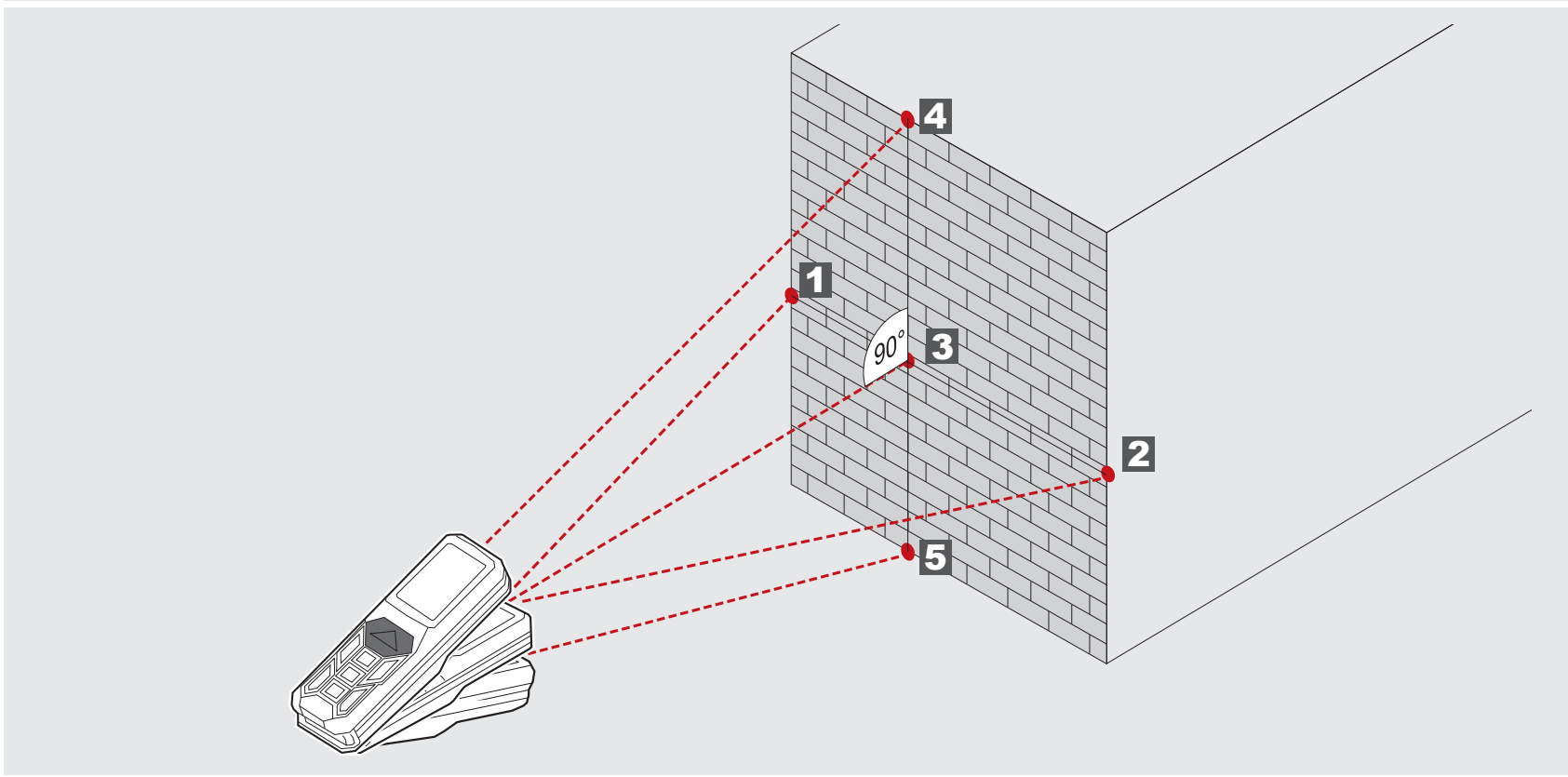





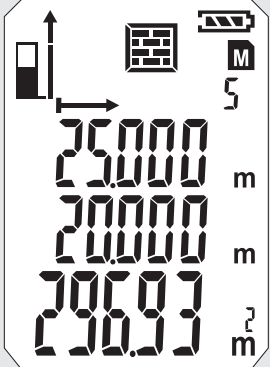









5



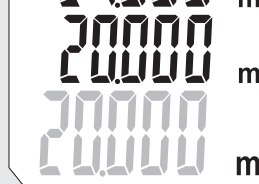

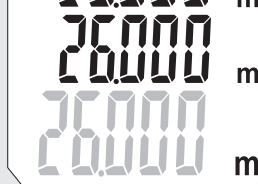
MERITEV ZIDNE POVRŠINE (SCENARIJ 2)

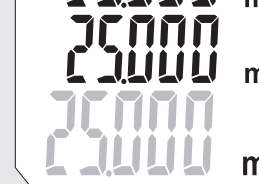
0 	1 	2 	3 	4 
 	 	 	 	 

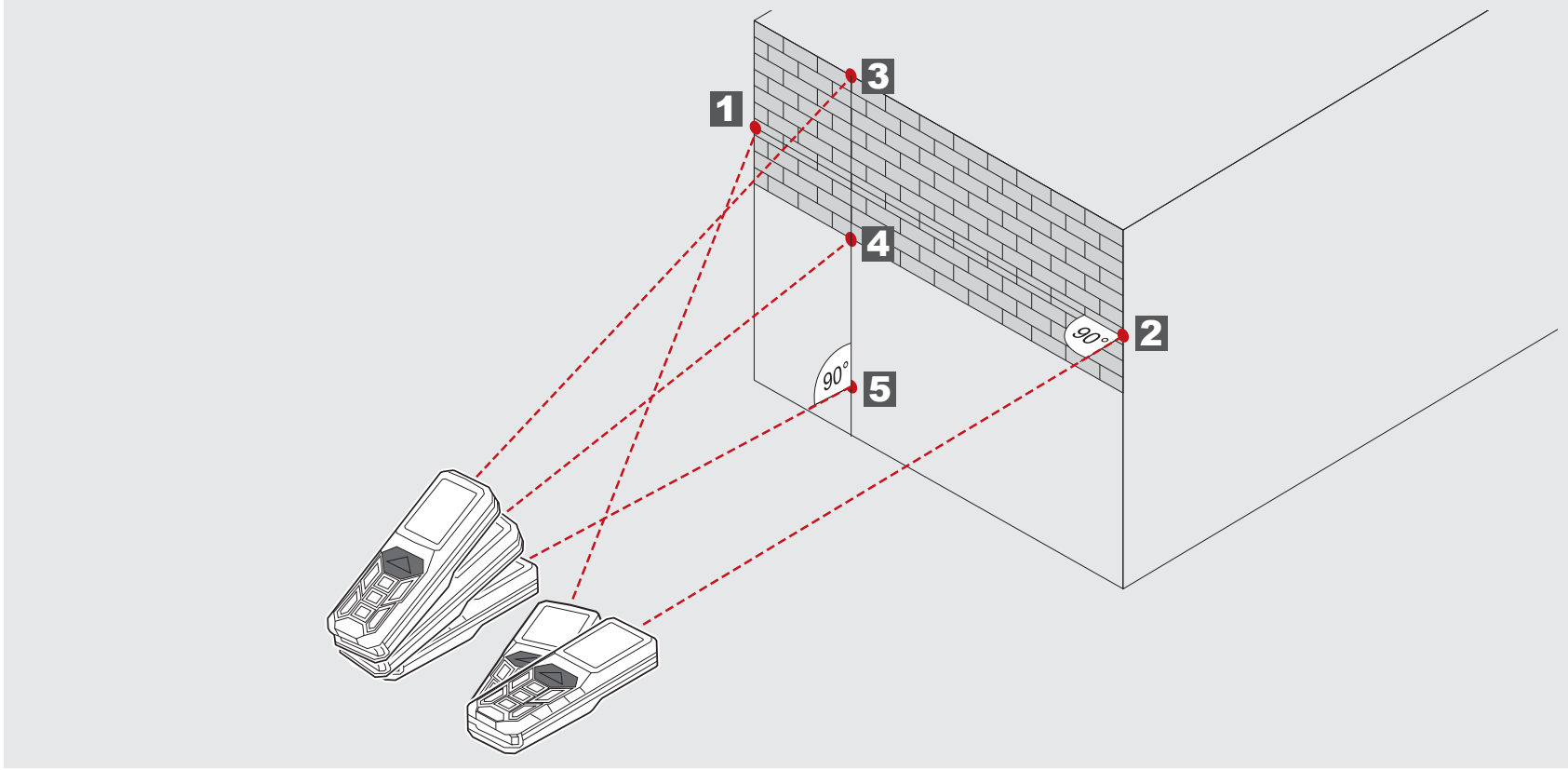

5



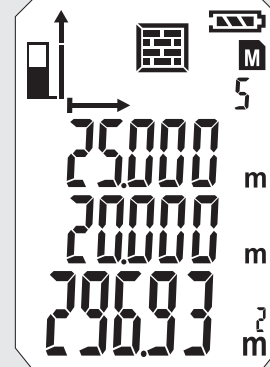

TIMER

S timer-jem lahko meritev zakasnite ali sprožite, da npr. komponento pozicionirate na merilnem žarku.

Pritisnite  tipko

- Simbol se prikaže
- S pritiskom tipke  lahko timer nastavite med 3 in 15 sekund.

Pritisnite  tipko

- Sekunde se odštevajo do meritve.
- Pri 0 se meritev sproži.

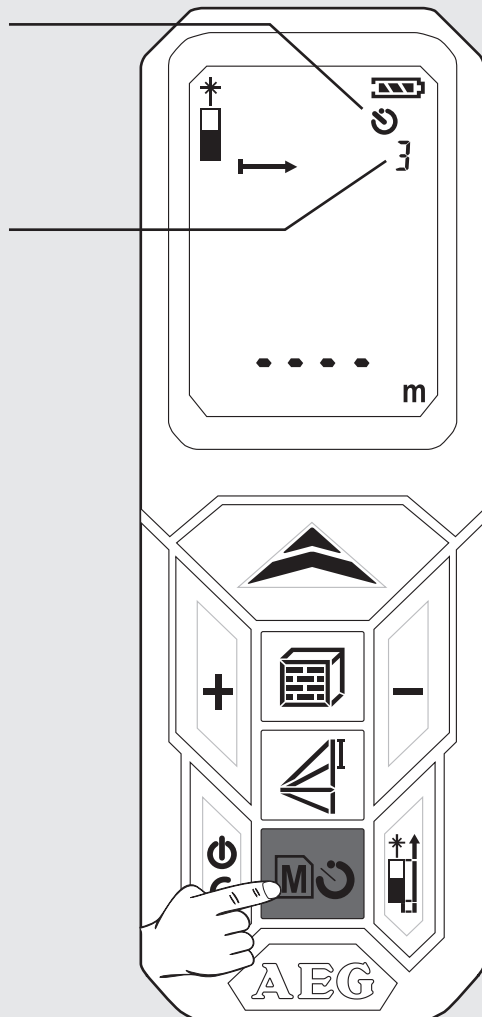

POMNILNIK

Merilne vrednosti se neprestano avtomatsko odlagajo v pomnilnik.

Shranjene vrednosti lahko s tipko  prikličete.

Pritisnitee  tipko 2 sekundi

- Simbol in mesto shranitve se prikažeta.
- Pripadajoča velikost meritve se prikaže.
- Shranjena vrednost se prikaže v glavni vrstici.
- S tipkama +/- navigirate

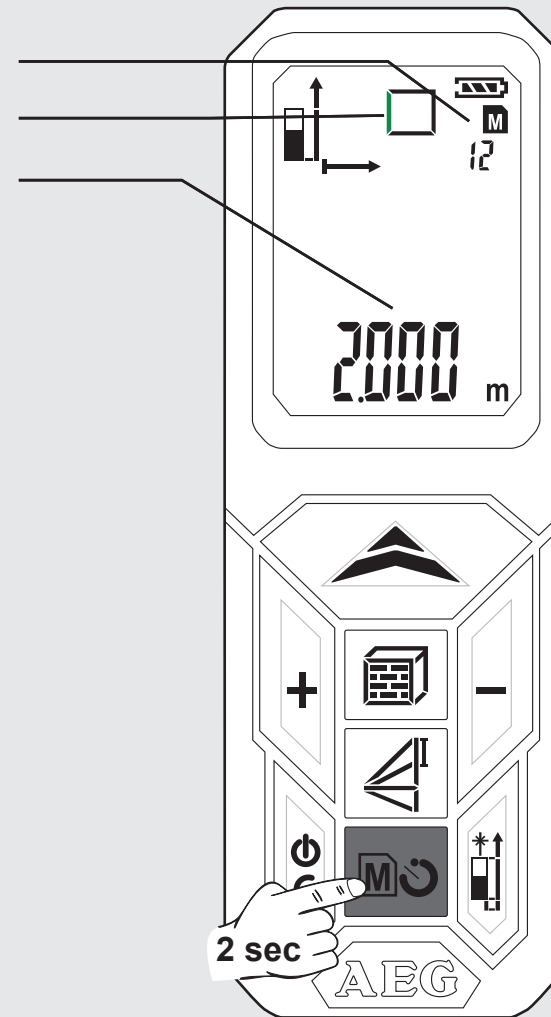

OSNOVNO DELOVANJE NA PRIMERU MERJENJA POVRŠINE (1)

1 Vklapljanje

Pritisnite  tipko.

⚠ Pozor! Laserski žarek je vklopljen!

Ne usmerjajte proti ljudem!

2 Izberi merilno ploskev

Standardna nastavitve po vklopu: zadaj

 pritisnite 1x -> kotni zatič

 pritisnite 2x -> spredaj

 pritisnite 3x -> zadaj

3 Izberi funkcijo

Po vklopu je naprava zmeraj v načinu merjenja dolžine.

 pritisnite 1x - merjenje površine

4 Merjenje dolžine

Napravo usmerite in pritisnite  tipko

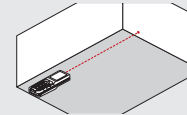

5 Meritev širine

Napravo usmerite in pritisnite  tipko

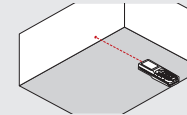

Simbol laserja utripa (utripanje je prikazano z zeleno).

Simbol je prikazan

- Simbol se prikaže
- Velikost meritve utripa (utripanje je prikazano z zeleno)

- Vrednost meritve se prikaže na kratko v glavni vrstici.
- Merilna vrednost preskoči po 1 sekundi v nad njo ležečo vrstico.
- Merilna vrednost se odloži v pomnilniku pod sledečo številko.
- Druga velikost meritve utripa.
- Naprava je pripravljena na meritev druge vrednosti.

- Merilna vrednost se prikaže na kratko v glavni vrstici.
- Merilna vrednost preskoči po 1 sekundi v nad njo ležečo vrstico.
- Merilna vrednost se odloži v pomnilniku pod sledečo številko.
- Izid se prikaže v glavni vrstici in se odloži v pomnilniku pod sledečo številko.

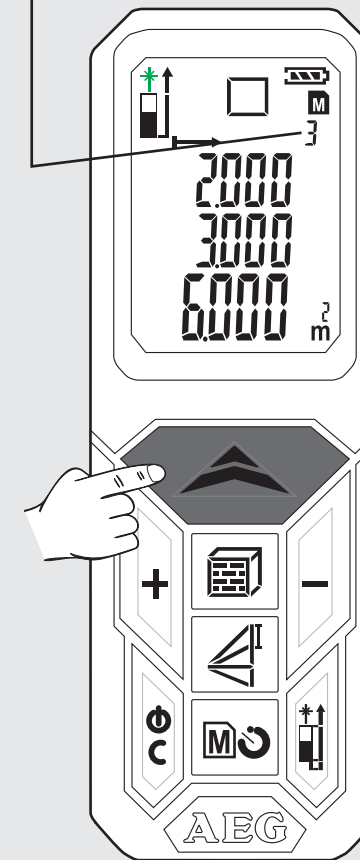
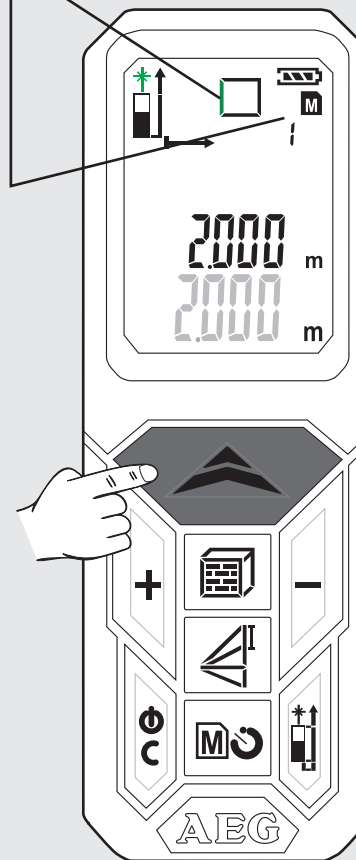
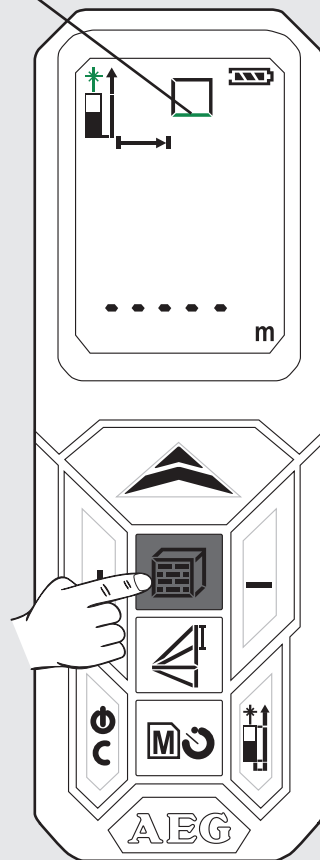
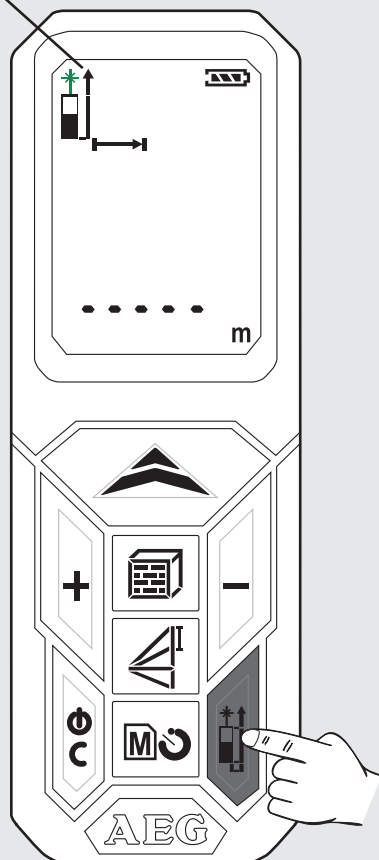
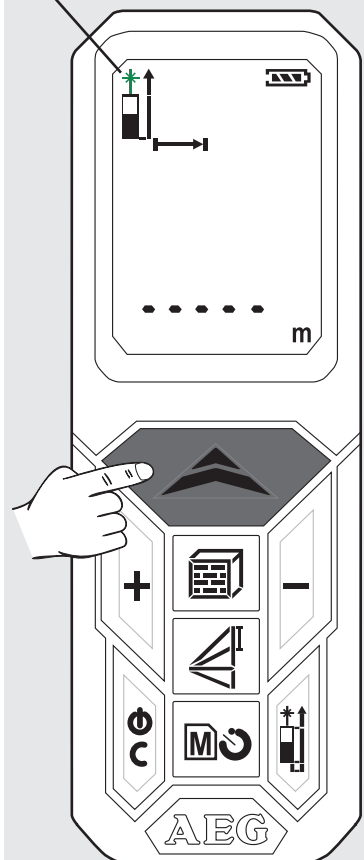

OSNOVNO DELOVANJE NA PRIMERU MERJENJA POVRŠINE (2)

6 prikliv shranjenih vrednosti

Pritisnite  tipko 2 sekundi.

Pritisnite tipko + ali -

7 Zapusti pomnilnik

Pritisni  tipko

8 Izklapljanje

Pritisnite  tipko 2 sekundi
(Pomnilnik je poprej treba zapustiti).

- Shanjene vrednosti se prikažejo v glavni vrstici.

- Pripadajoč simbol se prikaže in velikost meritve utripa (utripanje je prikazano z zeleno).

- Naprava se izklopi.

- V kolikor 3 minute ne pritisnemo nobene tipke, se naprava avtomatsko izklopi.

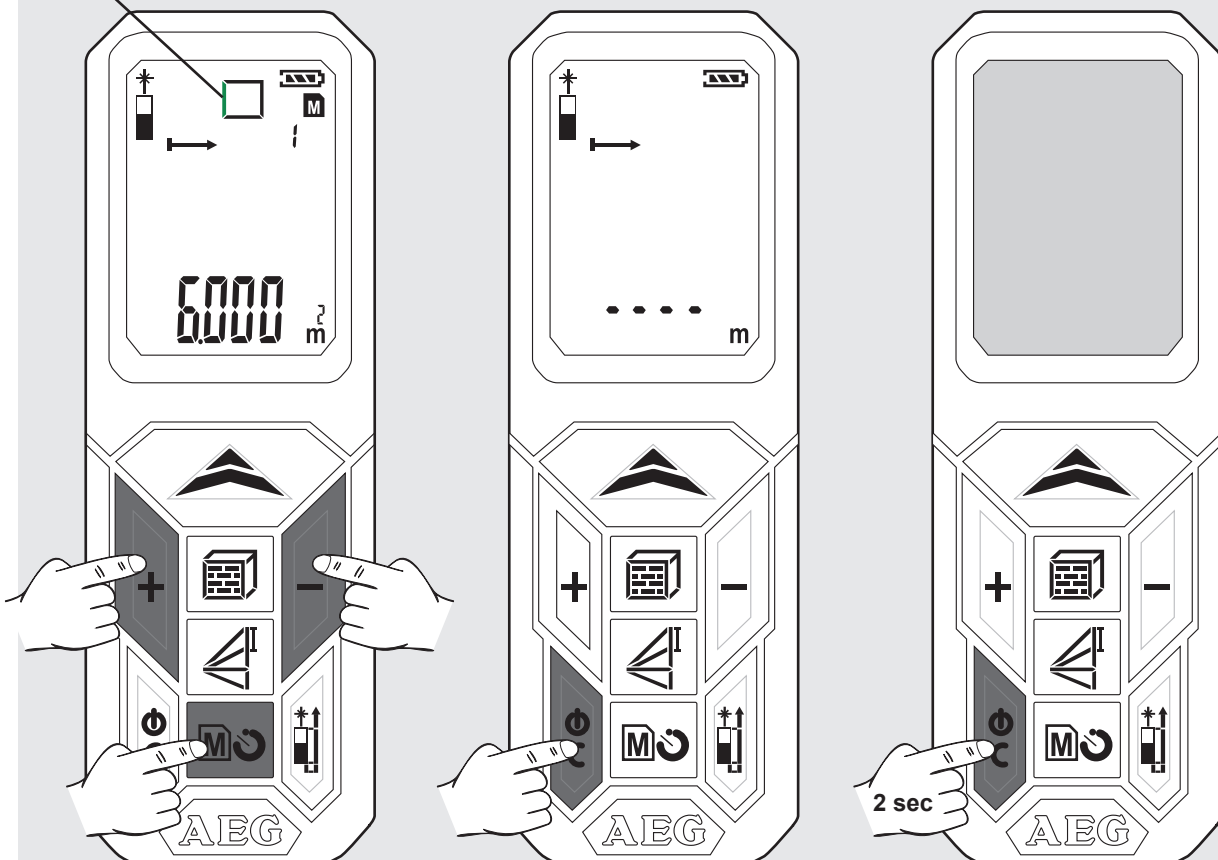

SADRŽAJ

Važne upute o sigurnosti	1
Tehnički podaci	2
Propisna upotreba	2
Tabela kodova pogreške.....	2
Pregled	3
Promijeniti bateriju	4
Kutni zatik	4
Držač pojasa.....	4
Tipka finkcije, Pitagora, mjerna ravnina.....	5
Jednostavno mjerenje duljine	6
Kontinuirano mjerenje / Mjerenje Minimum-Maximum	7
Mjerenje zbrajanja / oduzimanja	8
Mjerenje površine	9
Mjerenje volumena	10
Indirekno mjerenje (Pitagora 1)	11
Indirekno mjerenje (Pitagora 2)	12
Indirekno mjerenje (Pitagora 3)	13
Mjerenje zidne površine (Scenario 1).....	14
Mjerenje zidne površine (Scenario 2).....	15
Timer	16
Memorija.....	16
Temeljiti način funkcije na primjeru jednog mjerenja površine (1).....	17
Temeljiti način funkcije na primjeru jednog mjerenja površine (2).....	18

VAŽNE UPUTE O SIGURNOSTI



Ne koristite proizvod prije nego što proučite upute o sigurnosti te korisnički priručnik na priloženom CD-u.

Klasifikacija lasera

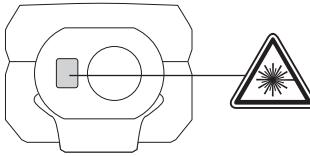

UPOZORENJE:

Ovo je laserski proizvod **klase 2** u skladu s IEC 60825-1:2007.



Natpis

Oblijepite engleski tekst na pločici snage prije prvotnog puštanja u rad sa suisporučenom naljepnicom na Vašem jeziku.

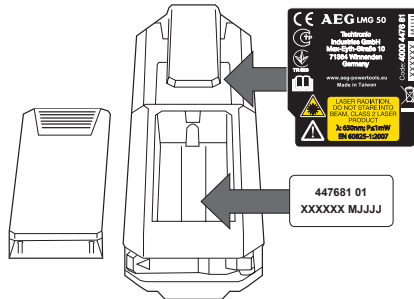

Pozor:

Izbjegavajte direktni kontakt sa očima. Laserska zraka može zabljesnuti oči i nakratko dovesti do zasljepljenja.

Ne zurate u lasersku zraku i ne upravljajte je bespotrebno prema drugim ljudima.

Ne bljeskajte prema drugim osobama.

Upozorenje:

Ovaj laserski uređaj ne poganjati u blizini djece i djeci ne dozvoliti da koriste ovaj laserski uređaj.

Pažnja! Jedna reflektirajuća površina bi lasersku zraku mogla reflektirati nazad na poslužioca i druge osobe.

Ekstremite držite na sigurnoj udaljenosti od pomičnih dijelova.

Provedite povremena probna mjerenja. Posebno prije, tijekom i nakon važnih mjerenja.

Ako je proizvod oštećen, ako je pao ili ako je neispravno korišten i mijenjan, pratite postoje li pogrešna mjerenja.

Pažnja! Upoznajte se sa elementima posluživanja i propisnom uporabom vrtnog uređaja.

Laserski mjerni instrument ima ograničeno područje uporabe. (vidi odsječak "Tehnički podaci"). Probe, mjeriti izvan maksimalnog i minimalnog područja, uzrokuju netočnosti. Uporaba pod lošim uvjetima, kao što je prevruće, prehladno, sunčeva svjetlost, kiša, snijeg, magla ili drugi uvjeti koji ograničavaju vidljivost, mogu voditi do netočnih mjerenja.

Ako se laserski mjerni instrument iz tople sredine prenosi u hladnu sredinu (ili obrnuto), pričekajte da se uređaj uskladi na novu temperaturu sredine.

Laserski mjerni instrument čuvati uvijek unutar prostorija i štiti protiv potresa, vibracija i ekstremnih temperatura.

Laserski mjerni instrument štiti od prašine, vlage i visoke vlage zraka. To može uništiti unutarnje elemente i utjecati na točnost.

Nemojte koristiti nikakva agresivna sredstva za čišćenje ili otapala. Čistiti samo jedno čistom mekom krpom.

Izbjegavajte snažne udarce po instrumentu i padove laserskog uređaja. Točnost uređaja se mora provjeravati ako je pao na pod ili ako je bio izložen drugim mehaničkim opterećenjima.

Potrebne popravke na ovom laserskom uređaju smije izvoditi samo autorizirano stručno osoblje.

Proizvodom ne upravljajte u područjima u kojima postoji opasnost od eksplozije ili u agresivnim okolinama.

Koristite samo punjače koje je preporučio proizvođač za punjenje baterija.

 Prazne baterije se ne smiju odstraniti skupa sa kućnim smećem. Rabljene baterije dati na zbrinjavanje odgovarajuće okolici prema nacionalnim ili lokalnim propisima na predviđena mjesta skupljanja. Aparat se ne smije zbrinuti sa kućnim smećem. Aparat zbrinuti na stručan način. Poštivati propise zbrinjavanja specifične za dotičnu državu. Obratite se mjesnim vlastims ili trgovcu u svezi informacija o zbrinjavanju.

 Oznaka-CE

TEHNIČKI PODACI

Zaštitna klasa	IP54 (zaštićen protiv prašine i štrcajuće vode)
Optika	14 mm
Žarište	35 mm
Mjerno područje max.	50 metara (Tolerancija: 55m)
Mjerno područje min.	0,05 metara
Apsolutna točnost @ < 10m	± 1,5 mm (Max)
Ponovljena točnost @ < 10m	± 1,5 mm (tipično max. 2σ)
Ponovljena točnost @ > 10m	Porast ± 0,25 mm / metar (tipično max. 2σ)
Mjerno vrijeme	0,5 s
Display tip	LCD (22,7 mm x 31 mm)
Opskrba strujom	AAA 2x (Alkaline baterija)
Rok trajanja baterije	10000 (pojedinačno mjerenje)
Izlazna snaga lasera	0,6 mW ~ 0,95 mW (Class 2, 650nm)
Veličina laserske točke	25 x 30 mm @ 16 m (Max)
Laserska zraka okomiti kut	+1 stupanj
Laserska zraka vodoravni kut	±1 stupanj
Automasko isklapanje instrumenta	180 sekunda
Automatsko isklapanja lasera	30 sekunda
Područje radne temperature	-10°C do +50°C
Područje temperature ležaja	-25°C to +70°C
Težina bez baterije	80 g

PROPISNA UPOTREBA

Laserski instrument je prikladan za mjerenje distancija i nagiba.

Ovaj aparat se smije upotrijebiti samo u određene svrhe kao što je navedeno.

TABELA KODOVA POGREŠKE

Kod	Opis	Rješenje
Err01	Izvana mjernog područja	Mjerenje sprovesti u predviđenom području.
Err02	Reflektirani signal je preslab	Odabрати jednu bolju površinu.
Err03	Izvan područja pokazivanja (max. vrijednost: 99.999) npr. ako je rezultat ili volumen izvan područja pokazivanja	provjeriti da li su vrijednost i koraci korektni.
Err04	Pogreška u Pitagora proračunur	Provjeriti da li su vrijednosti i koraci korektni.
Err05	Baterija slaba	Umetnuti nove baterije.
Err06	Izvan područja radne temperature	Izvesti mjerenje na zadanom području radne temperature.
Err07	Svjetlo okoline presvjetlo	Ciljno područje potamniti.

Pitagorova visinska razlika

Mjerna ravnina

Mjerenje duljine

Minimum / Maximum za kontinuirano mjerenje

Zbrajanje / Oduzimanje

UKLJUČI / MJERITI

- ▶ Uključi
- ▶ Mjeriti
- ▶ Kontinuirano mjerenje (2 sek. pritisnati)
Min. / Max. Funktion

ZBRAJANJE

- ▶ Zbrojiti vrijednost
- ▶ Navigiranje u memoriji

POVRŠINA / VOLUMEN

- ▶ Površina (1x pritisnuti)
- ▶ Volumen (2x pritisnut)
- ▶ Indirektno mjerenje površine (3x / 4x pritisnuti)

UKLJUČITI

- ▶ Uključeno
- ▶ Isključeno (2 sek. pritisnati)
- ▶ Vratiti

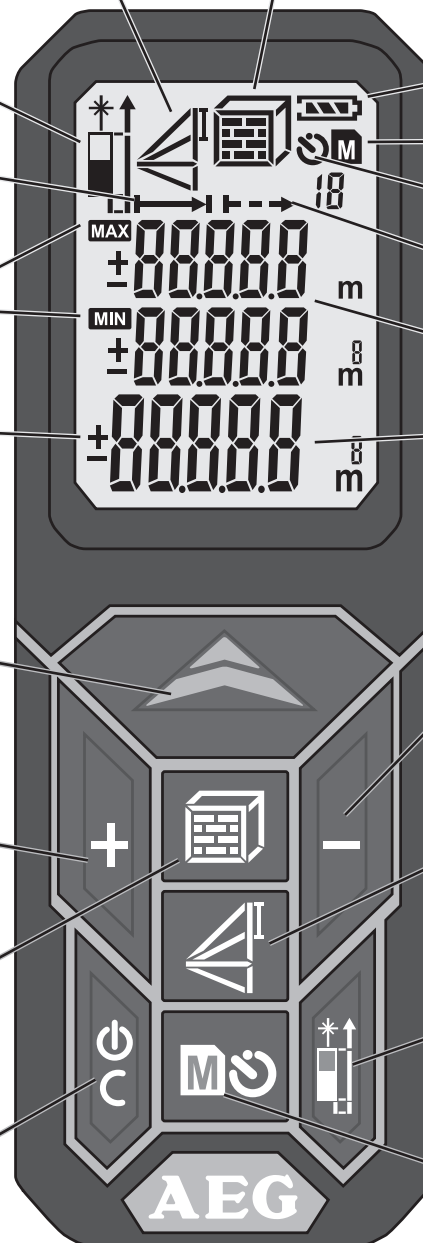

Površina / Volumen
Indirektno mjerenje površine

Status baterije

Memorija

Timer

Kontinuirano mjerenje

Međuvrijednosti

Ukupna vrijednost

ODUZIMANJE

- ▶ Vrijednost oduzeti
- ▶ Navigirati u memoriji

PITAGORA

- ▶ Pitagora 1 (1x pritisnuti)
- ▶ Pitagora 2 (2x pritisnuti)
- ▶ Pitagora 3 (3x pritisnuti)

MJERNU RAVNINU PROMIJENITI

- ▶ Sprijeda
- ▶ Odzada
- ▶ Kutni zatik

MEMORIJA

- ▶ Timer 3-15 sek. (1x pritisnuti)
- ▶ Memorija 1-20 (1x 2 sek. pritisnuti)
- ▶ Sa tipkama +/- navigirati u memoriji

PROMIJENITI BATERIJU

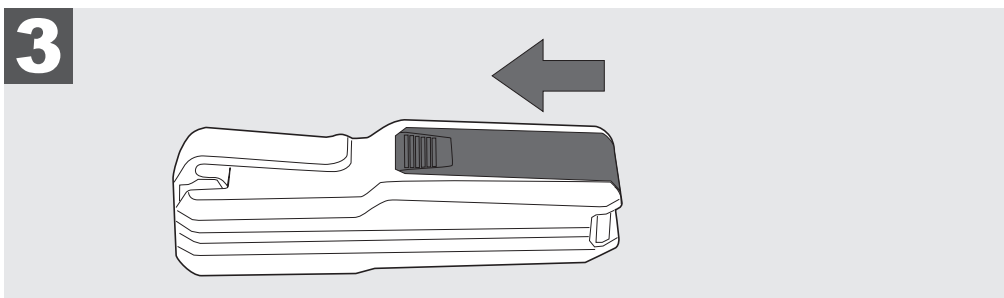
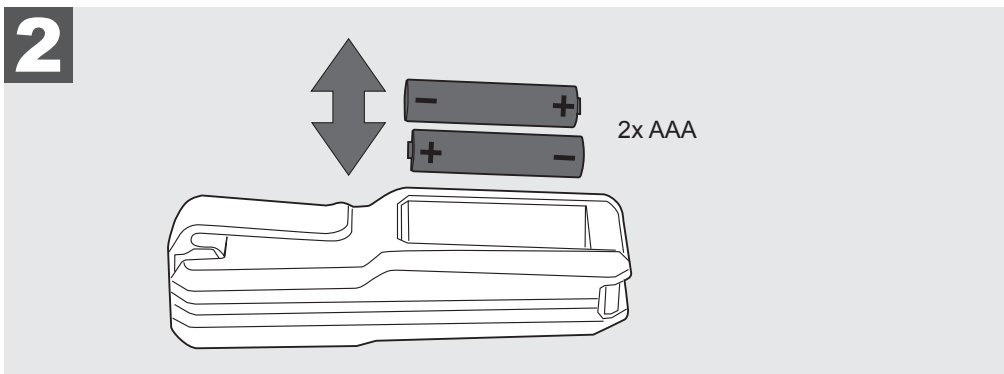
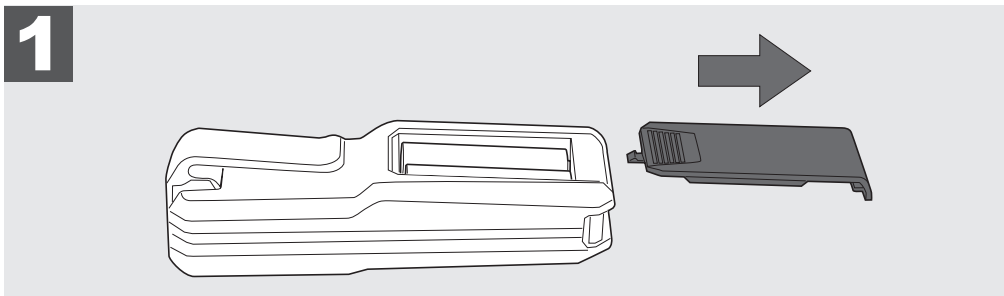
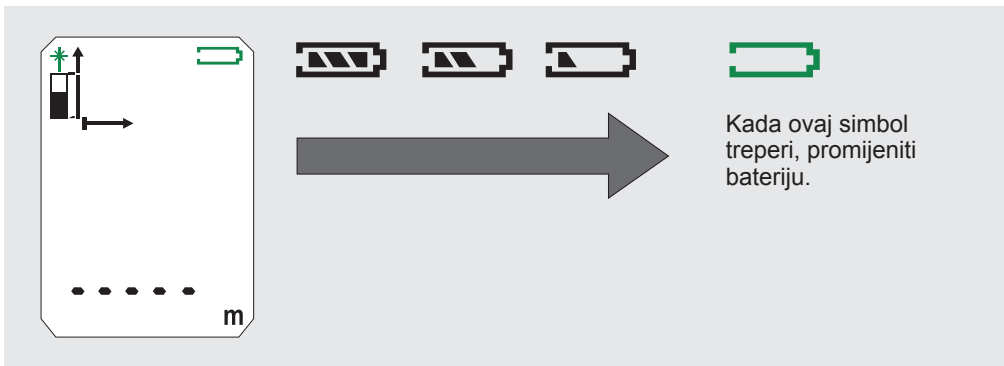

KUTNI ZATIK

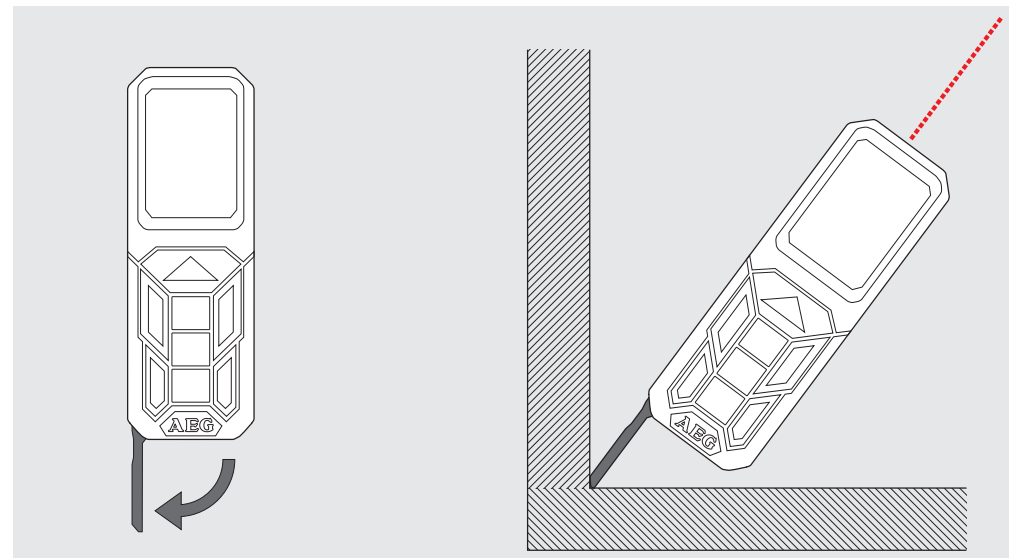

DRŽAČ POJASA

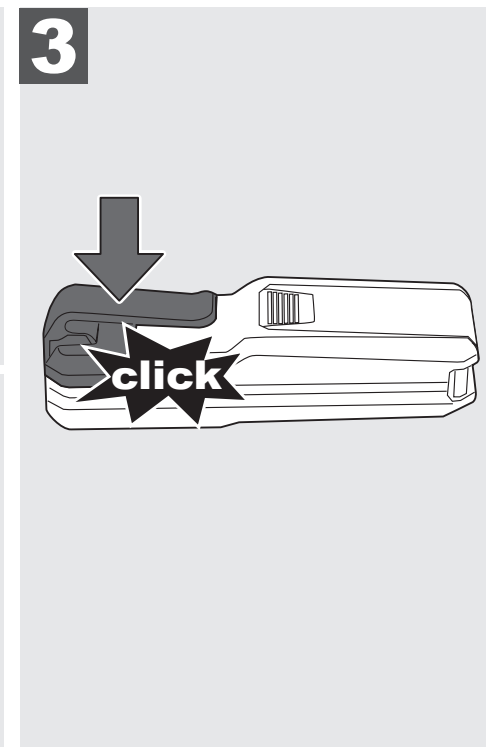
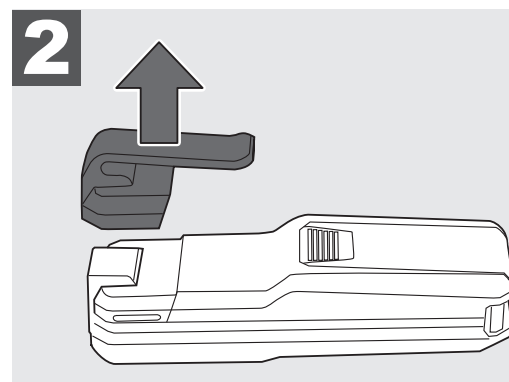
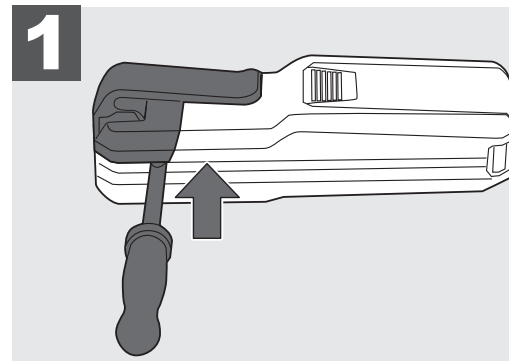

TIPKA FUNKCIJE, PITAGORA, MJERNA RAVNINA

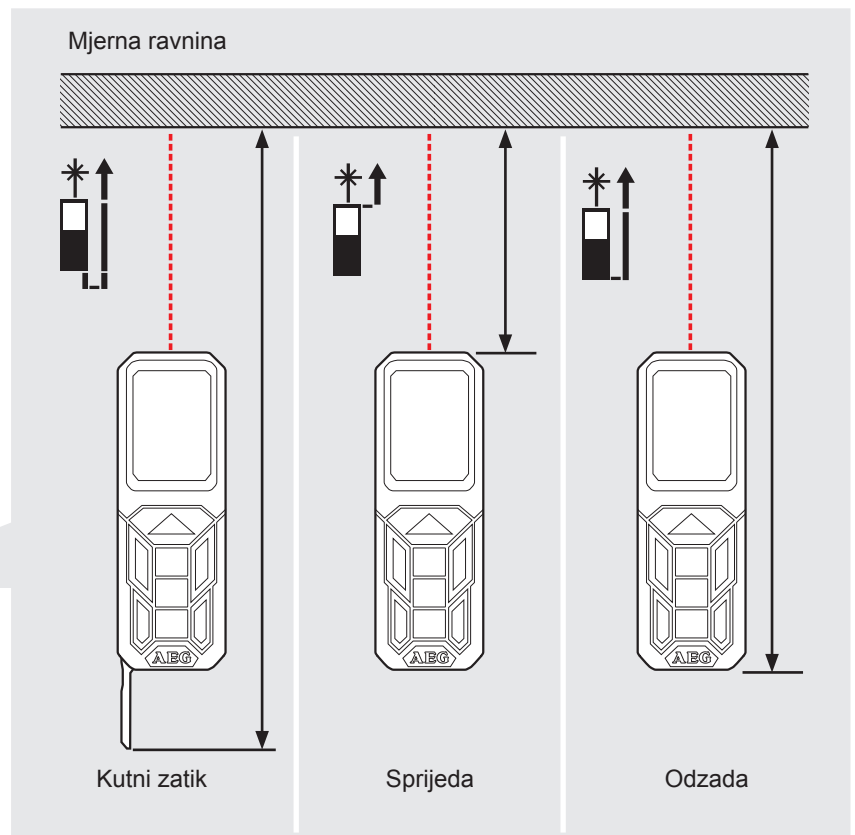
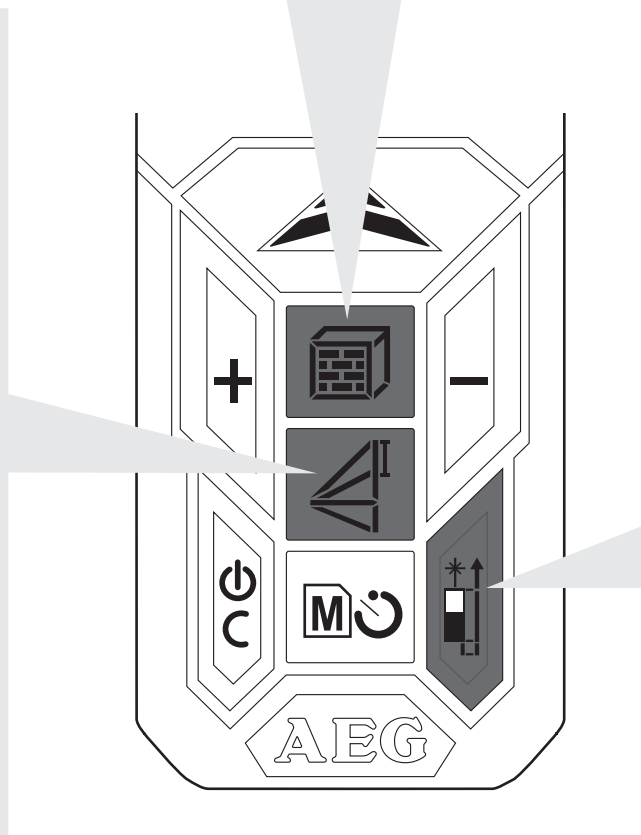
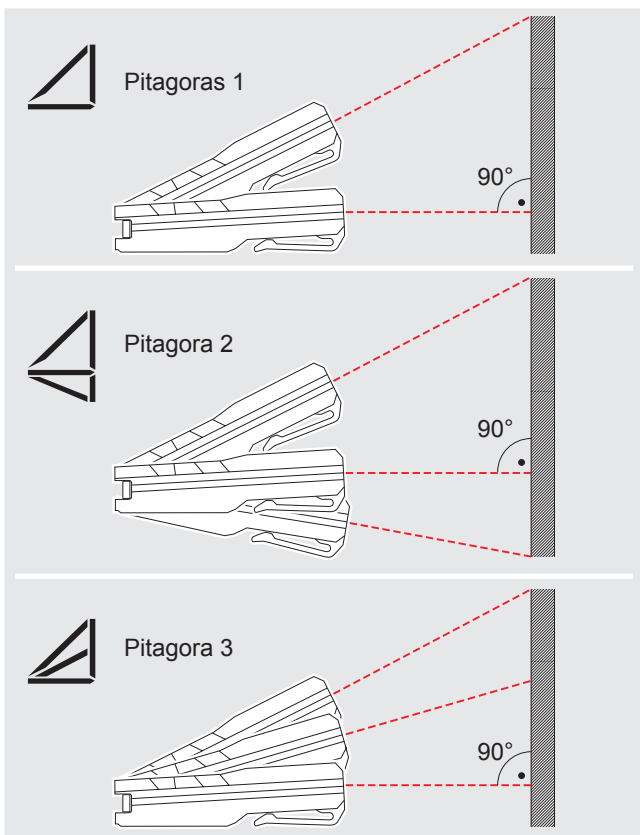
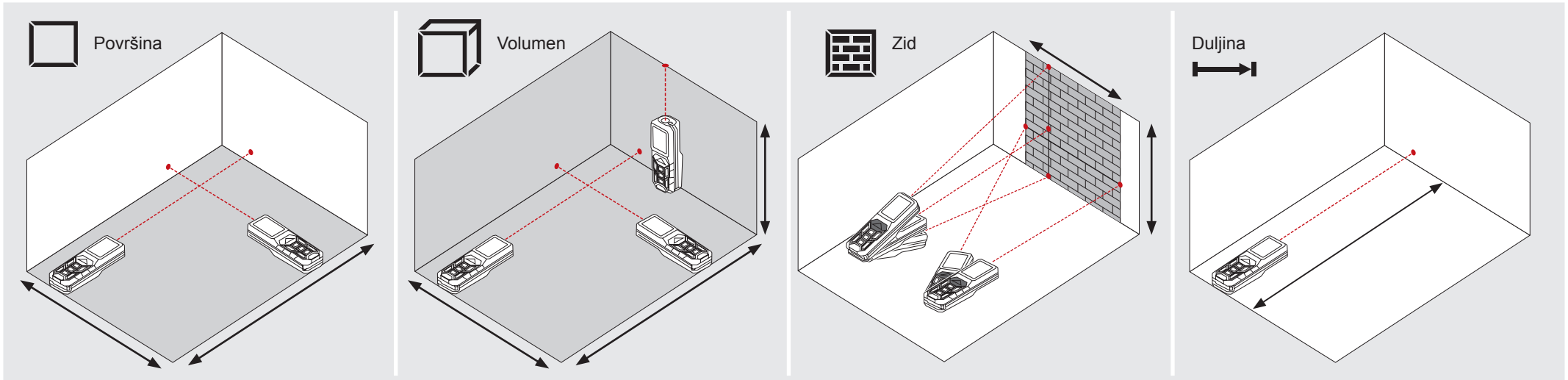

JEDNOSTAVNO MJERENJE DULJINE

0	1	2	3	4

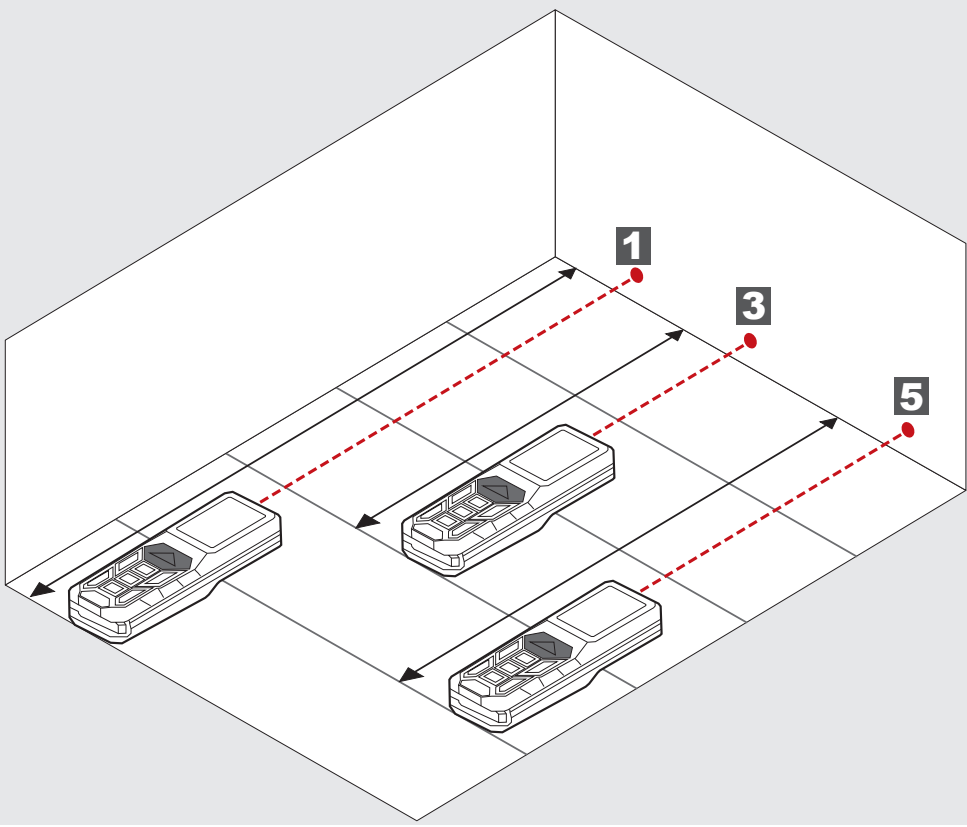

5

KONTINUIRANO MJERENJE / MJERENJE MINIMUM-MAXIMUM

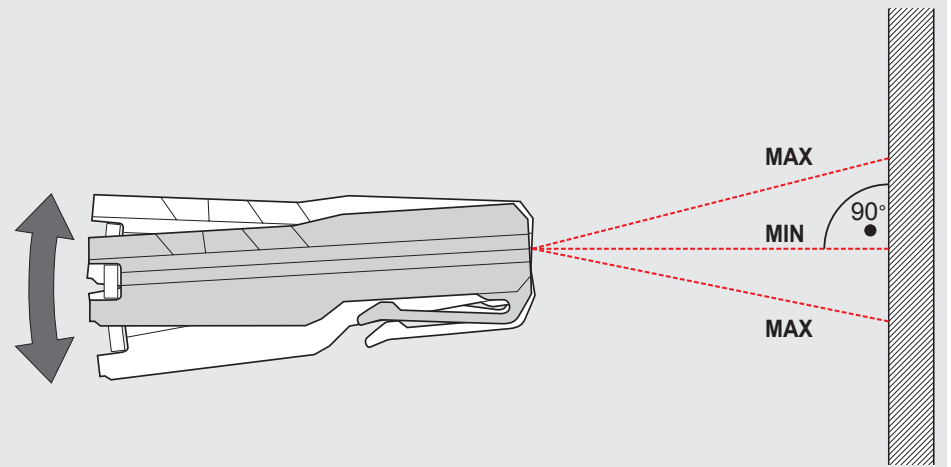
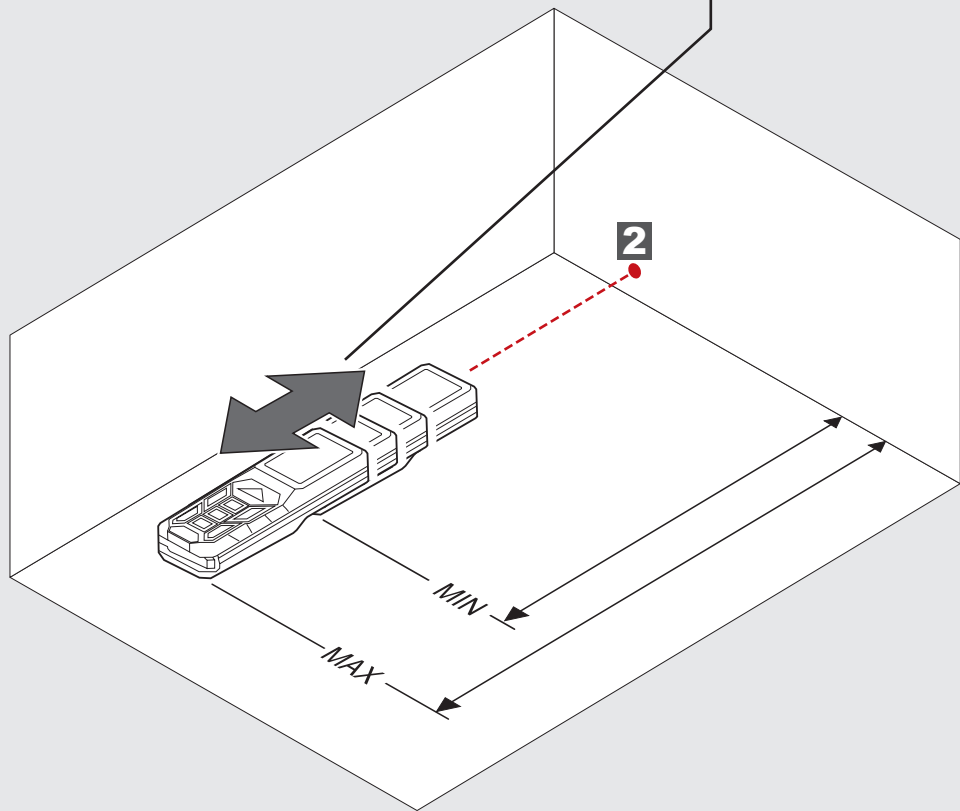
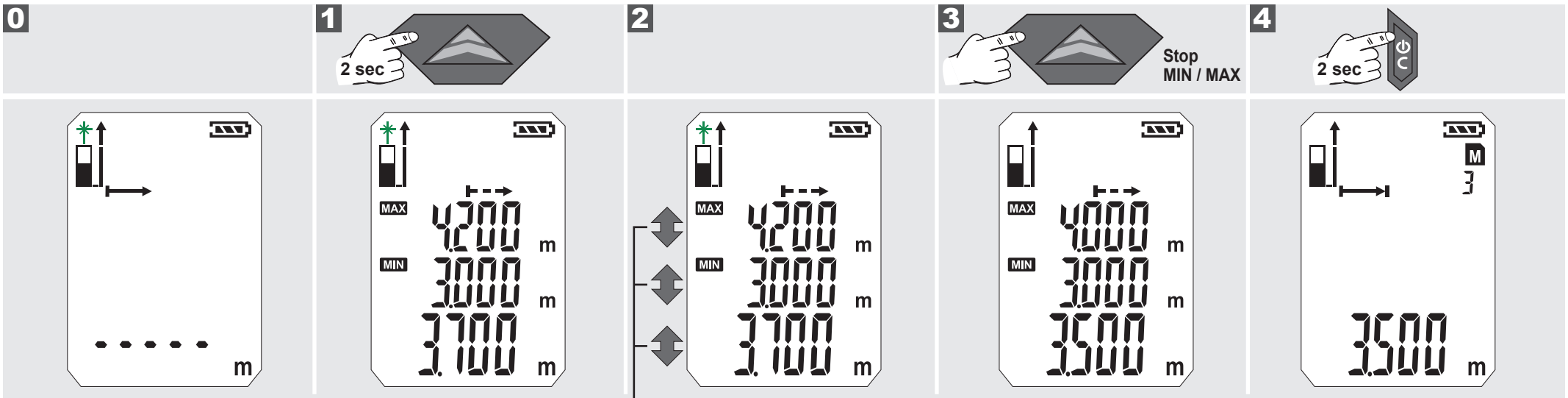

0

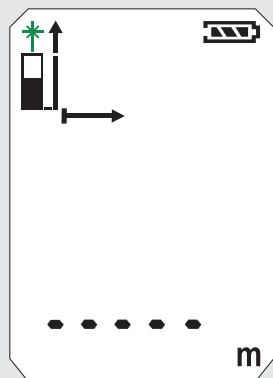

1

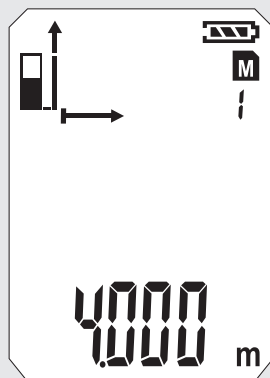
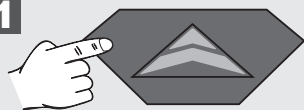

2

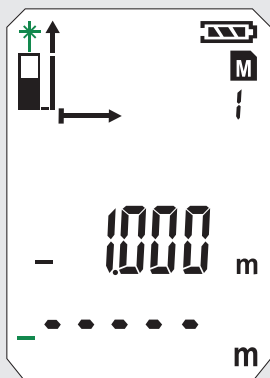
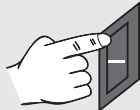

3

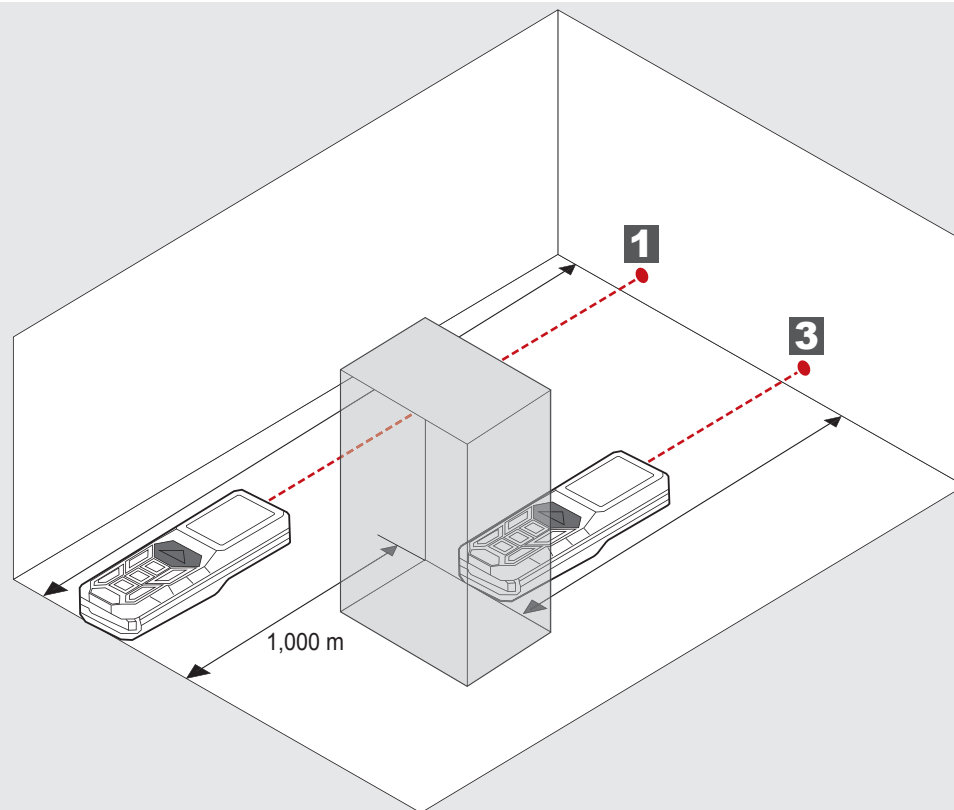
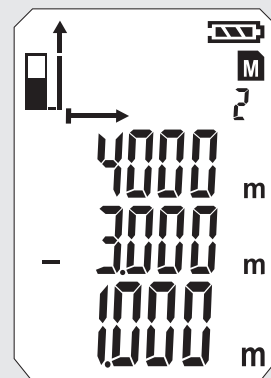
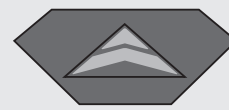

0



1

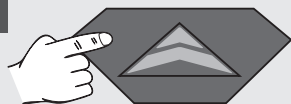

2

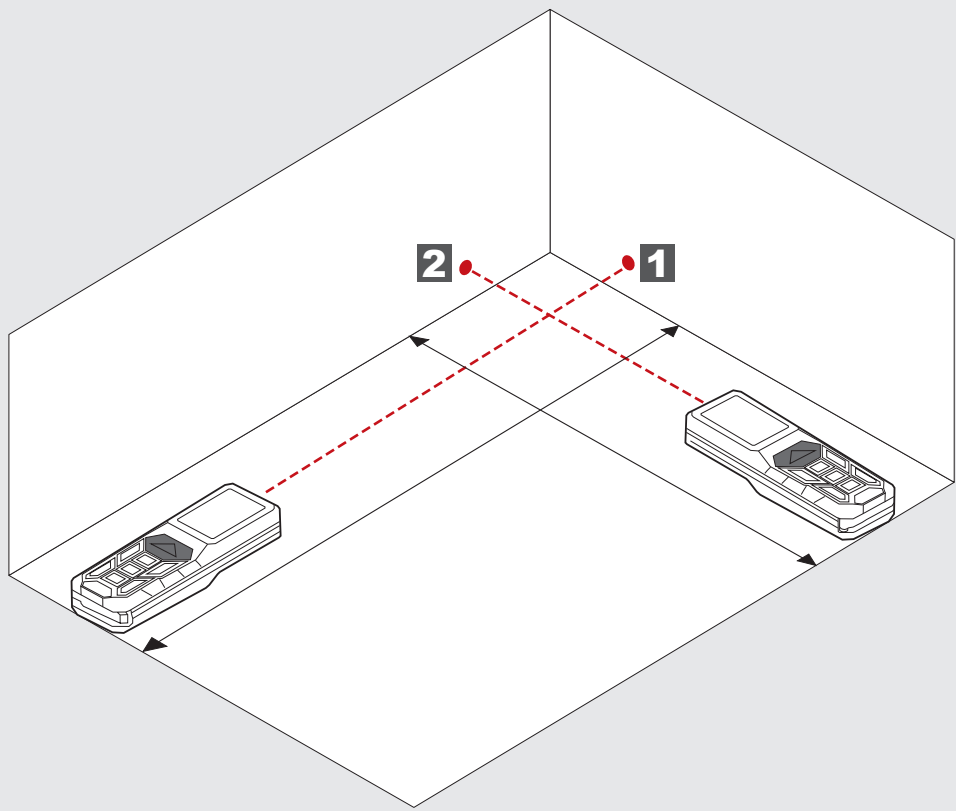
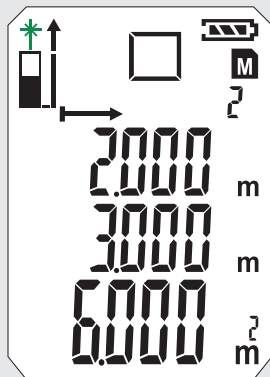
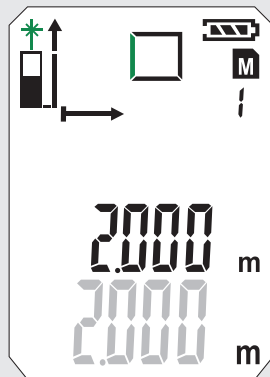
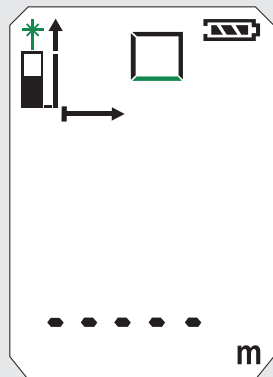
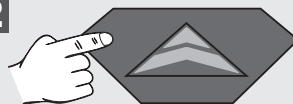

MJERENJE VOLUMENA

0

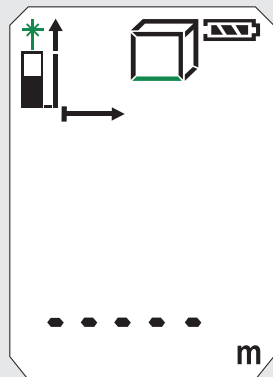

1

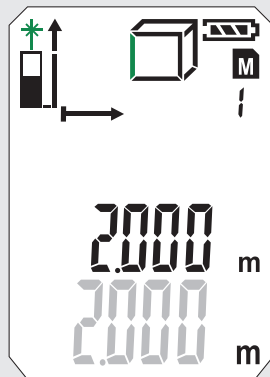
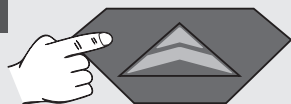

2

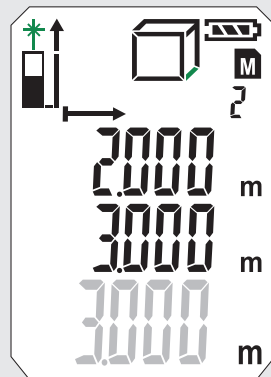
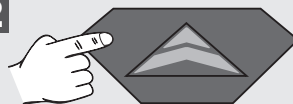

3

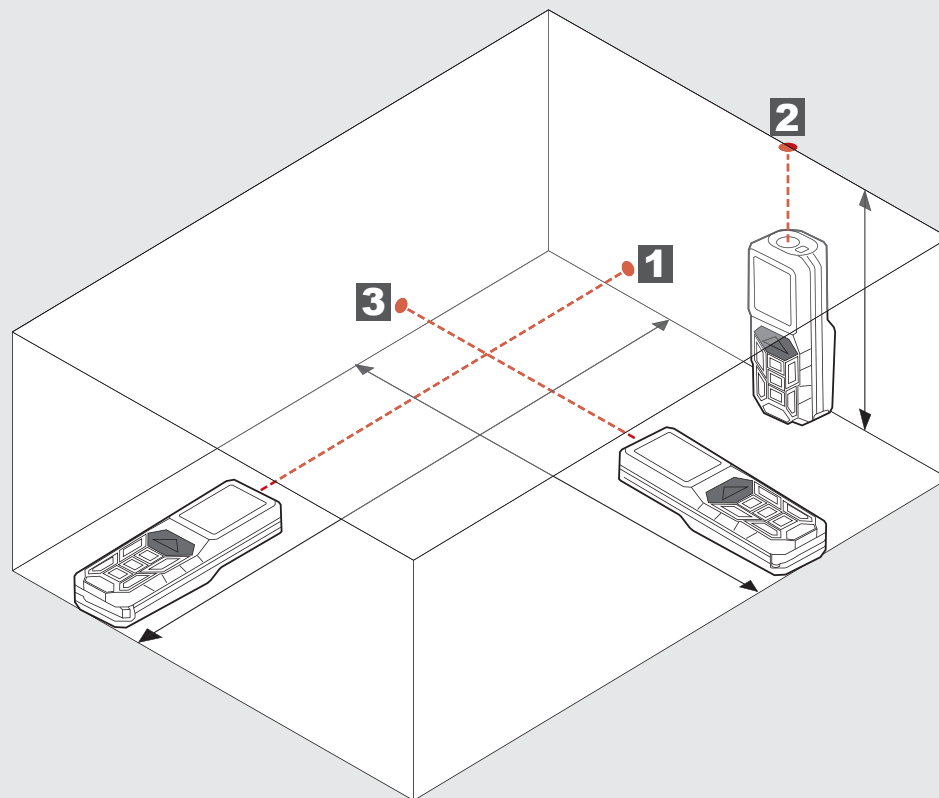
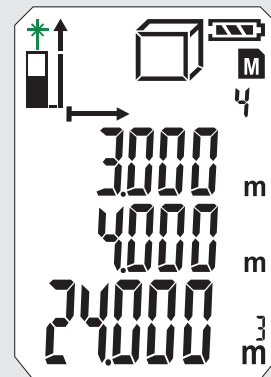
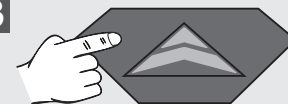

INDIREKNO MJERENJE (PITAGORA 1)

0



1

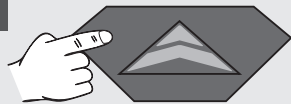

2

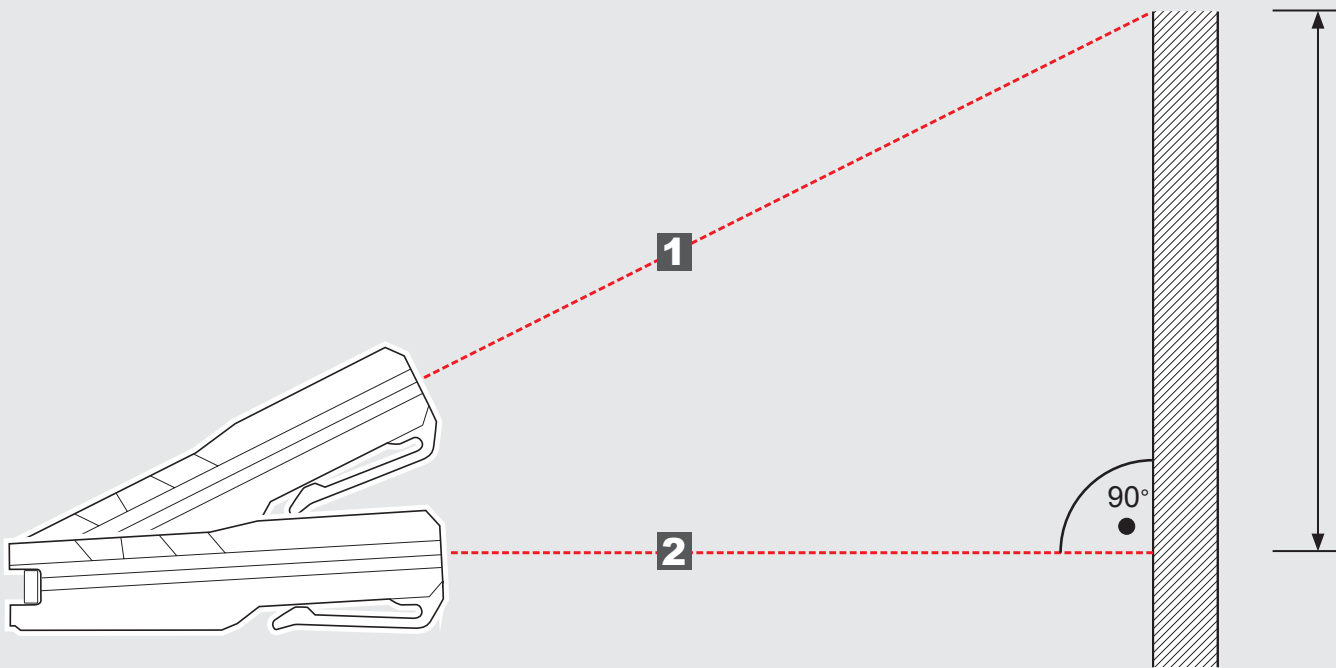
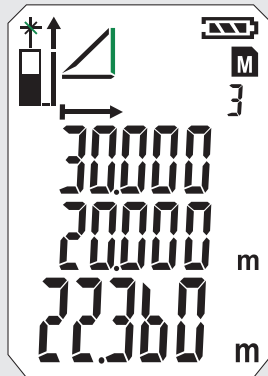
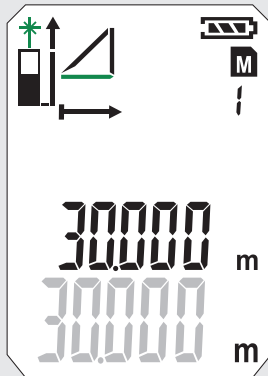
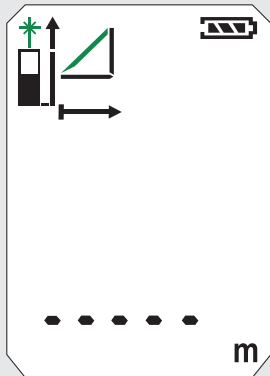
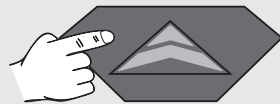

INDIREKTNO MJERENJE (PITAGORA 2)

0



1

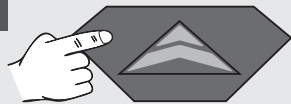

2

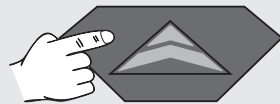

3

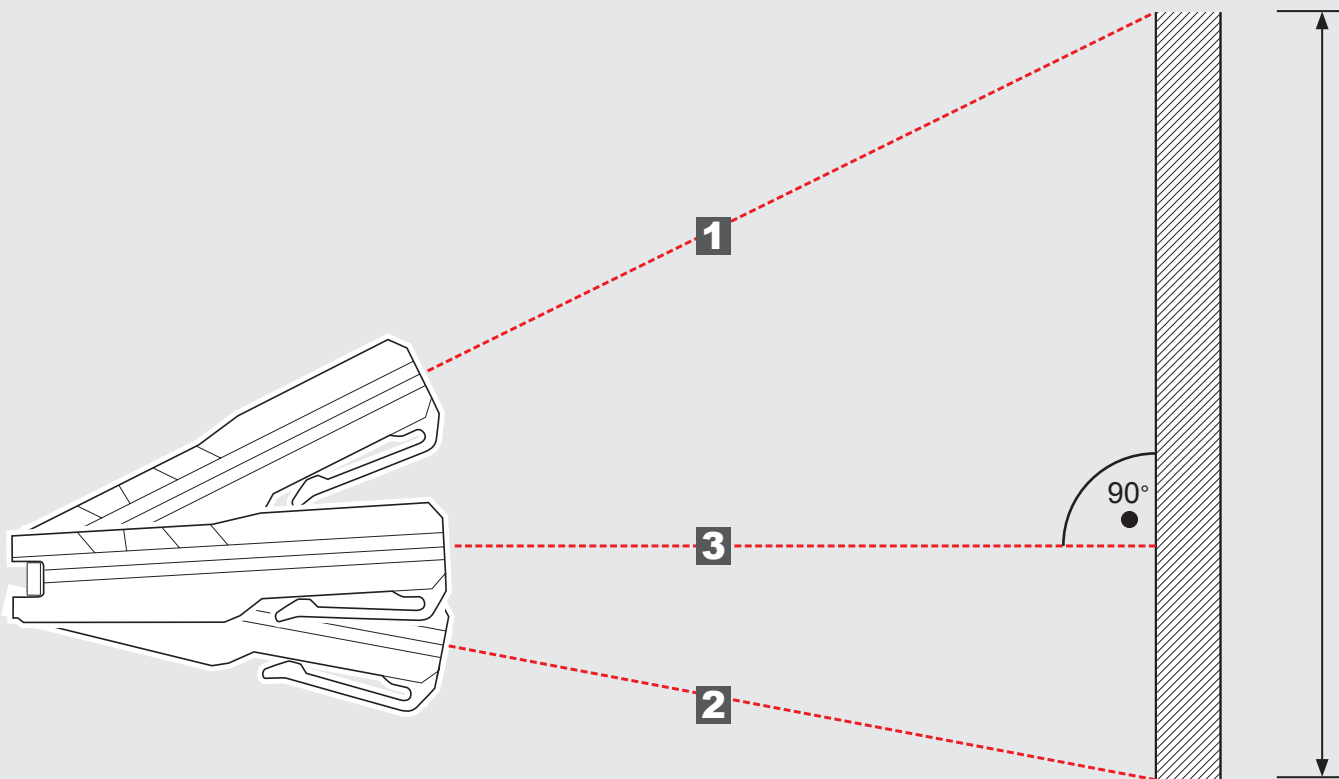
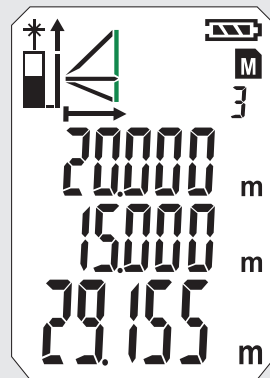
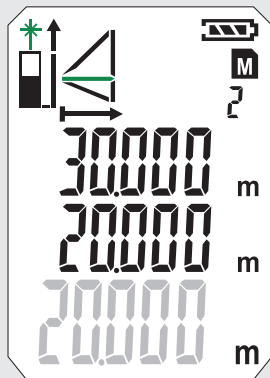
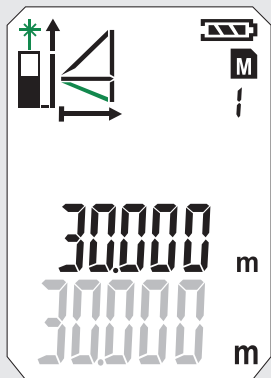
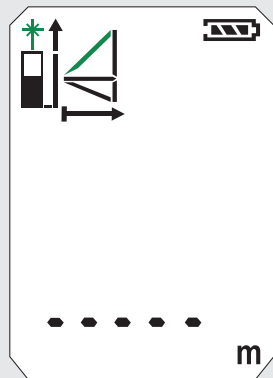
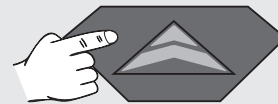

INDIREKTNO MJERENJE (PITAGORA 3)

1



2

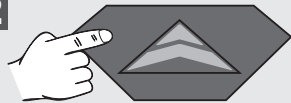



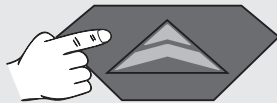



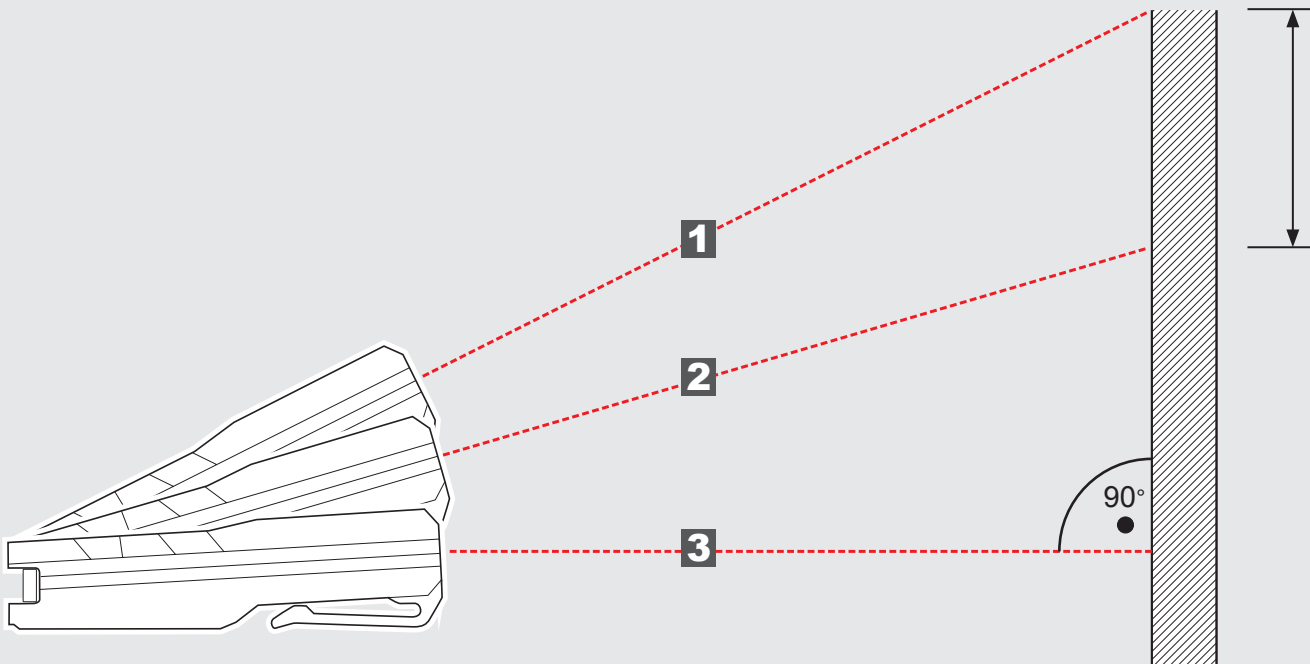
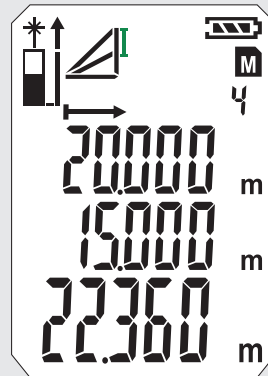
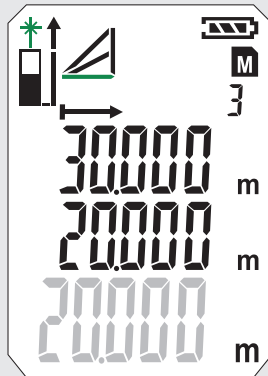
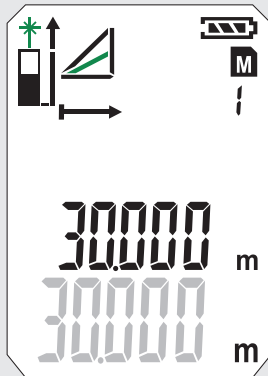
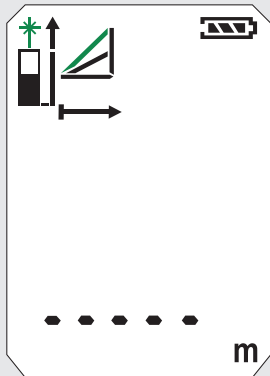
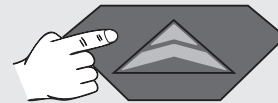

3



4

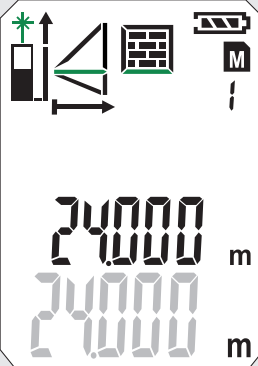

MJERENJE ZIDNE POVRŠINE (SCENARIO 1)

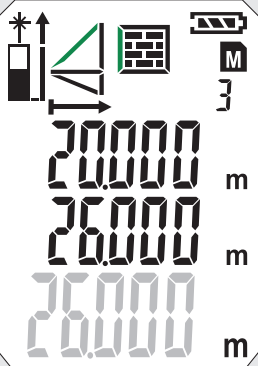
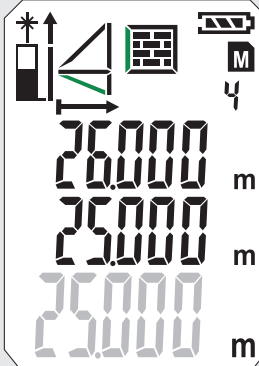
0 	1 	2 	3 	4 
				

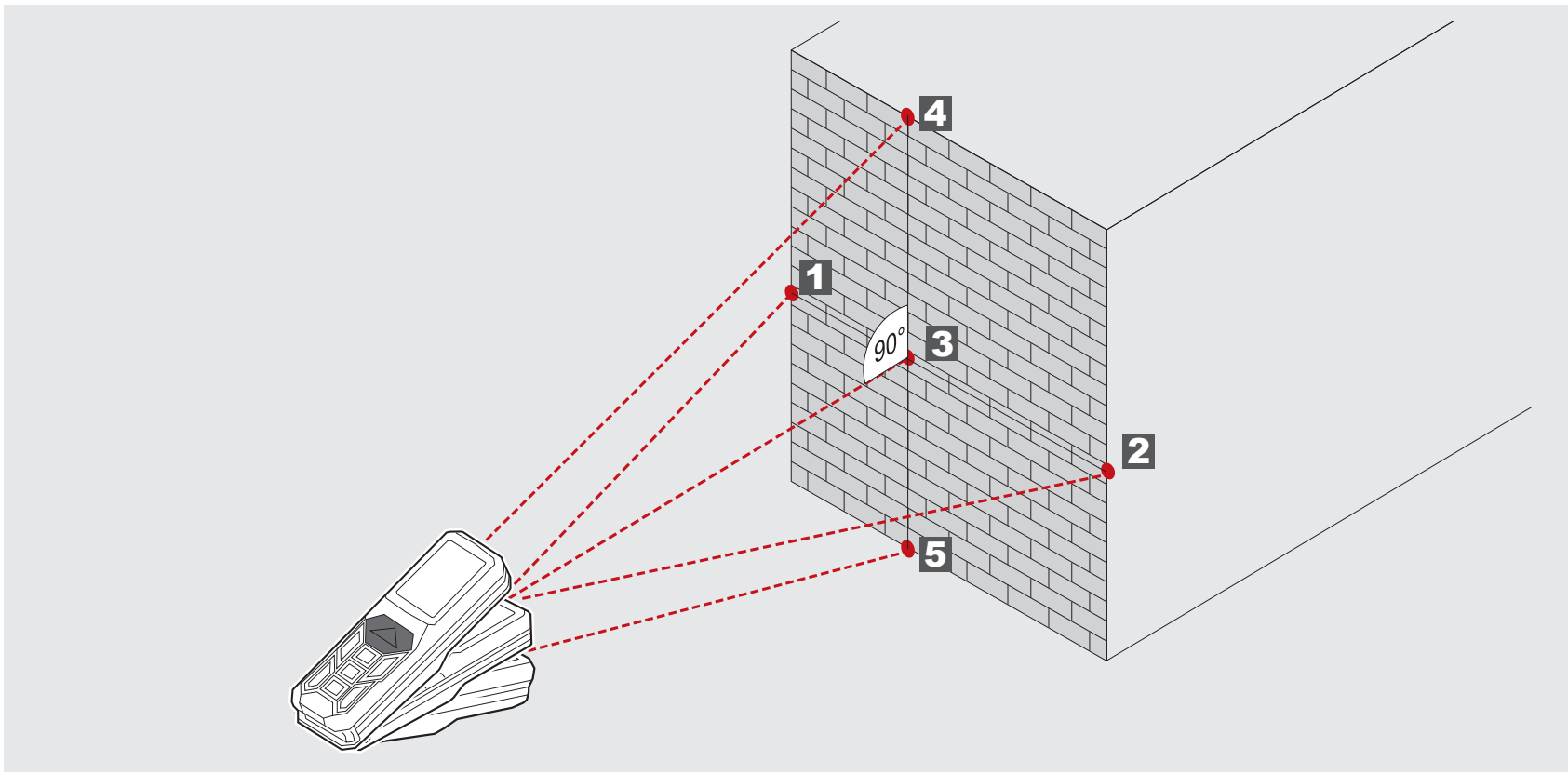



5

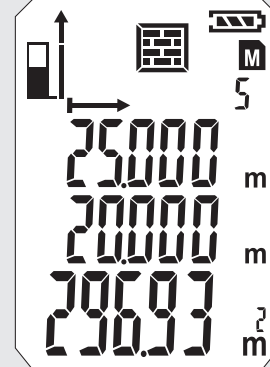

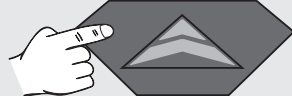
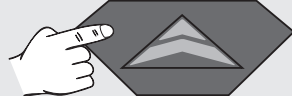
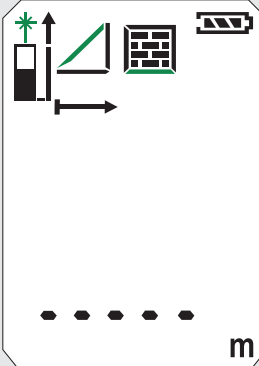
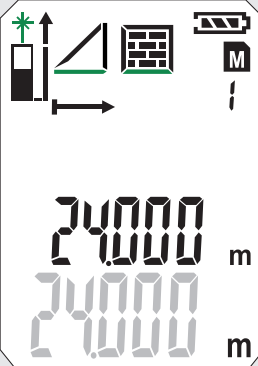
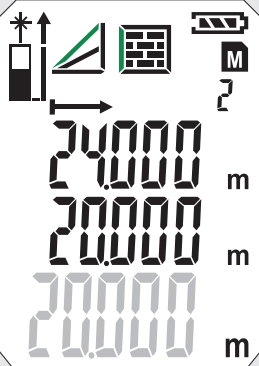
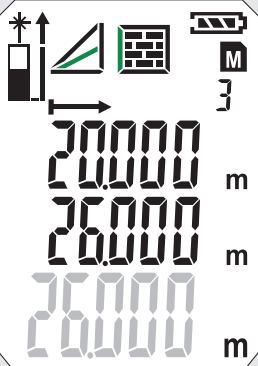
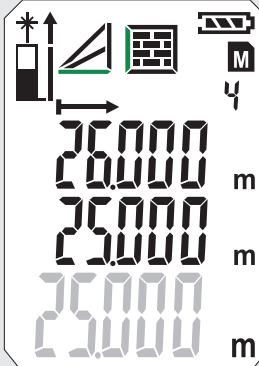

MJERENJE ZIDNE POVRŠINE (SCENARIO 2)

0 	1 	2 	3 	4 
				

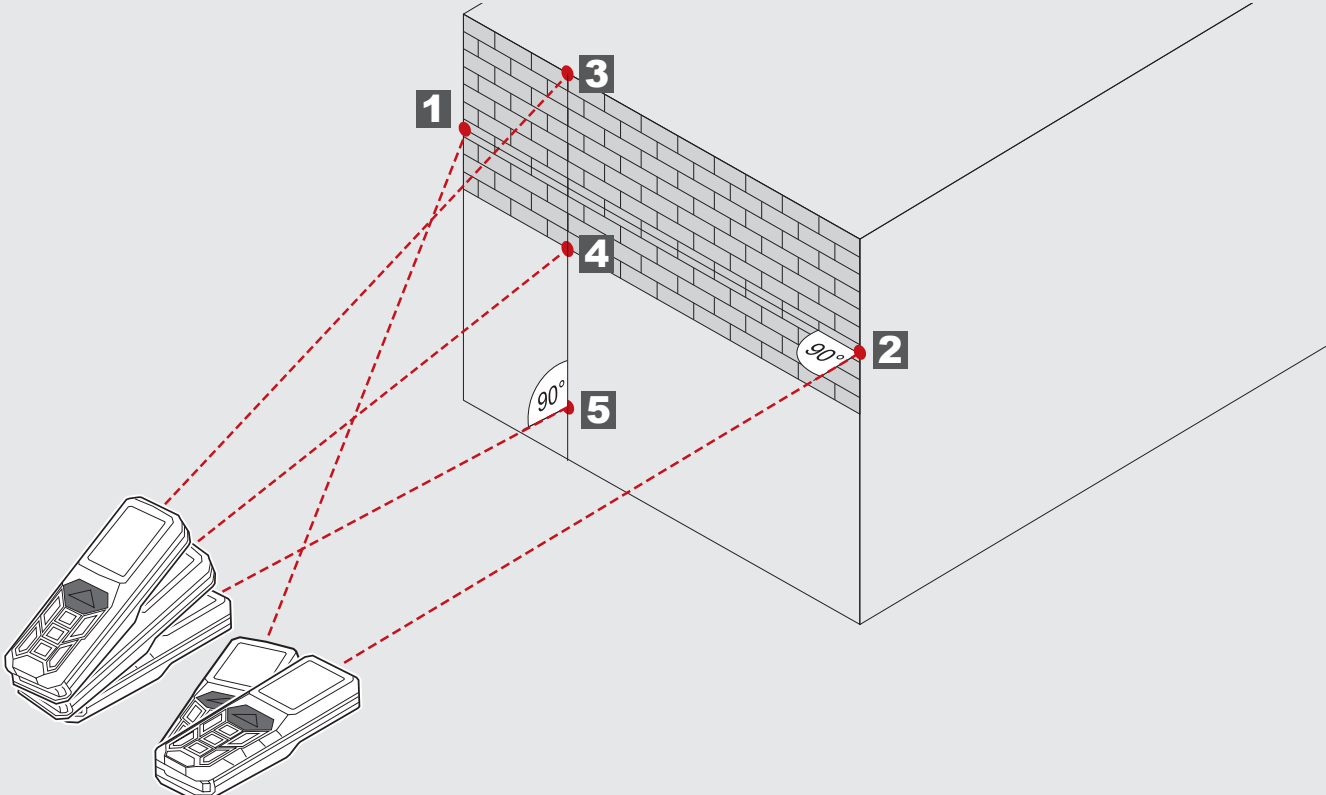

5



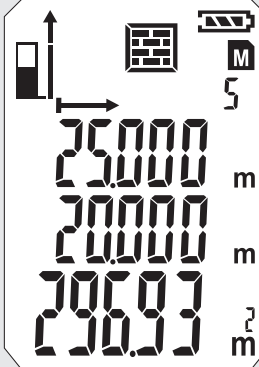

TIMER

Sa Timerom se mjerenje može usporeno aktivirati, da bi se npr. jedan element pozicionirao u mjernoj zruci.

Tipku  pritisnuti

- Pojavi se simbol  se Timer može podesiti između 3 i 15 sek.

Pritisnuti tipku 

- Sekunde će se do mjerenja brojiti naniže.
- Kod 0 se mjerenje aktivira.

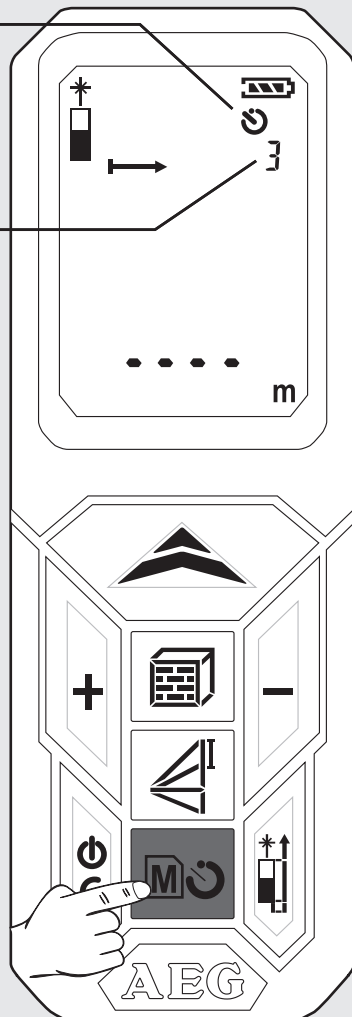

MEMORIJA

Mjerne vrijednosti će automatski neprekidno biti odložene u memoriju.

Memorirane vrijednosti se sa tipkom  mogu pozvati.

Tipku  2 sek. pritisnuti

- Pojave se simbol i mjesto memorije.
- Prikazuje se pripadajuća mjerna veličina.
- Memorirana vrijednost će biti prikazana u glavnom retku.
- Navigirati sa tipkama +/-

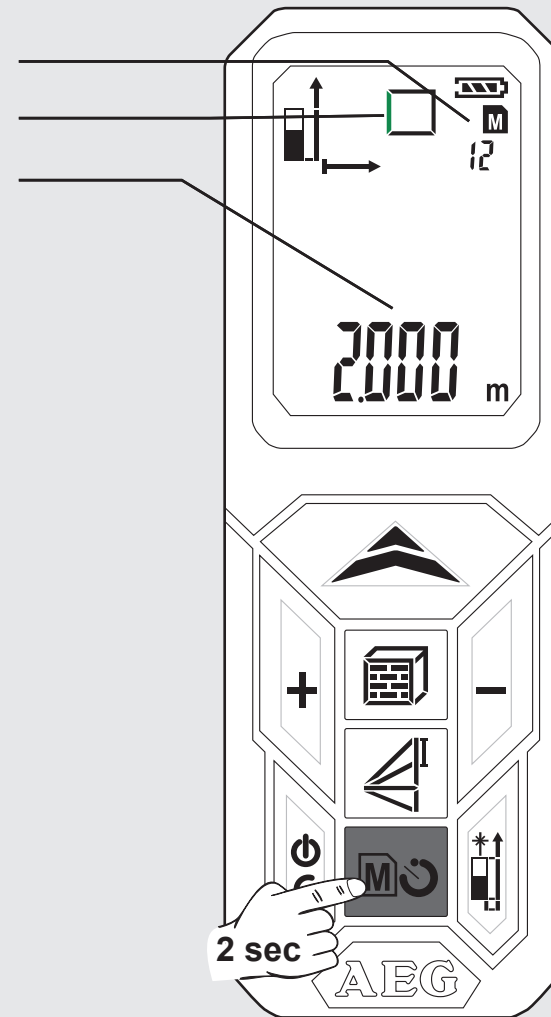



TEMELJITI NAČIN FUNKCIJE NA PRIMJERU JEDNOG MJERENJA POVRŠINE (1)

1 Uključiti

Pritisnuti tipku 
⚠ Pažnja! Laserska zraka uključena!
 Ne uperiti na osobe!

2 Odabrani mjernu ravninu

Standardno namještanje nakon uključivanja:
 straga
 1x pritisnuti -> kutni zatik
 2x pritisnuti -> sprijeda
 3x pritisnuti -> straga

3 Odabrali funkciju

Nakon uključivanja aparat stoji uvijek na mjerenju duljine.
 1x pritisnuti - mjerenje površine

4 Mjeriti duljinu

Aparat usmjeriti i pritisnuti tipku 

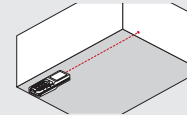

5 Mjerenje širine

Aparat usmjeriti i tipku  pritisnuti

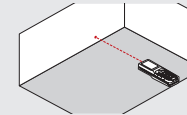

Laserski simbol treperi (blinken grün dargestellt).

Prikazuje se simbol

- Pojavljuje se simbol
 - Mjerna veličina treperi (blinken grün dargestellt)

- Mjerna vrijednost se nakratko prikazuje u glavnom retku.
 - Mjerna vrijednost poslije 1 sek. skače u iznad toga ležeći redak.
 Mjerna vrijednost će u memoriji biti odložena pod rednim broje.
 Druga mjerna veličina treperi. Aparat je spreman za mjerenje druge vrijednosti.

- Mjerna vrijednost se nakratko pojavi u glavnom retku.
 - Mjerna vrijednost poslije 1 sek. skače u iznad toga ležeći redak.
 Mjerna vrijednost će u memoriji biti odložena pod rednim broje.
 - Rezultat će biti prikazan u glavnom retku i odložen u memoriju pod rednim brojem.

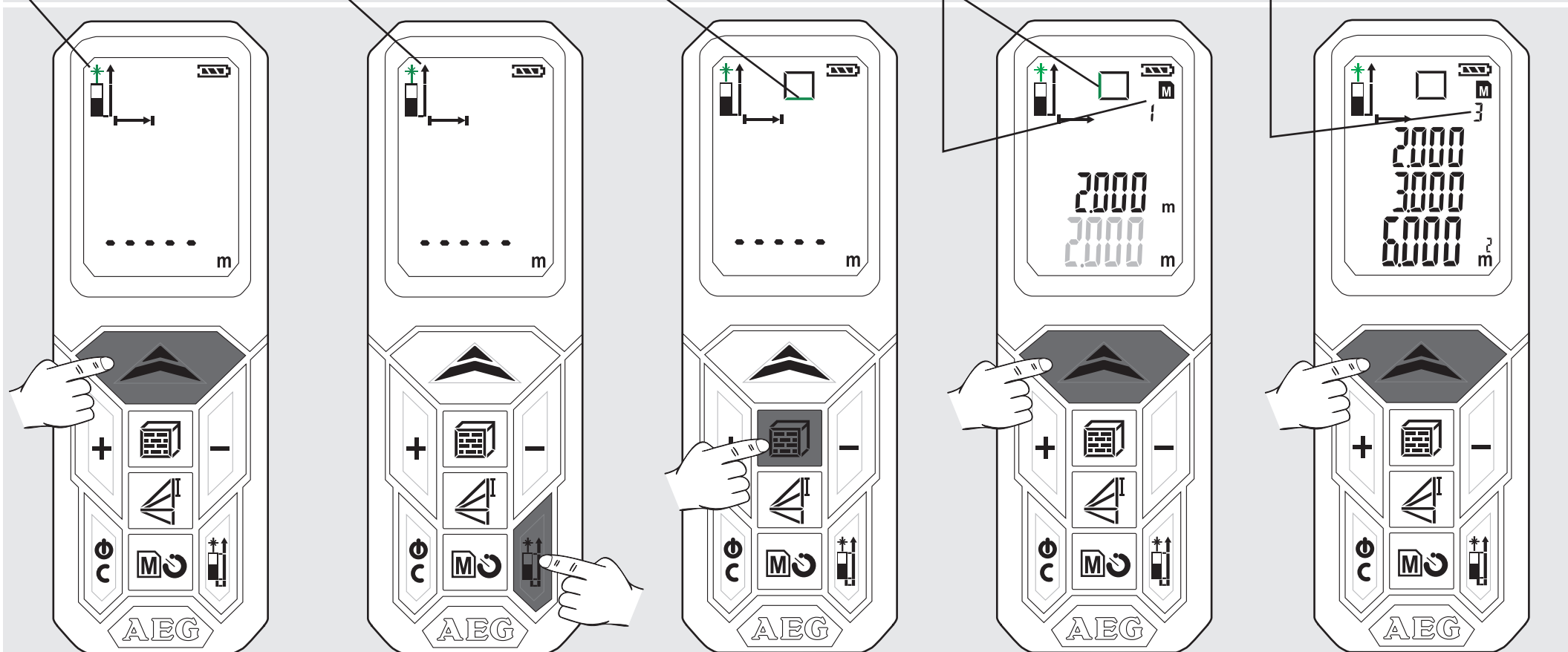

TEMELJITI NAČIN FUNKCIJE NA PRIMJERU JEDNOG MJERENJA POVRŠINE (2)

6 Pozvati memorirane vrijednosti

Tipku  pritiskati 2 sek.
Pritisnuti tipku + ili -

7 Napustiti memoriju

Pritisnuti tipku 

8 Isključiti

Tipku  pritiskati 2 sek.
(Speicher muss vorher verlassen werden).

- Memorirane vrijednosti će biti prikazane u glavnom retku.

- Pripadajući simbol će biti prikazan i mjerna veličina treperi (blinken grün dargestellt).

- Aparat se isključuje.

- Ako se 3 minute dugo ne pritišće nikakva tipka, aparat se automatski isključuje.

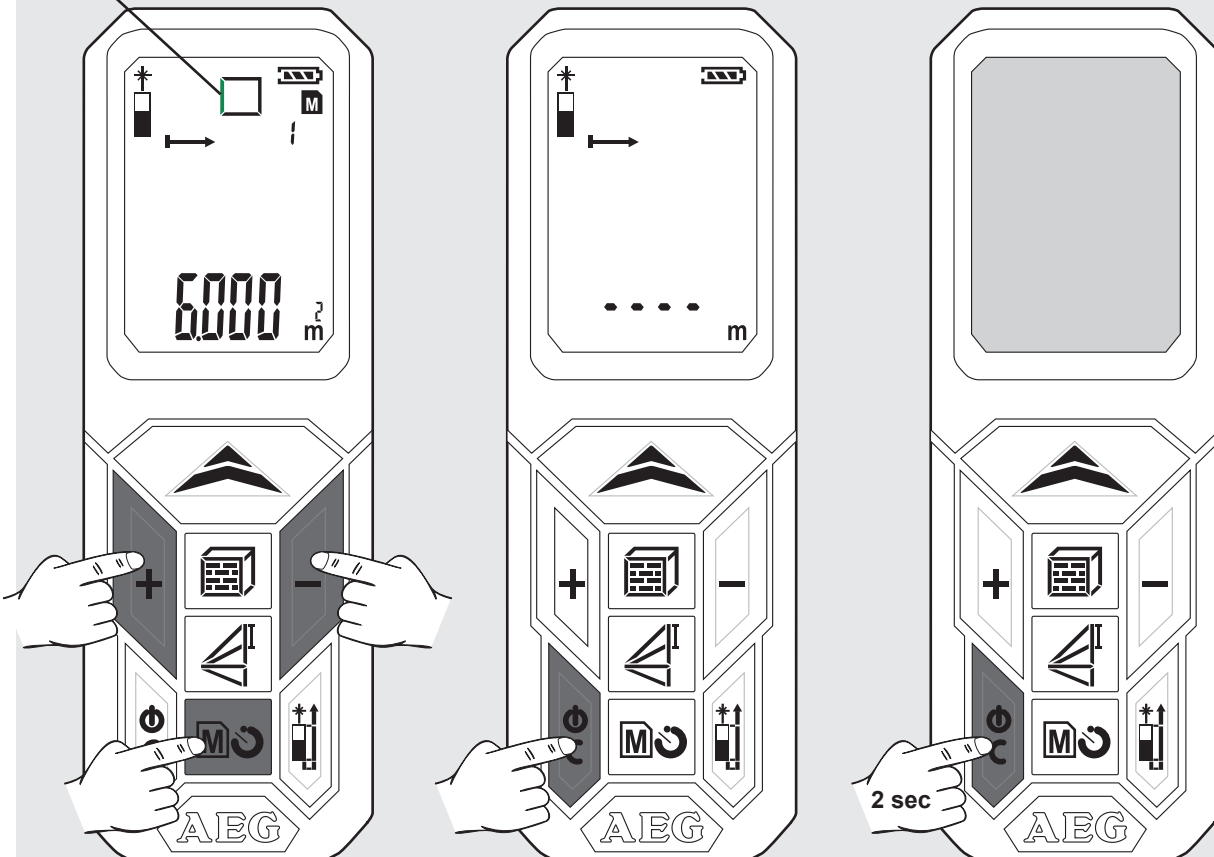

SATURS

SVARĪGI DROŠĪBAS NOTEIKUMI.....	1
Tehniskie dati.....	2
Noteikumiem atbilstošs izmantojums	2
Kļūdu kodu tabula.....	2
Pārskats.....	3
Bateriju nomaiņa.....	4
Stūra kāja	4
Jostas turētājs	4
Funkcijas taustiņi, Pitagors, mērījuma līmenis	5
Vienkāršā garuma mērīšana	6
Nepārtrauktā mērīšana/ Minimāla-maksimāla mērīšana....	7
Mērīšana pieskaitot/ atņemot	8
Laukuma mērīšana.....	9
Tilpuma mērīšana	10
Netiešā mērīšana (Pitagors 1).....	11
Netiešā mērīšana (Pitagors 2).....	12
Netiešā mērīšana (Pitagors 3).....	13
Sienas laukuma mērīšana (1. variants).....	14
Sienas laukuma mērīšana (2. variants).....	15
Taimeris	16
Atmiņa	16
Pamata darbības uz virsmas mērījuma pamata (1).....	17
Pamata darbības uz virsmas mērījuma pamata (2).....	18

SVARĪGI DROŠĪBAS NOTEIKUMI



Pirms šī produkta lietošanas uzmanīgi izlasiet drošības instrukcijas un lietošanas rokasgrāmatu.

Lāzera klasifikācija

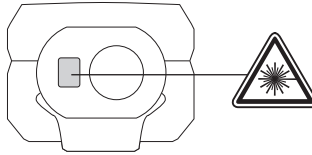

BRĪDINĀJUMS:

Tas ir **2. klases** lāzera produkts saskaņā ar IEC 60825-1:2007.



Marķējums

Pirms pirmās pieņemšanas ekspluatācijā angļu valodas teksts firmas dēlītī ir jāaizlīmē ar piegādāto uzlīmi Jūsu dzimtā valodā.

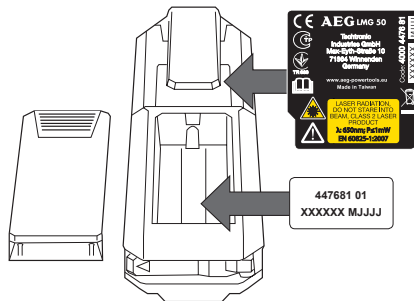

Brīdinājums:

Izvairieties no tieša acu kontakta. Lāzera stars var Jūs apžilbināt un izraisīt īslaicīgu aklumu.

Neskatieties uz lāzera staru un nevērsiet to bez vajadzības uz citiem cilvēkiem.

Neapžilbiniet citus cilvēkus.

Brīdinājums: Nedarbiniet lāzera ierīci bērnu tuvumā, kā arī neļaujiet bērniem pašiem to izmantot.

Uzmanību! Atstarojoša virsma var atstarot lāzera ierīces staru uz citām ierīcēm vai cilvēkiem.

Turiet ekstremitātes drošā attālumā no kustīgajā daļām.

Periodiski veiciet pārbaudes mērījumus. It sevišķi, mērījumu laikā vai pirms svarīgiem mērījumiem.

Ja instruments sabojājies, bija nokritis, nepareizi pielietots vai tika pārveidots, pārbaudiet, vai attāluma mērījumi nav kļūdaini.

Uzmanību! Lepazīstieties ar dārza instrumenta vadības elementiem un tā pareizu lietošanu.

Lāzera mērierīcei ir ierobežots pielietojums. (Skatīt sadaļu "Tehniskā informācija"). Veicot mērījumus ārpus minimālā un maksimālā mērīšanas apgabala, iegūtie rezultāti būs neprecīzi. Izmantojot ierīci nelabvēlīgos apstākļos, piemēram, karstumā, lielā aukstumā, ļoti spožā saules gaismā, lietū, sniegā, miglā vai citos redzamību ierobežojošos apstākļos, iegūtie rezultāti var būt neprecīzi.

Ienesot lāzera mērierīci no siltas apkārtējās vides aukstā vidē (un otrādi), pagaidiet, līdz ierīce ir pielāgojusies attiecīgās vides apkārtējai temperatūrai.

Vienmēr uzglabājiet lāzera mērierīci telpās, kas sniedz aizsardzību pret satricinājumiem, vibrācijām vai ekstrēmām temperatūrām.

Nepakļaut lāzera mērierīci putekļu, mitruma un augsta relatīvā gaisa mitruma ietekmei. Šie faktori var nodarīt bojājumus ierīces iekšienē, līdz ar to var tikt ietekmēta mērījumu precizitāte.

Tīrīšanai neizmantojiet agresīvus tīrīšanas līdzekļus vai šķīdinātājus. Tīrīt tikai ar tīru, mīkstu lupatiņu.

Rūpējieties, lai mērierīce nesaņemtu stiprus triecienus vai nenokristu no bīstama augstuma. Ja ierīce tomēr ir nokritusi vai ir tikusi pakļauta cita veida mehāniskajai slodzei, pārbaudiet tās precizitāti.

Nepieciešamos lāzera ierīces remontdarbus var veikt tikai apmācīti darbinieki.

Nelietojiet to sprādzienbīstamās vietās vai agresīvā vidē.

Lai uzlādētu baterijas, izmantojiet tikai ražotāja apstiprinātus lādētājus.



Tukšās baterijas nedrīkst izmest sadzīves atkritumu tvertnē. Rūpējieties par vidi un aizvediet tās uz speciālajiem savākšanas punktiem, kas ir izveidoti saskaņā ar nacionālo vai vietējo likumdošanu.

Ierīci nedrīkst izmest sadzīves atkritumu tvertnē. Izvietojiet produktu atbilstoši spēkā esošajiem nacionālajiem noteikumiem. Stingri ievērojiet valsts un vietējos specifiskos noteikumus. Par ierīces nodošanu pārstrādei, sazinieties ar tuvāko veikalu vai savu izplatītāju.

CE CE marķējums

TEHNISKIE DATI

Aizsardzības klase	IP54 (aizsargāta pret putekļiem un šļakatām)
Optika	14 mm
Fokuss	35 mm
Maksimālais mērījumu apgabals	50 metri (tolerance: 55m)
Minimālais mērījumu apgabals	0,05 metri
Absolūtā precizitāte @ < 10m	± 1,5 mm (maksimāli)
Atkārtota precizitāte @ < 10m	± 1,5 mm (parasti maksimāli 2σ)
Atkārtota precizitāte @ > 10m	kāpums ± 0,25 mm / metrā (parasti maksimāli 2σ)
Mērīšanas laiks	0,5 s
Displeja veids	LCD (22,7 mm x 31 mm)
Strāvas avots	AAA 2x (sārnu baterijas)
Bateriju resurss	10000 (atsevišķi mērījumi)
Lāzera izejošā jauda	0,6 mW ~ 0,95 mW (2. klase, 650nm)
Lāzera punkta lielumse	25 x 30 mm @ 16 m (maksimāli)
Lāzera stara vertikālais leņķis	+1 grāds
Lāzera stara horizontālais leņķis	±1 grāds
Ierīces automātiskā izslēgšana	180 sekundes
Automātiskā lāzera izslēgšana	30 sekundes
Darba temperatūra	-10°C to +50°C
Uzglabāšanas temperatūra	no -25°C līdz +70°C
Svars bez baterijām	80 g

NOTEIKUMIEM ATBILSTOŠS IZMANTOJUMS

Lāzera mērierīce ir piemērota attālumu un slīpuma mērīšanai

Šo instrumentu drīkst izmantot tikai saskaņā ar minētajiem lietošanas noteikumiem.

KĻŪDU KODU TABULA

Kods	Apraksts	Risinājums
Err01	Ārpus mērījuma apgabala	Veiciet mērījumu pieļaujamā apgabala robežās.
Err02	Atstarotais signāls ir pārāk vājš	Izvēlieties labāku virsmu.
Err03	Ārpus rādījumu apgabala (maksimālā vērtība: 99.999), piemēram, laukuma vai tilpuma iznākums ir ārpus parādāmās vērtības	Pārbaudiet, vai vērtības un darbības ir pareizas.
Err04	Kļūda Pitagora aprēķinā	Pārbaudiet, vai vērtības un darbības ir pareizas.
Err05	Zems bateriju līmenis	Ievietojiet jaunas baterijas.
Err06	Ārpus pieļaujamās darba temperatūras	Veiciet mērījumus norādītās darba temperatūras diapazonā.
Err07	Pārāk gaišs	Aptumšojiet mērķa apgabalu.

Pitagora
Augstuma atšķirība

Mērījuma līmenis

Garuma mērījums

Nepārtraukta mērījuma minimums / maksimums

Pieskaitīšana / atņemšana

IESLĒGŠANA/ MĒRĪŠANA

- ▶ Ieslēgt
- ▶ Mērīt
- ▶ Nepārtrauktā mērīšana (turēt 2 sekundes)
Minimuma/ maksimuma funkcija

PIESKAITĪŠANA

- ▶ Vērtības pieskaitīšana
- ▶ Pārvietošanās atmiņā

LAUKUMS / TILPUMS

- ▶ Laukums (nospiest 1x)
- ▶ Tilpums (nospiest 2x)
- ▶ Netiešais virsmas mērījums (nospiest 3x / 4x)

IESLĒGŠANA

- ▶ Ieslēgt
- ▶ Izslēgt (turēt 2 sekundes)
- ▶ Dzēst

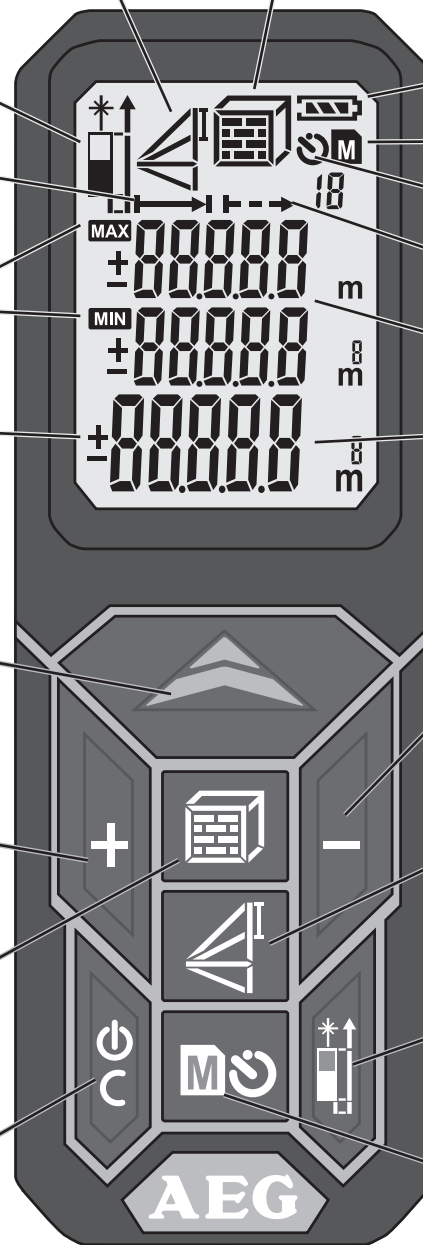

Laukums / tilpums
Netiešais laukuma mērījums

Bateriju uzlādes līmenis

Atmiņa

Taimeris

Nepārtraukta mērīšana

Starpvērtība

Kopējā vērtība

ATŅEMŠANA

- ▶ Atņemt vērtību
- ▶ Pārvietošanās atmiņā

PITAGORS

- ▶ Pitagors 1 (nospiest 1x)
- ▶ Pitagors 2 (nospiest 2x)
- ▶ Pitagors 3 (nospiest 3x)

MAINĪT MĒRĪJUMA LĪMENI

- ▶ Priekša
- ▶ Aizmugure
- ▶ Stūra kāja

ATMIŅA

- ▶ Taimeris 3-15 sekundes (nospiest 1x)
- ▶ Atmiņa 1-20 (nospiest 1x un turēt 2 sekundes)
- ▶ Pārvietoties pa atmiņu ar +/- taustiņiem

BATERIJU NOMAINA

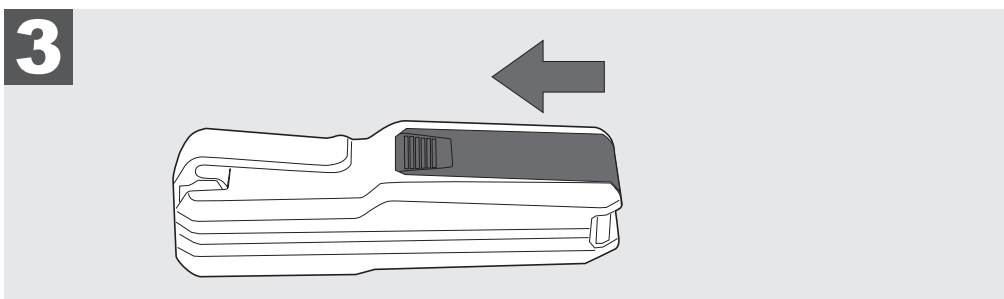
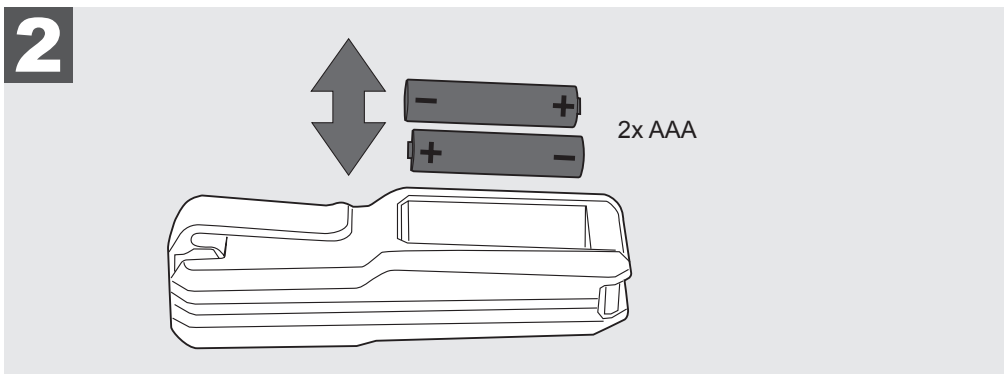
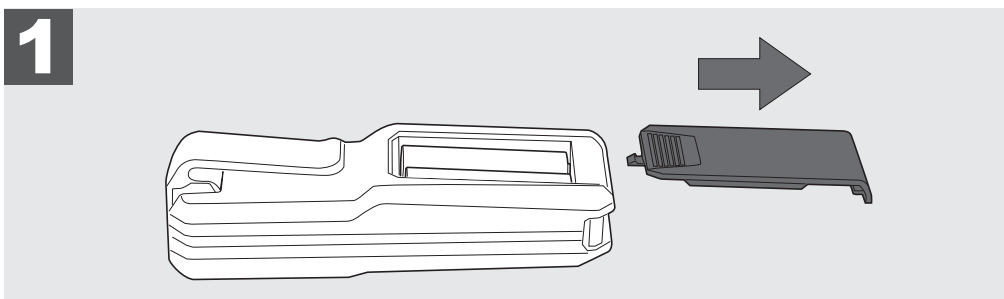
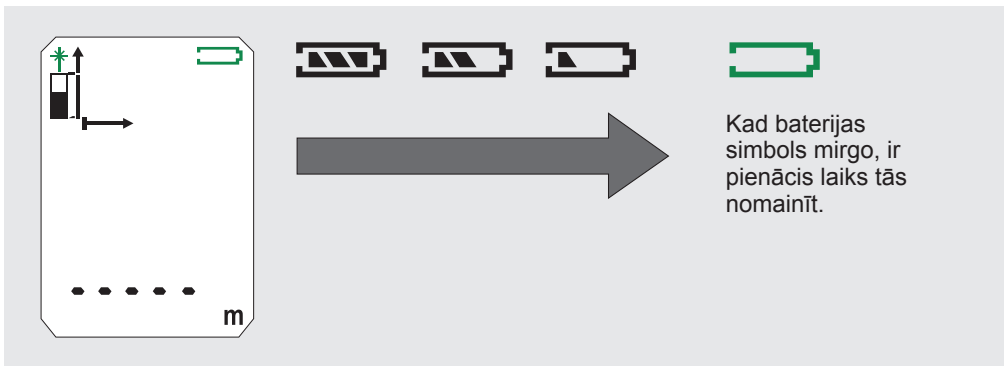

STŪRA KĀJA

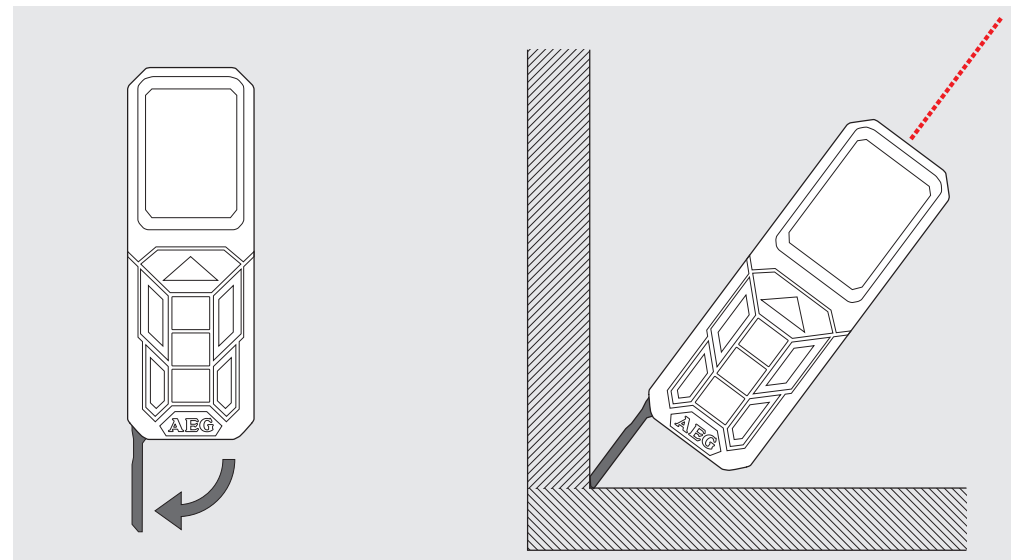

JOSTAS TURĒTĀJS

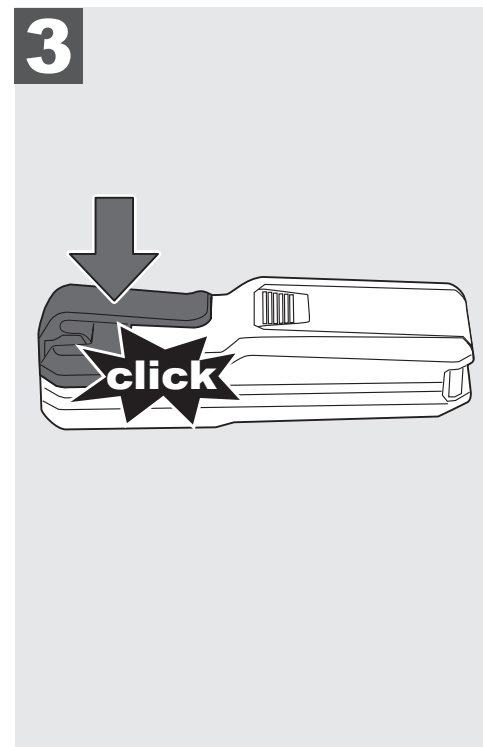
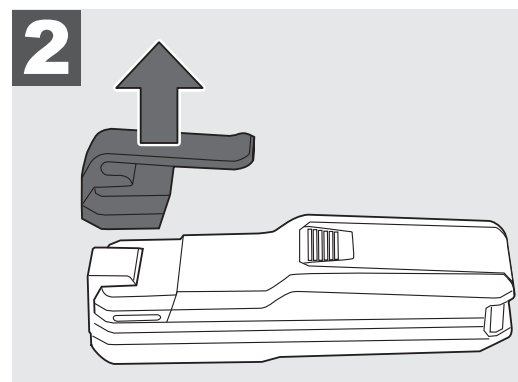
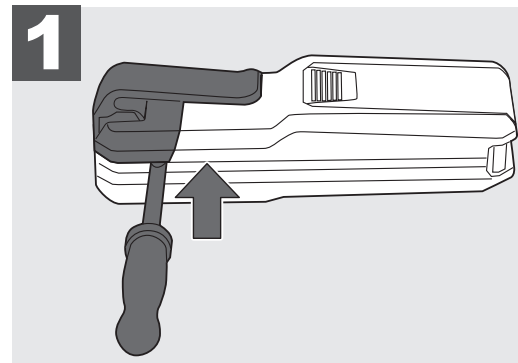

FUNKCIJAS TAUSTĪNI, PITAGORS, MĒRĪJUMA LĪMENIS

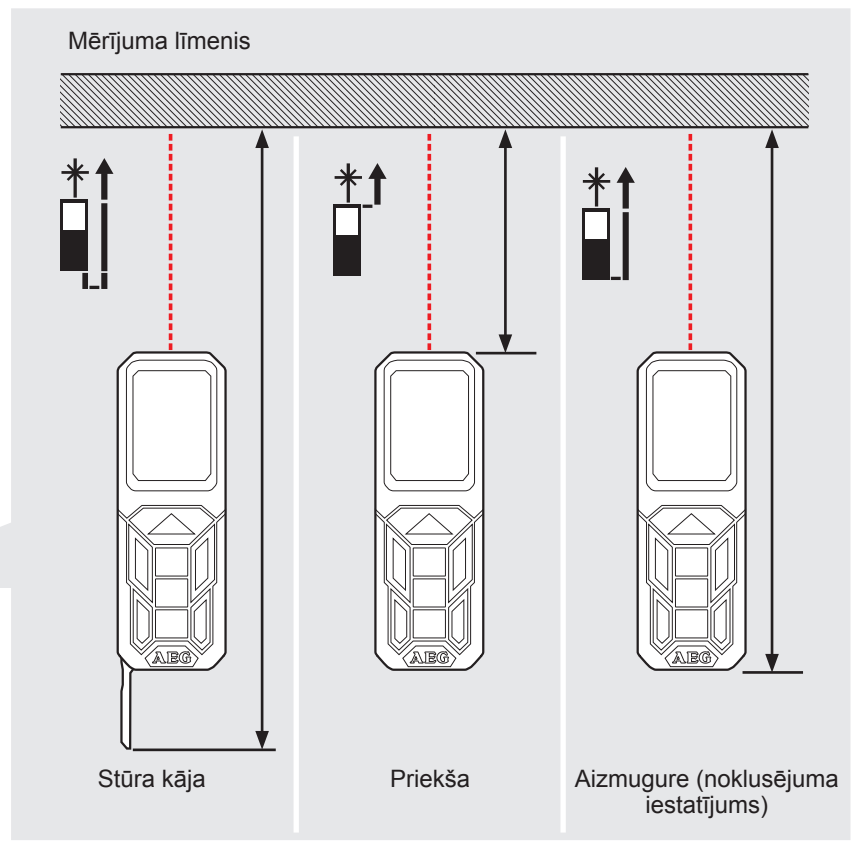
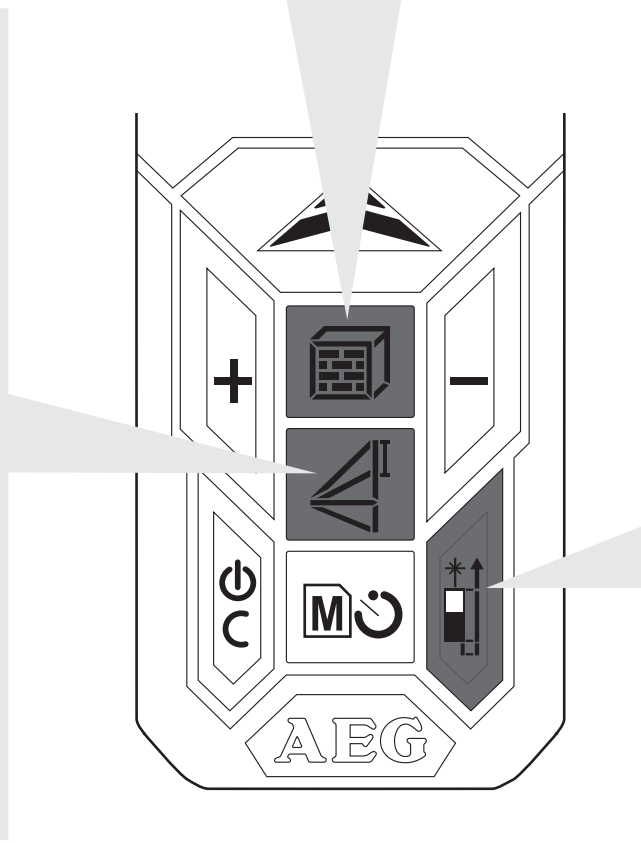
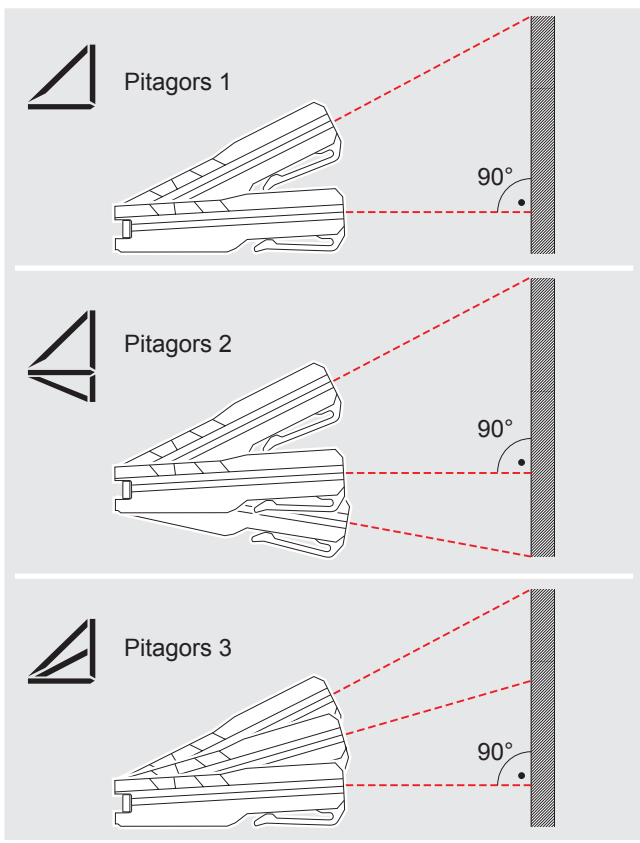
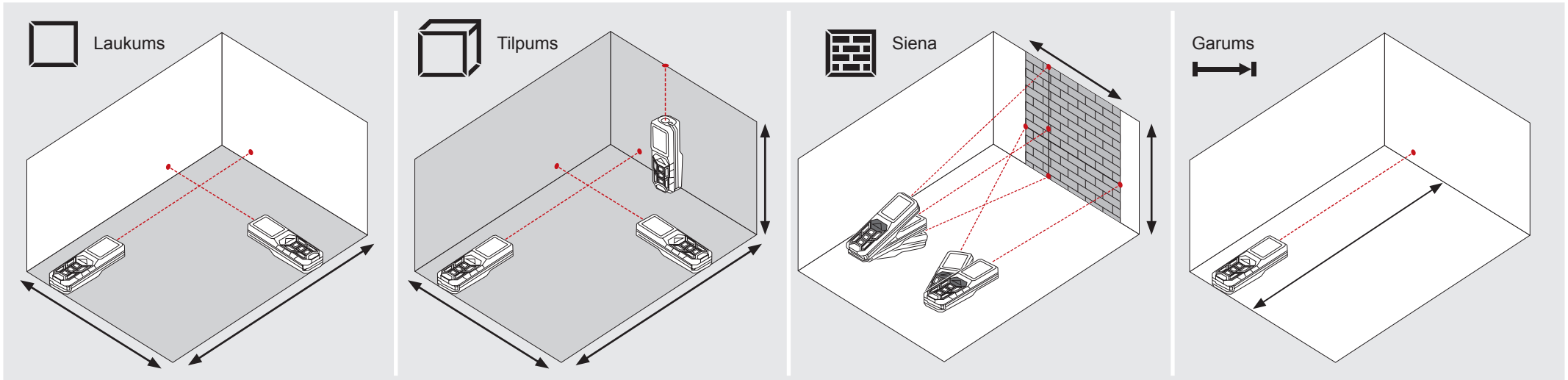

VIENKĀRSĀ GARUMA MĒRĪŠANA

0

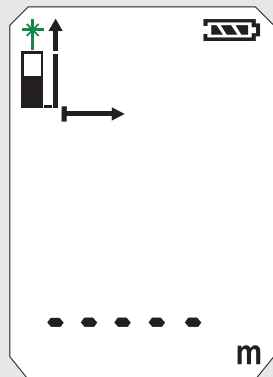

1

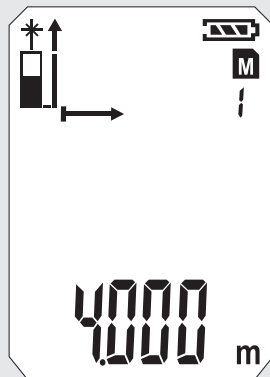
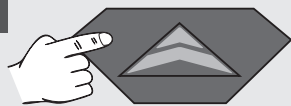

2

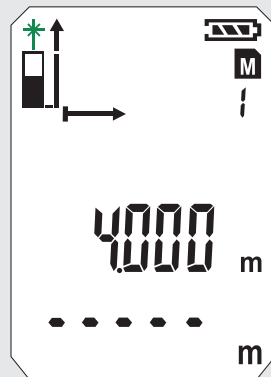
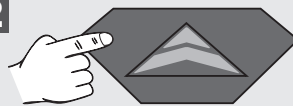

3

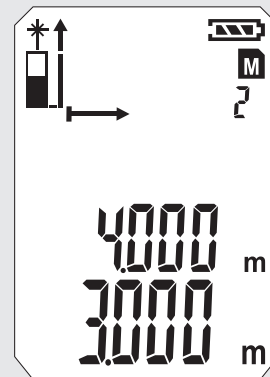
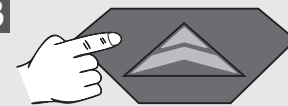

4

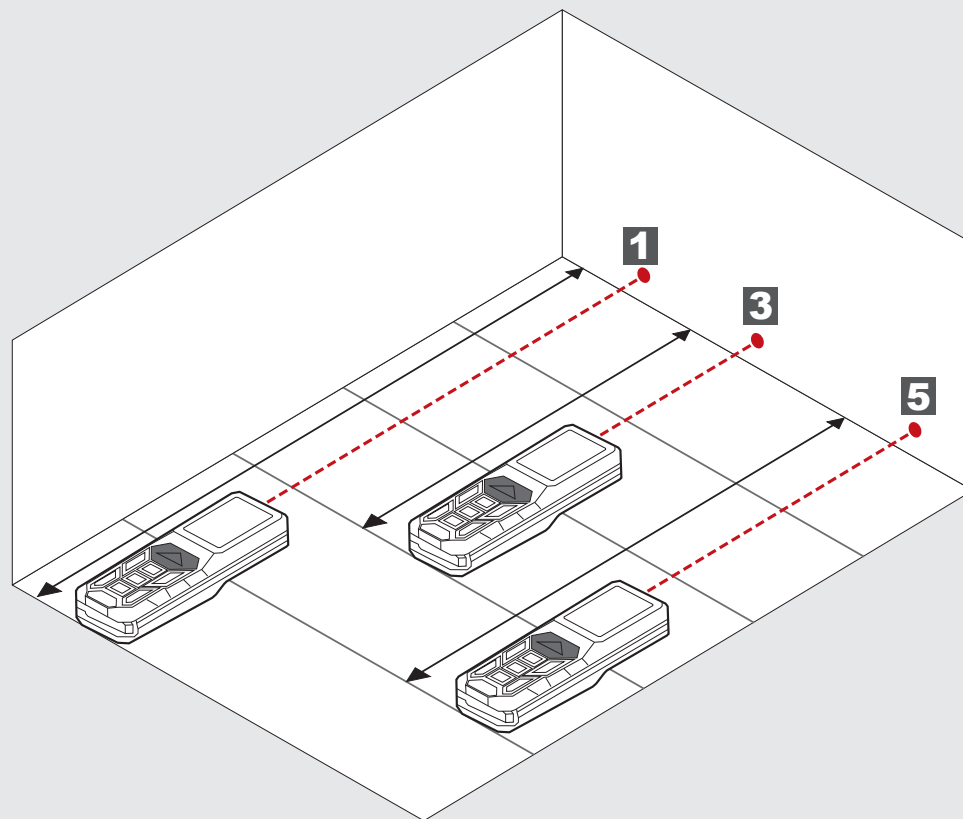
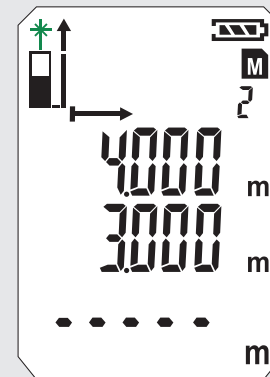
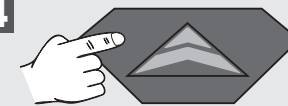

5

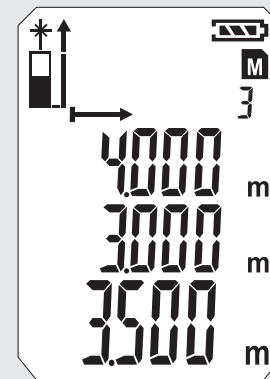
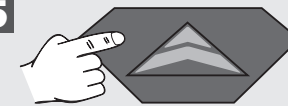

NEPĀRTRAUKTĀ MĒRĪŠANA/ MINIMUMA-MAKSIMUMA MĒRĪŠANA

0

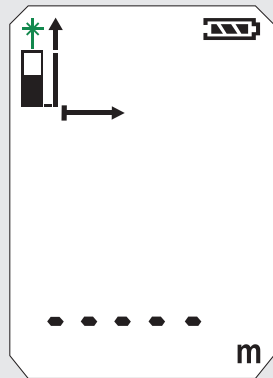

1

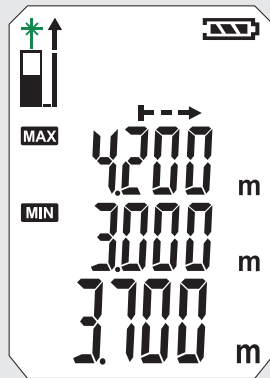
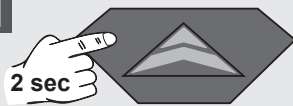

2

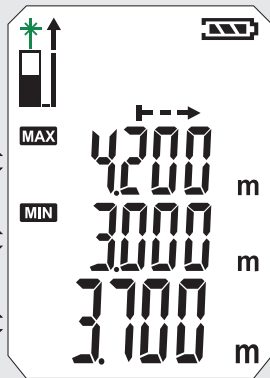

3

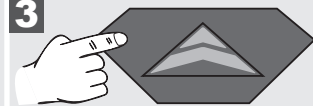

Stop
MIN / MAX

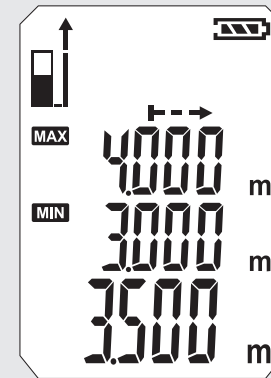

4

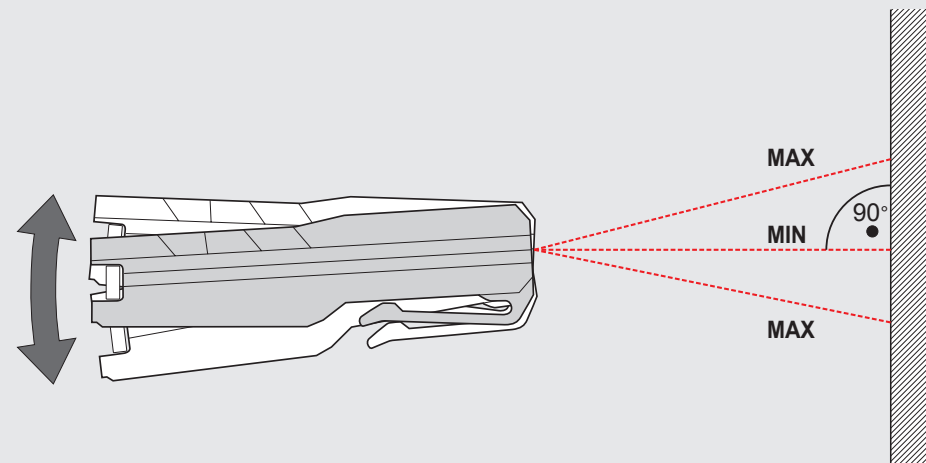
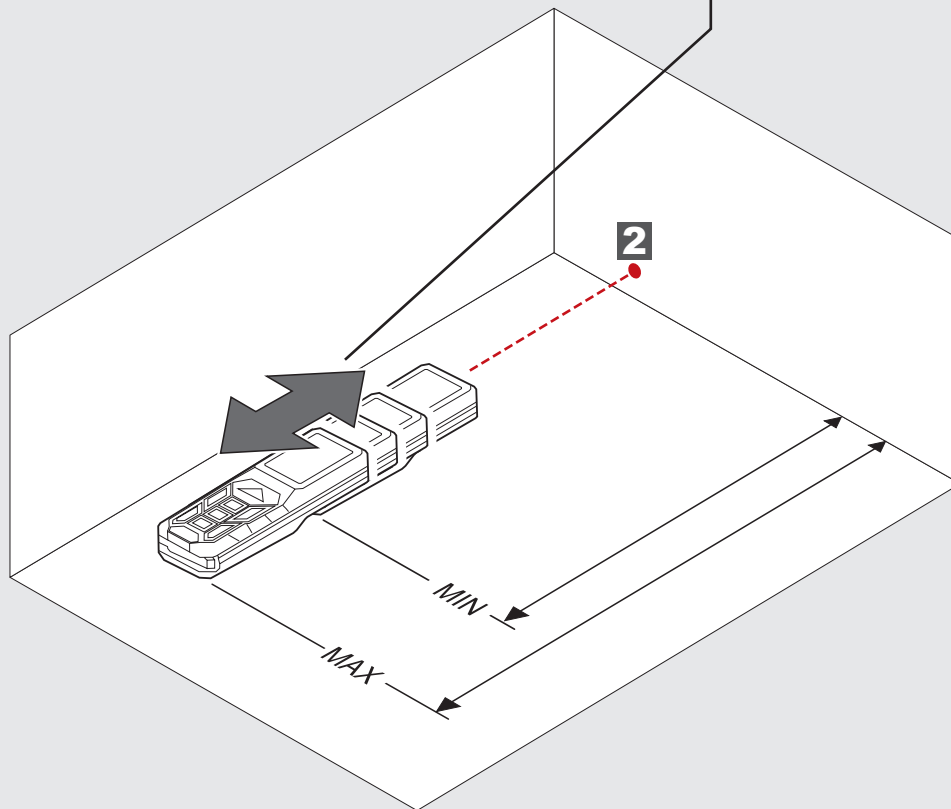
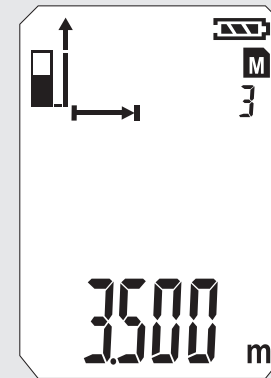
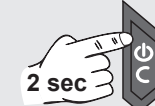

0

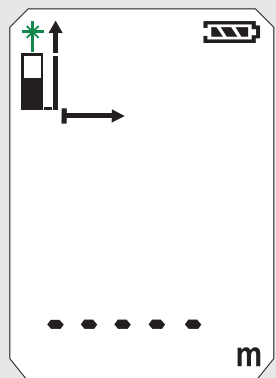

1

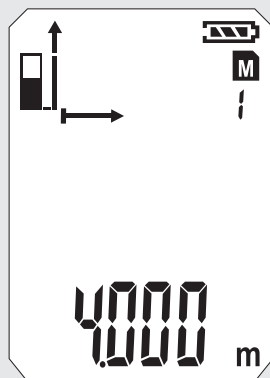
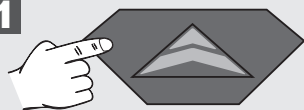

2

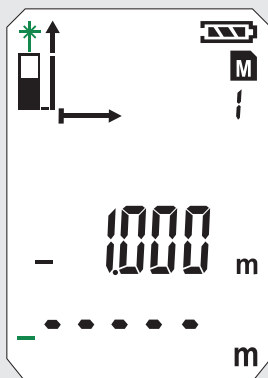
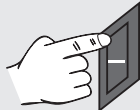

3

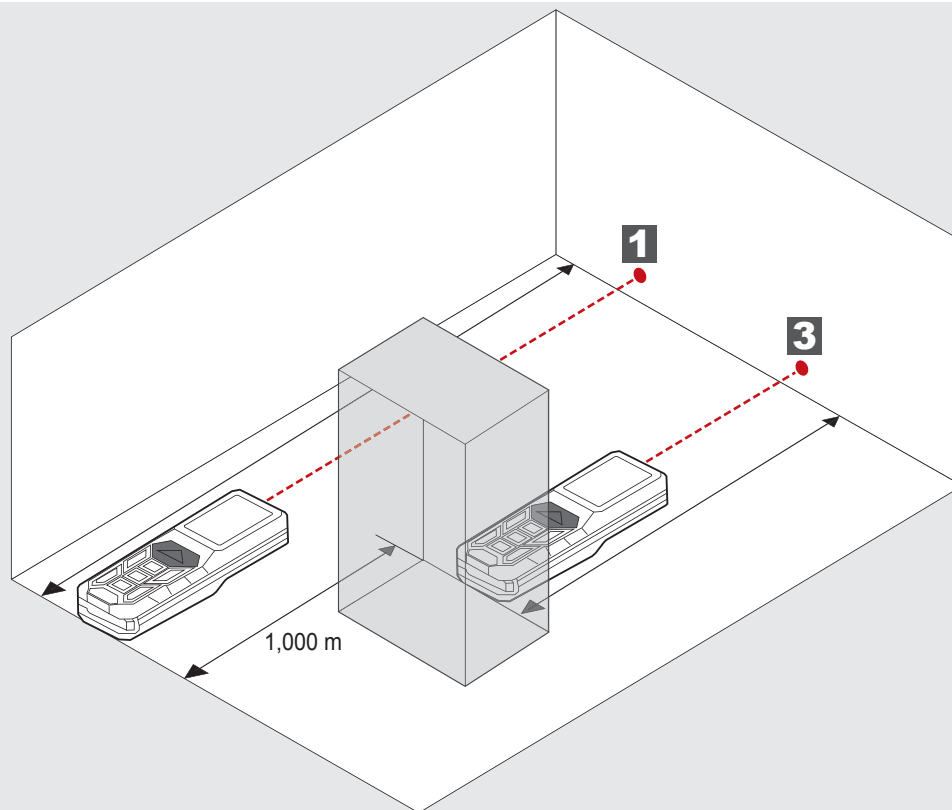
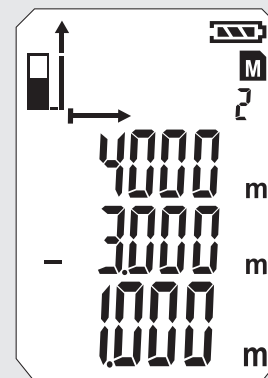
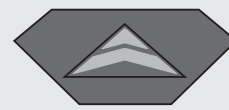

LAUKUMA MĒRĪŠANA

0



1

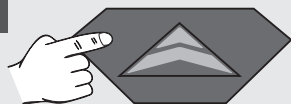

2

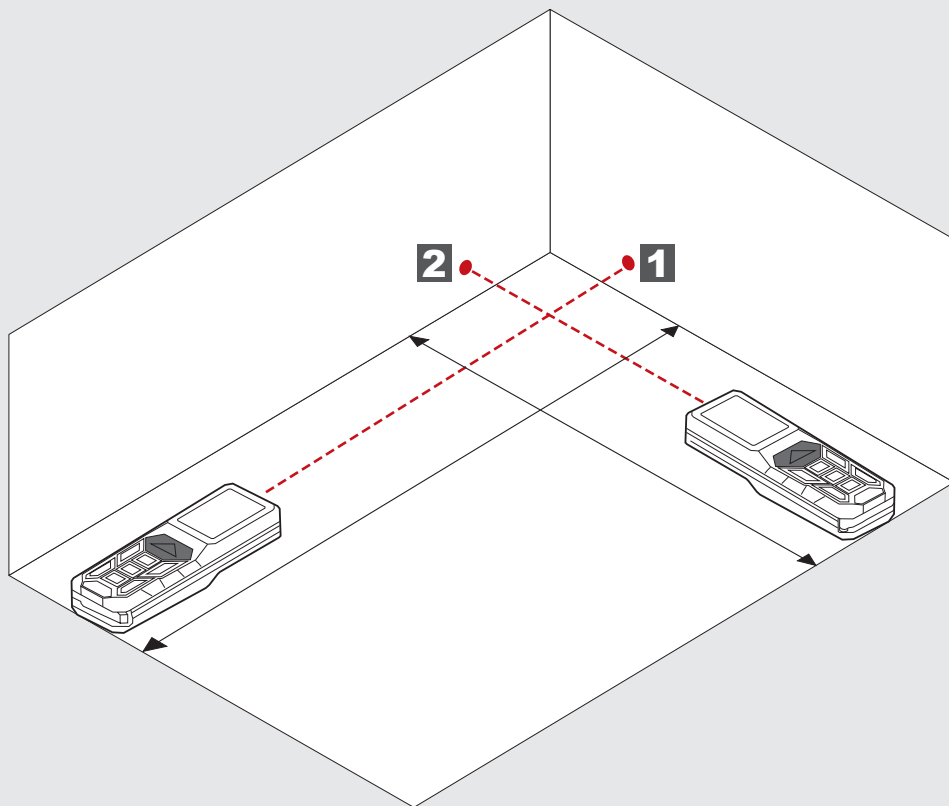
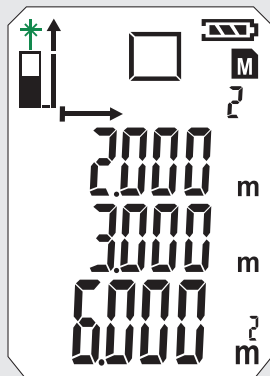
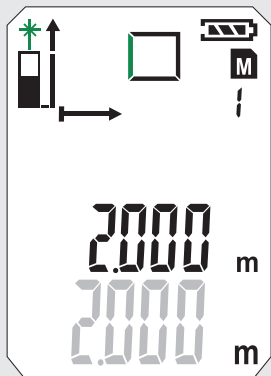
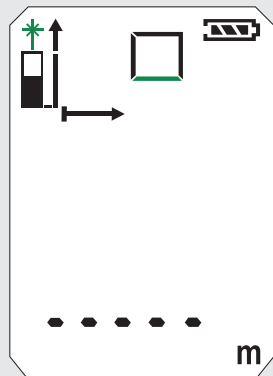
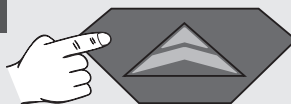

0



1

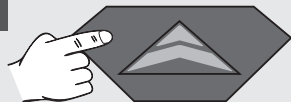

2

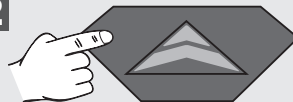

3

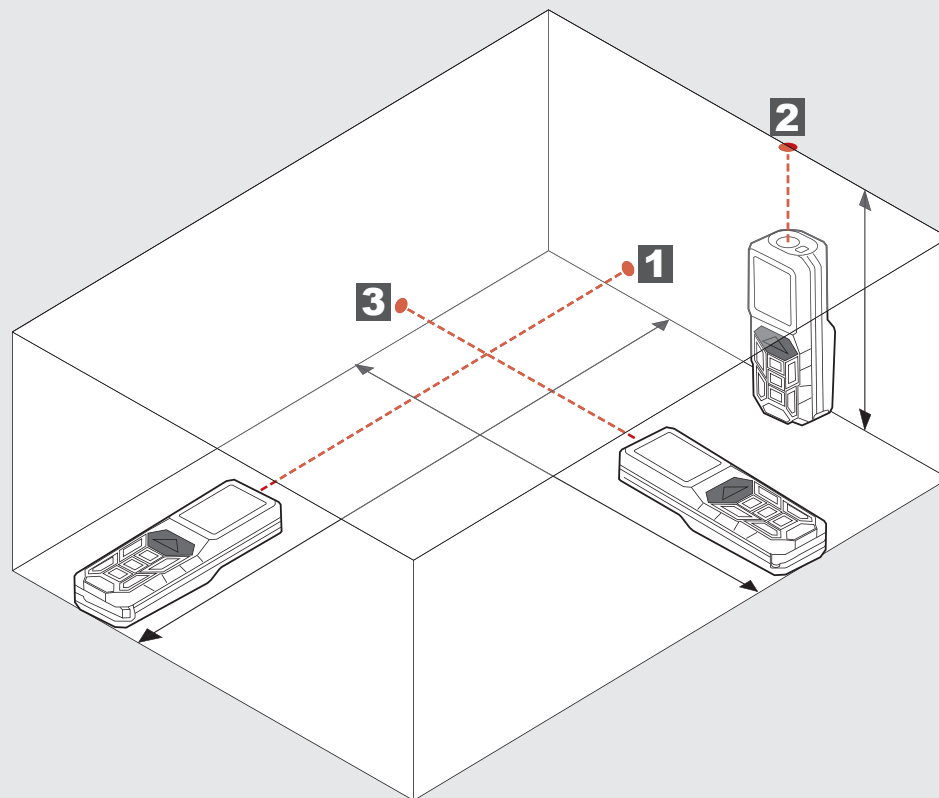
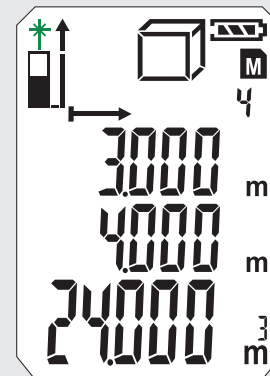
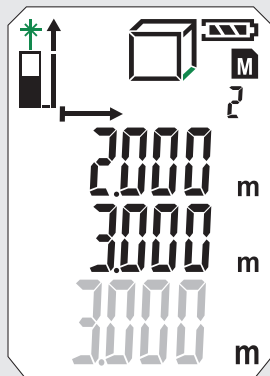
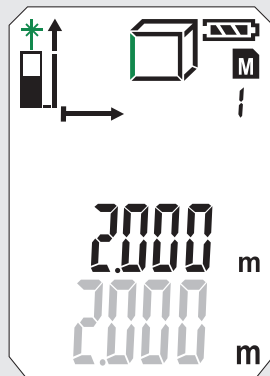
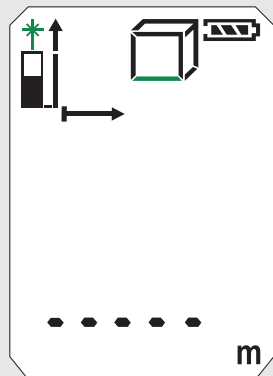
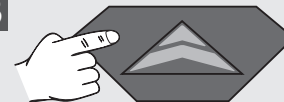

NETIEŠĀ MĒRĪŠANA (PITAGORS 1)

0



1

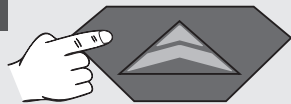

2

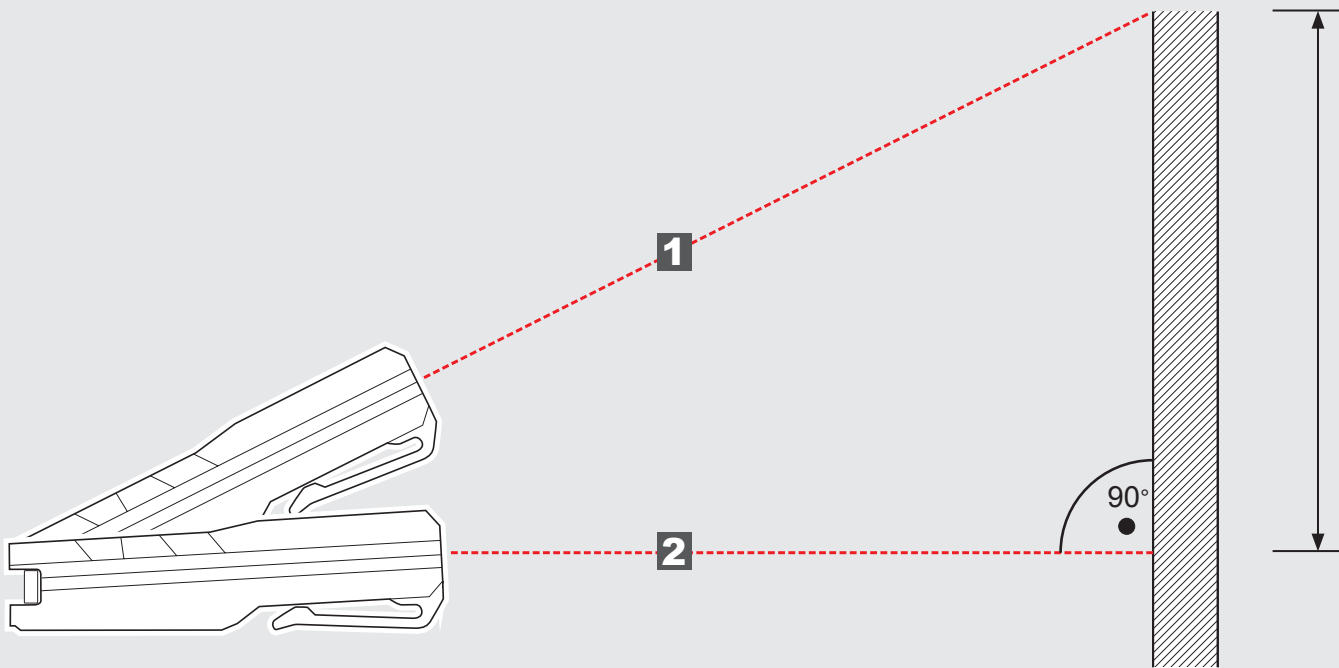
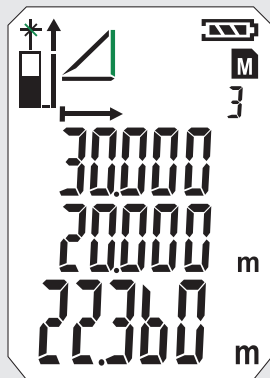
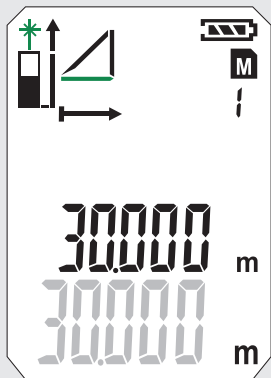
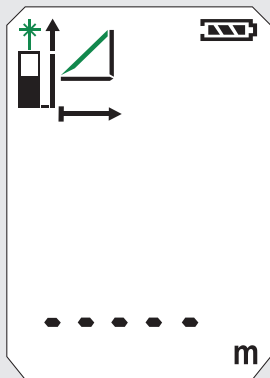
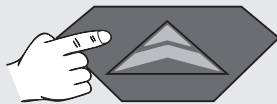

NETIEŠĀ MĒRĪŠANA (PITAGORS 2)

0



1

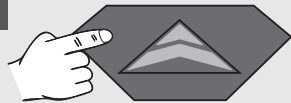

2

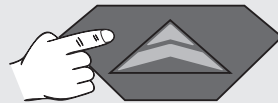

3

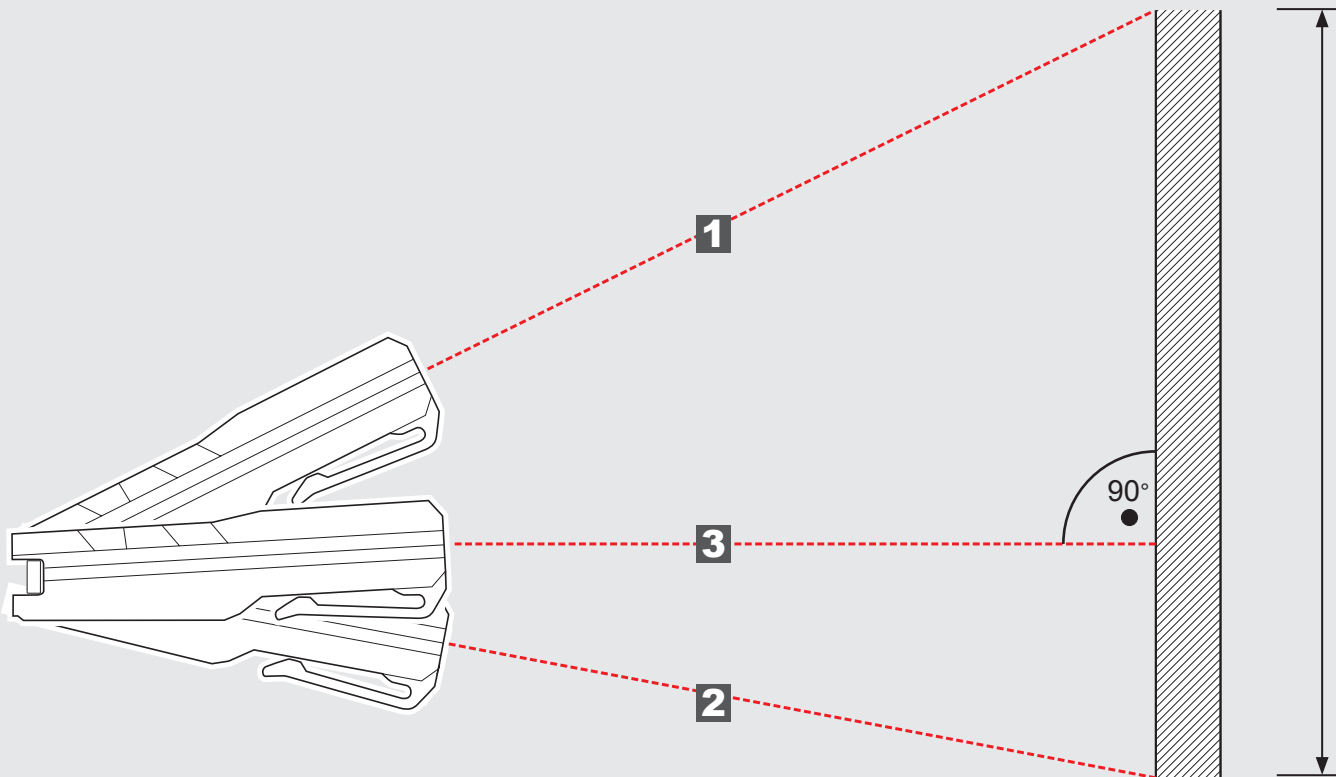
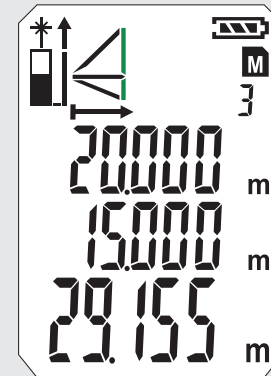
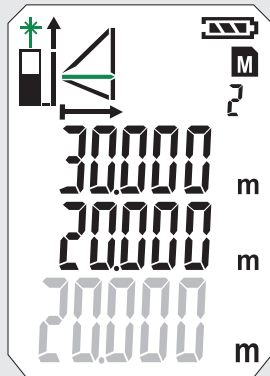
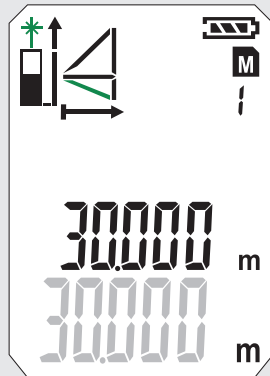
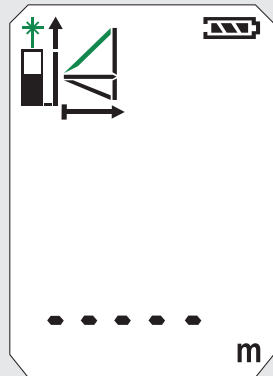
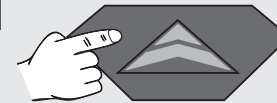

NETIEŠĀ MĒRĪŠANA (PITAGORS 3)

1



2

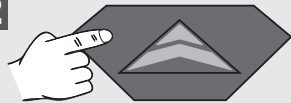



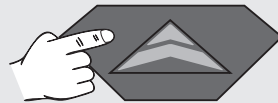

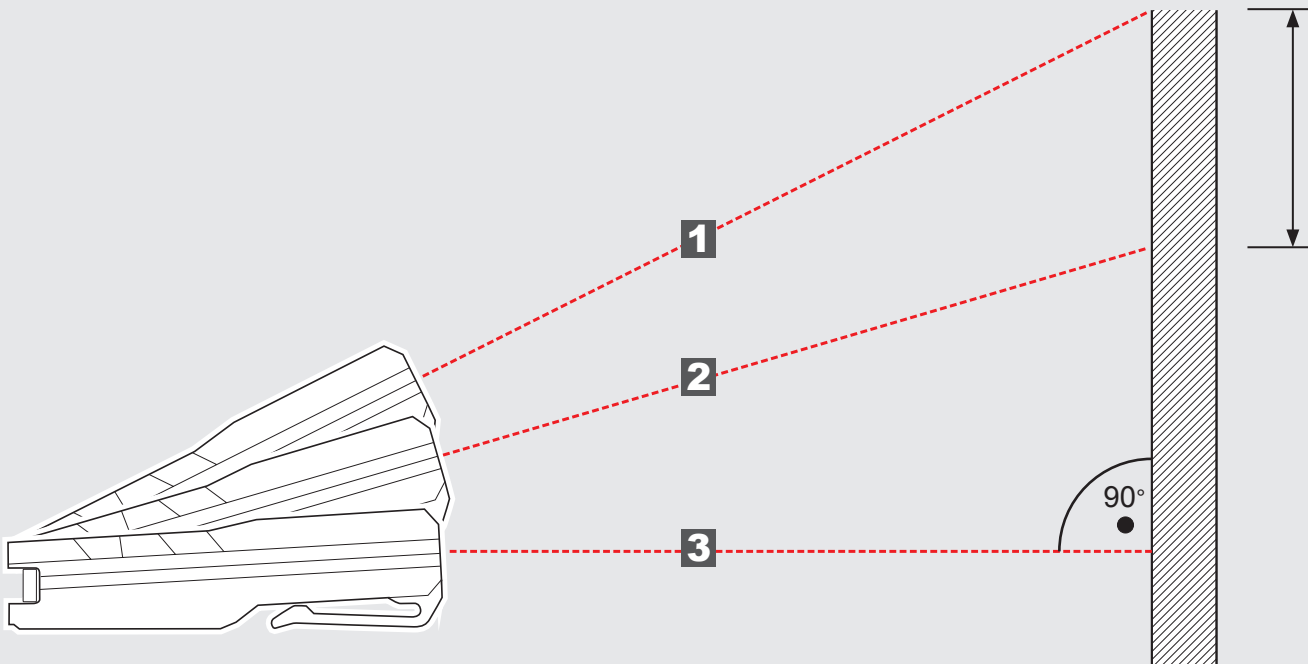
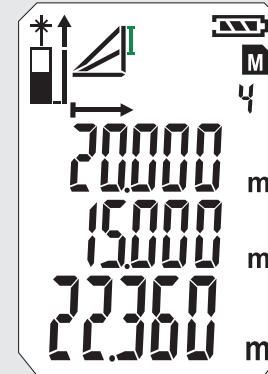
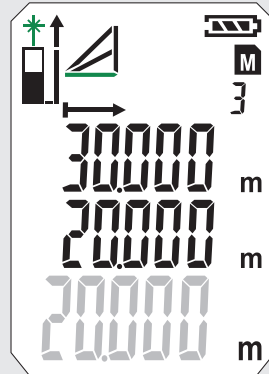
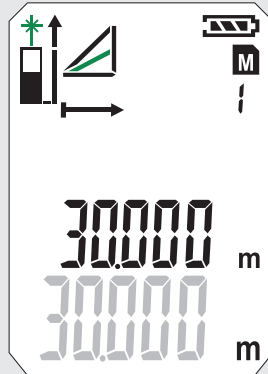
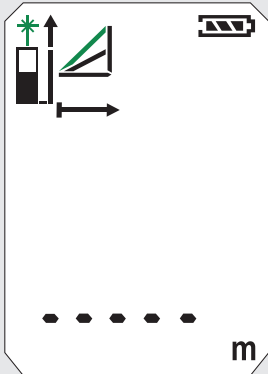
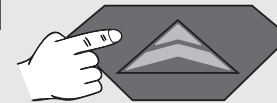

3



4

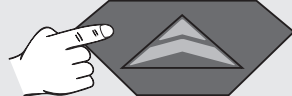
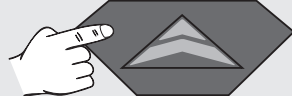

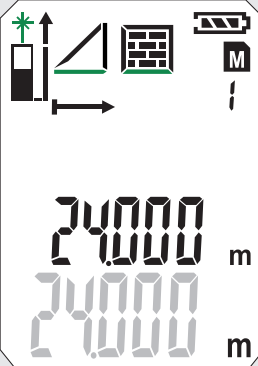
SIENAS LAUKUMA MĒRĪŠANA (2. VARIANTS)

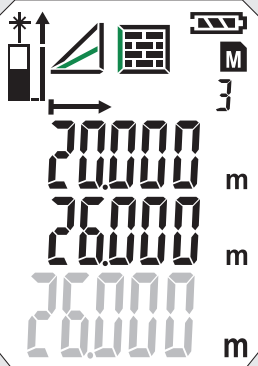
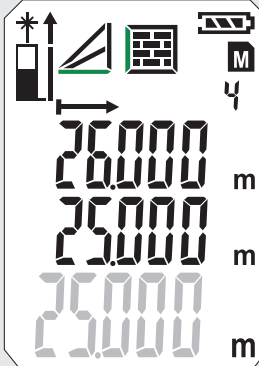
0 	1 	2 	3 	4 
				

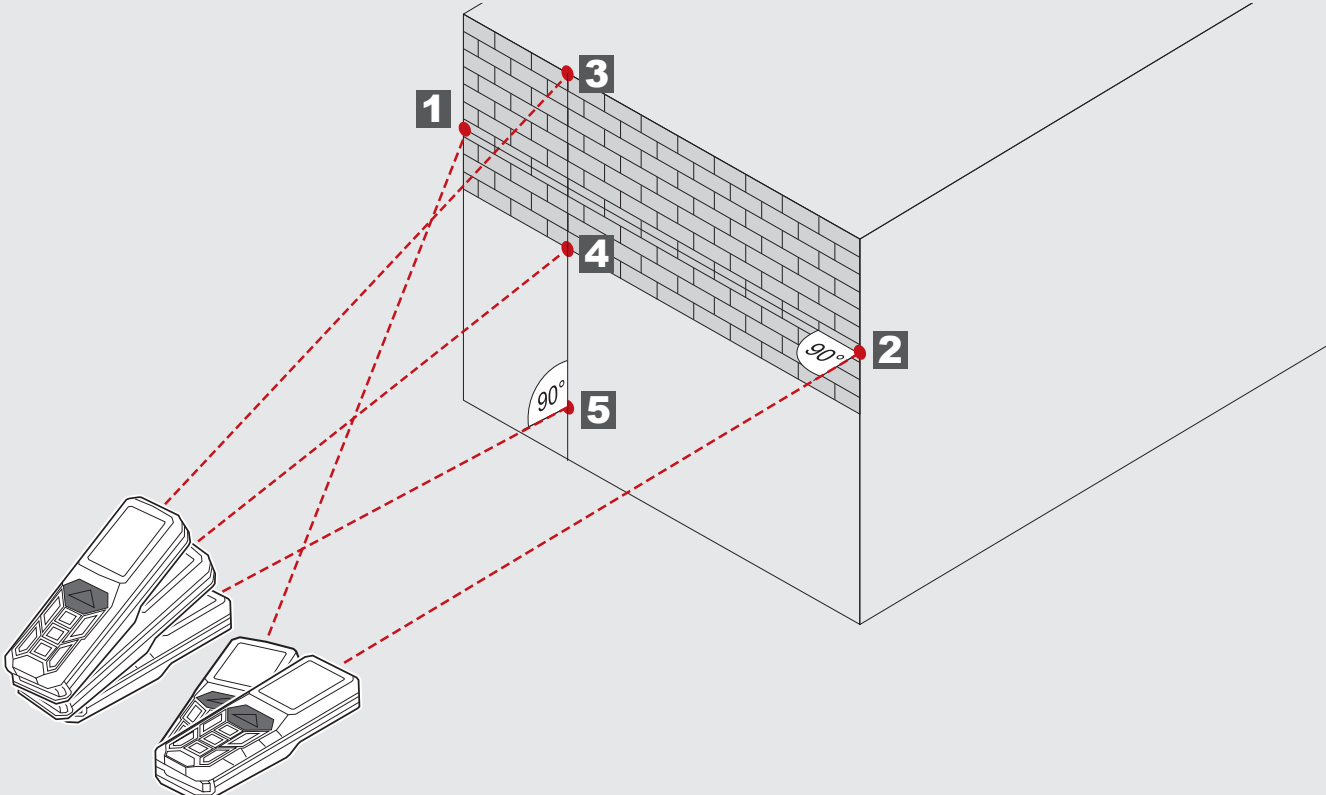

5



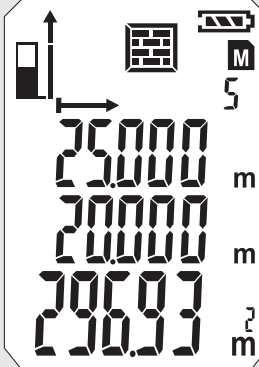



TAIMERIS

Ar taimera palīdzību ir iespējams sākt mērījumu ar aizturi, piemēram, lai mērījuma starā noliktu būvobjektu.

Nospiest taustiņu 

- Parādās simbols  Spiežot taustiņu  taimeri ir iespējams iestatīt no 3 līdz 15 sekundēm.

Nospiest taustiņu 

- Tiek uzsākta laika atskaite līdz mērījuma veikšanai.
- Sasniedzot 0, tiek veikts mērījums.

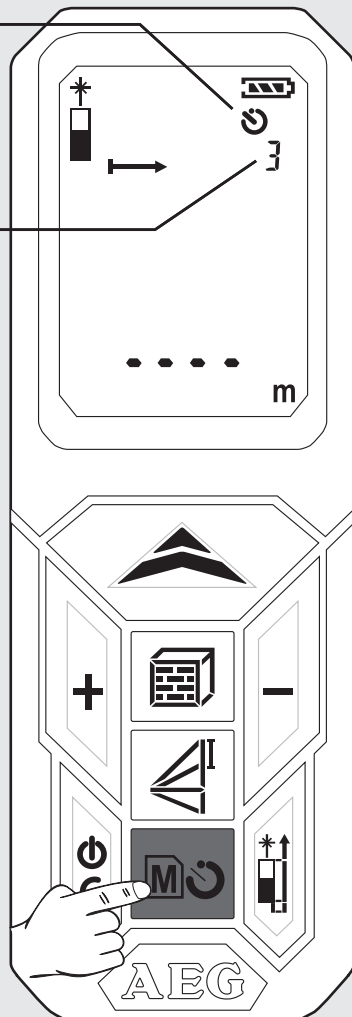

ATMIŅA

Mērījumu vērtības automātiski un secīgi tiek saglabātas atmiņā.

Saglabātās vērtības ir iespējams apskatīties, nospiežot taustiņu .

Turēt taustiņu  2 sekundes

- Parādās simbols un ieraksta numurs.
- Tiek attēlots attiecīgā mērījuma vērtība.
- Saglabātā vērtība tiek attēlota galvenajā līnijā.
- Pārvietojieties, izmantojot taustiņus +/-

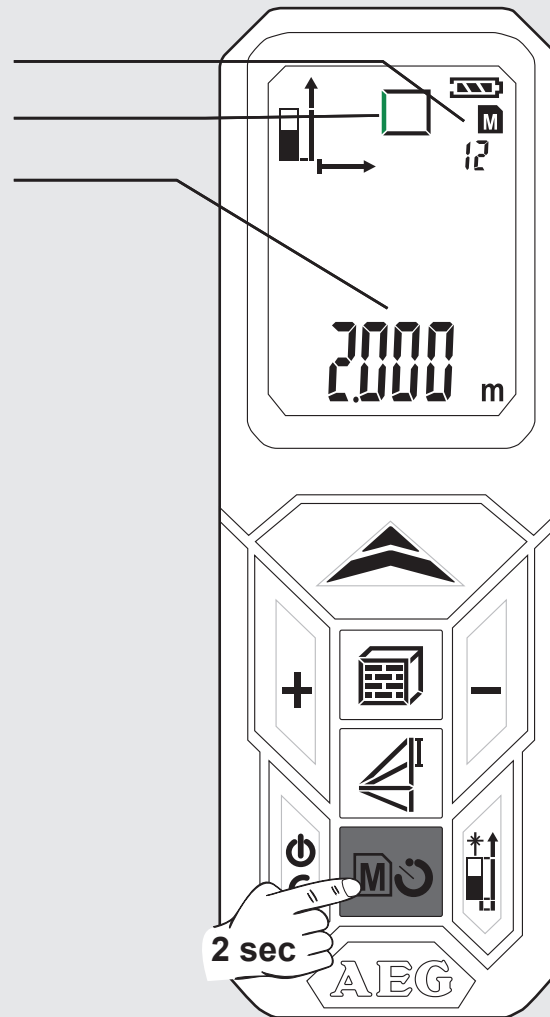



PAMATA DARBĪBAS UZ VIRSMAS MĒRĪJUMA PAMATA (1)

1 Ieslēgt

Nospieš taustiņu .
⚠ Uzmanību! Ieslēgts lāzera stars!
 Nevērst pret cilvēkiem!

2 Izvēlēties mērījuma līmeni

Noklusējuma izvēle ieslēdzot ierīci:
 aizmugure

 1x nospiežot -> stūra kāja
 2x nospiežot -> priekša
 3x nospiežot -> aizmugure

3 Izvēlēties funkciju

Ieslēdzot ierīce vienmēr atrodas
 garuma mērīšanas režīmā.

 1x nospiežot - laukuma
 mērīšana

4 Garuma mērīšana

Novietot ierīci un
 nospieš taustiņu 

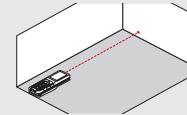

5 Platuma mērīšana

Novietot ierīci un
 nospieš taustiņu 

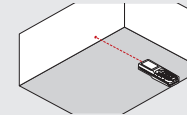

Mirgo lāzera simbols
 (attēlots zaļā krāsā).

Tiek attēlots simbols

- Parādās simbols
 - Mērāmais apgabals mirgo
 (attēlots zaļā krāsā)

- Izmērītā vērtība uz īsu brīdi parādās
 galvenajā līnijā.
 - Pēc 1 sekundes izmērītā vērtība
 pārvietojas uz augstāk esošo līniju.
 - Izmērītā vērtība tiek saglabāta atmiņā
 ar kārtas numuru.
 - Mirgo otra mērāmā apgabala simbols.
 Ierīce ir gatava otra mērījuma
 veikšanai.

- Izmērītā vērtība uz īsu brīdi parādās
 galvenajā līnijā.
 - Pēc 1 sekundes izmērītā vērtība
 pārvietojas uz augstāk esošo līniju.
 - Izmērītā vērtība tiek saglabāta atmiņā
 ar kārtas numuru.
 - Iznākums tiek parādīts galvenajā līnijā
 un saglabāts atmiņā ar kārtas numuru.

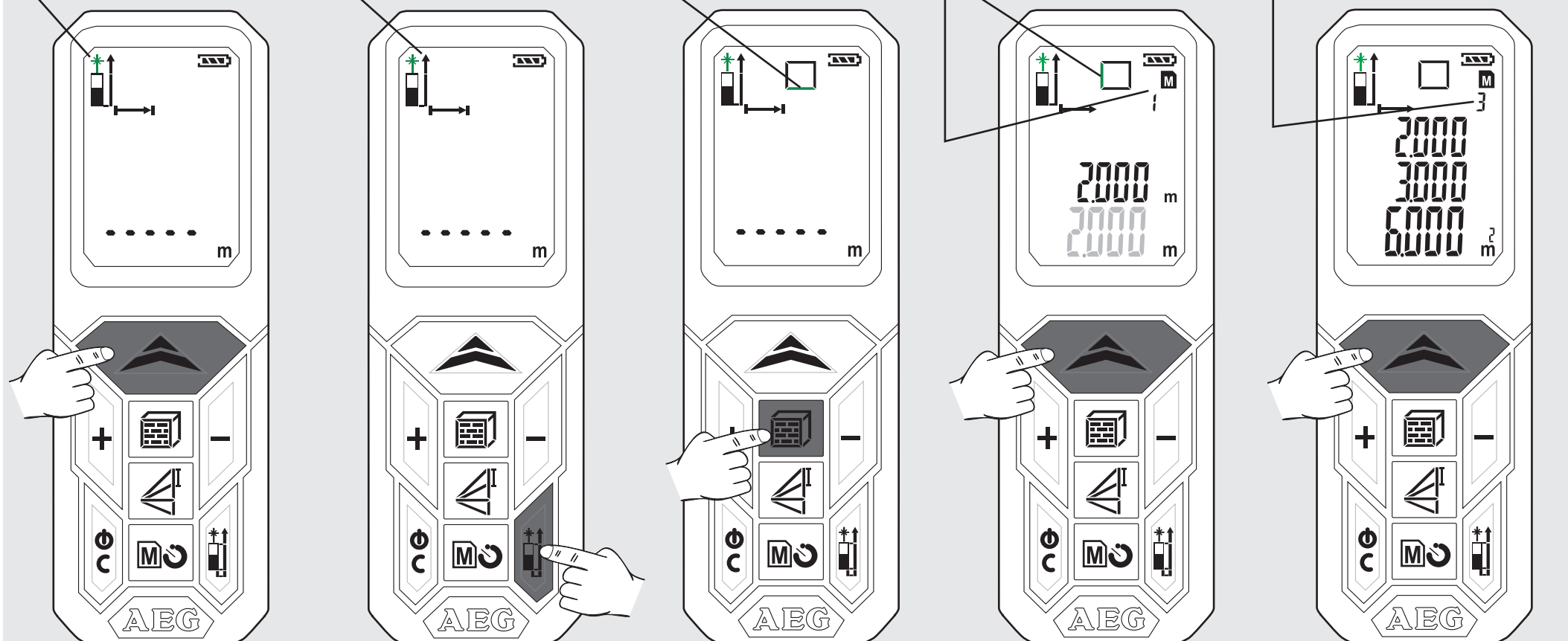

PAMATA DARBĪBAS UZ VIRSMAS MĒRĪJUMA PAMATA (2)

6 Attēlot saglabātās vērtības

Turēt taustiņu  2 sekundes.
Nospieš taustiņus + vai -

7 Iziet no atmiņas

Nospieš taustiņu 

8 Izslēgt

Turēt taustiņu  2 sekundes
(Pirms tam ir jāiziet no atmiņas).

- Saglabātās vērtības tiek attēlotas galvenajā līnijā.

Tiek attēlots attiecīgais simbols, un mērāmais apgabals mirgo (attēlots zaļā krāsā).

- Ierīce izslēdzas.

- Ja 3 minūšu laikā netiek nospiests neviens taustiņš, ierīce izslēdzas automātiski.

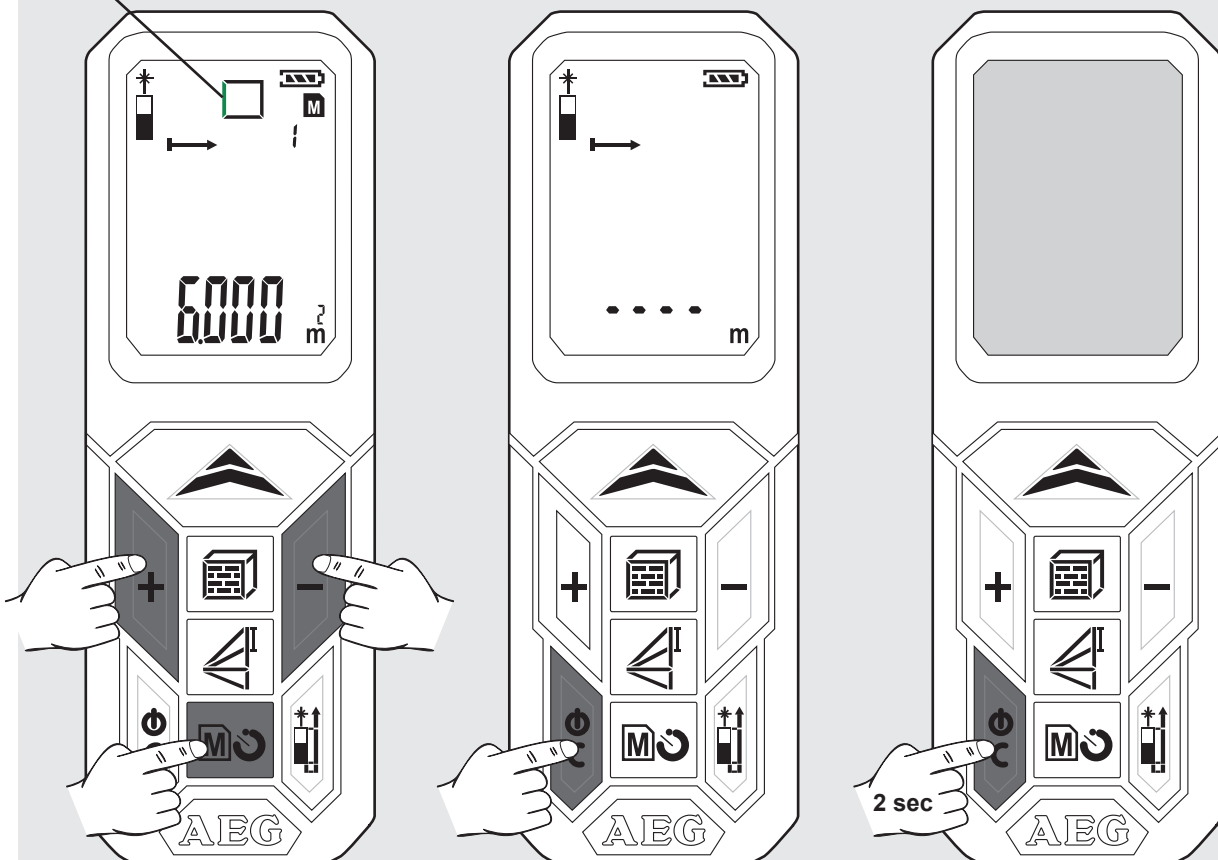

TURINYS

Svarbios saugumo instrukcijos1
 Techniniai duomenys2
 Naudojimas pagal paskirtį2
 Gedimų kodų lentelė.....2
 Apžvalga3
 Baterijos pakeitimas4
 Kampinis kaištis.....4
 Diržo laikiklis.....4
 Funkcinis mygtukas, Pitagoras, matavimo lygis5
 Paprastas ilgių matavimas.....6
 Tęstinis matavimas / min. ir maks. matavimas7
 Suminis / išskaičiuojamas matavimas8
 Ploto matavimas9
 Tūrio matavimas10
 Netiesioginis matavimas (Pitagoras 1)11
 Netiesioginis matavimas (Pitagoras 2)12
 Netiesioginis matavimas (Pitagoras 3)13
 Sienelės ploto matavimas (1 scenarijus).....14
 Sienelės ploto matavimas (2 scenarijus).....15
 Laikmatis16
 Atmintis.....16
 Su pagrindinės funkcijos ploto matavimo pavyzdžiu (1).....17
 Su pagrindinės funkcijos ploto matavimo pavyzdžiu (2).....18

SVARBIOS SAUGUMO INSTRUKCIJOS

 Nenaudokite produkto, jei neperskai- tėte saugumo instrukcijų ir vartotojui skirto eksploatacijos vadovo, pridė- tame kompaktiniame diske.

Lazerio klasifikavimas

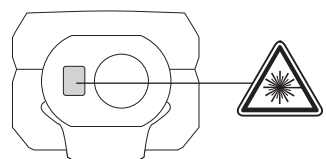

ĮSPĖJIMAS:
 Tai **2-osios klasės** lazerinis produktas, kuriam taikomi IEC 60825-1:2007 saugumo reikalavimai.



Ženklimas

Prieš pradėdami eksploatuoti, užklijuokite pridėtą lipduką valstybine kalba ant teksto anglų kalba duomenų lentelėje.

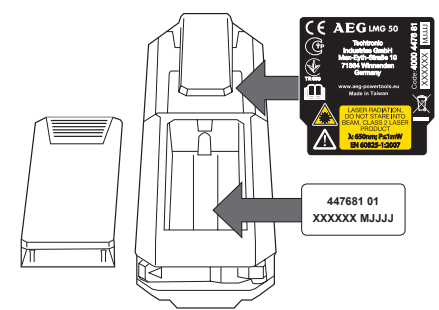

Įspėjimas:
 Venkite tiesioginio vizualaus kontakto. Lazerio spinduliai gali apakinti ir sukelti trumpalaikį apakimą.

Nežiūrėti į lazerio skleidžiamą spindulį ar be priežasties nukreipti jį į kitus žmones.

Juo negalima apakinti.

Įspėjimas:
 Nenaudokite lazerinio prietaiso, jei šalia yra vaikų ir neleiskite vaikams patiems naudotis šiuo lazeriniu prietaisu.

Dėmesio! Atspindintis paviršius gali nukreipti lazerio spindulį atgal į vartotoją arba kitus asmenis.

Savo galūnes laikykite saugiu atstumu nuo judančių dalių.

Periodiškai atlikti bandomuosius matavimus. Ypač jei atliksite, atliekate ar atlikote svarbius matavimus.

Jei produktas sugedęs ar buvo nukritęs, neteisingai panaudotas ar rekonstruotas, jo parodymai gali būti klaidingi.

Dėmesio! Susipažinkite su sodo priežiūros įrankio valdymo elementais bei išmokite tinkamai juo naudotis.

Lazerinio matavimo prietaiso pritaikymo sritis yra apribota. (Žr. skyrių „Techniniai duomenys“). Bandymai matuoti už maksimalios ir minimalios zonos ribų sukelia netikslumų. Naudojant sudėtingomis sąlygomis, pavyzdžiui, kai per karštą, per šaltą, per daug intensyvi saulės šviesa, lyja, sninga, rūkas ar kitomis matymą apsunkinančiomis sąlygomis, galimi matavimų netikslumai.

Jei lazerinis matavimo prietaisas perkeliamas iš šiltos aplinkos į šaltą (arba atvirkščiai), palaukite, kol prietaisas prisitaikys prie naujos aplinkos temperatūros.

Lazerinį matavimo prietaisą laikykite visada patalpų viduje, prietaisą saugokite nuo sukrėtimų, vibracijų ar ribinių temperatūrų.

Lazerinį matavimo prietaisą saugokite nuo dulkių, drėgmės ir didelės oro drėgmės. Tai gali pažeisti vidines konstrukcines dalis arba turėti įtakos matavimų netikslumui.

Nenaudokite agresyvių valiklių ar tirpiklių. Valykite tik švaria, minkšta šluoste.

Venkite stiprių smūgių, saugokite, kad lazerinis matavimo prietaisas nenukristų. Prietaiso tikslumas turi būti iš naujo patikrintas, jeigu jis nukrito ar patyrė mechanines apkrovas.

Būtinus šio lazerinio prietaiso remonto darbus gali atlikti tik įgaliotas kvalifikuotas personalas.

Neekspluatuokite produkto sprogioje ar agresyvioje aplinkoje.

Baterijoms įkrauti naudokite tik gamintojo rekomenduojamus įkroviklius.

 Išsikrovusias baterijas draudžiama išmesti su buitinėmis atliekomis. Rūpinkitės aplinka ir nuneškite jas į surinkimo punktą, vadovaudamiesi valstybiniais arba vietiniais nuostatais. Produktą draudžiama išmesti su buitinėmis atliekomis. Produktą utilizuokite adovaudamiesi šalyje galiojančiais nuostatais. Laikykitės valstybinių ir regioninių nuostatų. Jei norite gauti detalesnę informaciją apie utilizavimą, kreipkitės į vietos įstaigą arba į savo prekybos atstovą.



TECHNINIAI DUOMENYS

Apsaugos klasė	IP54 (apsauga nuo dulkių ir vandens pusrų)
Optika	14 mm
Degimo taškas	35 mm
Matavimo sritis maks.	50 metrų (paklaida: 55 m)
Matavimo sritis min.	0,05 metro
Absolūtus tikslumas @ < 10 m	± 1,5 mm (Maks.)
Kartotinis tikslumas @ < 10 m	± 1,5 mm (tipinis maks. 2σ)
Kartotinis tikslumas @ > 10 m	pakilimas ± 0,25 mm / metro (tipinis maks. 2σ)
Matavimo laikas	0,5 s
Ekrano tipas	LCD (22,7 mm x31 mm)
Elektros energijos tiekimas	AAA 2x (šarminės baterijos)
Baterijos eksploatavimo trukmė	10 000 (pavienis matavimas)
Lazerio galia ties išvadu	0,6 mW ~ 0,95 mW (klasė 2, 650 nm)
Lazerio taško dydis	25x30 mm @ 16 m (Maks.)
Lazerio spindulio vertikalus kampas	+1 laipsnis
Lazerio spindulio horizontalus kampas	±1 laipsnis
Automatinis prietaiso išsijungimas	180 sekundžių
Automatinis lazerio išsijungimas	30 Sekundžių
Darbinės temperatūros diapazonas	-10 °C iki +50 °C
Laikymo temperatūros diapazonas	-25 °C iki +70 °C
Svoris be baterijos	80 g

NAUDOJIMAS PAGAL PASKIRTĮ

Lazerinis matavimo prietaisas skirtas matuoti atstumus ir polinkius.

Šį prietaisą leidžiama naudoti tik pagal nurodytą paskirtį.

GEDIMŲ KODŲ LENTELĖ

Kodas	aprašymasg	sprendimas
Err01	už matavimo srities ribų	Matavimą atlikti numatytoje zonoje.
Err02	Reflektuojantis signalas per silpnas	Pasirinkite geresnį paviršių.
Err03	Už indikacijų zonos (maks. vertė: 99.999)pvz., ploto ar tūrio rezultatas už indikacijos zonos ribų	Patikrinkite, ar vertės ir žingsniai teisingi.
Err04	Gedimas Pitagoro apskaičiavime	Patikrinkite, ar vertės ir žingsniai teisingi.
Err05	Baterija išsikrovusi	Įdėkite naują bateriją.
Err06	Už darbinės temperatūros zonos	Išmatuokite nustatytoje darbinės temperatūros zonoje.
Err07	Per stipri aplinkos šviesa	Užtemdykite matuojamą zoną.

Pitagoro aukščių skirtumas

Matavimo lygis

Ilgų matavimas

Tęstinio matavimo min./maks.

Sudėtis / išskaičiavimas

Plotas / tūris
netiesioginis ploto matavimas

Baterijos būseną

Atmintis

Laikmatis

Tęstinis matavimas

Tarpinės vertės

Bendra vertė

| / MATAVIMAS

- ▶ |
- ▶ Matavimas
- ▶ Tęstinis matavimas (2 sek. paspauskite) min./maks. funkcija

SUDĖTIS

- ▶ Vertę pridėkite
- ▶ Perkėlimas atmintyje

PLOTAS / TŪRIS

- ▶ Plotas (1x paspausti)
- ▶ Tūris (2x paspausti)
- ▶ Netiesioginis plotų matavimas (3x/4x paspausti)

|JUNGTI

- ▶ |
- ▶ Iš (2 sek. paspausti)
- ▶ Gražinti

IŠSKAIČIAVIMAS

- ▶ Vertės išskaičiavimas
- ▶ Perkėlimas akumuliatoriuje

PITAGORO

- ▶ Pitagoras 1 (1x paspausti)
- ▶ Pitagoras 2 (2x paspausti)
- ▶ Pitagoras 3 (3x paspausti)

MATAVIMO LYGIO PAKEITIMAS

- ▶ Priekyje
- ▶ Užpakalyje
- ▶ Kampinis kaištis

AKUMULIATORIUS

- ▶ Laikmatis 3-15 sek. (1x paspausti)
- ▶ Akumulatorius 1-20 (1x 2 sek. paspausti)
- ▶ Mygtukais +/- perkelti akumuliatoriuje

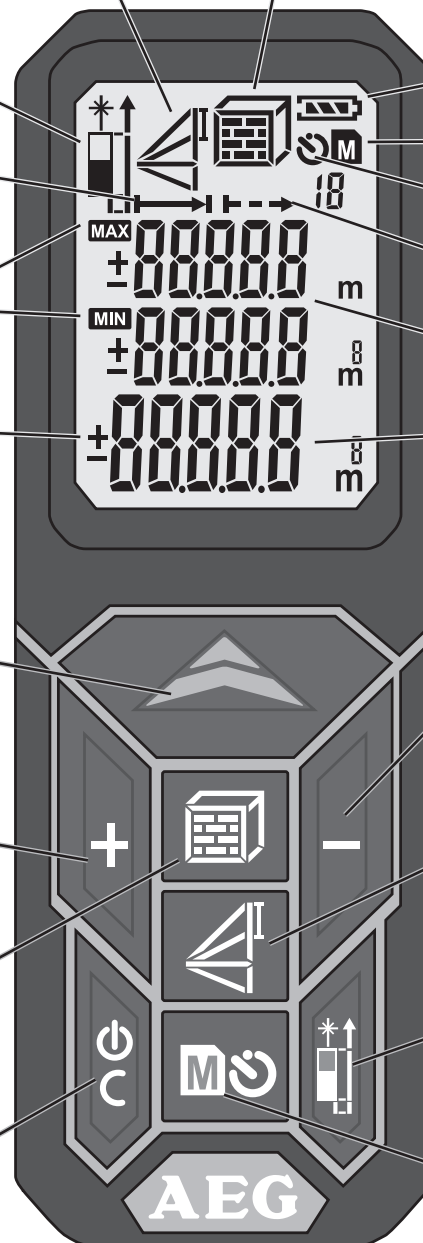

BATERIJOS PAKEITIMAS

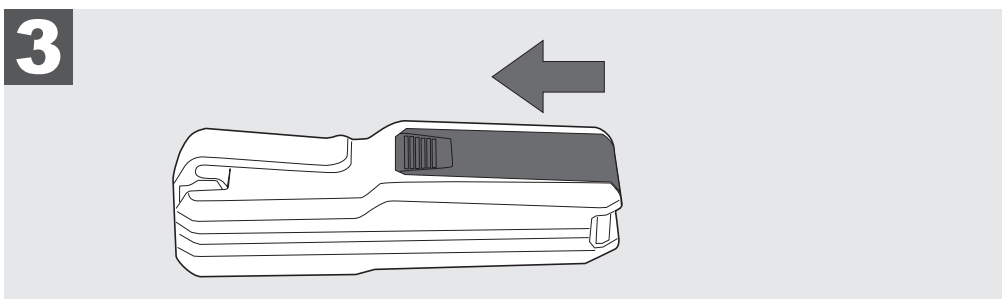
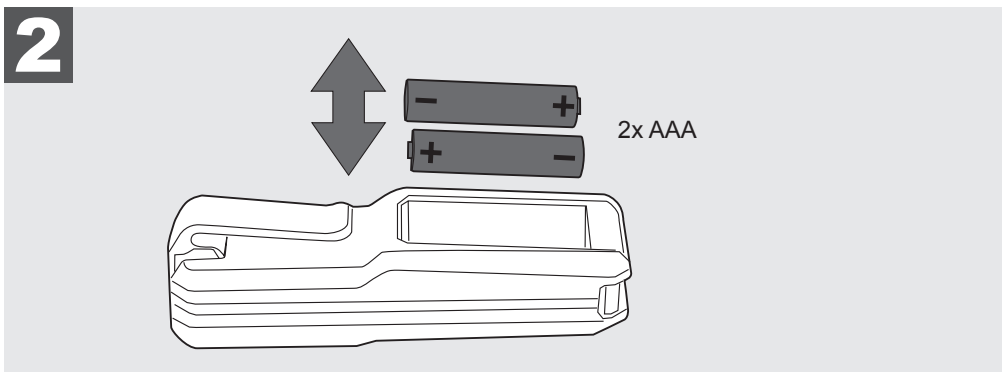
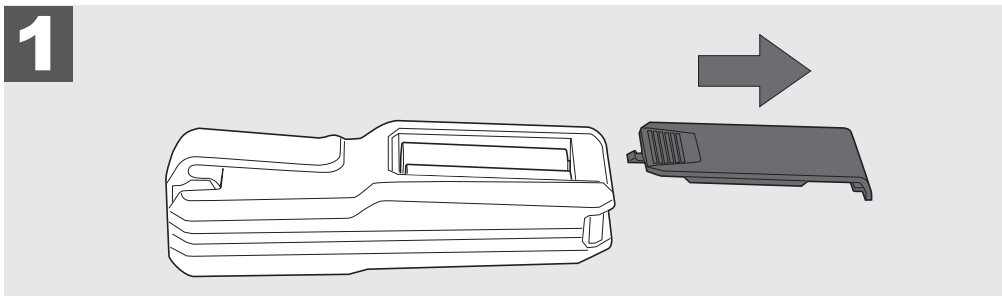
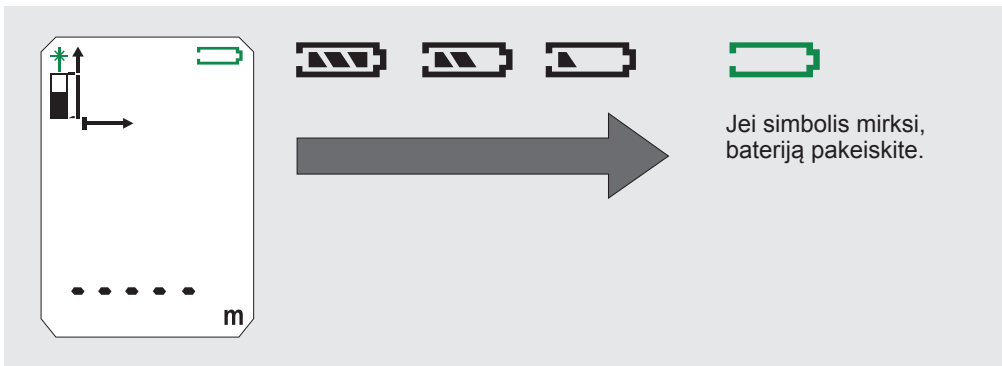

KAMPINIS KAIŠTIS

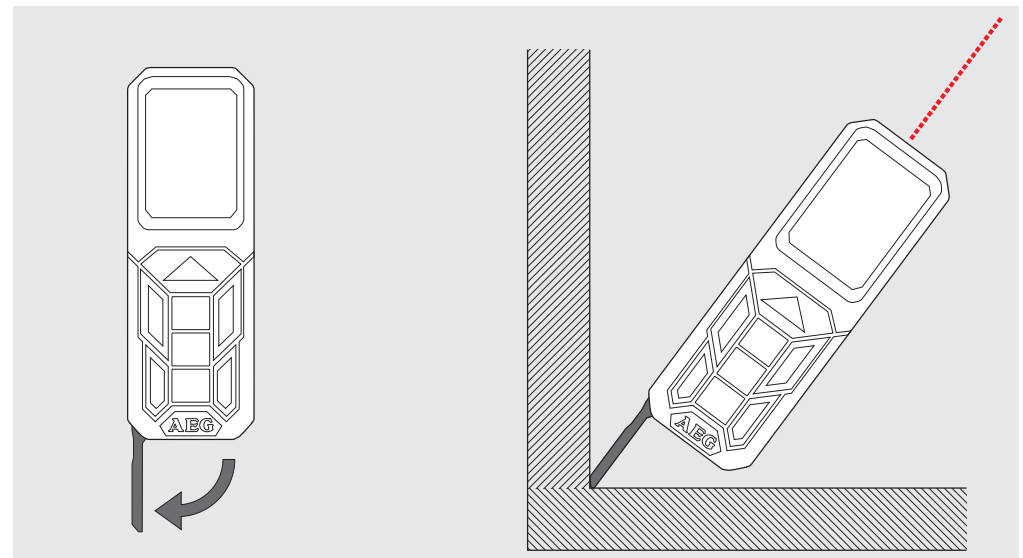

DIRŽO LAIKIKLIS

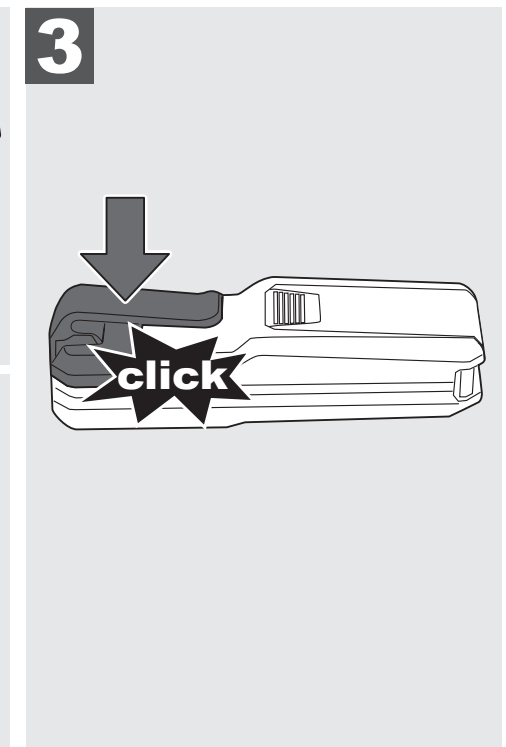
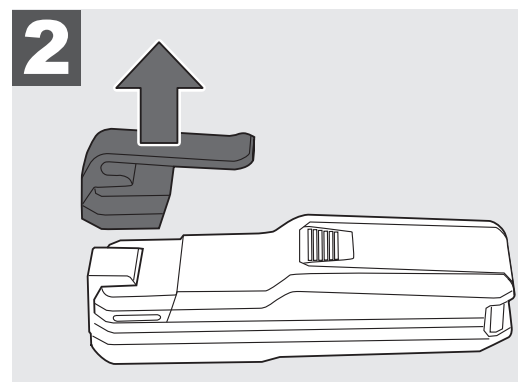
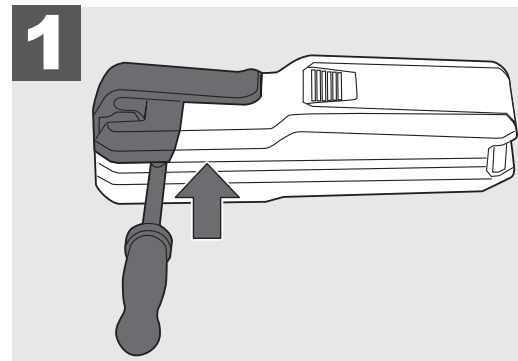

FUNKCINIS MYGTUKAS, PITAGORAS, MATAVIMO LYGIS

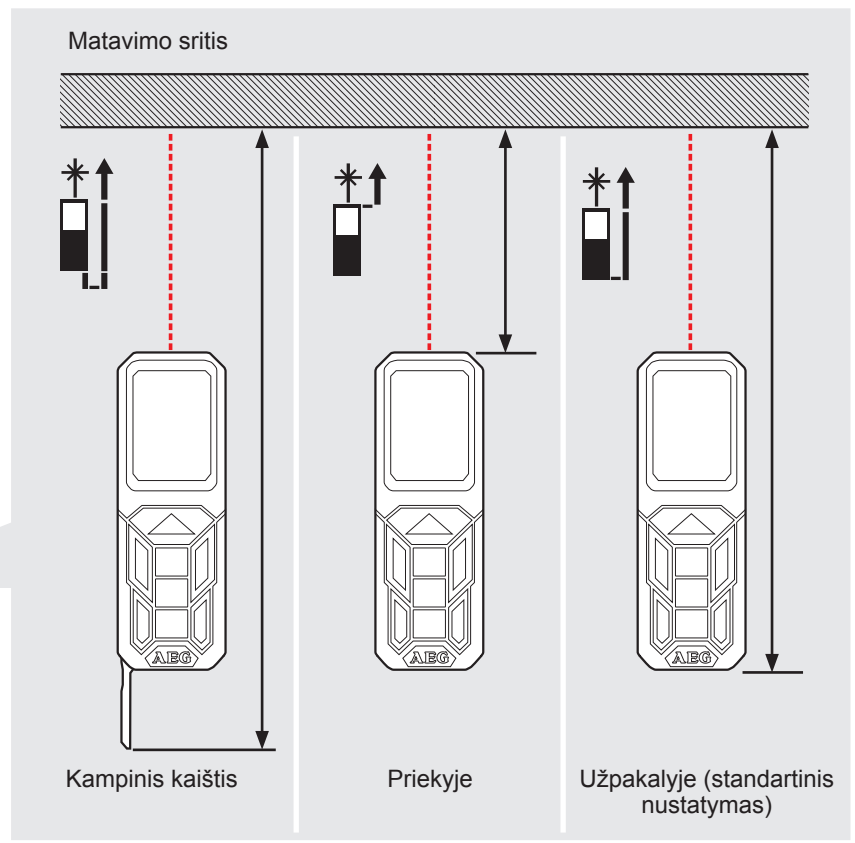
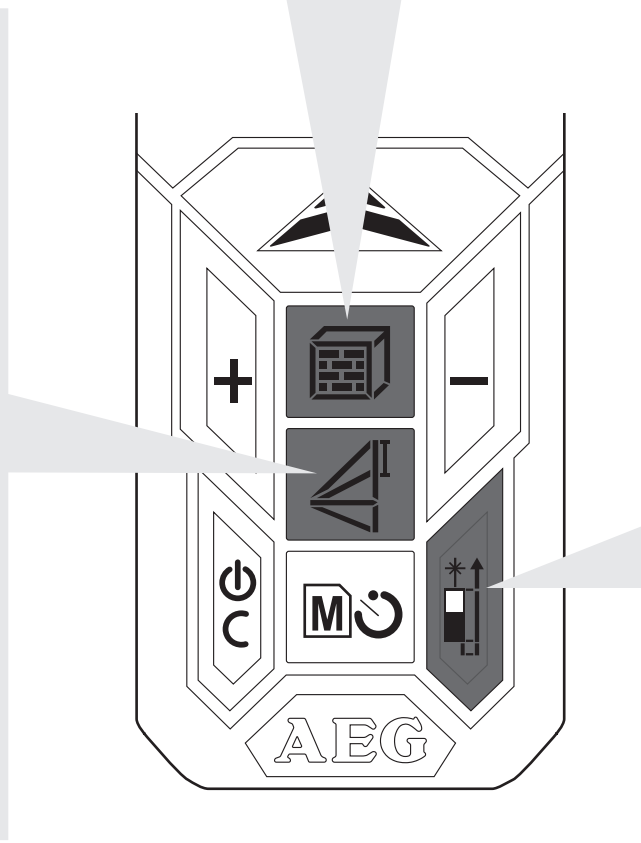
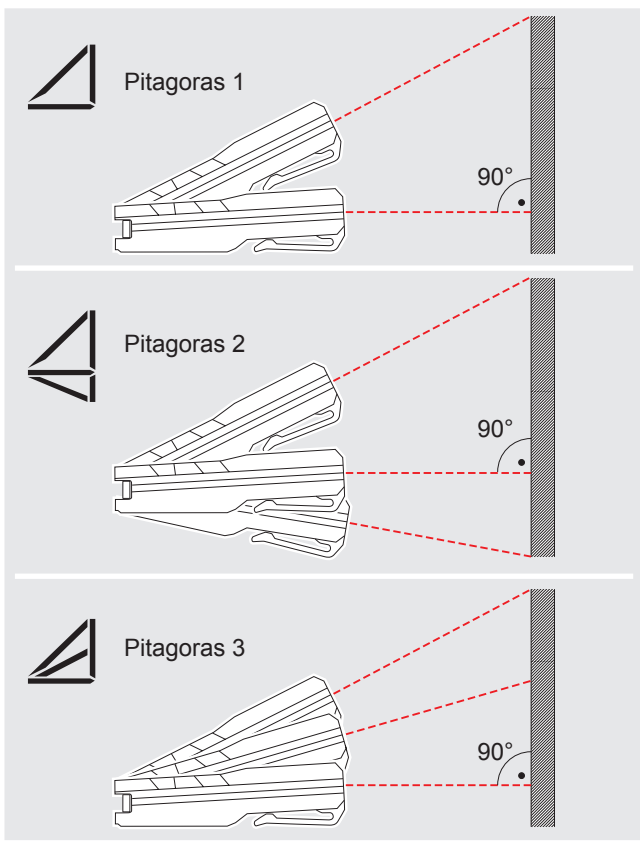
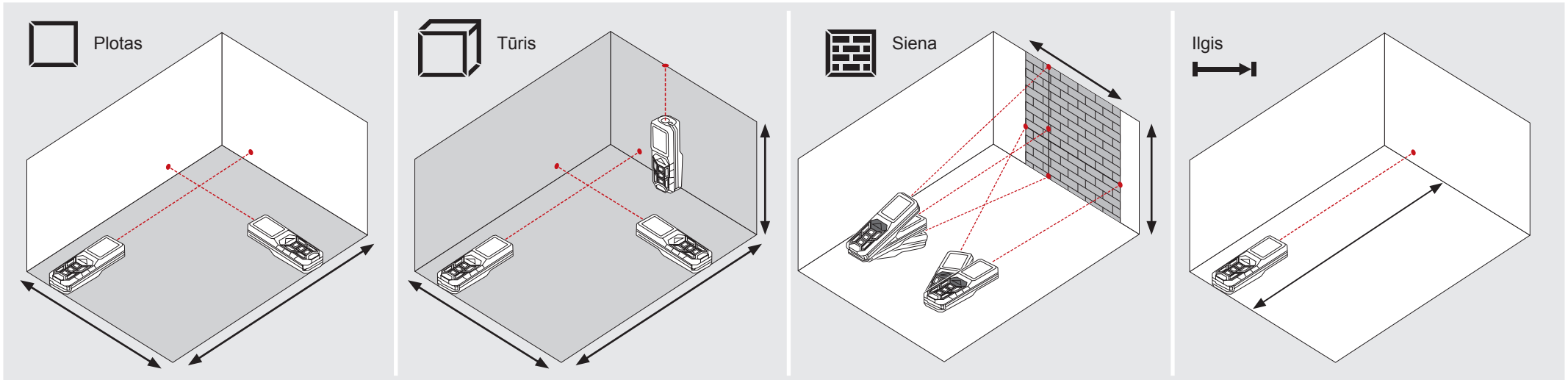

PAPRASTAS ILGIŲ MATAVIMAS

0

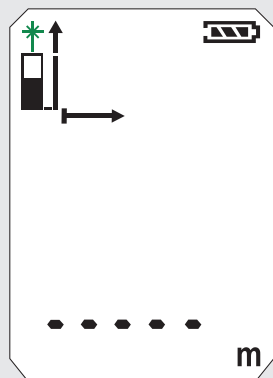

1

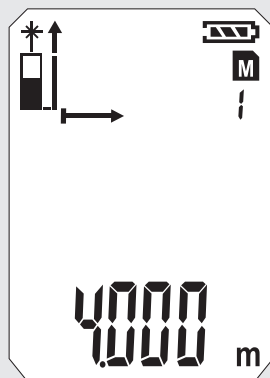
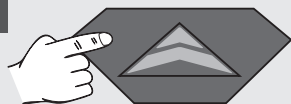

2

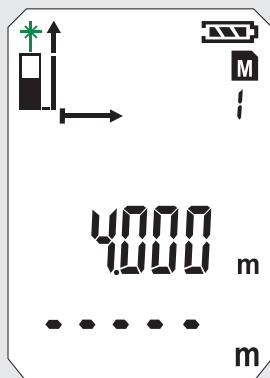
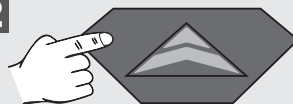

3

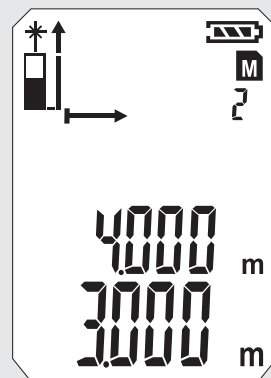
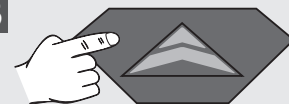

4

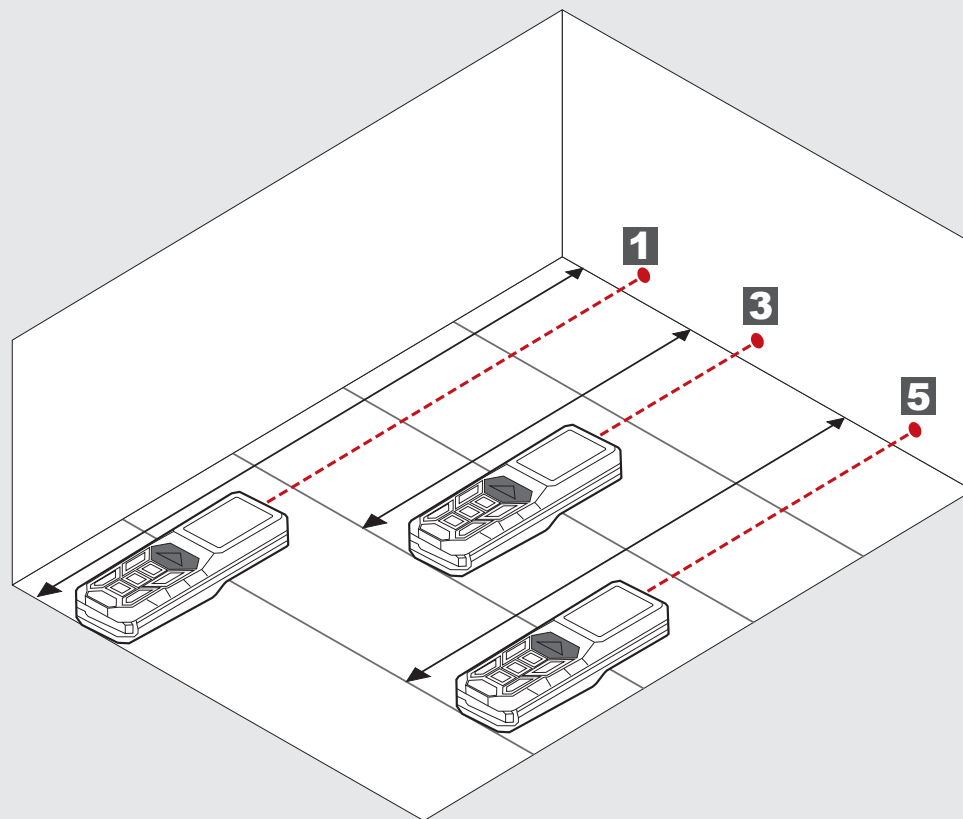
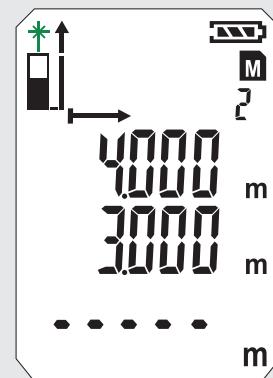
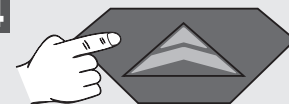

5

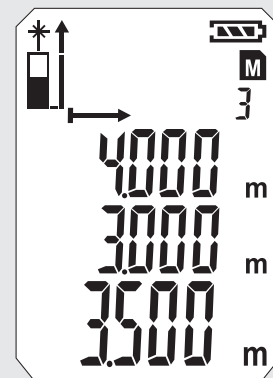
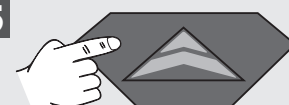

0

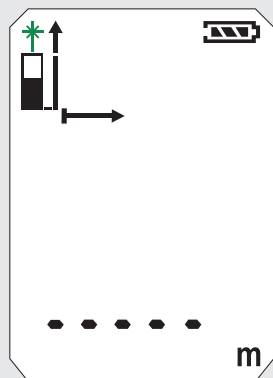

1

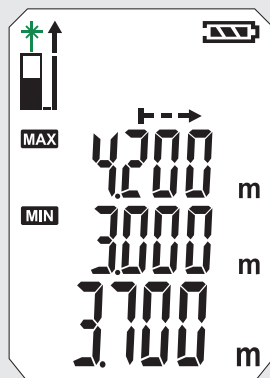
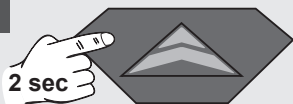

2

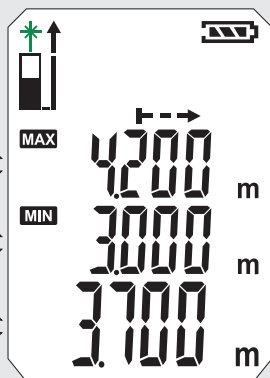

3

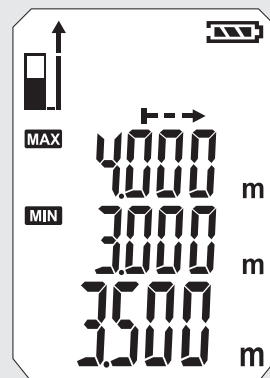
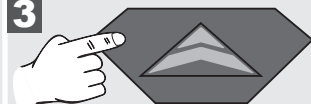

4

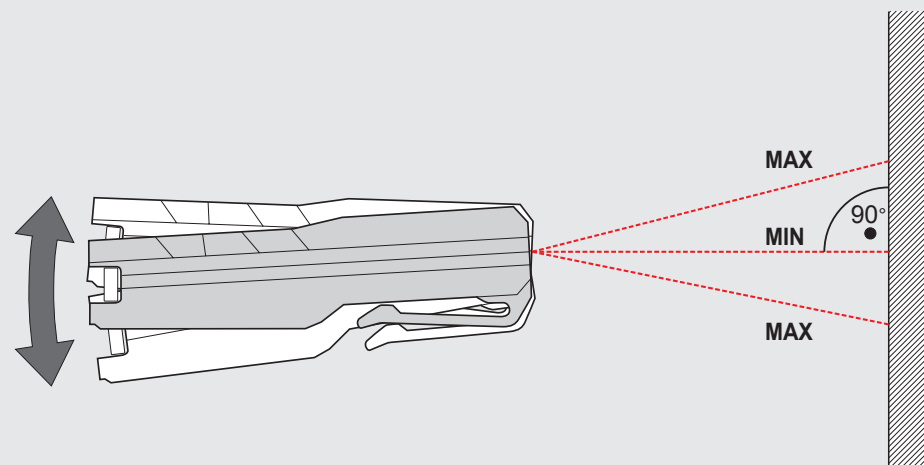
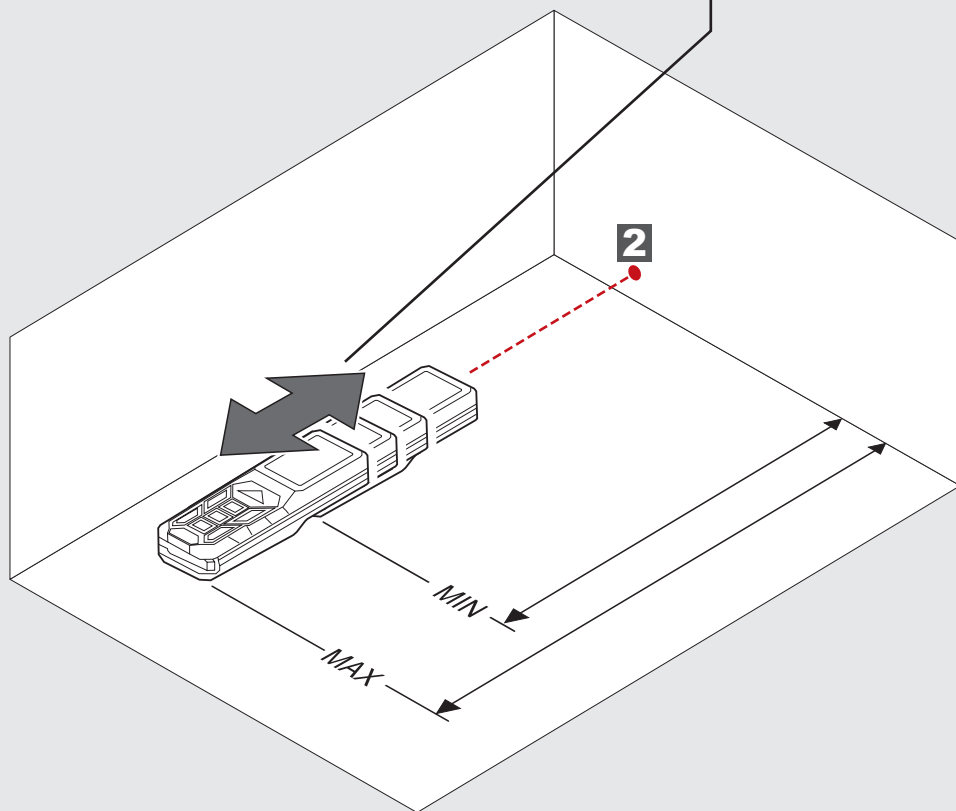
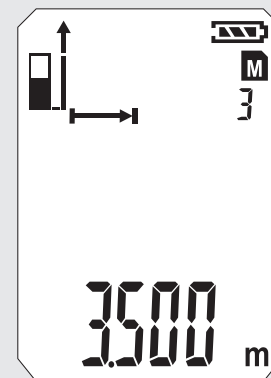
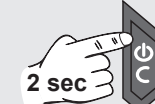

0

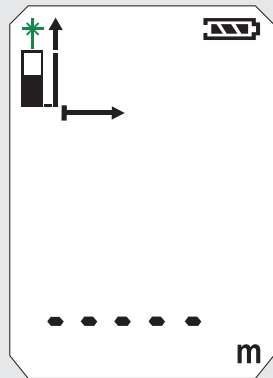

1

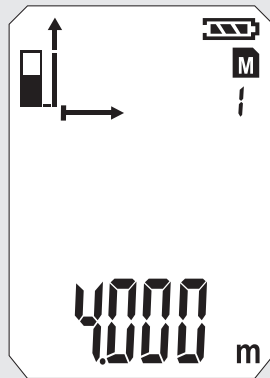
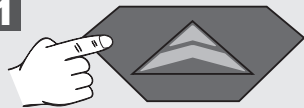

2

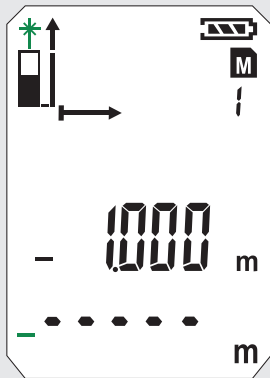

3

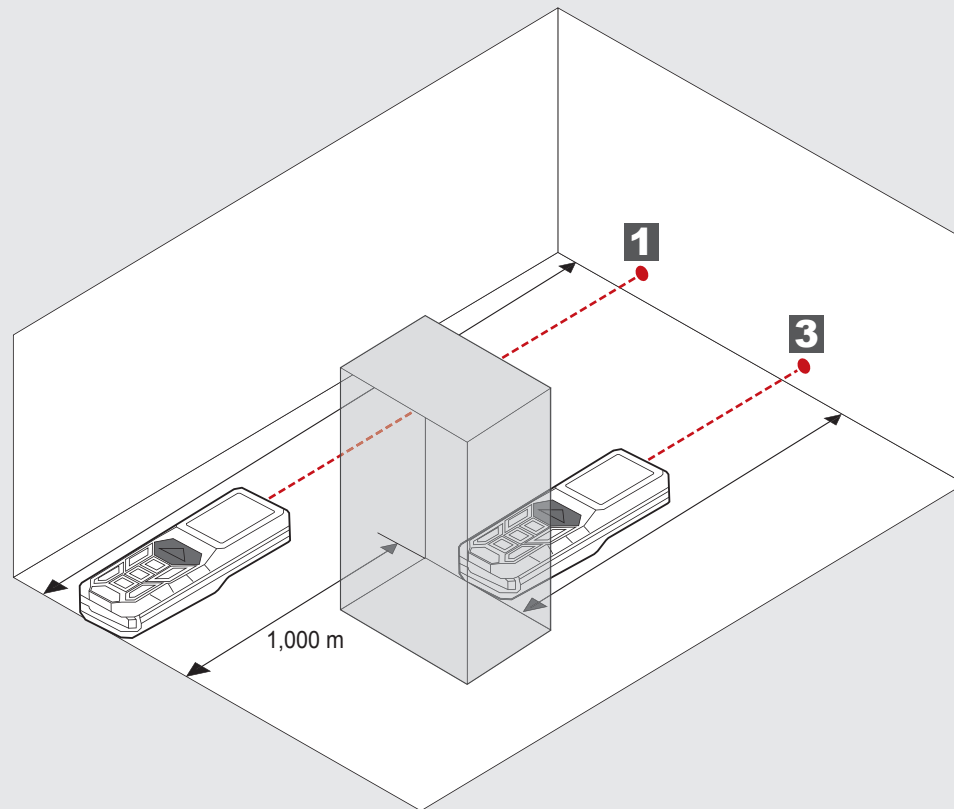
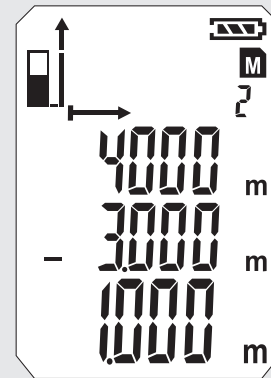
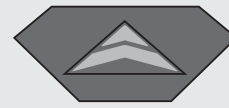

0

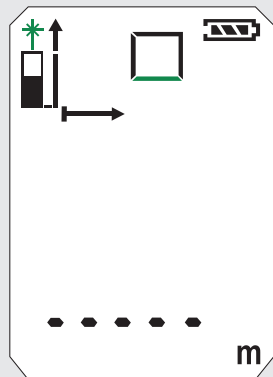

1

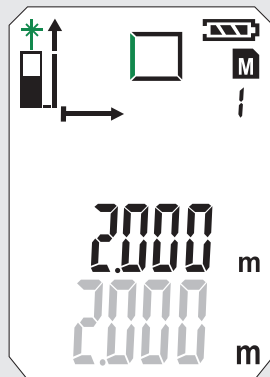
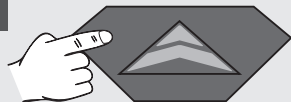

2

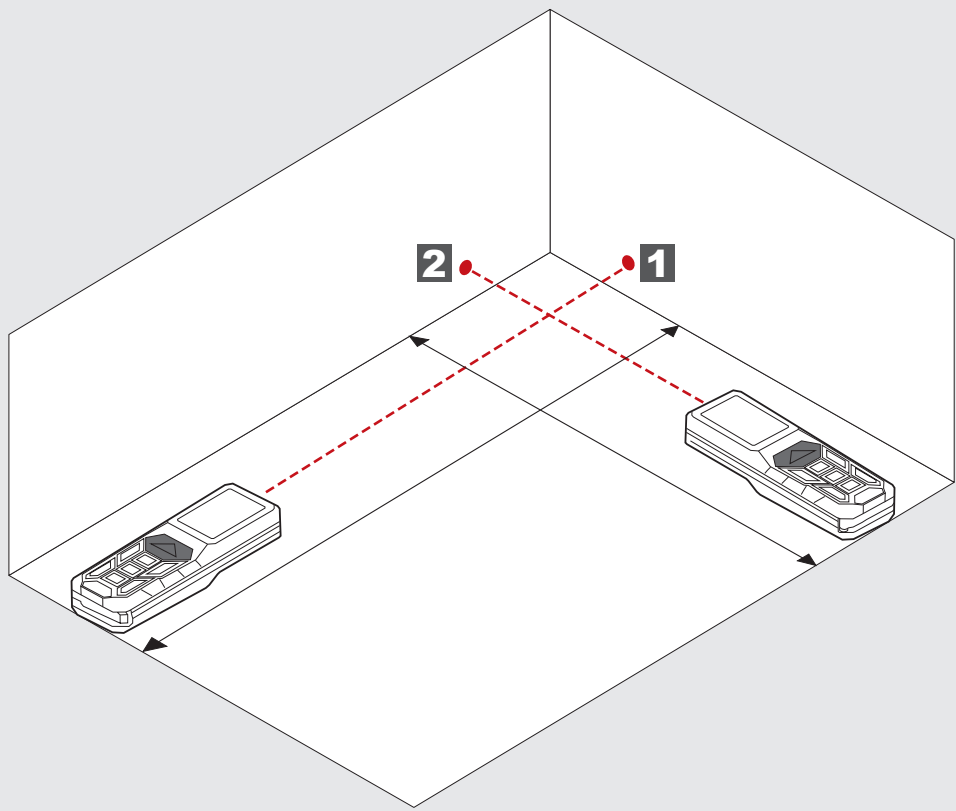
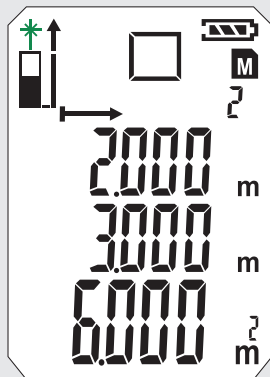
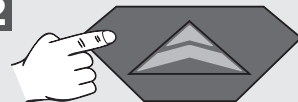

0



1

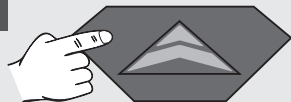

2

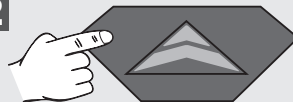

3

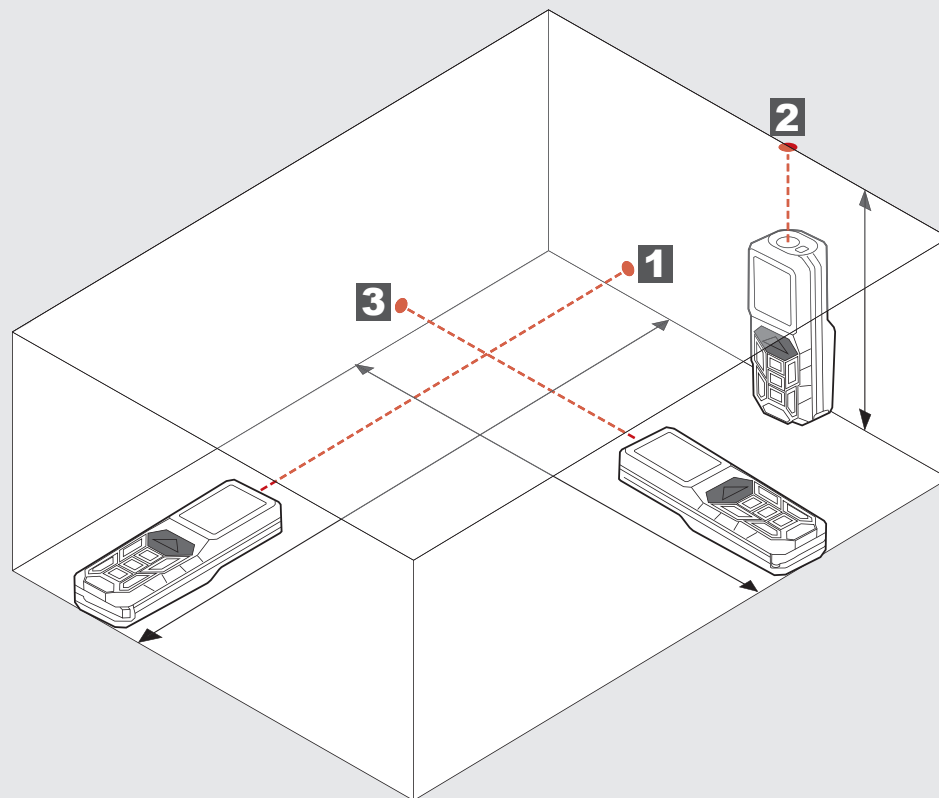
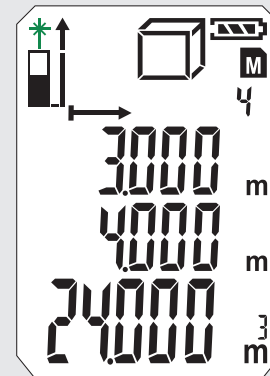
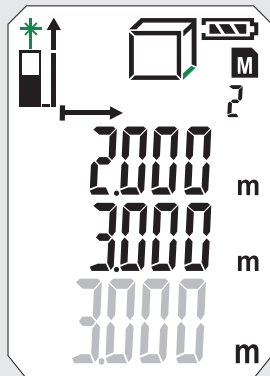
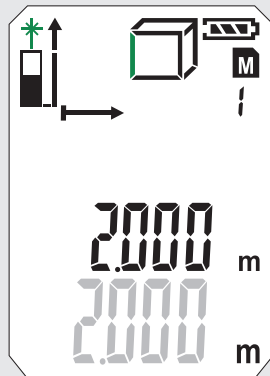
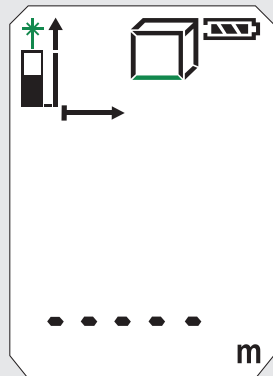
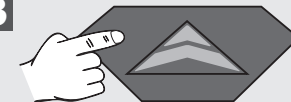

NETIESIOGINIS MATAVIMAS (PITAGORAS 1)

0



1

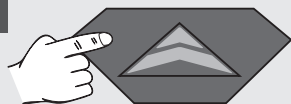

2

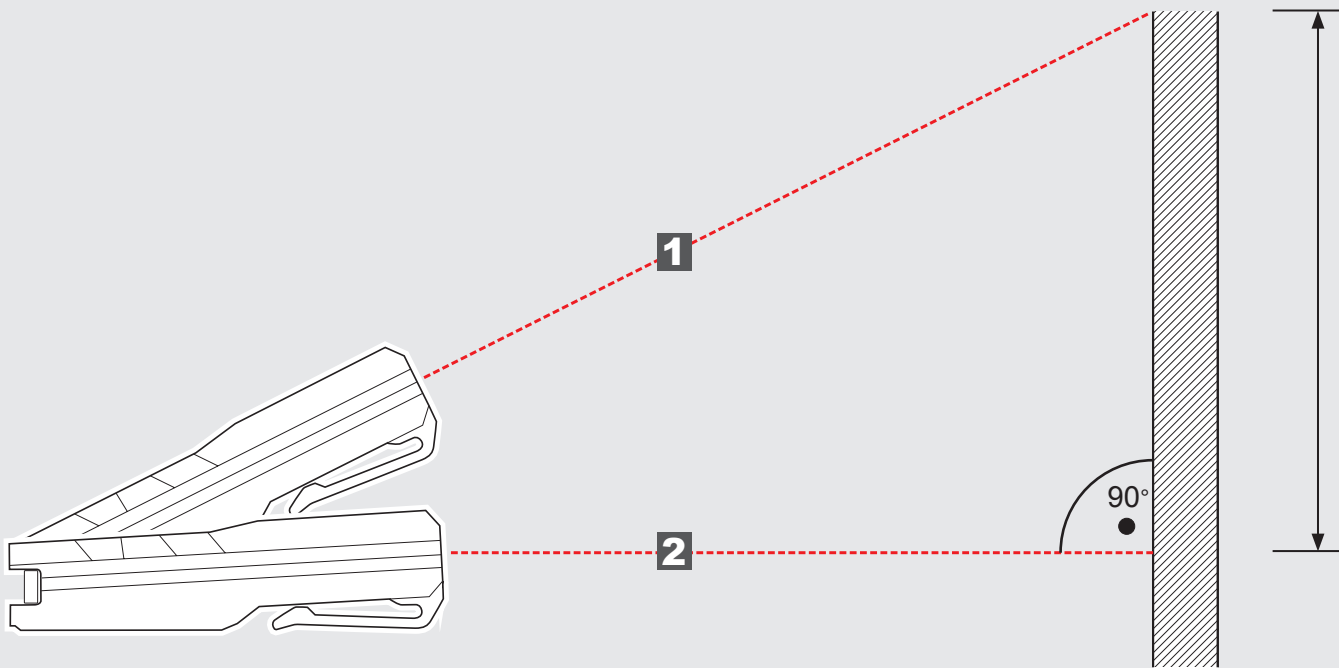
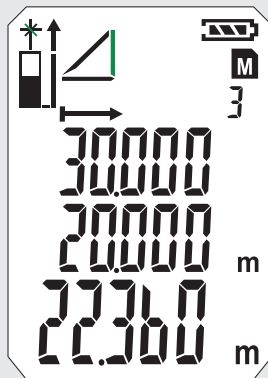
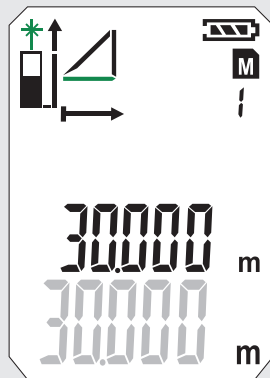
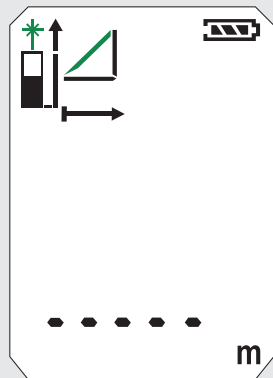

NETIESIOGINIS MATAVIMAS (PITAGORAS 2)

0



1

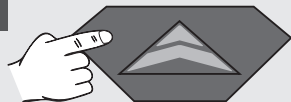

2

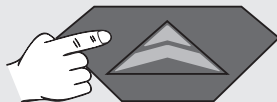

3

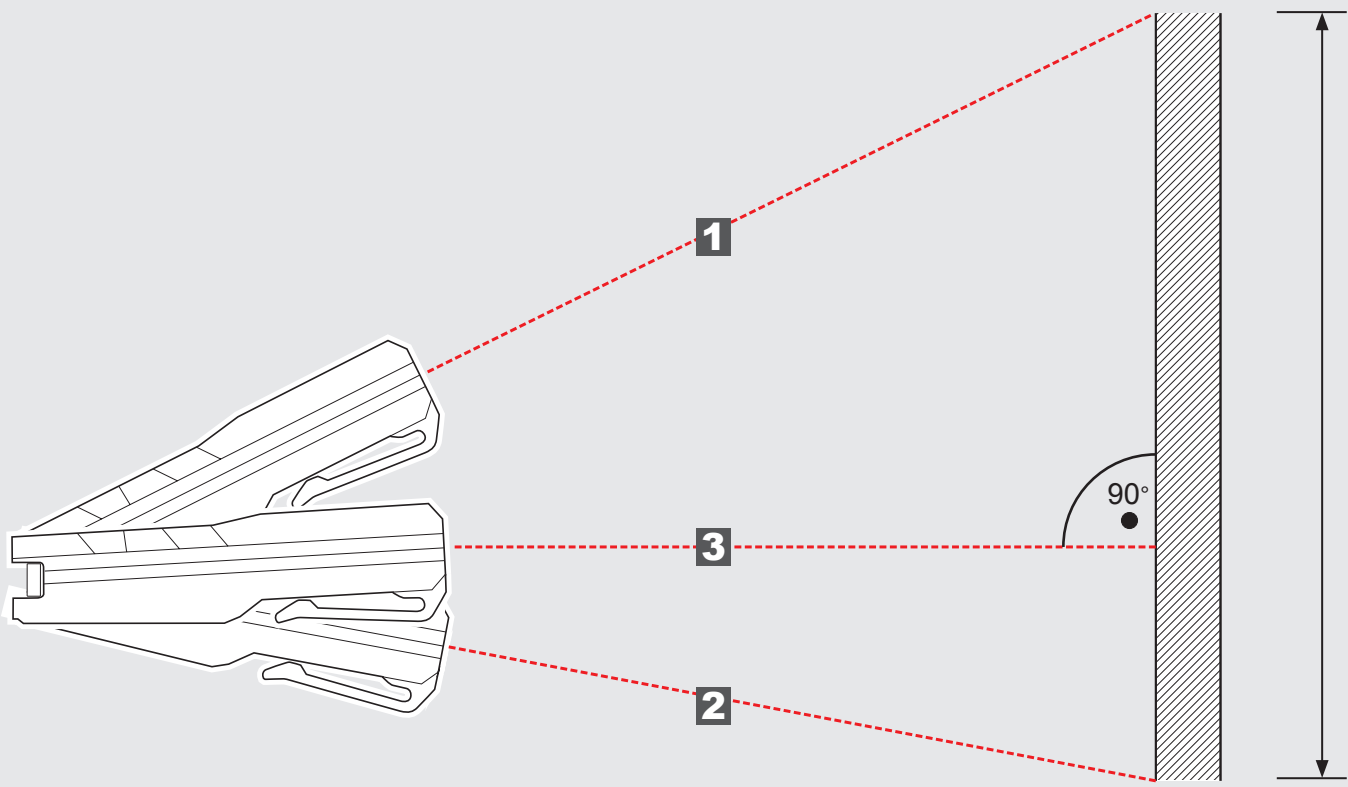
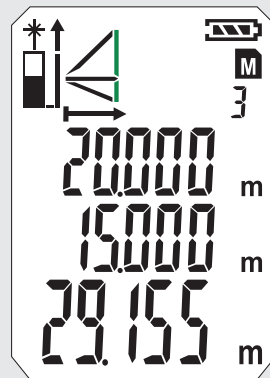
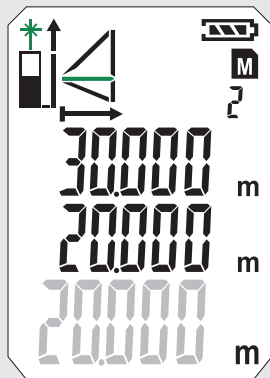
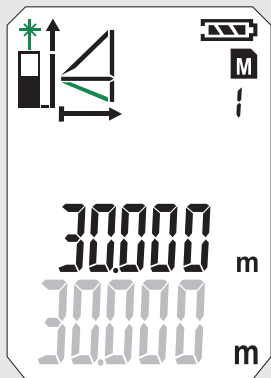
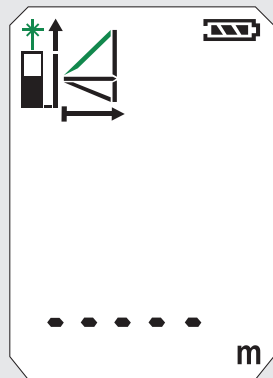

NETIESIOGINIS MATAVIMAS (PITAGORAS 3)

1



2

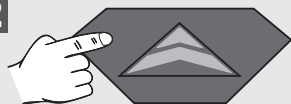

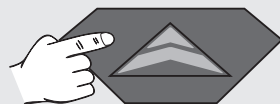

3

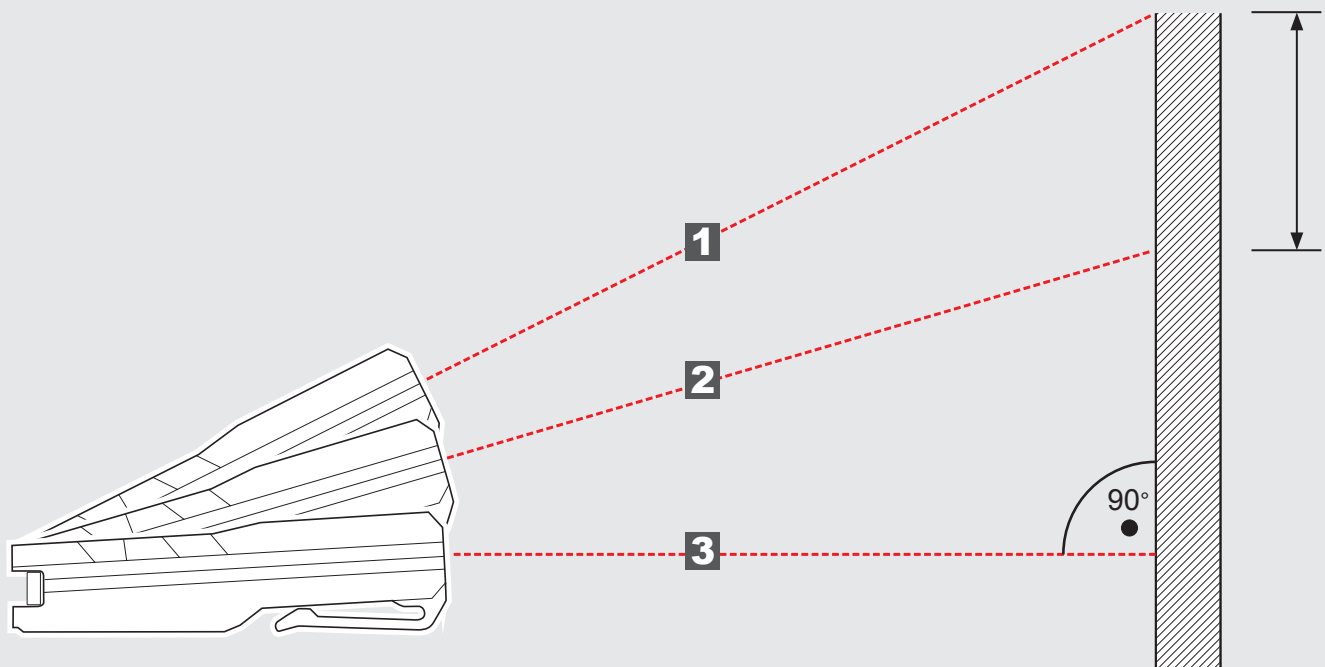
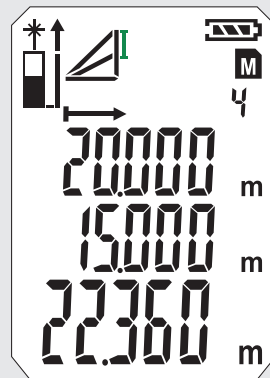
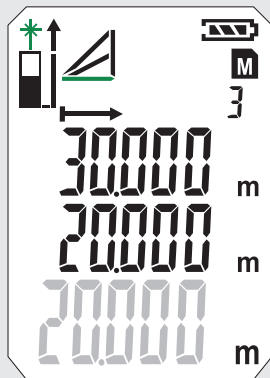
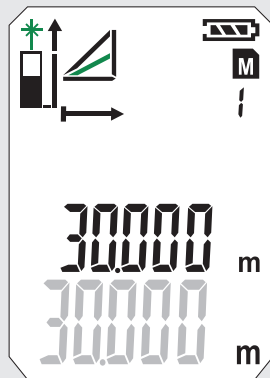
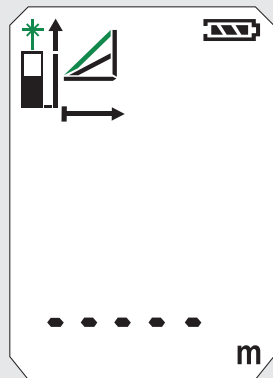

4

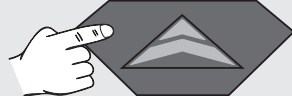
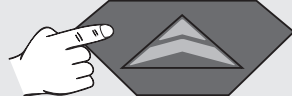
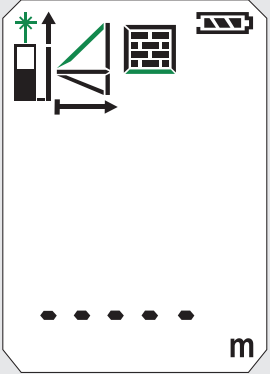
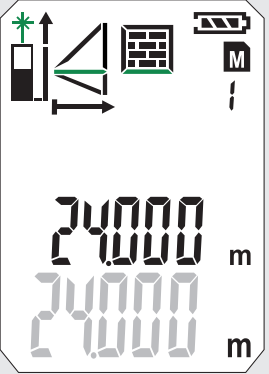
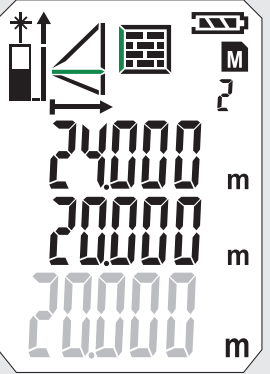
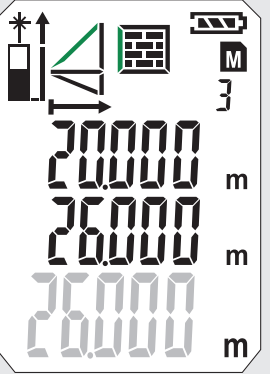
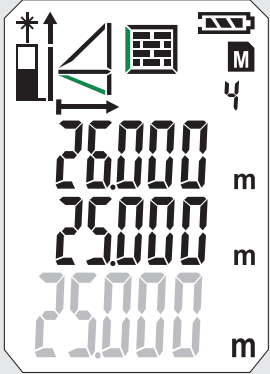

SIENELĖS PLOTO MATAVIMAS (1 SCENARIJUS)

0 	1 	2 	3 	4 
				

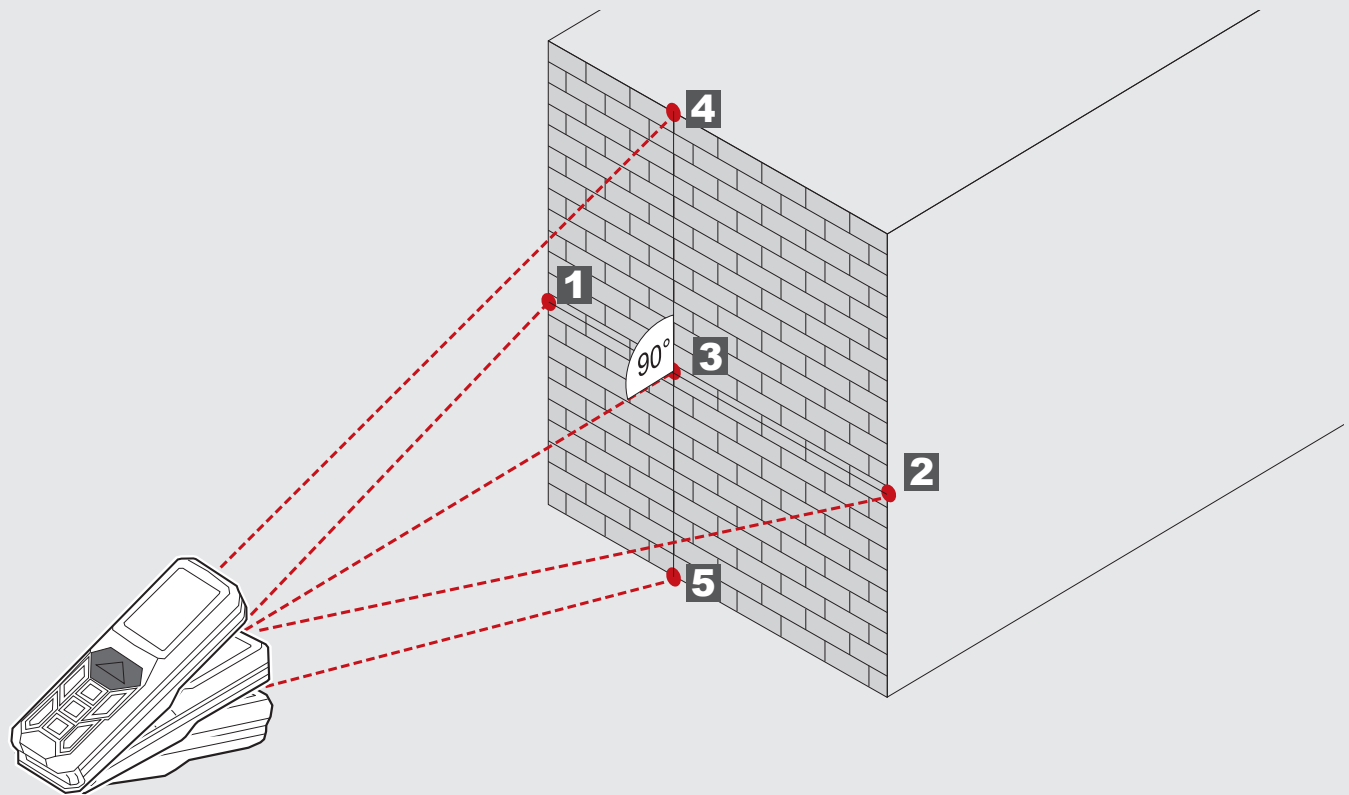

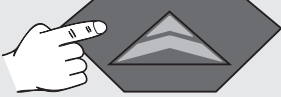
5

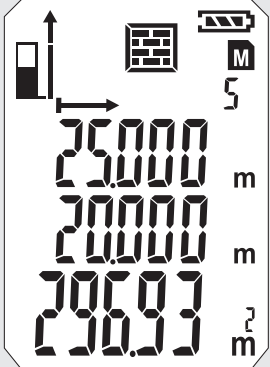

SIENELĖS PLOTO MATAVIMAS (2 SCENARIJUS)

0 	1 	2 	3 	4

5

LAIKMATIS

Laikmačiu galima matavimą užlaikyti, norint, pavyzdžiui, nustatyti konstrukcinę dalį matavimo spindulyje.

Mygtuką  paspausti

- Užsidega simbolis
- Paspaudus mygtuką  laikmatį galima nustatyti nuo 3 iki 15 sek.

Mygtuką  paspausti

- Pradedamos skaičiuoti sekundės iki matavimo
- 0 pozicijoje prasideda matavimas.

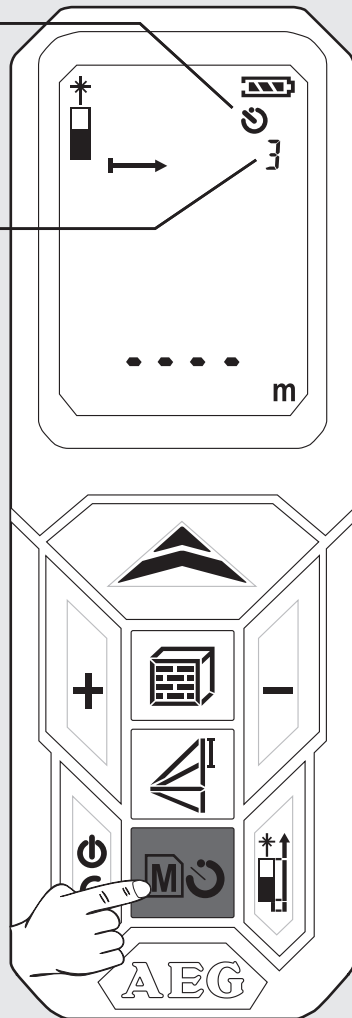

ATMINTIS

Matavimo vertė automatiškai išsaugoma atmintyje.

Išsaugotas vertes galima mygtuku  atšaukti.

Mygtuką  2 sek. nuspauskite

- Užsidega simbolis ir atminties laukas.
- Rodomi susiję matavimo dydžiai.
- Pagrindinėje eilutėje rodoma išsaugota vertė.
- Judėkite +/- "Tasten" mygtukais

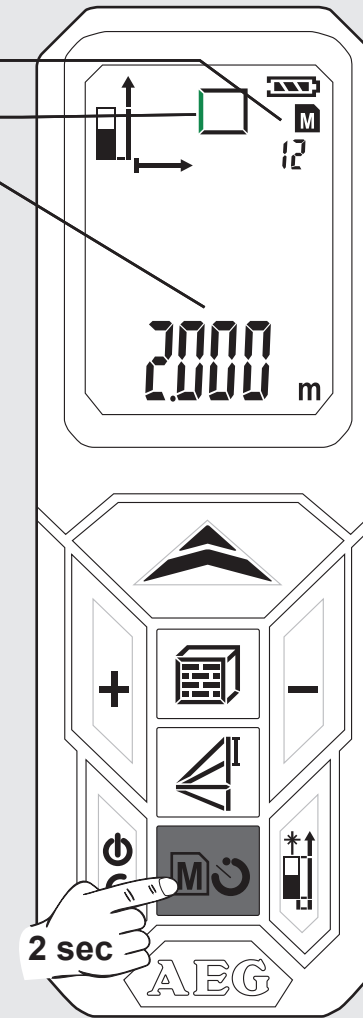



SU PAGRINDINĖS FUNKCIJOS PLOTO MATAVIMO PAVYZDŽIU (1)

1 išjungti

Mygtuką  paspausti.
⚠ Dėmesio! Lazerinis spindulys!
 Nenukreipkite į žmogų!

2 pasirinkti matavimo lygį

Standartinis nustatymas įjungus:
 užpakalyje
 1x paspausti -> kampinis kaištis
 2x paspausti -> priekyje
 3x paspausti -> užpakalyje

3 funkcijos pasirinkimas

Įjungus, prietaisas visada
 nustatytas matuoti ilgius.
 1x paspausti - plotų matavimas

4 ilgio matavimas

Išlygiuokite prietaisą ir
 mygtuką  paspauskite

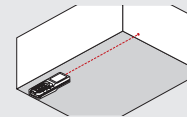

5 pločio matavimas

Išlygiuokite prietaisą
 ir mygtuką  paspauskite

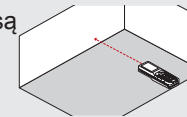

Mirksi lazerio simbolis
 (mirksi žalia spalva).

Šviečia simbolis

- Užsidega simbolis
 - Mirksi matavimo dydis
 (mirksi žalia spalva)

- Pagrindinėje eilutėje užsidega
 matavimo vertė.
 - Matavimo vertė po 1 sek. pakyla į
 aukštesnę eilutę.
 Matavimo vertė atmintyje
 išsaugoma su eiliškuoju numeriu.
 Mirksi antras matavimo dydis.
 Prietaisas tinkamas matuoti antrą
 vertę.

- Pagrindinėje eilutėje trumpai
 užsidega matavimo vertė.
 - Matavimo vertė po 1 sek. pakyla į
 aukštesnę eilutę.
 Matavimo vertė atmintyje
 išsaugoma su eiliškuoju numeriu.
 - Rezultatas rodomas pagrindinėje
 eilutėje, o atmintyje išsaugomas
 su eiliškuoju numeriu.

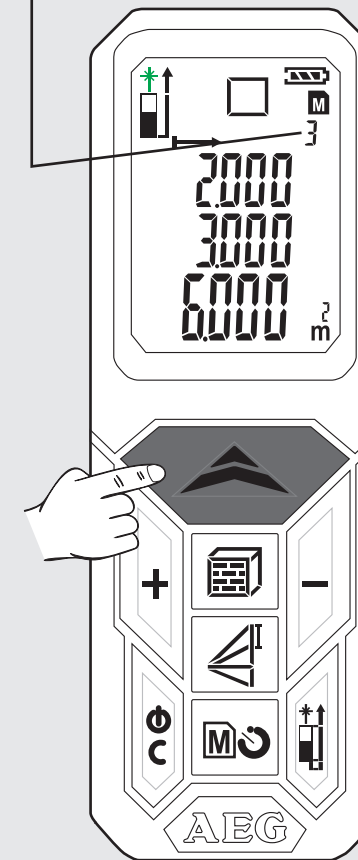
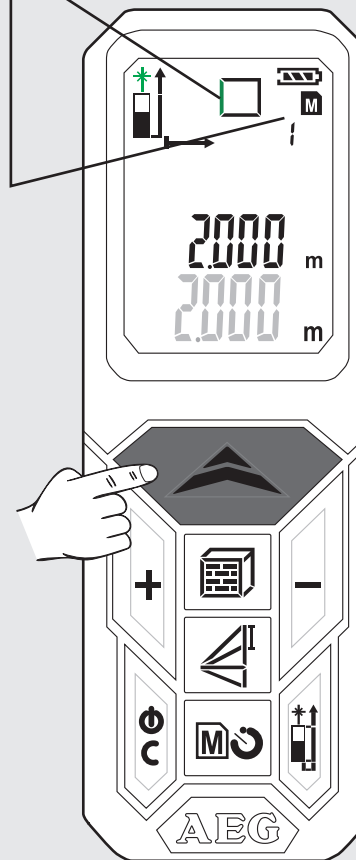
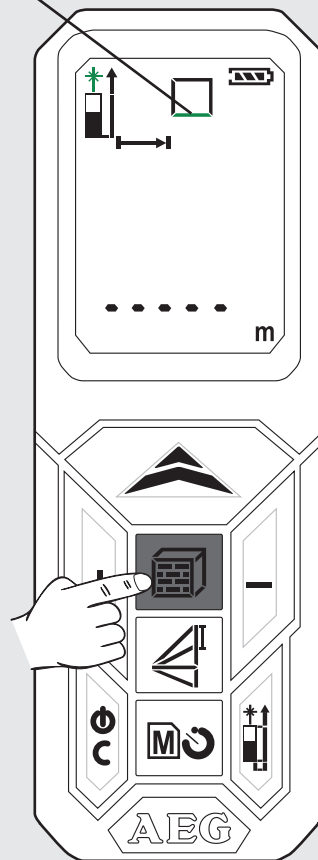
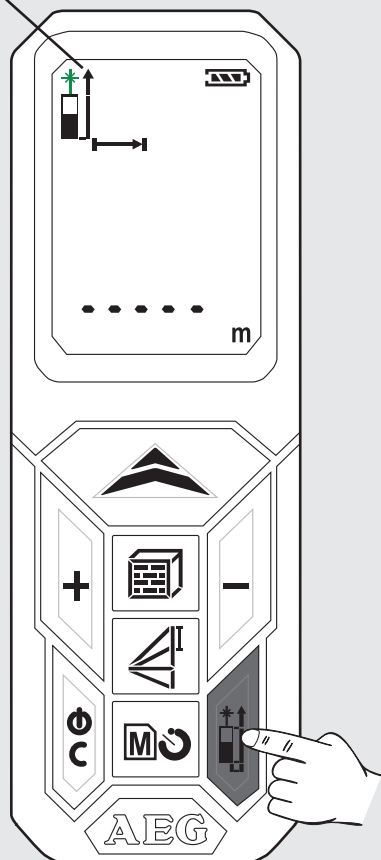
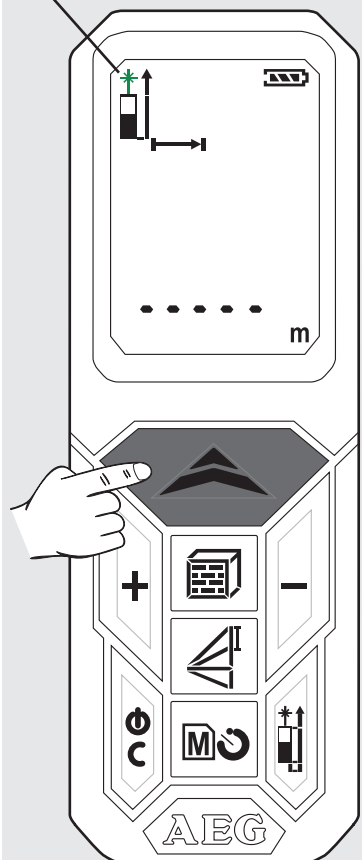

SU PAGRINDINĖS FUNKCIJOS PLOTO MATAVIMO PAVYZDŽIU (2)

6 išsaugotų verčių atšaukimas

Mygtuką  2 sek. paspauskite.
Paspauskite mygtuką + arba -

7 išeiti iš atminties

Mygtuką  paspausti

8 išjungti

Mygtuką  2 sek. paspausti
(Iš atminties prieš tai išeikite).

- Pagrindinėje eilutėje rodomos išsaugotos vertės.

- Susijęs simbolis rodomas, o matavimo vertė mirksi (mirksi žalia spalva).

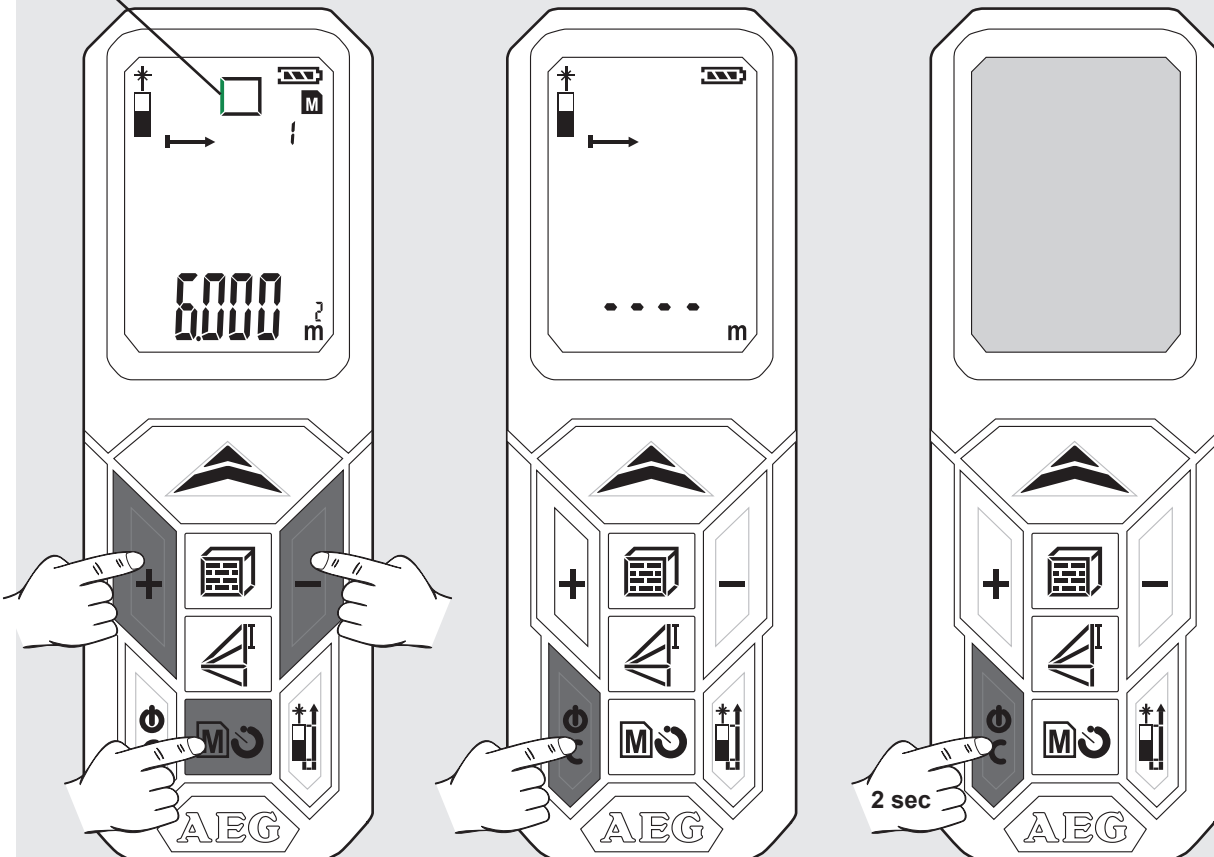

- Prietaisas išsijungia.

- Jeigu 3 minutes nepaspaudžiamas joks mygtukas, prietaisas automatiškai išsijungia.



Olulised ohutusjuhised	1
Tehnilised andmed.....	2
Kasutamine vastavalt otstarbele.....	2
Veakoodide tabel	2
Ülevaade	3
Patarei vahetamine.....	4
Nurgapliiats.....	4
Rihmahoidik.....	4
Funktsiooniklahv, Pythagoras, mõõtmistasand	5
Lihntne pikkuse mõõtmine.....	6
Pidev mõõtmine / miinimum-maksimum-mõõtmine.....	7
Lahutamise- / liitmismõõtmine	8
Pindala mõõtmine.....	9
Ruumala mõõtmine	10
Kaudne mõõtmine (Pythagoras 1).....	11
Kaudne mõõtmine (Pythagoras 2).....	12
Kaudne mõõtmine (Pythagoras 3).....	13
Seina pindala mõõtmine (stsenaarium 1).....	14
Seina pindala mõõtmine (stsenaarium 2).....	15
Taimer.....	16
Mälu.....	16
Põhiline talitlusviisi pindala mõõtmise (1) näitel	17
Põhiline talitlusviisi pindala mõõtmise (2) näitel	18

OLULISED OHUTUSJUHISED

  Ärge kasutage toodet enne, kui olete lugenud kaasasoleval CD'l olevaid Ohutusjuhiseid ja Kasutusjuhendit.

Laseri klassifikatsioon

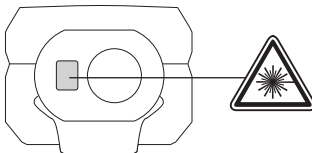

HOIATUS:
Tegemist on **2. klassi** lasertootega, mis vastab dokumendile IEC 60825-1:2007.



Kirjed

Enne eksploatatsiooni võtmist tuleb ingliskeelsele tekstile firmalauale peale liimida vastav kleebis Teie emakeeles.

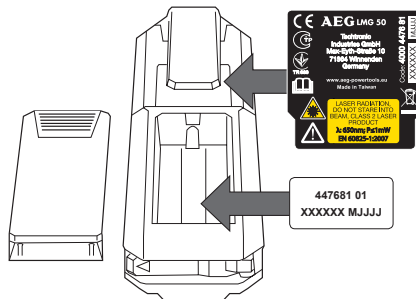

Hoiatus:

Vältige vahetut silmsidet. Laserkiir võib silmadele kiirguskahjustusi tekitada ja põhjustab lühiajalist pimestamist. Ärge vaadake laserkiirt ega suunake seda asjatult teiste isikute suunas.

Ärge pimestage teisi inimesi.

Hoiatus:

Ärge käituge laserseadet laste läheduses ega lubage lastel laserseadet kasutada.

Tähelepanu! Peegeldav pind võib laserkiirt operaatori või teiste inimeste suunas tagasi peegeldada.

Hoidke jäsemed liikuvatest osadest ohutus kauguses.

Teostage korrapäraselt testmõõtmisi. Seda eriti enne olulisi mõõtmistoid, nende ajal ja järel.

Olge tähelepanelik mõõtmisvigade suhtes, kui toode on defektne või see on maha kukkunud või seda on valesti kasutatud või muudetud.

Tähelepanu! Tutvuge aiatoõriista käsitsuselementide ja nõuetekohase kasutamisega.

Lasermõõteseadmel on piiratud kasutusvaldkond. (vt lõiku "Tehnilised andmed"). Katsed väljaspool maksimaalset ja minimaalset piirkonda mõõtmisi läbi viia, põhjustavad ebatäpsusi. Kasutamine ebasoodsates tingimustes nagu liiga kuumas, liiga külmas, väga eredas päikesevalguses, vihmas, lumes, udus või muudes nähtavust piiravates tingimustes võib ebatäpselt mõõtmisi põhjustada.

Kui lasermõõteseadet viiakse soojast ümbruskonnast külma ümbruskonda (või vastupidi), siis oodake, kuni seade on uue ümbrustemperatuuriga kohanenud.

Säilitage lasermõõteseadet alati ruumides ja kaitske seadet raputuste, vibratsioonide ning äärmuslike temperatuuride eest.

Kaitske lasermõõteseadet tolmu, märja ja kõrge õhuniiskuse eest. See võib sisemisi koostedetaile rikkuda või täpsust mõjutada.

Ärge kasutage agressiivseid puhastusvahendeid ega lahusteid. Puhastage ainult puhta, pehme lapiga.

Vältige lasermõõteseadme puhul tugevaid lööke või mahakukkumist. Seadme täpsus tuleks üle kontrollida, kui see oli maha kukkunud või muudele mehaanilistele koormustele allutatud.

Antud laserseadmel tohib nõutavaid remonditoid teostada üksnes volitatud erialapersonal.

Ärge kasutage toodet plahvatusohtlikes kohtades ega agressiivses keskkonnas.

Kasutage akude laadimiseks ainult tootja soovitatud laadijaid.

 Tühjasid patareisid ei tohi visata majapidamisjäätmete hulka. Säätke keskkonda ja viige need kogumispunktidesse, nagu on sätestatud riiklikes ja kohalikes eeskirjades. Seadet ei tohi visata majapidamisjäätmete hulka. Kõrvaldage toode kasutuselt riigis kehtivate eeskirjade järgi. Täitke vastavaid kohalikke ja riiklikke eeskirju. Pöörduge kohaliku ameti või edasimüüja poole, et utiliseerimise kohta teavet saada.



TEHNILISED ANDMED

Kaitseklass	IP54 (tolmu ja veepritsmete eest kaitstud)
Optika	14 mm
Fookuskaugus	35 mm
Mõõtevahemik max	50 meetrit (tolerants: 55m)
Mõõtevahemik min	0,05 meetrit
Absoluutne täpsus @ < 10m	± 1,5 mm (max)
Korduvtäpsus @ < 10m	± 1,5 mm (tüüpiliselt max 2σ)
Korduvtäpsus @ > 10m	tõus ± 0,25 mm / meetri kohta (tüüpiliselt max 2σ)
Mõõtmisaeg	0,5 s
Displei tüüp	LCD (22,7 mm x 31 mm)
Voolutoide	AAA 2x (Alkaline patarei)
Patarei eluiga	10000 (üksikmõõtmine)
Laseri väljundvõimsus	0,6 mW ~ 0,95 mW (klass 2, 650nm)
Laserpunkti suurus	25 x 30 mm @ 16 m (max)
Laserkiire vertikaalnurk	+1 kraad
Laserkiire horisontaalnurk	±1 kraad
Seadme automaatne väljalülitus	180 sekundit
Laseri automaatne väljalülitus	30 sekundit
Töötemperatuuri vahemik	-10°C kuni +50°C
Ladustamistemperatuuri vahemik	-25°C kuni +70°C
Kaal patareita	80 g

KASUTAMINE VASTAVALT OTSTARBELE

Lasermõõteseade sobib distantside ja kallete mõõtmiseks.

Antud seadet tohib kasutada ainult vastavalt äranäidatud otstarbele.

VEAKOODIDE TABEL

Kood	Kirjeldus	Lahendus
Err01	Väljaspool mõõtevahemikku	Viige mõõtmine läbi ettenähtud vahemikus.
Err02	Peegeldav signaal on liiga nõrk	Valige parem pealispind.
Err03	Väljaspool näiduvahemikku (max väärtus: 99 999) nt on pindala või ruumala tulemus väljaspool näiduvahemikku	Kontrollige, kas väärtused ja sammud on korrektsed.
Err04	Viga Pythagorase arvutamisel	Kontrollige, väärtused ja sammud on korrektsed.
Err05	Patarei tühi	Pange uued patareid sisse.
Err06	Väljaspool töötemperatuuri vahemikku	Viige mõõtmine läbi etteantud töötemperatuuri vahemikus.
Err07	Ümbrusvalgus liiga ere	Pimendage sihtpiirkond.

Pythagoras
Kõrgusevahe

Pindala / ruumala
Pindala kaudne mõõtmine

Mõõtmistasand

Patarei olek

Pikkuse mõõtmine

Mälu

Taimer

Miinumum / maksimum pidevaks mõõtmiseks

Pidev mõõtmine

Vaheväärtused

Liitmine / lahutamine

Koguväärtus

SISSE / MÕÕTMINE

- ▶ Sisse
- ▶ Mõõtmine
- ▶ Pidev mõõtmine (vajutage 2 sek)
Min / max funktsioon

LAHUTAMINE

- ▶ Väärtuse lahutamine
- ▶ Mälus navigeerimine

LIITMINE

- ▶ Väärtuse liitmine
- ▶ Mälus navigeerimine

PYTHAGORAS

- ▶ Pythagoras 1 (vajutage 1x)
- ▶ Pythagoras 2 (vajutage 2x)
- ▶ Pythagoras 3 (vajutage 3x)

PINDALA / RUUMALA

- ▶ Pindala (vajutage 1x)
- ▶ Ruumala (vajutage 2x)
- ▶ Pindala kaudne mõõtmine (vajutage 3x / 4x)

MÕÕTMISTASANDI VAHETAMINE

- ▶ Ees
- ▶ Taga
- ▶ Nurgapliats

SISSELÜLITAMINE

- ▶ Sisse
- ▶ Välja (vajutage 2 sek)
- ▶ Lähtestamine

MÄLU

- ▶ Taimer 3-15 sek (vajutage 1x)
- ▶ Mälu 1-20 (vajutage 1x 2 sek)
- ▶ Navigeerige mälu +/- klahvidega

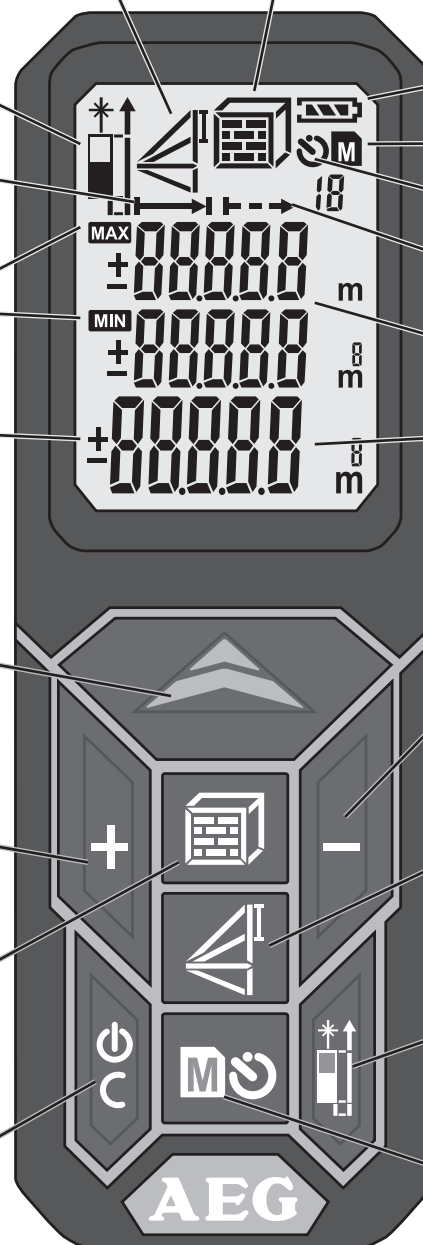

PATAREI VAHETAMINE

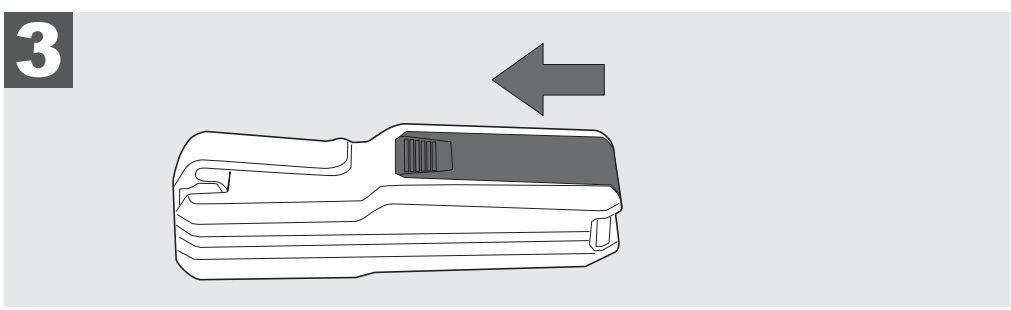
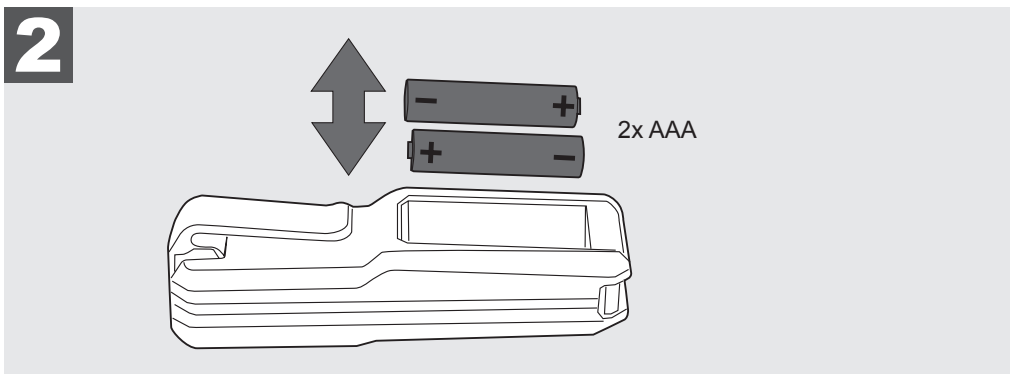
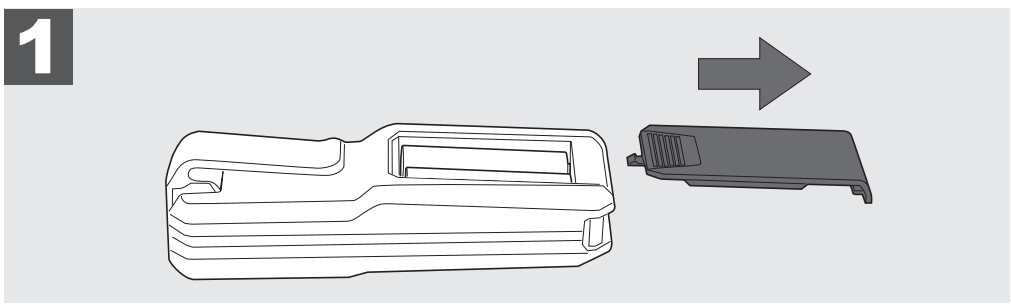
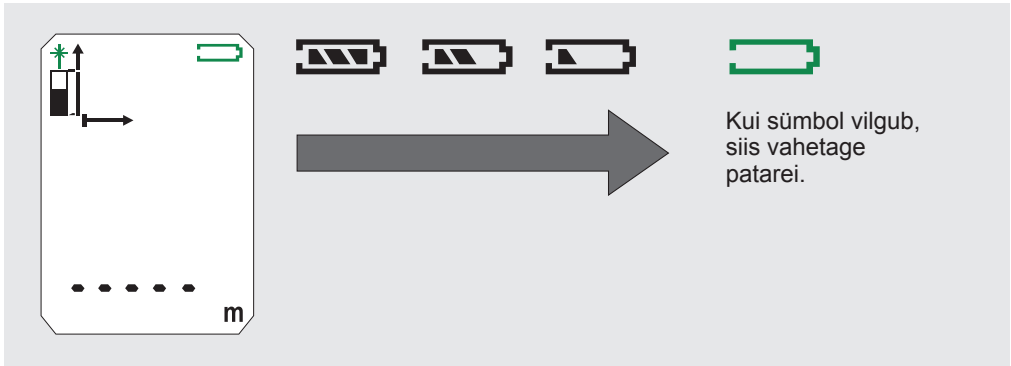

NURGAPLIATS

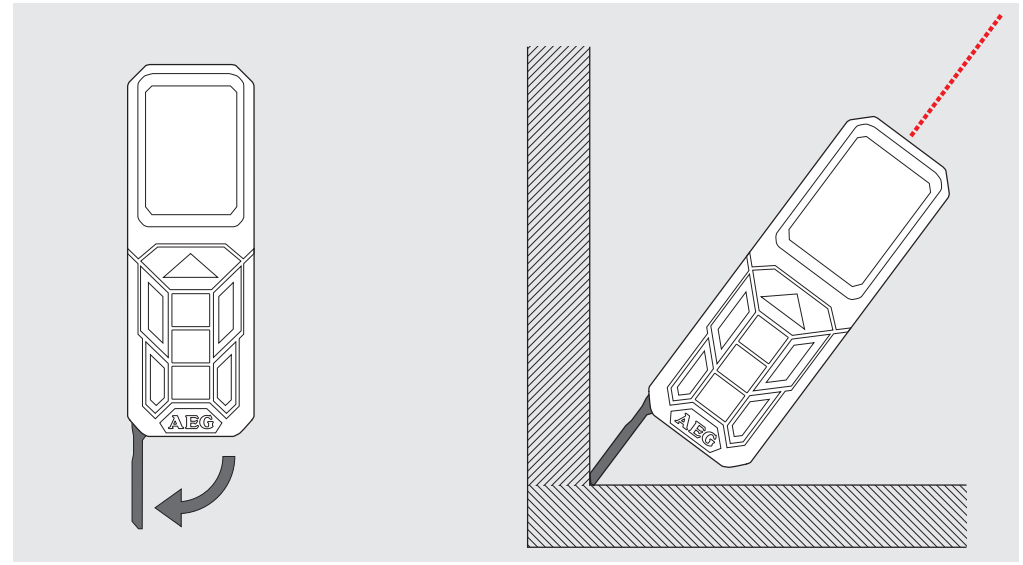

RIHMAHOIDIK

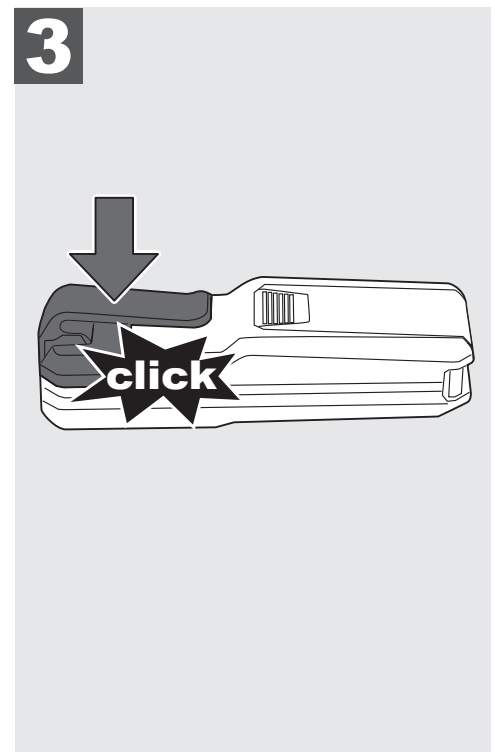
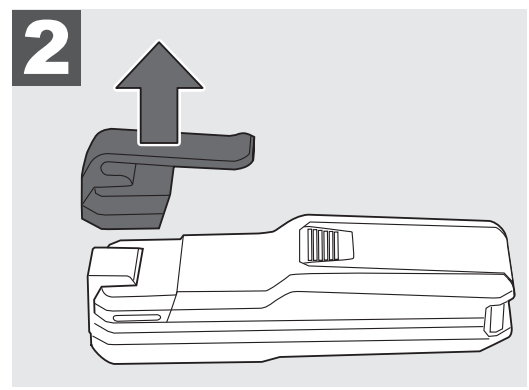
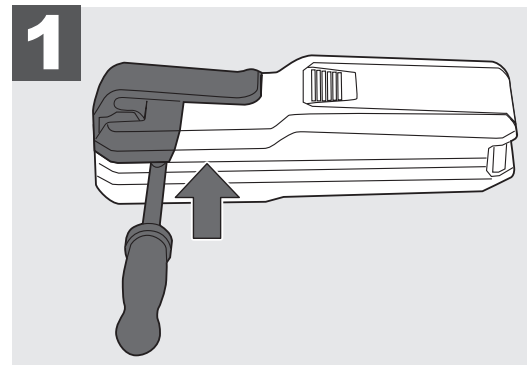

FUNKTSIOONIKLAHV, PYTHAGORAS, MÕÖTMISTASAND

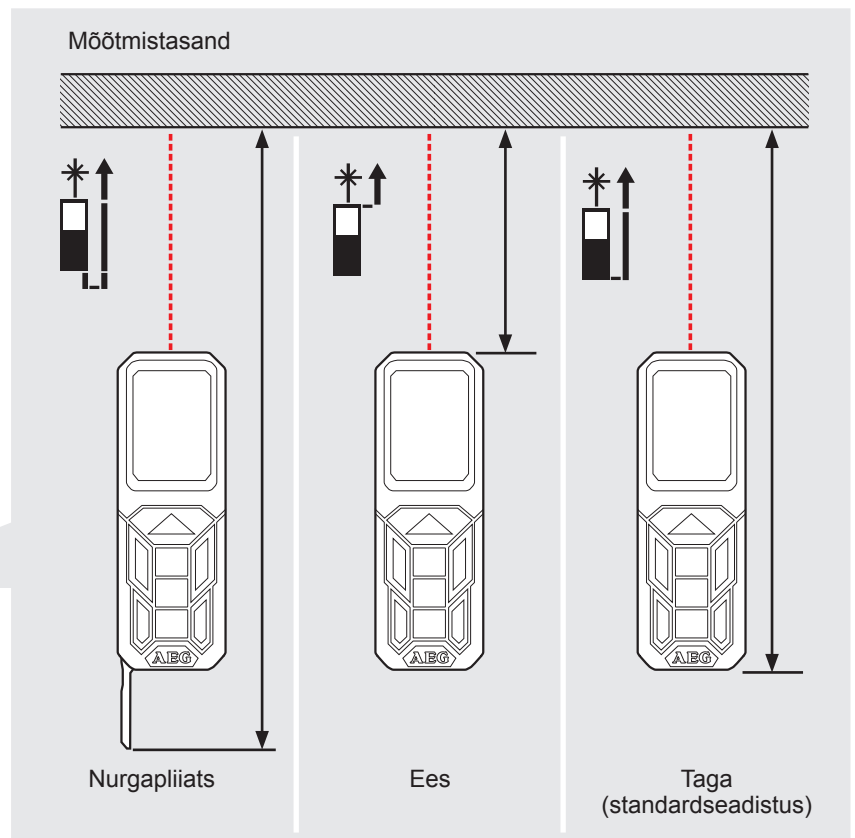
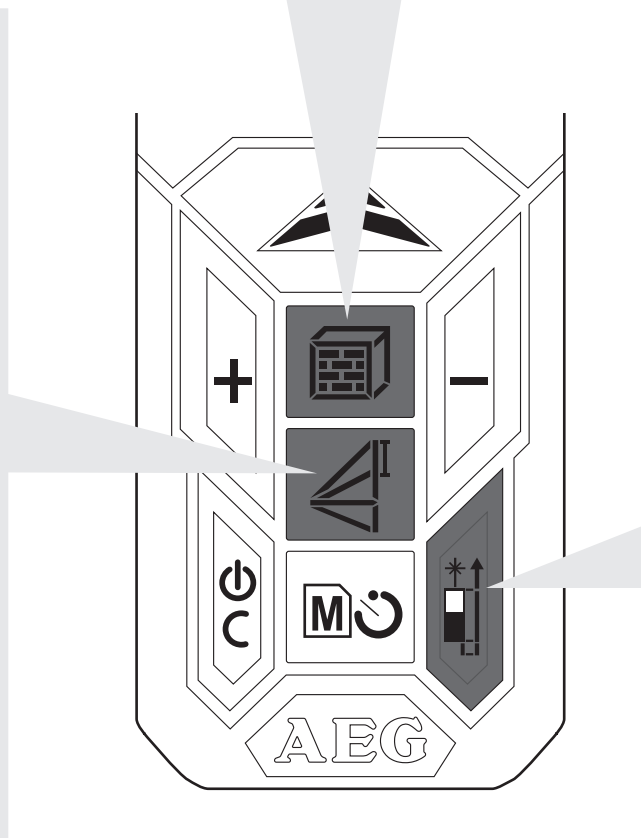
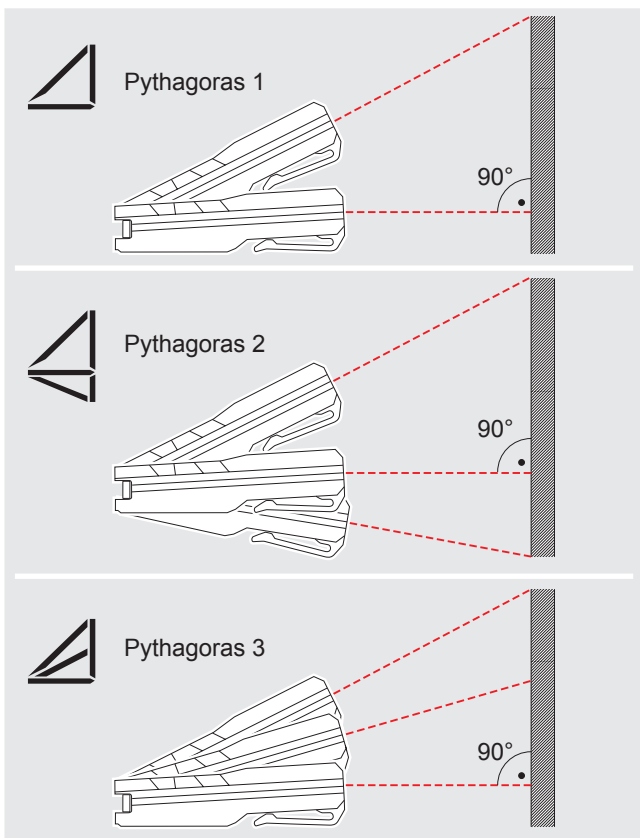
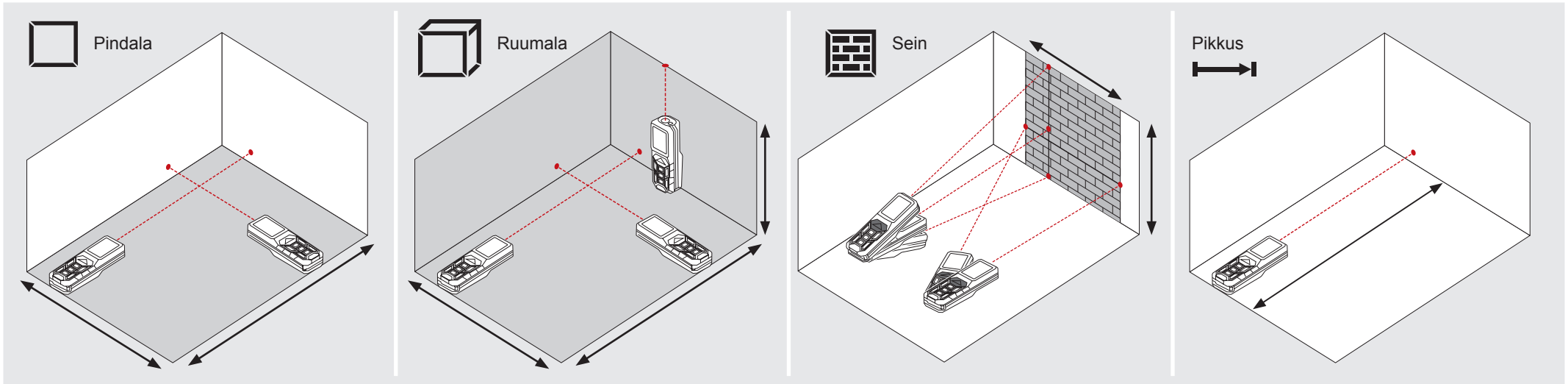

LIHTNE PIKKUSE MÕOTMINE

0

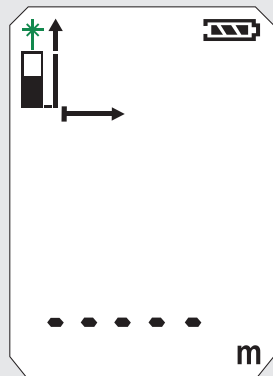

1

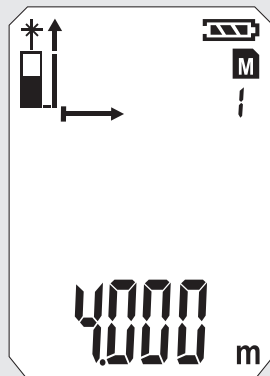
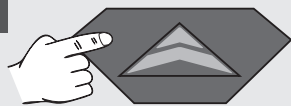

2

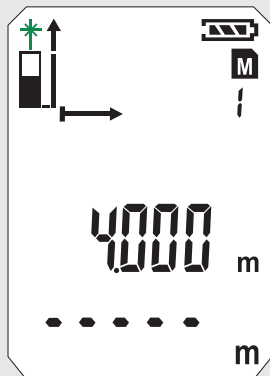
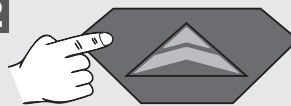

3

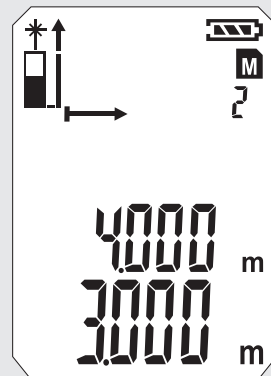
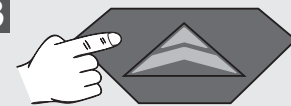

4

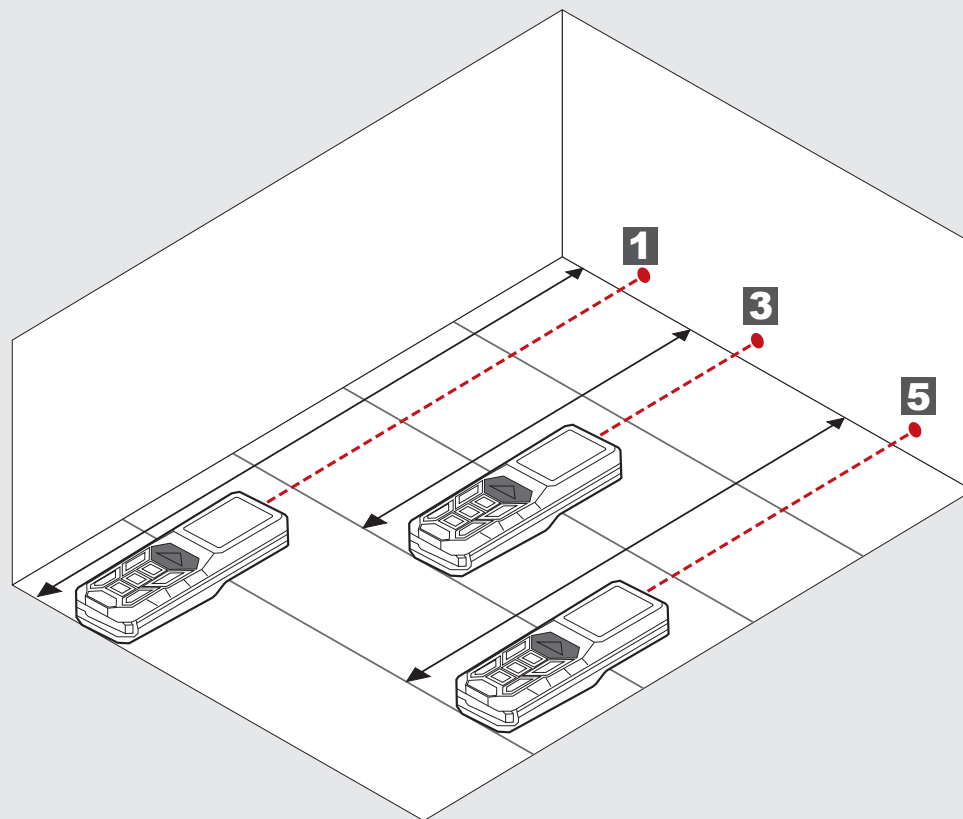
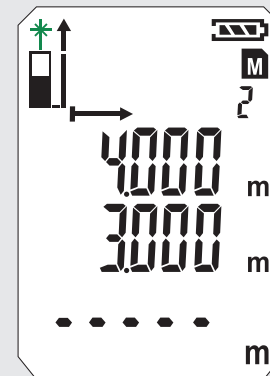
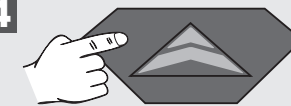

5

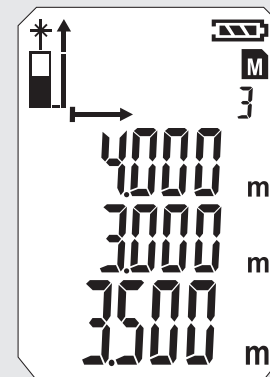
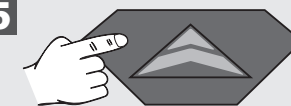

PIDEV MÕOTMINE / MIINIMUM-MAKSIMUM-MÕOTMINE

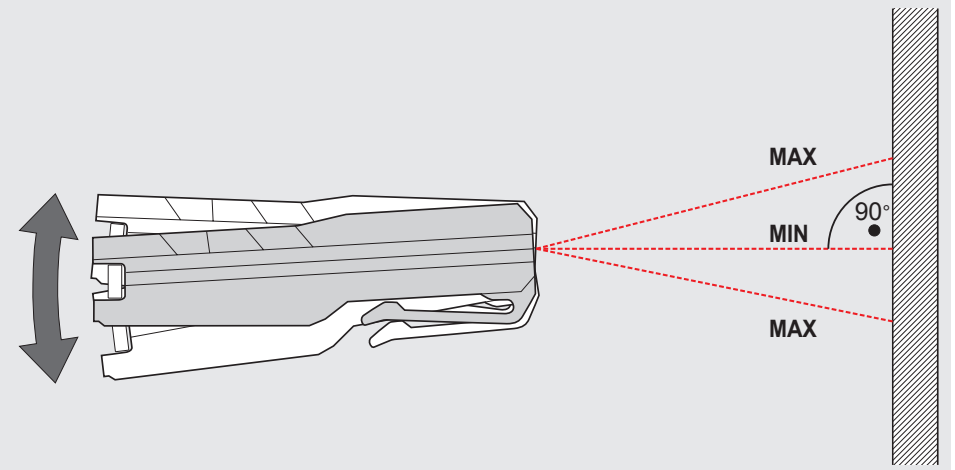
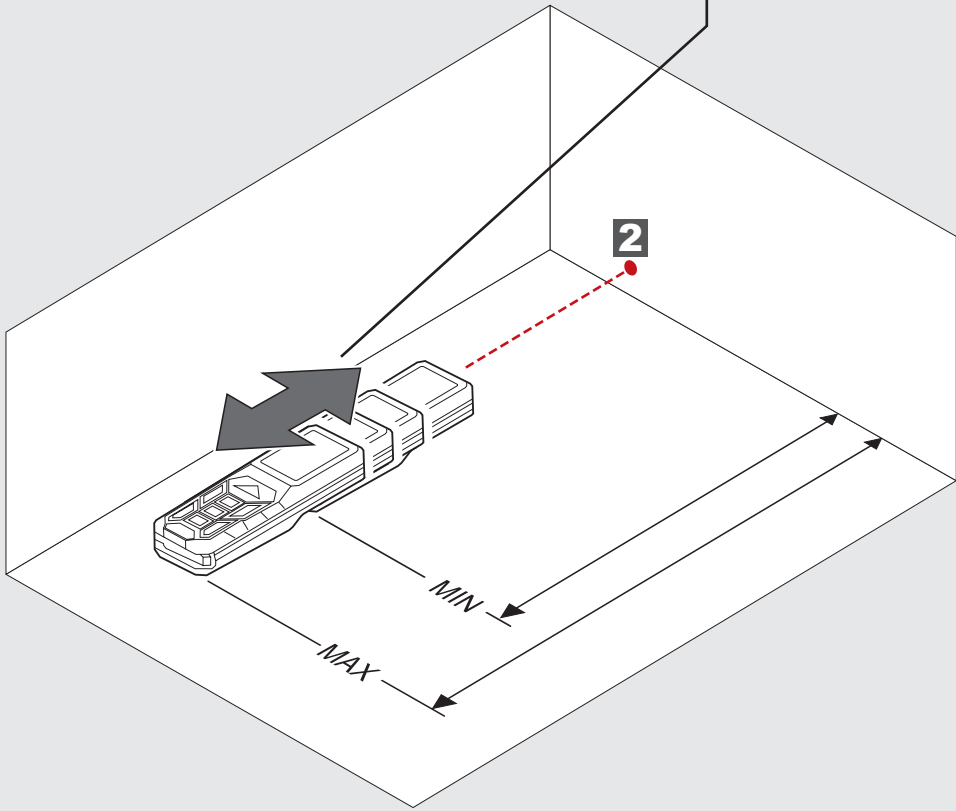
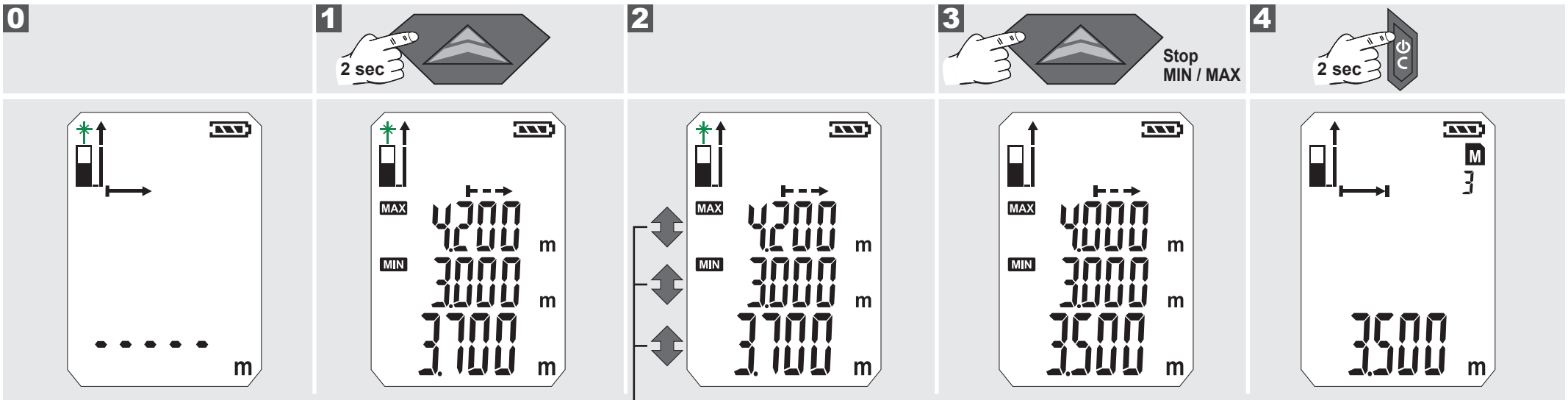

0

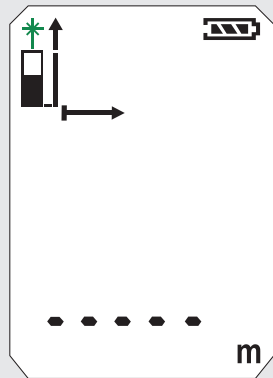

1

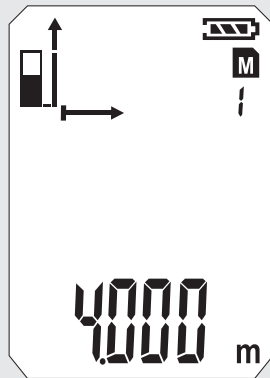
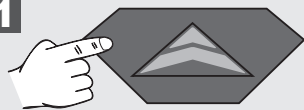

2

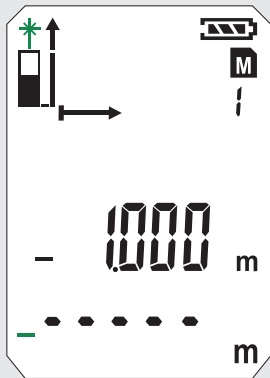

3

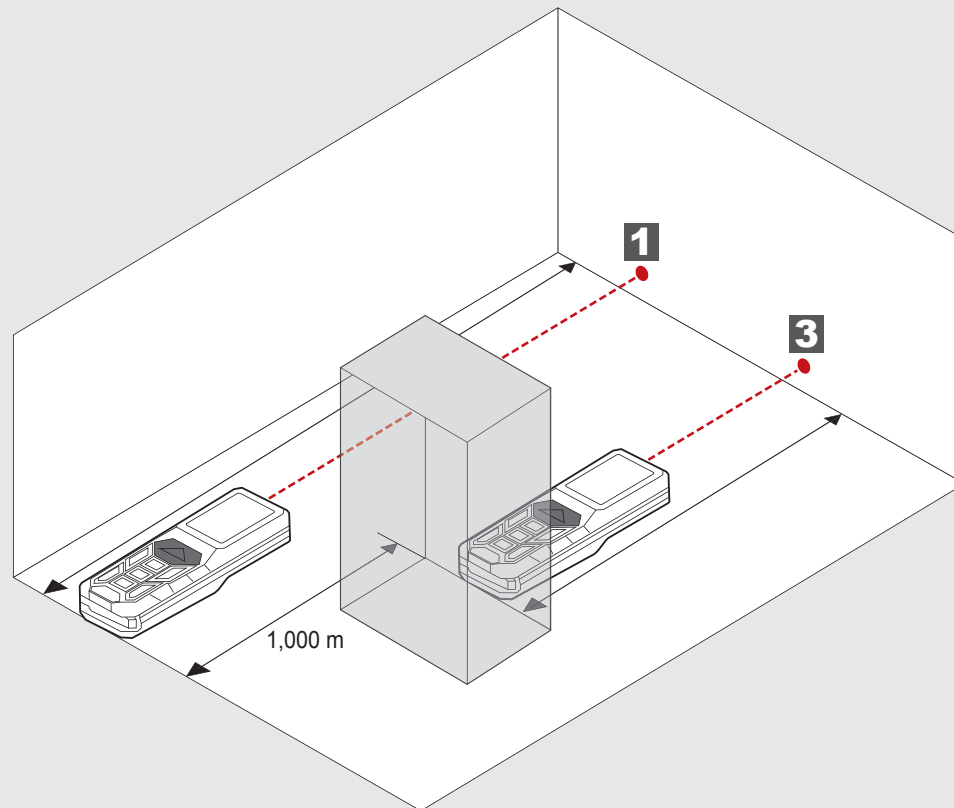
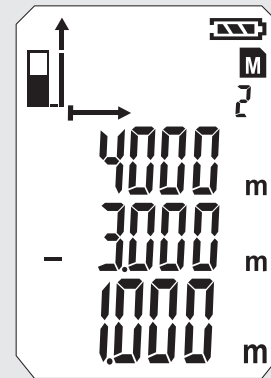
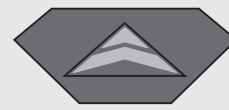

0



1

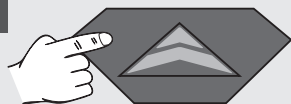

2

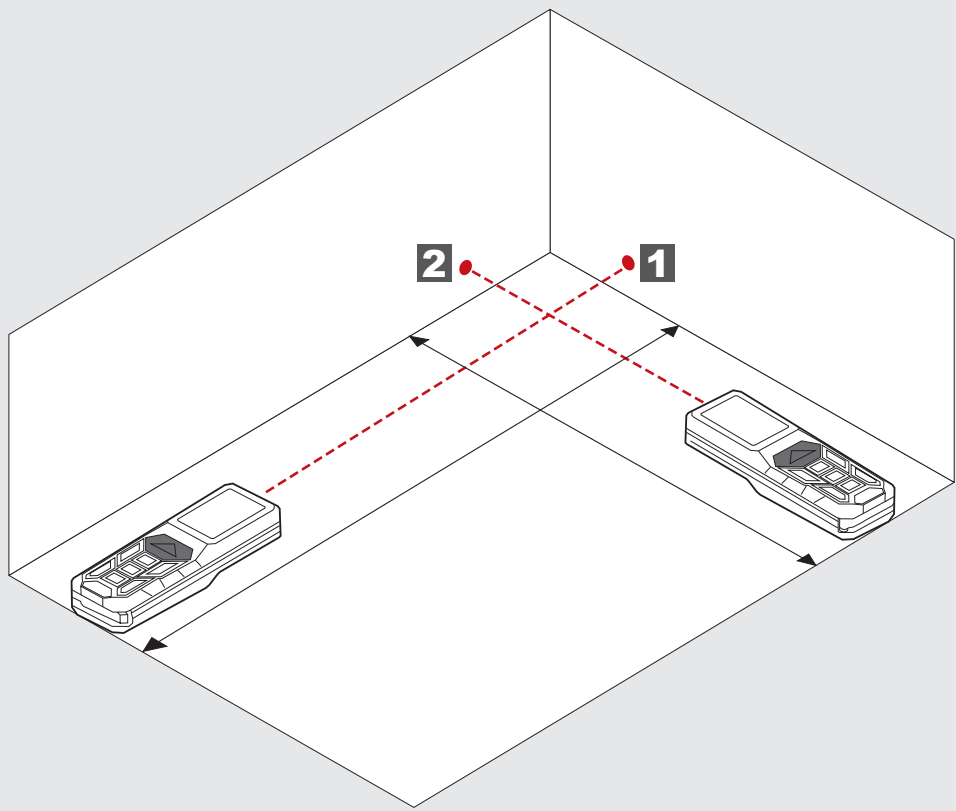
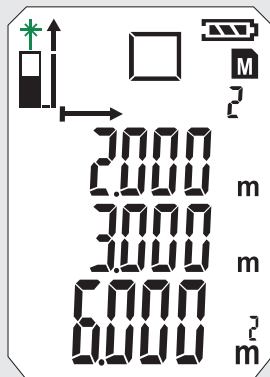
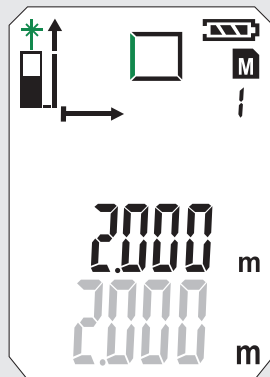
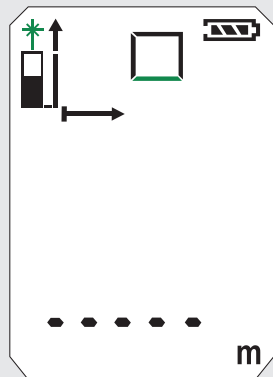
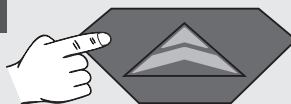

RUUMALA MÕOTMINE

0



1

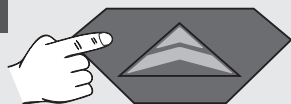

2

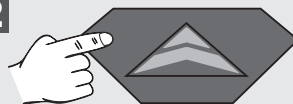

3

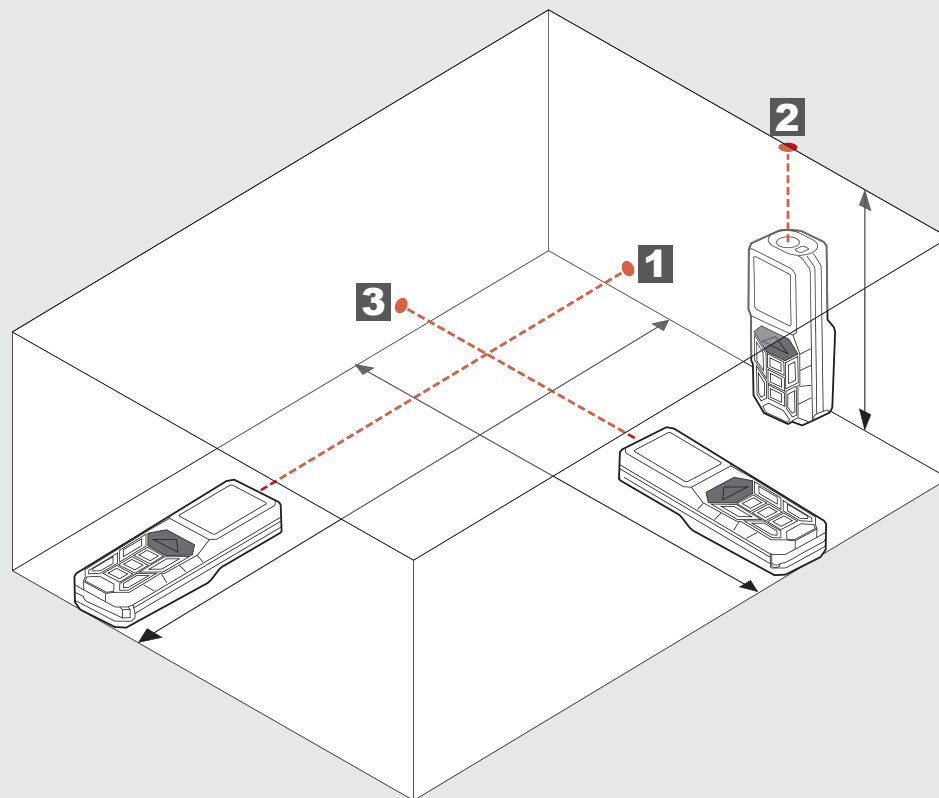
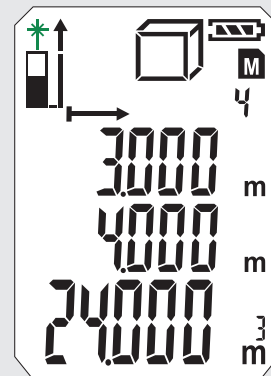
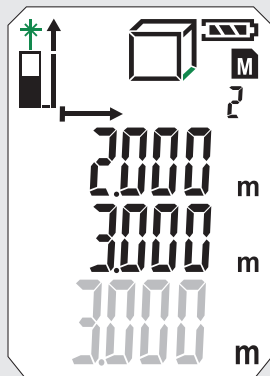
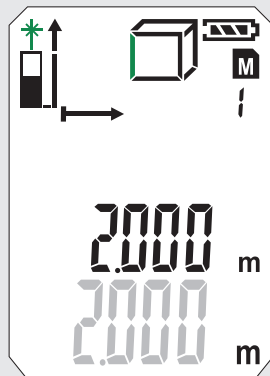
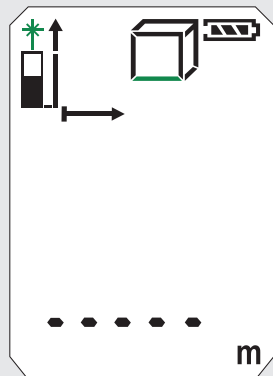
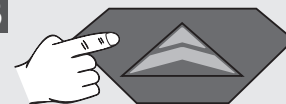

KAUDNE MÕOTMINE (PYTHAGORAS 1)

0



1

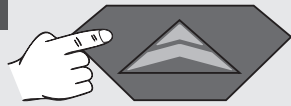

2

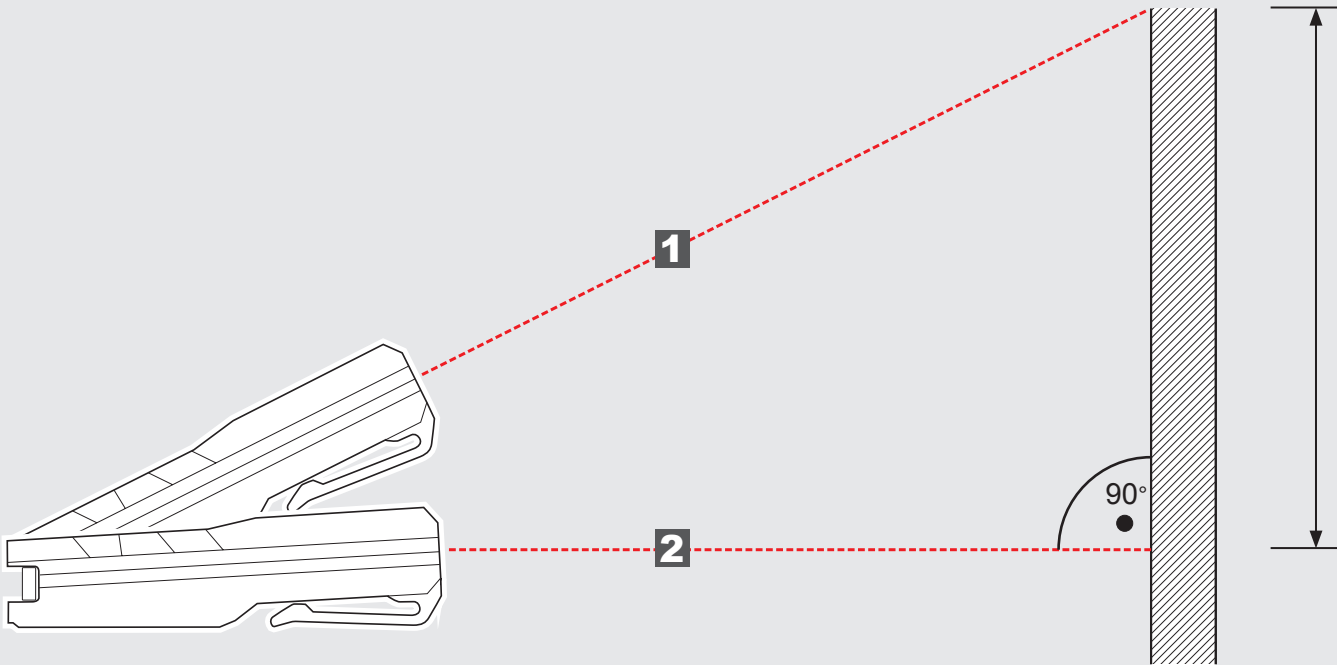
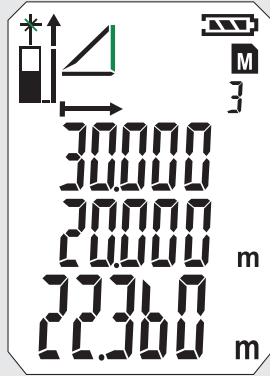
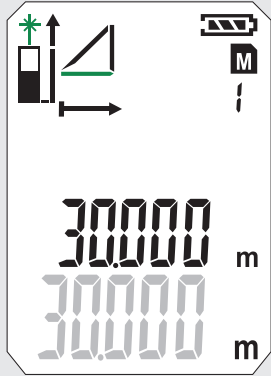
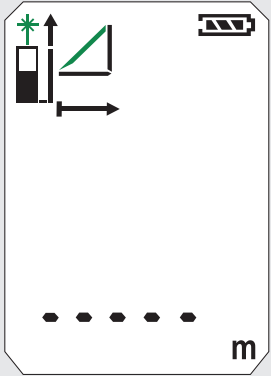
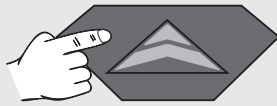

KAUDNE MÕOTMINE (PYTHAGORAS 2)

0



1

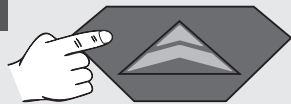

2

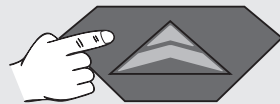

3

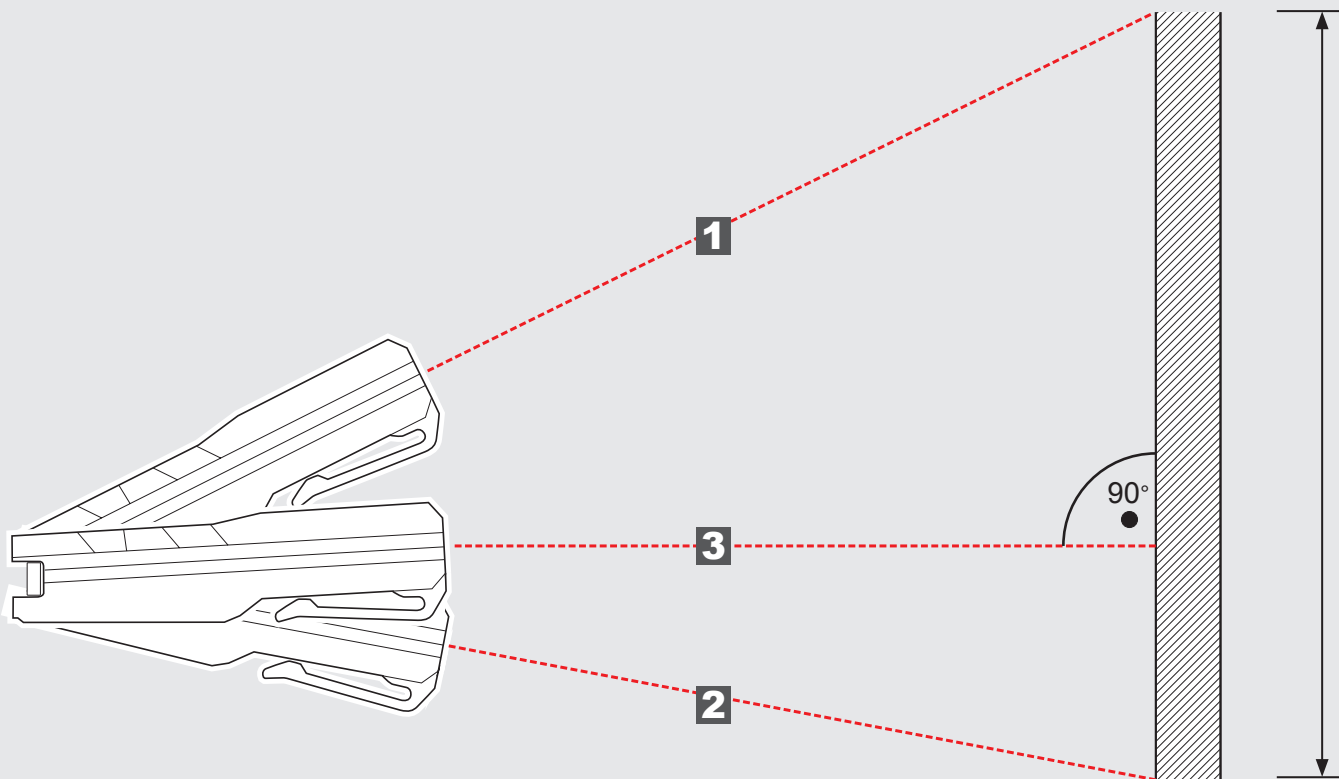
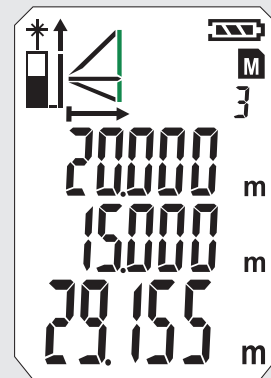
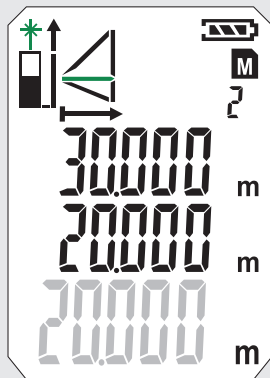
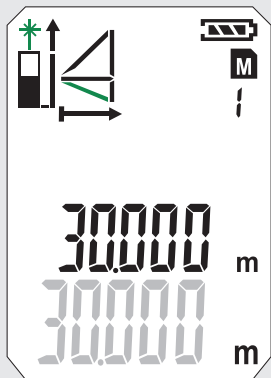
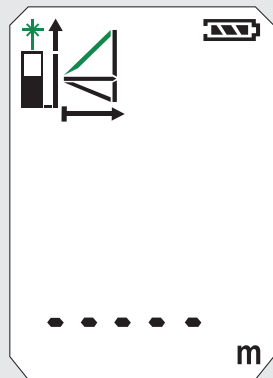
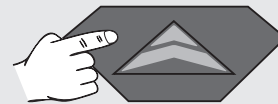

KAUDNE MÕOTMINE (PYTHAGORAS 3)

1



2

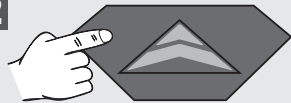

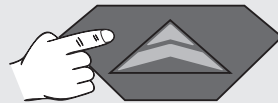

3

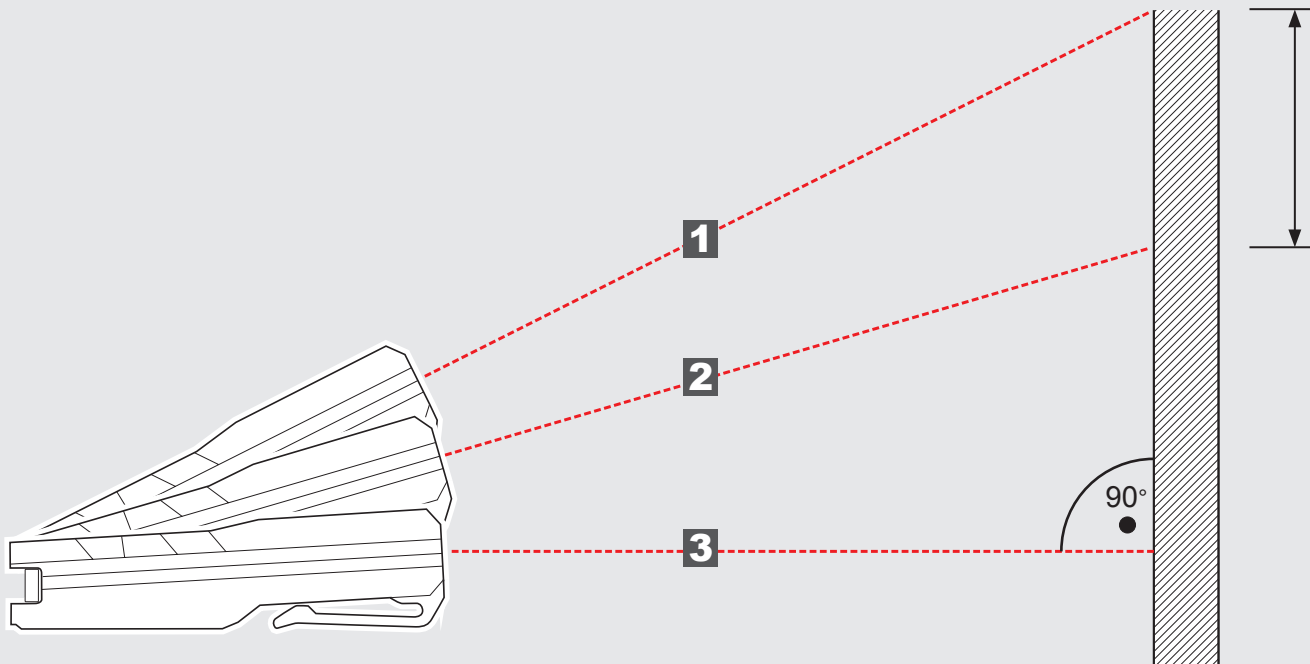
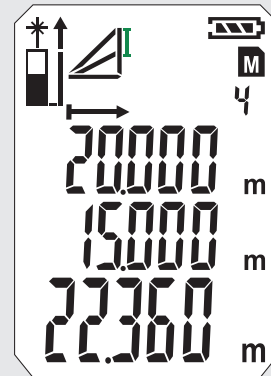
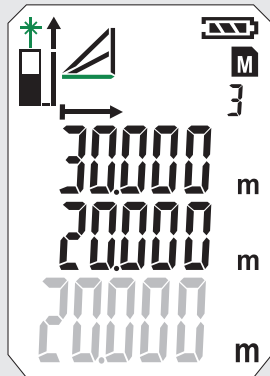
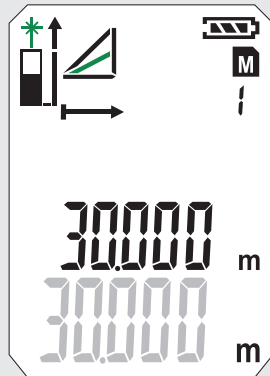
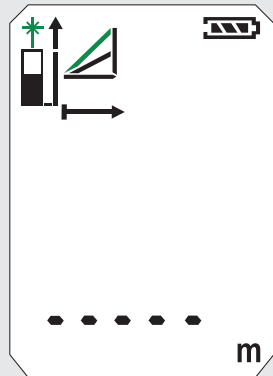
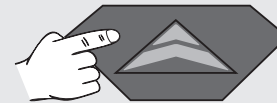

4

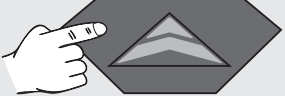
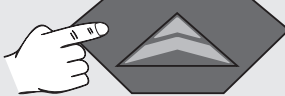
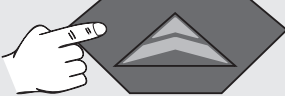
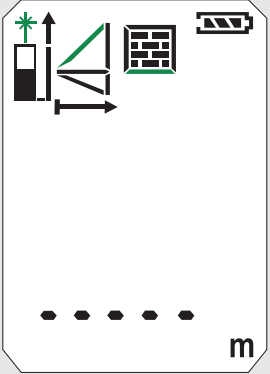
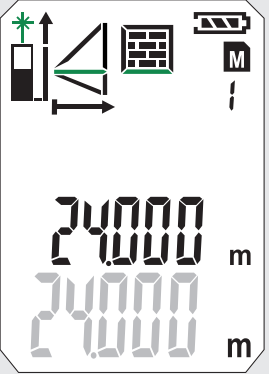
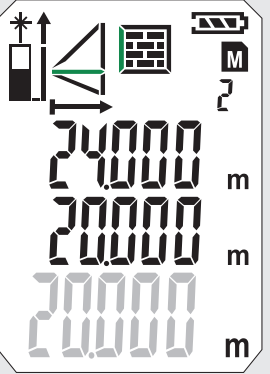
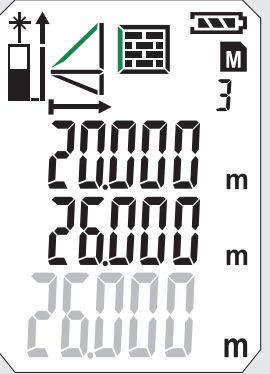
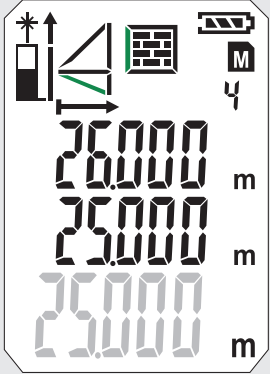

SEINA PINDALA MÕOTMINE (STSENAARIUM 1)

0 	1 	2 	3 	4 
				

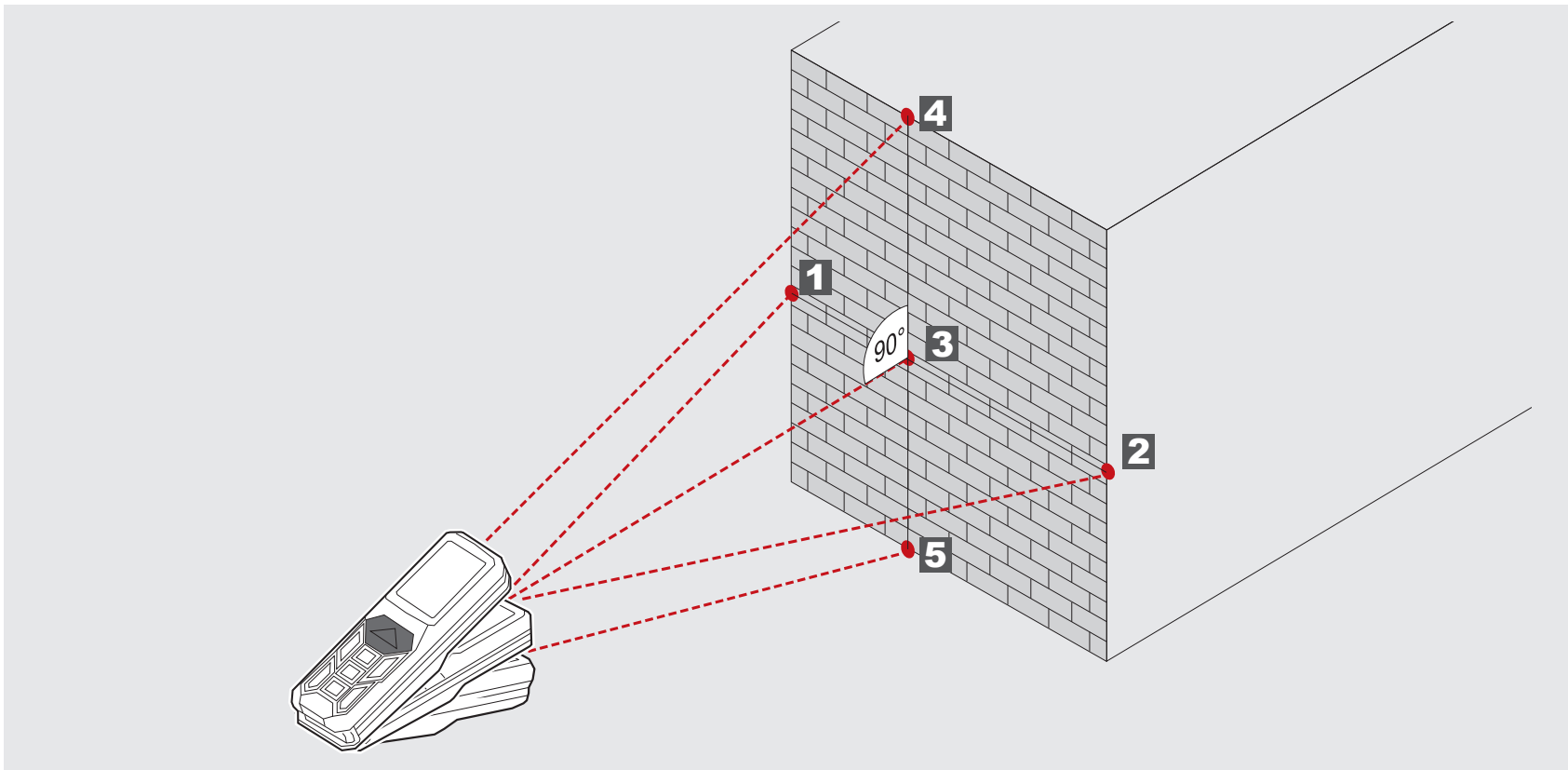





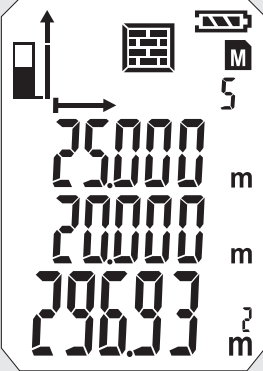









5



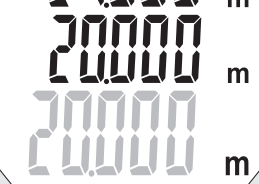

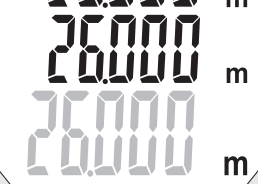
SEINA PINDALA MÕOTMINE (STSENAARIUM 2)

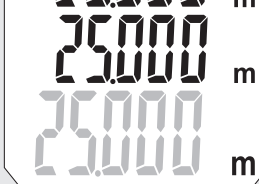
0 	1 	2 	3 	4 
 	 	 	 	 

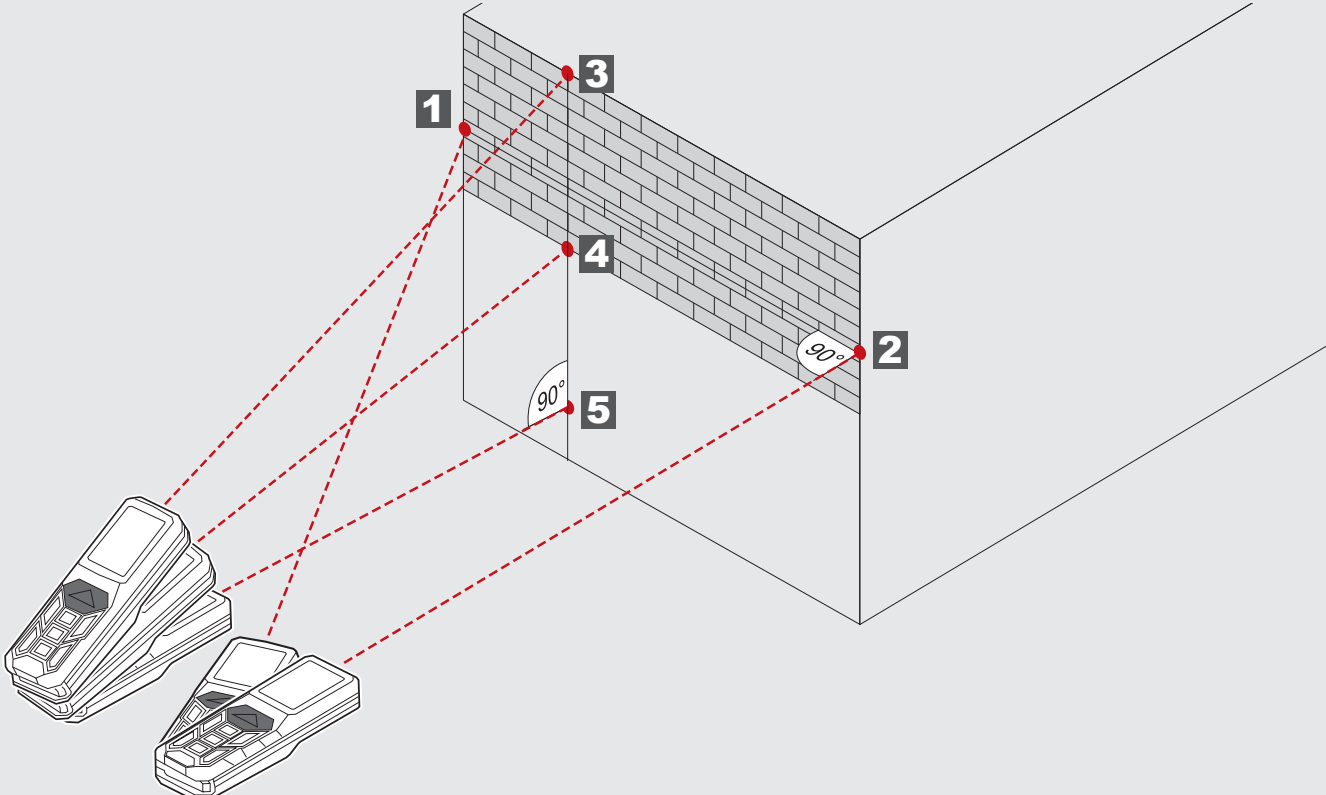

5



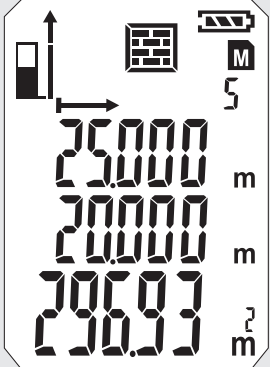



TAIMER

Taimeriga on võimalik mõõtmist viivitusega vallandada, et nt koostedetaili mõõtekiires positsioneerida.

Vajutage klahvi 

- Ilmub sümbol 
- Klahvi  vajutamisega saab taimerit vahemikus 3 kuni 15 sek seadistada.

Vajutage klahvi 

- Sekundeid loendatakse kuni mõõtmiseni alla.
- 0 juures käivitatakse mõõtmine.

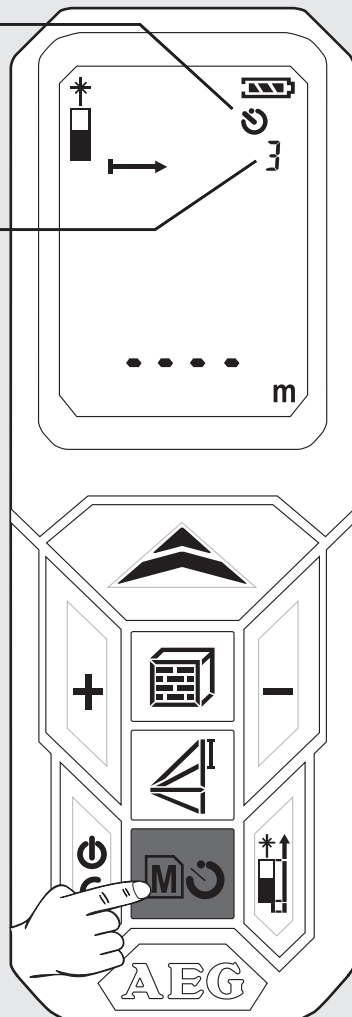

MÄLU

Mõõteväärtused talletatakse automaatselt jooksvalt mälu.

Salvestatud väärtusi saab klahviga  ette kutsuda.

Vajutage 2 sek klahvi 

- Ilmuvad sümbol ja mälukoht.
- Näidatakse juurdekuuluvat mõõtesuurust.
- Salvestatud väärtust näidatakse peareal.
- Navigeerige +/- klahvidega

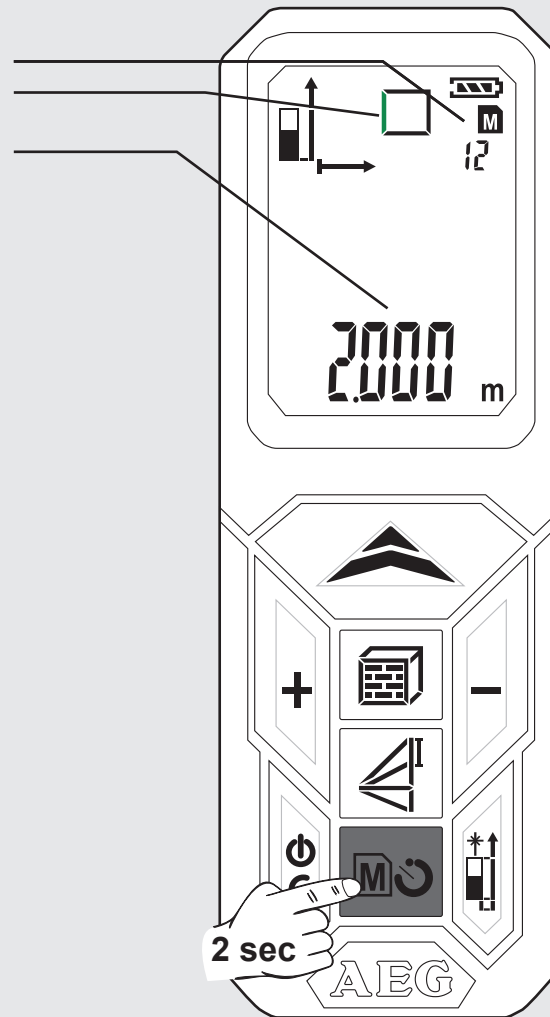

PÕHILINE TALITLUSVIIS PINDALA MÕOTMISE (1) NÄITEL



1 Sisselülitamine

Vajutage klahvi .

⚠ Tähelepanu! Laserkiir sees!
Ärge suunake inimeste peale!

2 Mõõtmistasandi valimine

Standardseadistus pärast sisselülitamist: taga

 1x vajutamine -> nurgapliiats
 2x vajutamine -> ees
 3x vajutamine -> taga

3 Funktsiooni valimine

Pärast sisselülitamist on seade alati pikkuse mõõtmise peal.

 1x vajutamine - pikkuse mõõtmine

4 Pikkuse mõõtmine

Joondage seade välja ja vajutage klahvi .

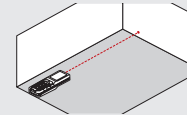

5 Laiuse mõõtmine

Joondage seade välja ja vajutage klahvi .

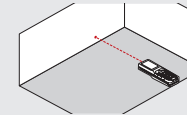

Laseri sümbol vilgub (vilkumist kujutatakse roheliselt).

Näidatakse sümbolit

- Ilmub sümbol
- Mõõtesuurus vilgub (vilkumist kujutatakse roheliselt)

- Mõõteväärtus ilmub hetkeks pearele.
- Mõõteväärtus hüppab 1 sek pärast selle kohal asuvale reale.
Mõõteväärtused talletatakse jooksvate numbrite all mällu.
Teine mõõtesuurus vilgub. Seade on valmis teise väärtuse mõõtmiseks.

- Mõõteväärtus ilmub hetkeks pearele.
- Mõõteväärtus hüppab 1 sek pärast selle kohal asuvale reale.
Mõõteväärtused talletatakse jooksvate numbrite all mällu.
- Tulemust näidatakse peareal ja talletatakse jooksva numbriga all mällu.

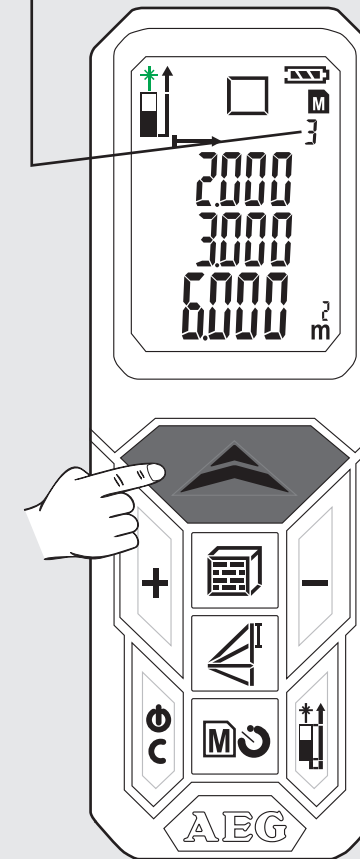
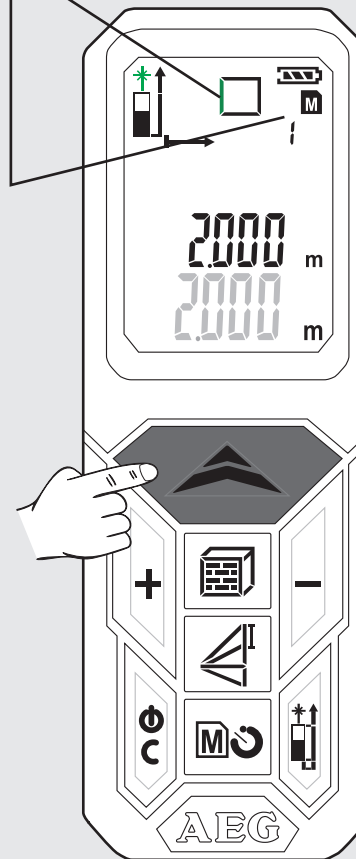
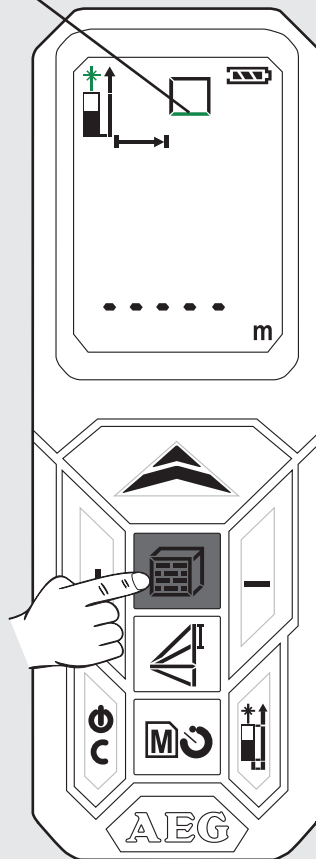
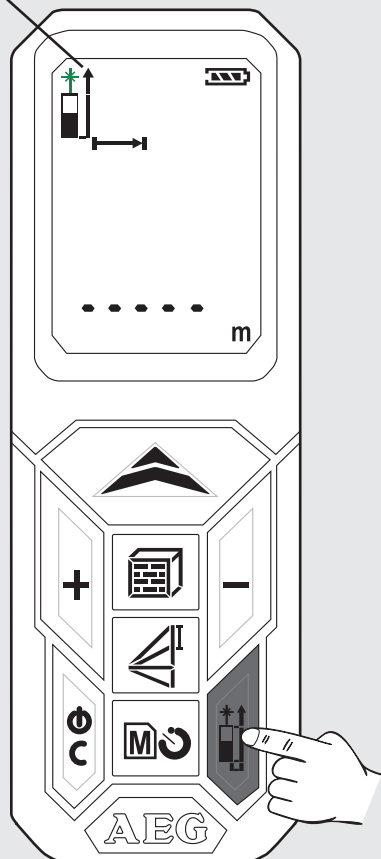
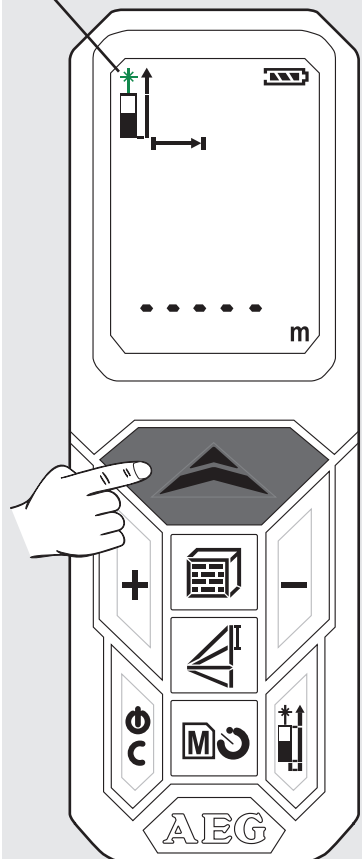

PÕHILINE TALITLUSVIIS PINDALA MÕÖTMISE (2) NÄITEL

6 Salvestatud väärtuste ettekutsumine

Vajutage 2 sek klahvi .
Vajutage klahvi + või -

7 Mälust lahkumine

Vajutage klahvi .

8 Väljalülitamine

Vajutage 2 sek klahvi 
(eelnevalt tuleb mälust lahkuda).

- Salvestatud väärtusi näidatakse peareal.

- Näidatakse juurdekuuluvat sümbolit ja mõõtesuurus vilgub (vilkumist kujutatakse roheliselt).

- Seade lülitub välja.

- Kui 3 minuti jooksul ei vajutata ühtki klahvi, siis lülitub seade automaatselt välja.

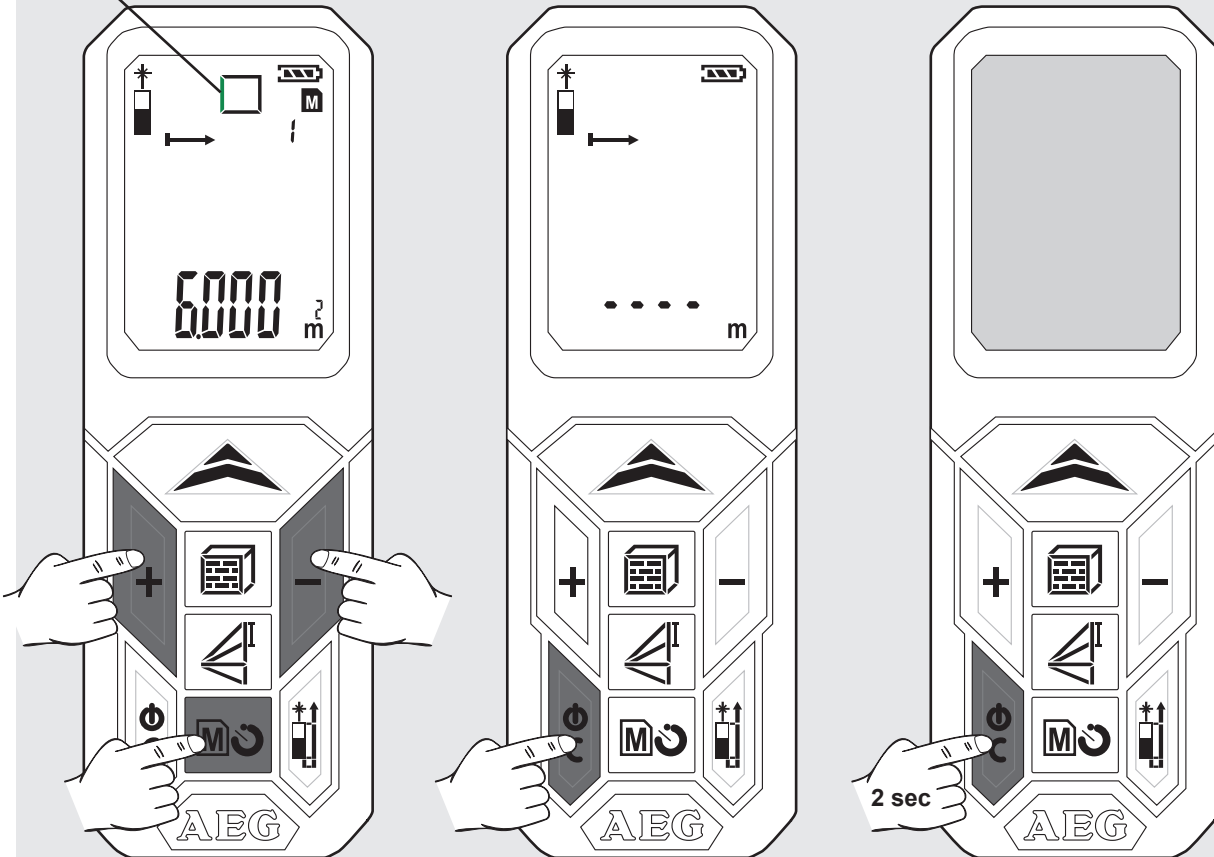

СОДЕРЖАНИЕ

Важные инструкции по технике безопасности.....	1
Технические данные	2
Использование	2
Таблица кодов неисправностей.....	2
Обзор	3
Замена батареи	4
Угловой штифт	4
Поясной держатель	4
Функциональная кнопка, Пифагор, плоскость измерения.....	5
Простое измерение длины.....	6
Непрерывное измерение / измерение минимум-максимум	7
Измерение со сложением / вычитанием.....	8
Измерение площади.....	9
Измерение объема	10
Косвенное измерение (Пифагор 1)	11
Косвенное измерение (Пифагор 2)	12
Косвенное измерение (Пифагор 3)	13
Измерение площади стены (сценарий 1)	14
Измерение площади стены (сценарий 2)	15
Таймер	16
Память	16
Основной принцип действия на примере измерения площади (1).....	17
Основной принцип действия на примере измерения площади (2).....	18

ВАЖНЫЕ ИНСТРУКЦИИ ПО ТЕХНИКЕ БЕЗОПАСНОСТИ



Перед использованием продукции внимательно ознакомьтесь с инструкциями по технике безопасности и руководством пользователя, которые прилагаются на CD.

Классификация лазера

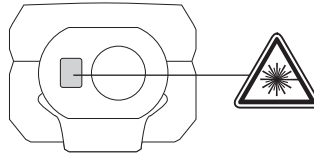

ВНИМАНИЕ!

Данное устройство является лазерным изделием класса 2 и соответствует IEC 60825-1:2007.



Надпись

Перед первым вводом в эксплуатацию заклейте английский текст на фирменной табличке прилагаемой наклейкой на вашем языке.

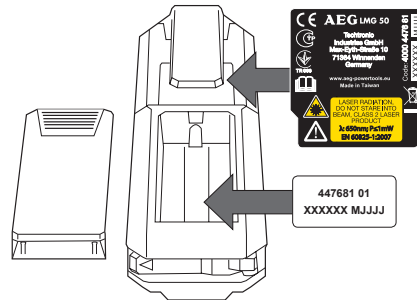

Предупреждение:

Не допускать непосредственного визуального контакта. Лазерный луч может ослепить и привести к кратковременной потере зрения.

Не смотрите в лазерный луч и не направляйте его без надобности на других людей.

Не ослепляйте лучом других людей.

Предупреждение:

Не пользоваться лазерным прибором рядом с детьми и не разрешать детям использовать его.

Внимание! Лазерный луч может отражаться от определенных поверхностей и попадать на оператора или других людей.

Держите конечности на безопасном расстоянии от движущихся частей.

Периодически проводите контрольные измерения. В частности, проводите их перед, в течение или после важных измерений.

Будьте внимательны! Если устройство неисправно, падало, было использовано по назначению или в его конструкцию были внесены изменения, результаты измерений могут быть неверными.

Внимание! Ознакомьтесь с элементами управления и правильным использованием садового инструмента.

Лазерный измерительный прибор имеет ограниченную область применения. (См. раздел "Технические характеристики"). Попытки выполнения измерений за пределами максимального и минимального диапазона могут привести к погрешностям. Использование при неблагоприятных условиях, например, при сильной жаре, сильном холоде, очень ярком солнечном свете, дожде, снеге, тумане или прочих снижающих безопасность условиях может привести к погрешностям измерения.

Если лазерный измерительный прибор перемещается из теплых условий в холодные (или наоборот), необходимо подождать, пока прибор не адаптируется к новой температуре.

Лазерный измерительный прибор всегда следует хранить в помещениях, защищать от тряски, вибраций или экстремальных температур.

Защищать лазерный измерительный прибор от пыли, влаги и высокой влажности воздуха. Они могут повредить внутренние компоненты или повлиять на точность.

Запрещается использовать агрессивные чистящие средства или растворители. Очищать только с помощью чистой мягкой салфетки.

Избегать сильных ударов по лазерному измерительному прибору или его падению. Точность прибора следует проверять, если он упал или подвергся другим механическим нагрузкам.

Необходимые ремонтные работы на этом лазерном приборе разрешается выполнять только авторизованному квалифицированному персоналу.

Эксплуатировать устройство в опасных зонах или в агрессивных средах запрещается.

Для зарядки батарей используйте только зарядные устройства, рекомендованные производителем.



Использованные батарейки не подлежат утилизации с бытовыми отходами. Позаботиться об окружающей среде, сдать их на сборный пункт, организованный в соответствии с государственными или местными нормами. Изделие не подлежит утилизации с бытовыми отходами. Утилизировать изделие надлежащим образом в соответствии с государственными нормами, действующими в вашей стране. Придерживаться национальных или местных нормативов. За информацией по утилизации обращайтесь в местные органы или к вашему дилеру.



Знак CE

ТЕХНИЧЕСКИЕ ДАННЫЕ

Класс защиты	IP54 (пыле и брызгозащищенный)
Оптика	14 мм
Фокус	35 мм
Диапазон измерений макс.	50 метров (допуск: 55 м)
Диапазон измерений мин.	0,05 метра
Абсолютная точность при < 10 м	± 1,5 мм (макс.)
Стабильность повторяемости при < 10 м	± 1,5 мм (типично макс. 2σ)
Стабильность повторяемости при > 10 м	повышение ± 0,25 мм / метр (типично макс. 2σ)
Время измерения	0,5 с
Тип дисплея	ЖК (22,7 мм x 31 мм)
Электропитание	AAA 2x (щелочная батарея)
Длительность работы батареи	10000 (единичное измерение)
Выходная мощность лазера	0,6 мВт ~ 0,95 мВт (класс 2, 650нм)
Размер лазерной точки	25 x 30 мм при 16 м (макс.)
Вертикальный угол лазерного луча	+1 градус
Горизонтальный угол лазерного луча	±1 градус
Автоматическое отключение прибора	180 секунд
Автоматическое отключение лазера	30 секунд
Диапазон рабочих температур	от -10°C до +50°C
Диапазон температуры хранения	от -25°C до +70°C
Вес без батареи	80 г

ИСПОЛЬЗОВАНИЕ

Лазерный измерительный прибор подходит для измерения дистанции и наклона.

Не пользуйтесь данным инструментом способом, отличным от указанного для нормального применения.

ТАБЛИЦА КОДОВ НЕИСПРАВНОСТЕЙ

Код	Описание	Устранение
Err01	За пределами диапазона измерений	Выполнить измерение в предусмотренном диапазоне.
Err02	Слишком слабый отражаемый сигнал	Выбрать лучшую поверхность.
Err03	За диапазона индикации (макс. значение: 99.999), например, результат площади или объема за пределами индикации	Проверить, правильные ли значения и этапы.
Err04	Ошибка в пифагоровом измерении	Проверить, правильные ли значения и этапы.
Err05	Слабый заряд батареи	Вставить новые батарейки.
Err06	За пределами диапазона рабочих температур	Выполнить измерение в заданном диапазоне рабочих температур.
Err07	Слишком светлый окружающий свет	Затемнить целевую область.

Пифагор
Разность высот

Плоскость измерения

Измерение длины

Минимум / максимум непрерывного измерения

Сложение / вычитание

ВКЛ. / ИЗМЕРЕНИЕ

- ▶ Вкл.
- ▶ Измерение
- ▶ Непрерывное измерение (удерживать нажатой 2 с) функция Мин. / Макс.

СЛОЖЕНИЕ

- ▶ Прибавить значение
- ▶ Навигация по памяти

ПЛОЩАДЬ / ОБЪЕМ

- ▶ Площадь (нажать 1 раз)
- ▶ Объем (нажать 2 раза)
- ▶ Косвенное измерение поверхности нажать 3/4 раза)

ВКЛЮЧЕНИЕ

- ▶ Вкл.
- ▶ Выкл. (удерживать нажатой 2 с)
- ▶ Сброс

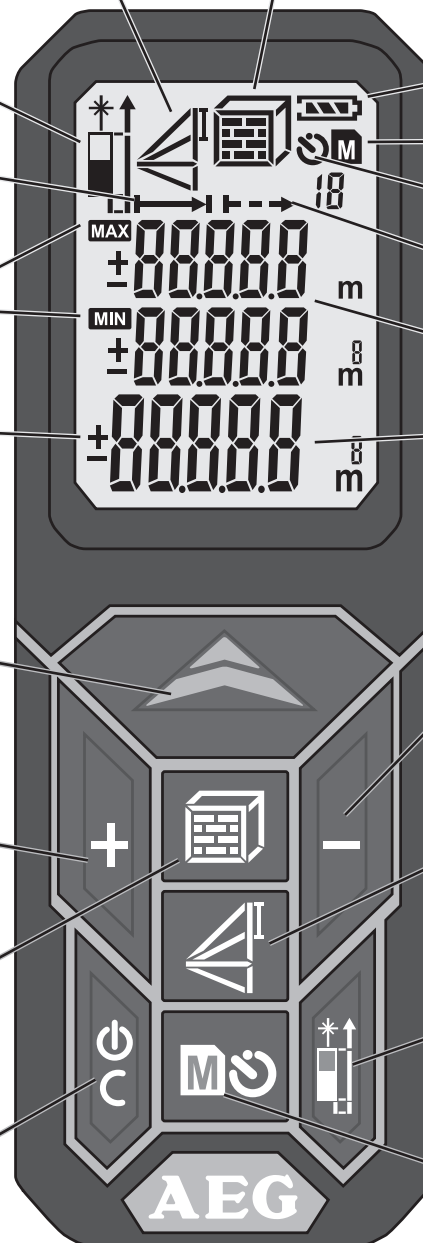

Площадь / объем
Косвенное измерение поверхности

Статус батареи

Память

Таймер

Непрерывное измерение

Промежуточные значения

Общее значение

ВЫЧИТАНИЕ

- ▶ Отнять значение
- ▶ Навигация по памяти

ПИФАГОР

- ▶ Пифагор 1 (нажать 1 раз)
- ▶ Пифагор 2 (нажать 2 раза)
- ▶ Пифагор 3 (нажать 3 раза)

ИЗМЕНЕНИЕ ПЛОСКОСТИ ИЗМЕРЕНИЯ

- ▶ Спереди
- ▶ Сзади
- ▶ Угловой штифт

ПАМЯТЬ

- ▶ Таймер 3-15 с (нажать 1 раз)
- ▶ Память 1-20 (нажать 1 раз на 2 с)
- ▶ Навигация по памяти с помощью кнопок +/-

ЗАМЕНА БАТАРЕИ

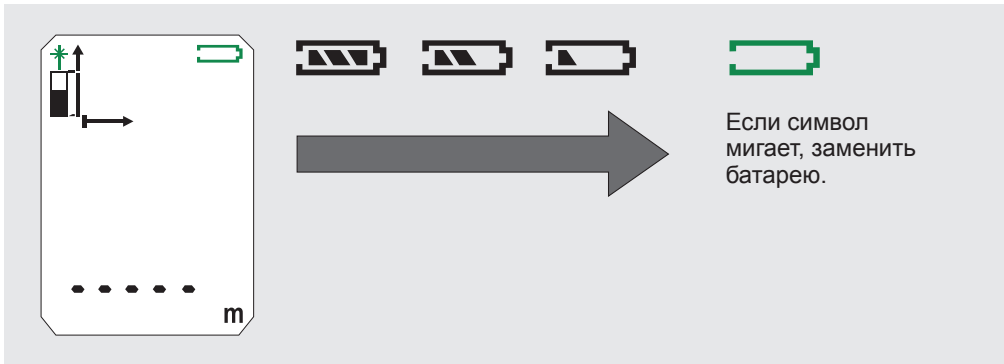

1

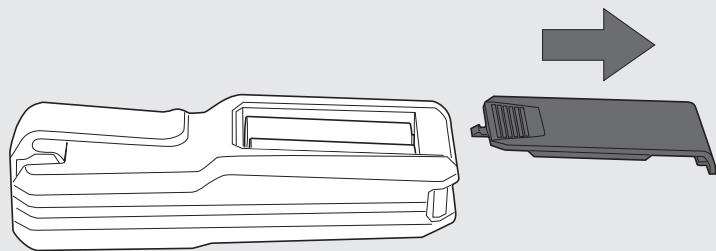

2

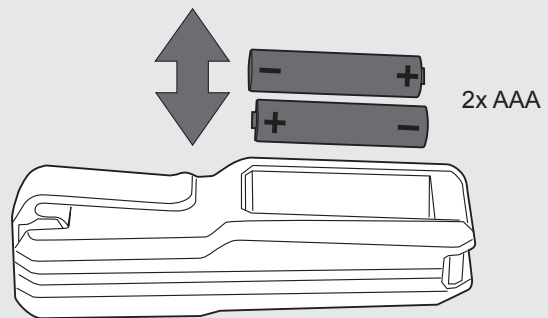

3

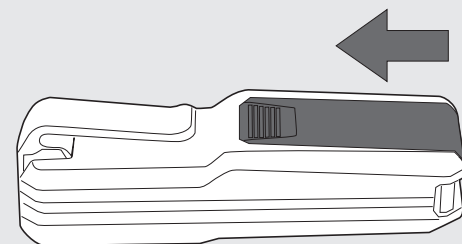

УГЛОВОЙ ШТИФТ

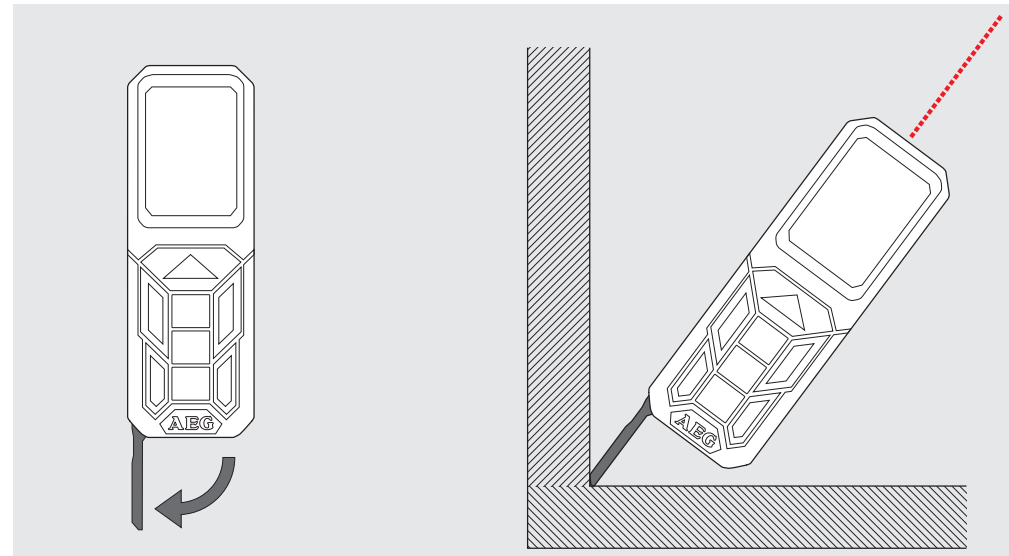

ПОЯСНОЙ ДЕРЖАТЕЛЬ

1

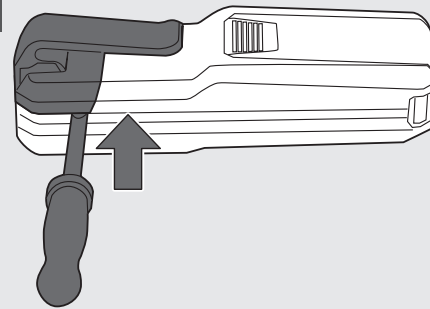

2

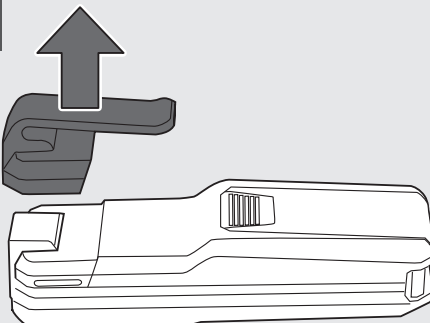

3

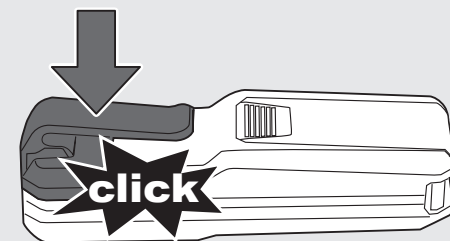

ПРОСТОЕ ИЗМЕРЕНИЕ ДЛИНЫ

0	1	2	3	4

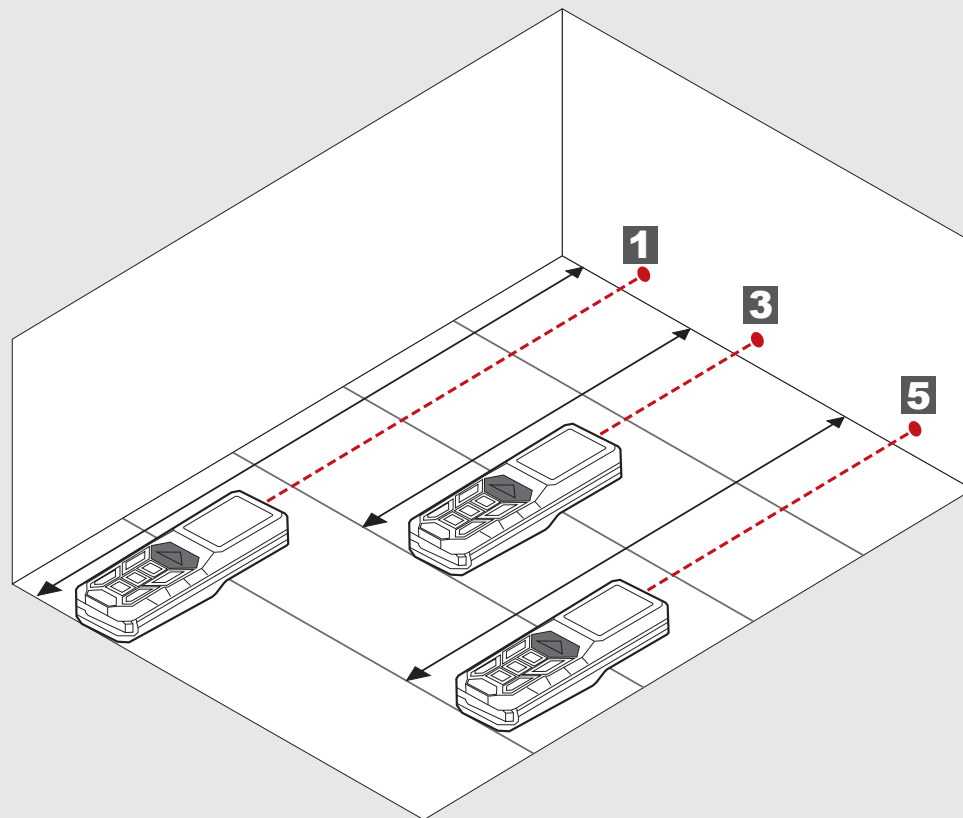

5

НЕПРЕРЫВНОЕ ИЗМЕРЕНИЕ / ИЗМЕРЕНИЕ МИНИМУМ-МАКСИМУМ

0

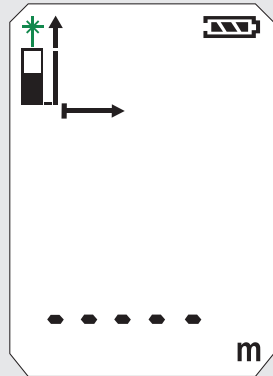

1

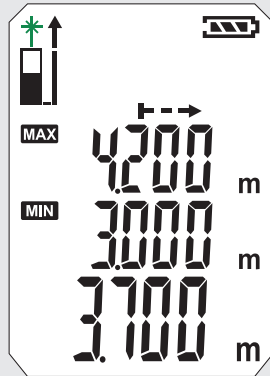
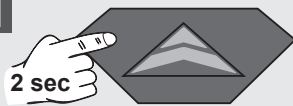

2

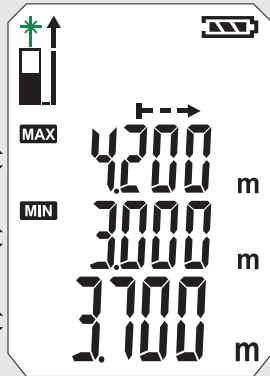

3

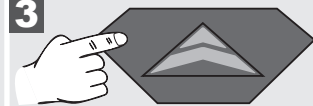

Stop
MIN / MAX

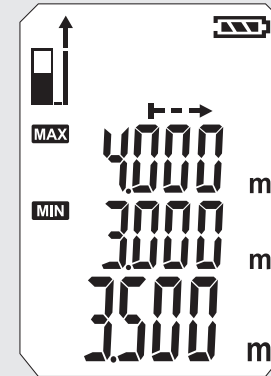

4

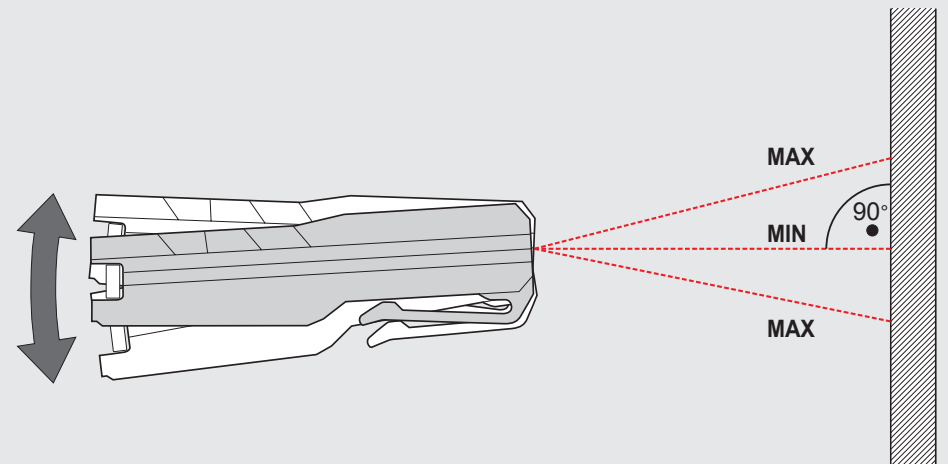
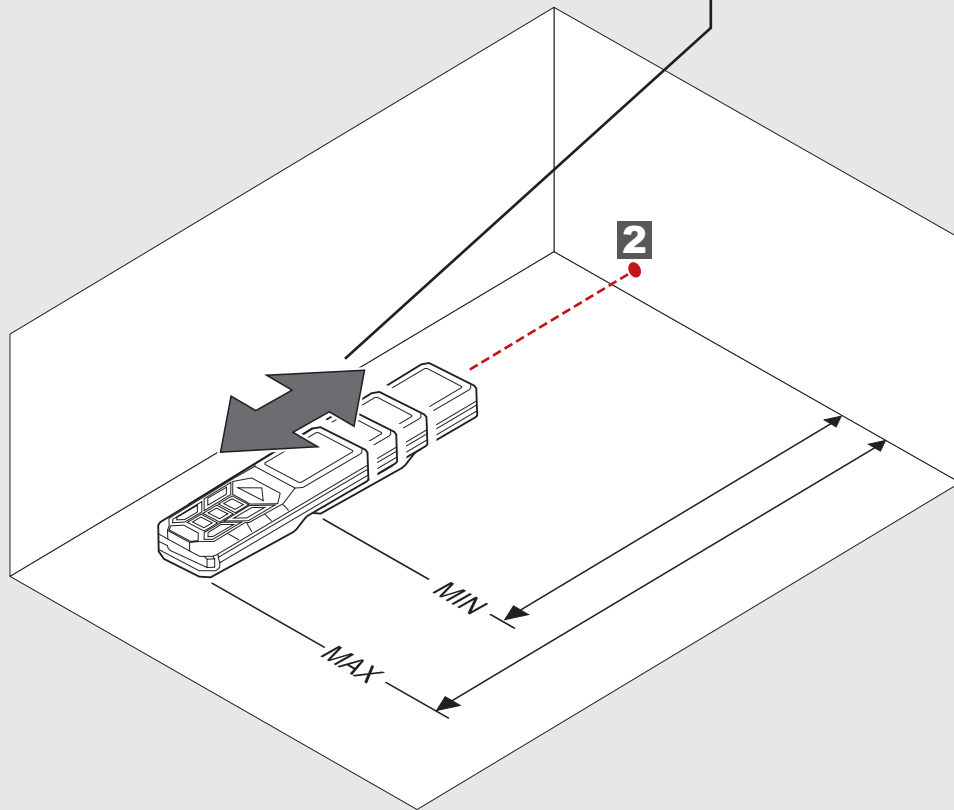
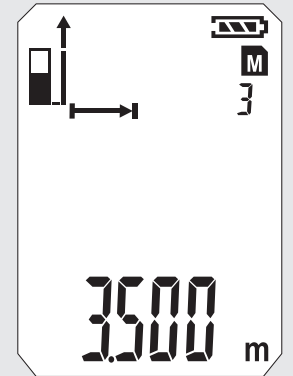

ИЗМЕРЕНИЕ СО СЛОЖЕНИЕМ / ВЫЧИТАНИЕМ

0

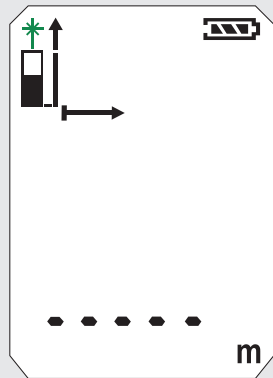

1

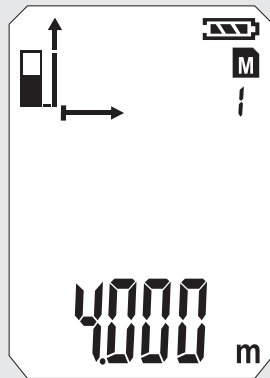
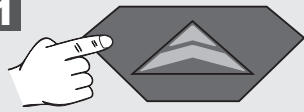

2

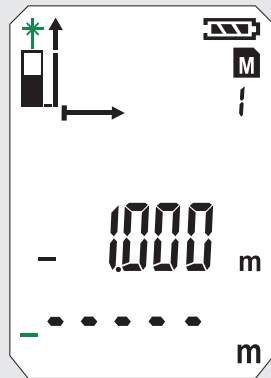
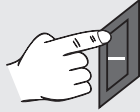

3

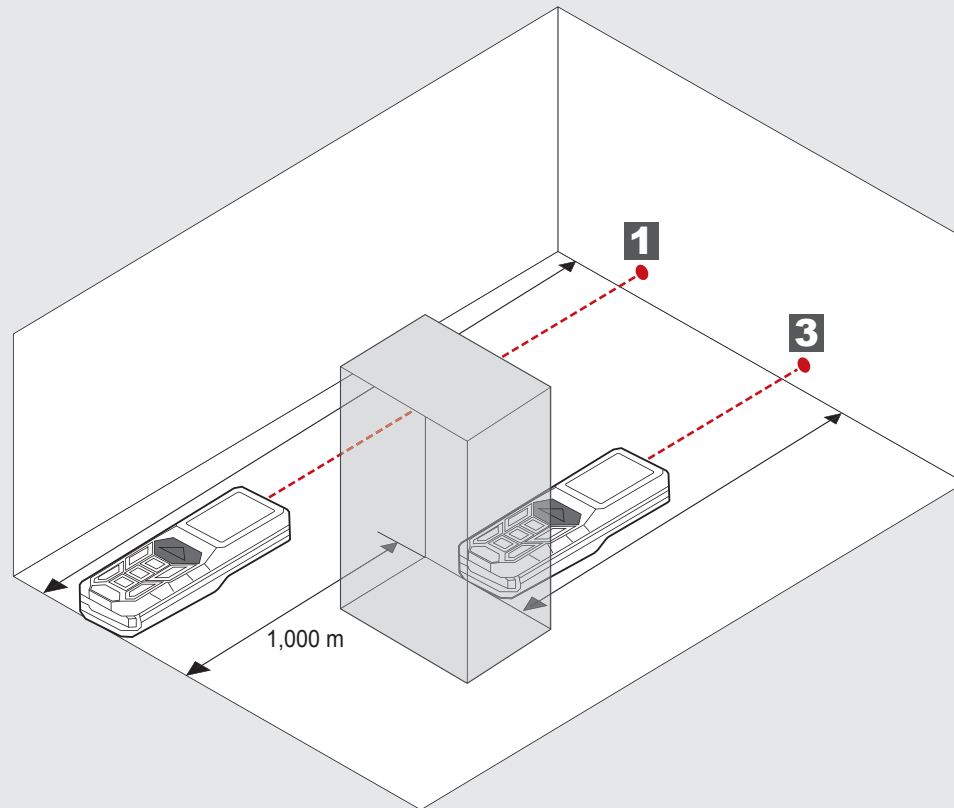
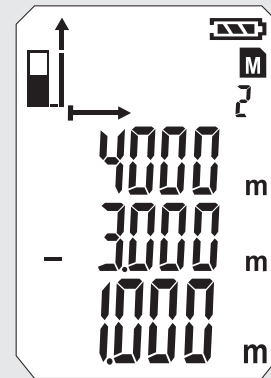
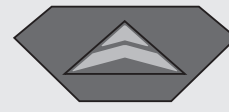

ИЗМЕРЕНИЕ ПЛОЩАДИ

0



1

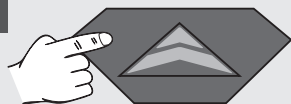

2

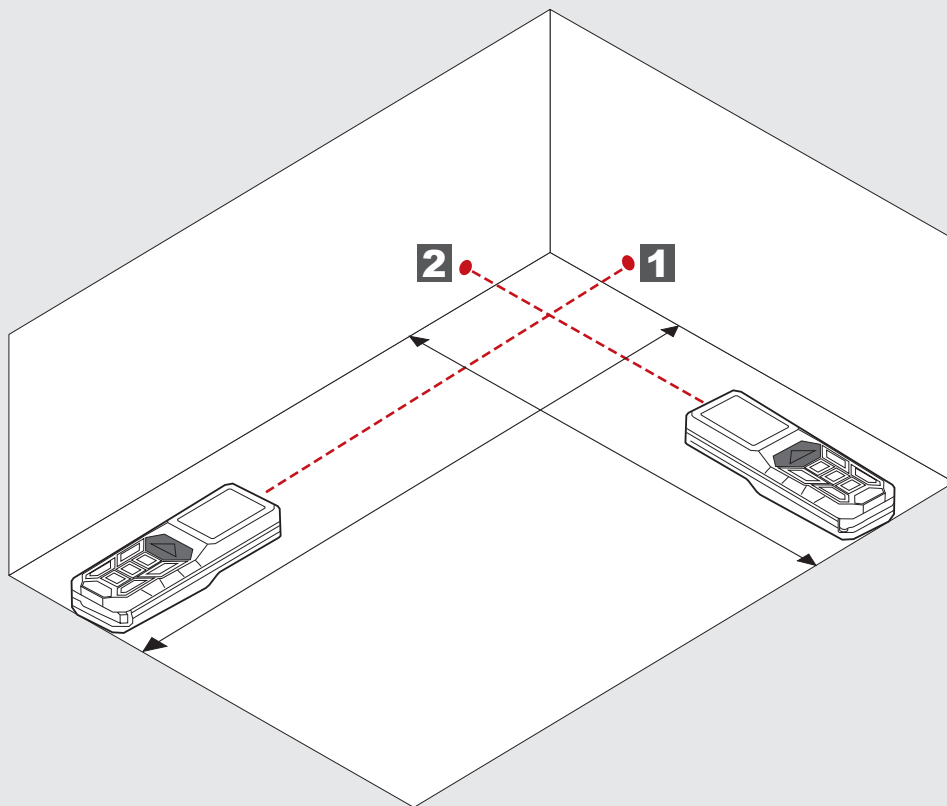
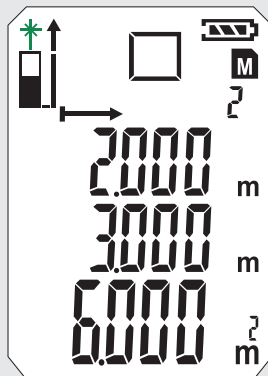
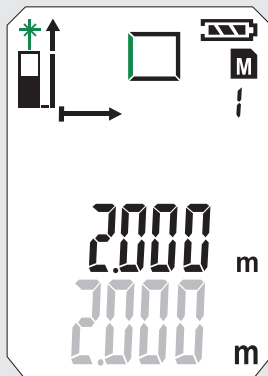
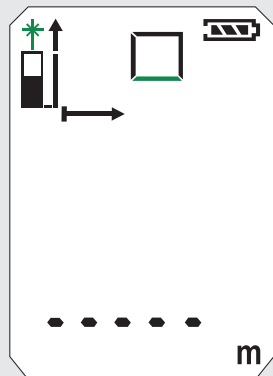
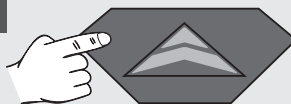

ИЗМЕРЕНИЕ ОБЪЕМА

0



1

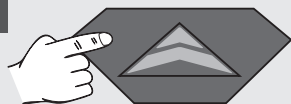

2

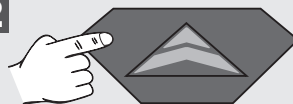

3

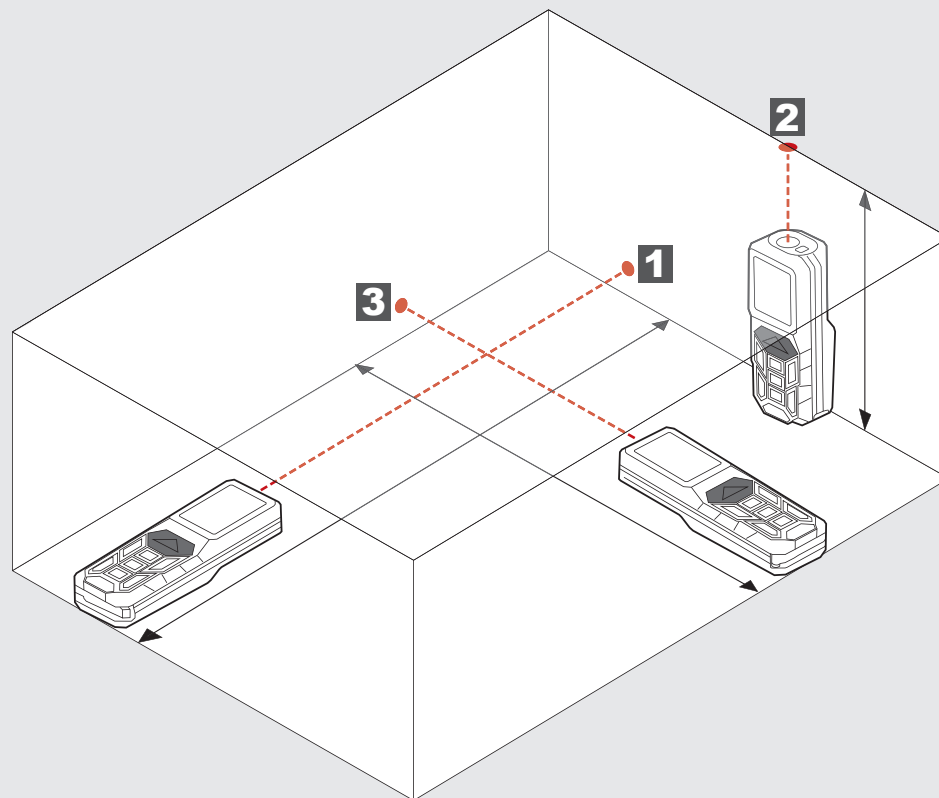
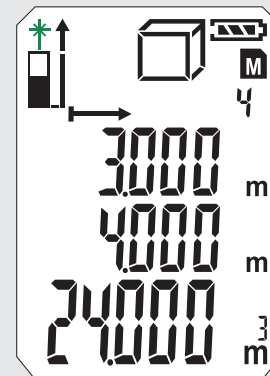
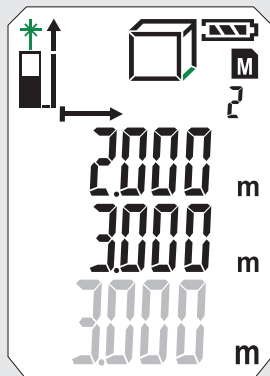
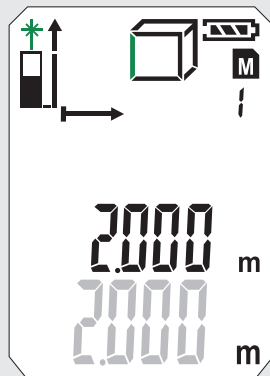
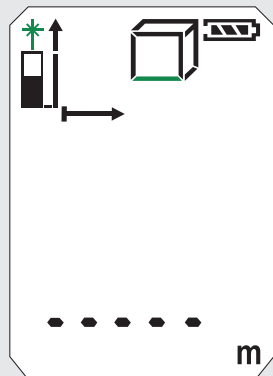
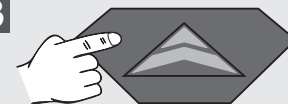

КОСВЕННОЕ ИЗМЕРЕНИЕ (ПИФАГОР 1)

0



1

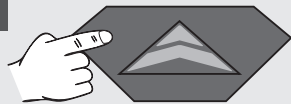

2

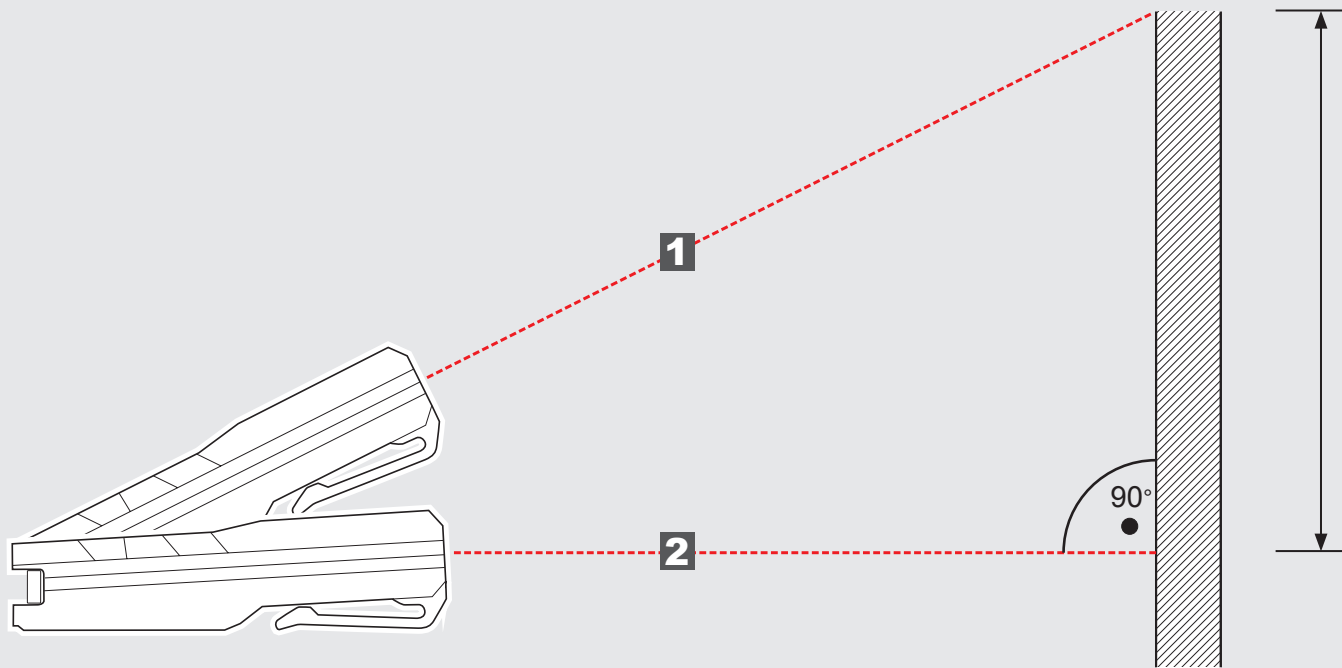
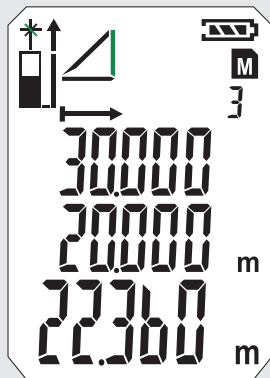
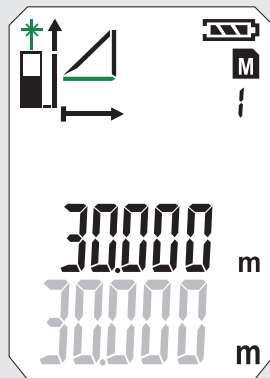
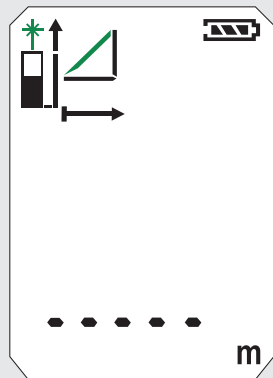
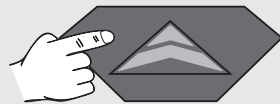

КОСВЕННОЕ ИЗМЕРЕНИЕ (ПИФАГОР 2)

0



1

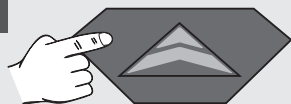

2

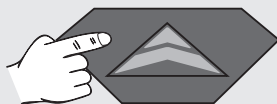

3

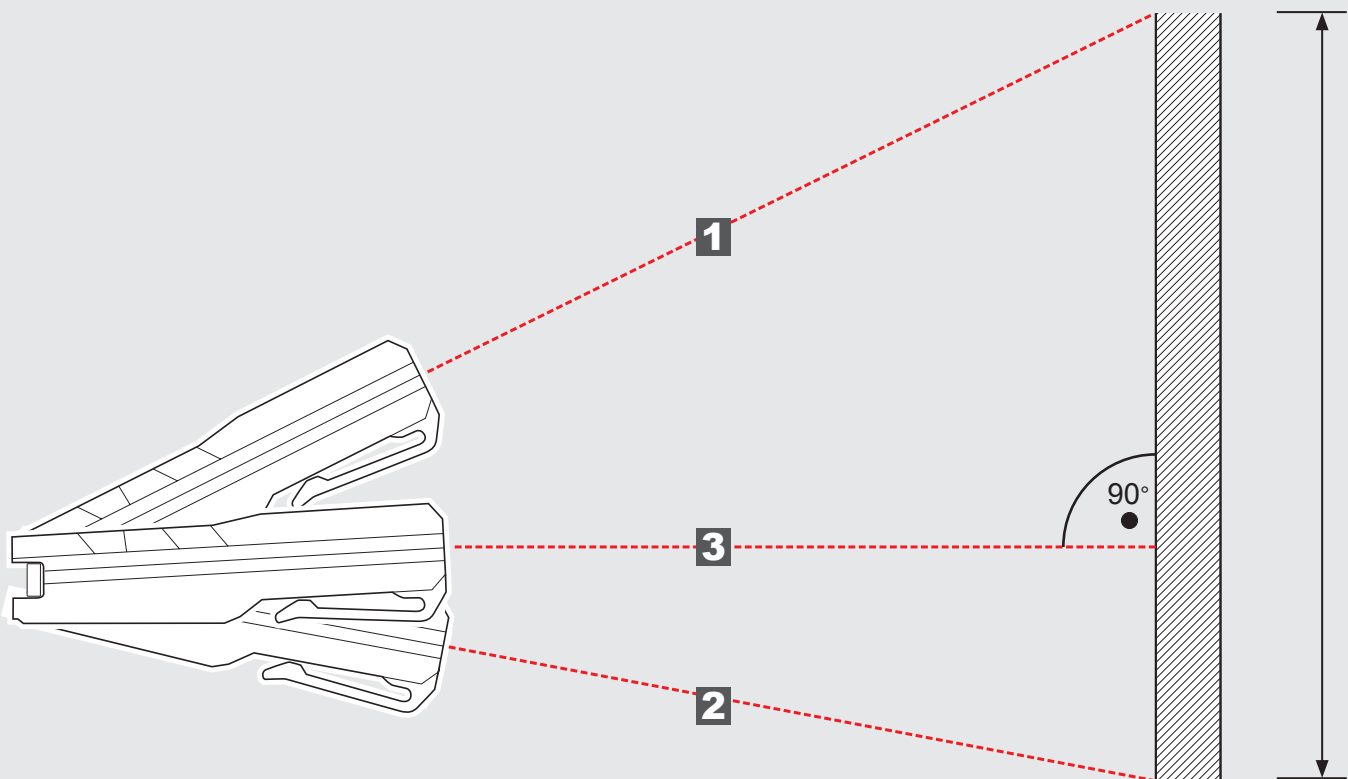
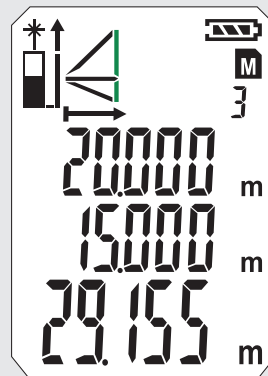
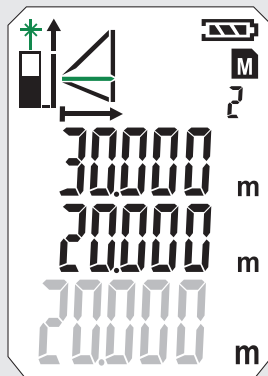
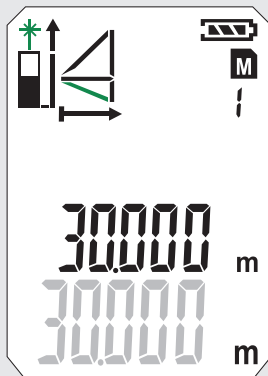
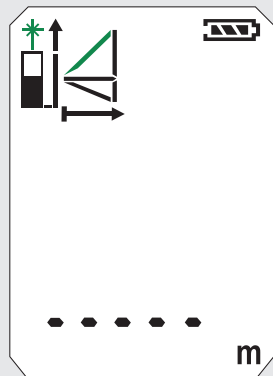

КОСВЕННОЕ ИЗМЕРЕНИЕ (ПИФАГОР 3)

1



2

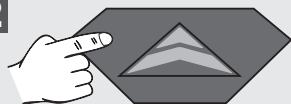



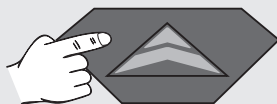



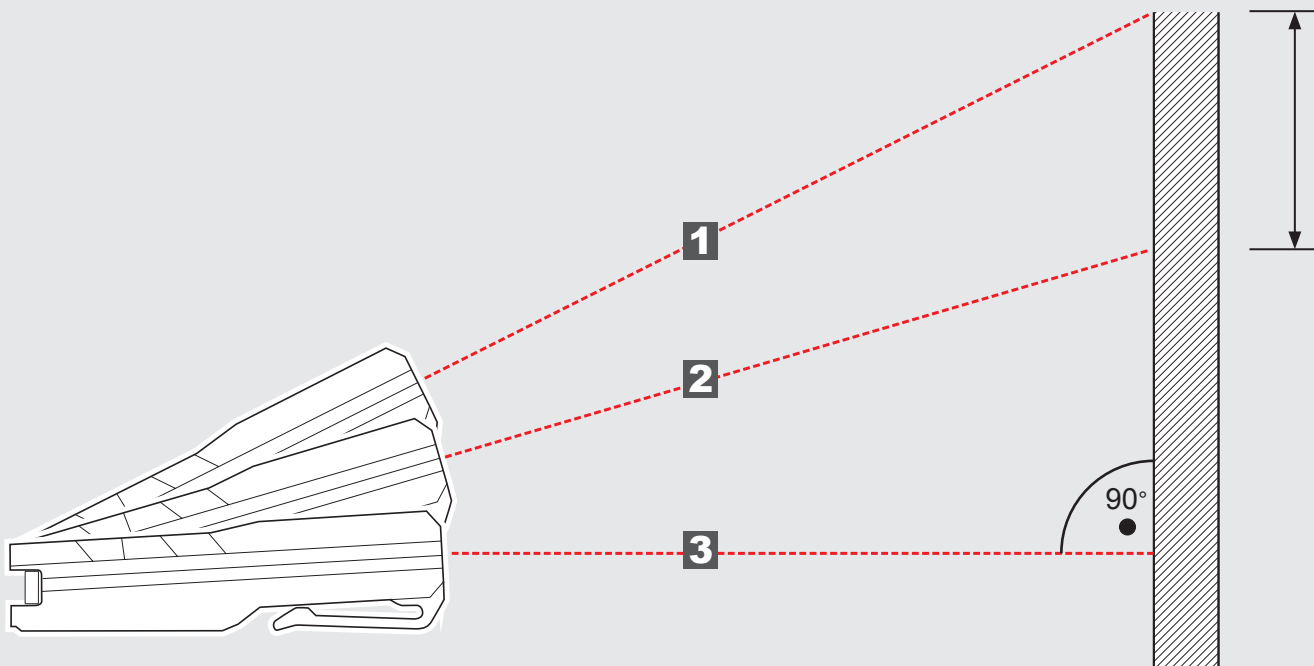
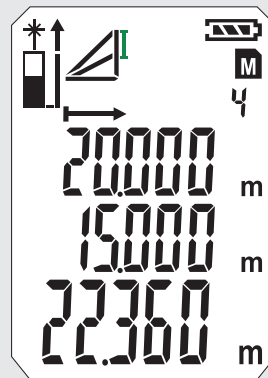
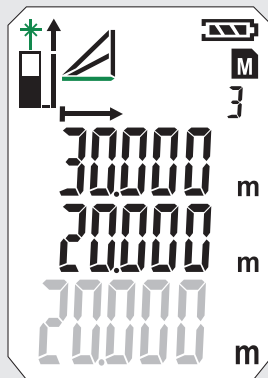
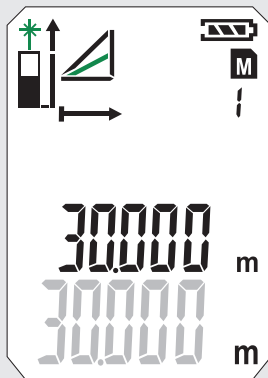
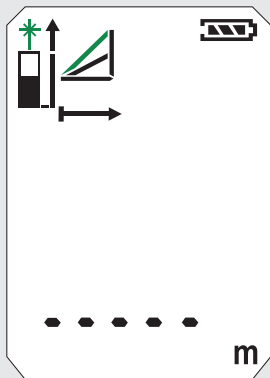

3



4

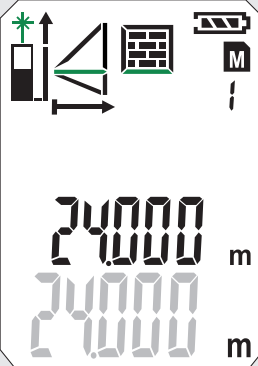

ИЗМЕРЕНИЕ ПЛОЩАДИ СТЕНЫ (СЦЕНАРИЙ 1)

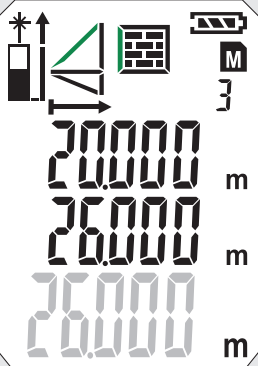
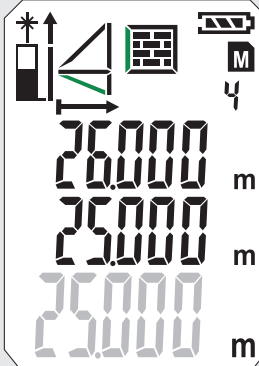
0 	1 	2 	3 	4 
				

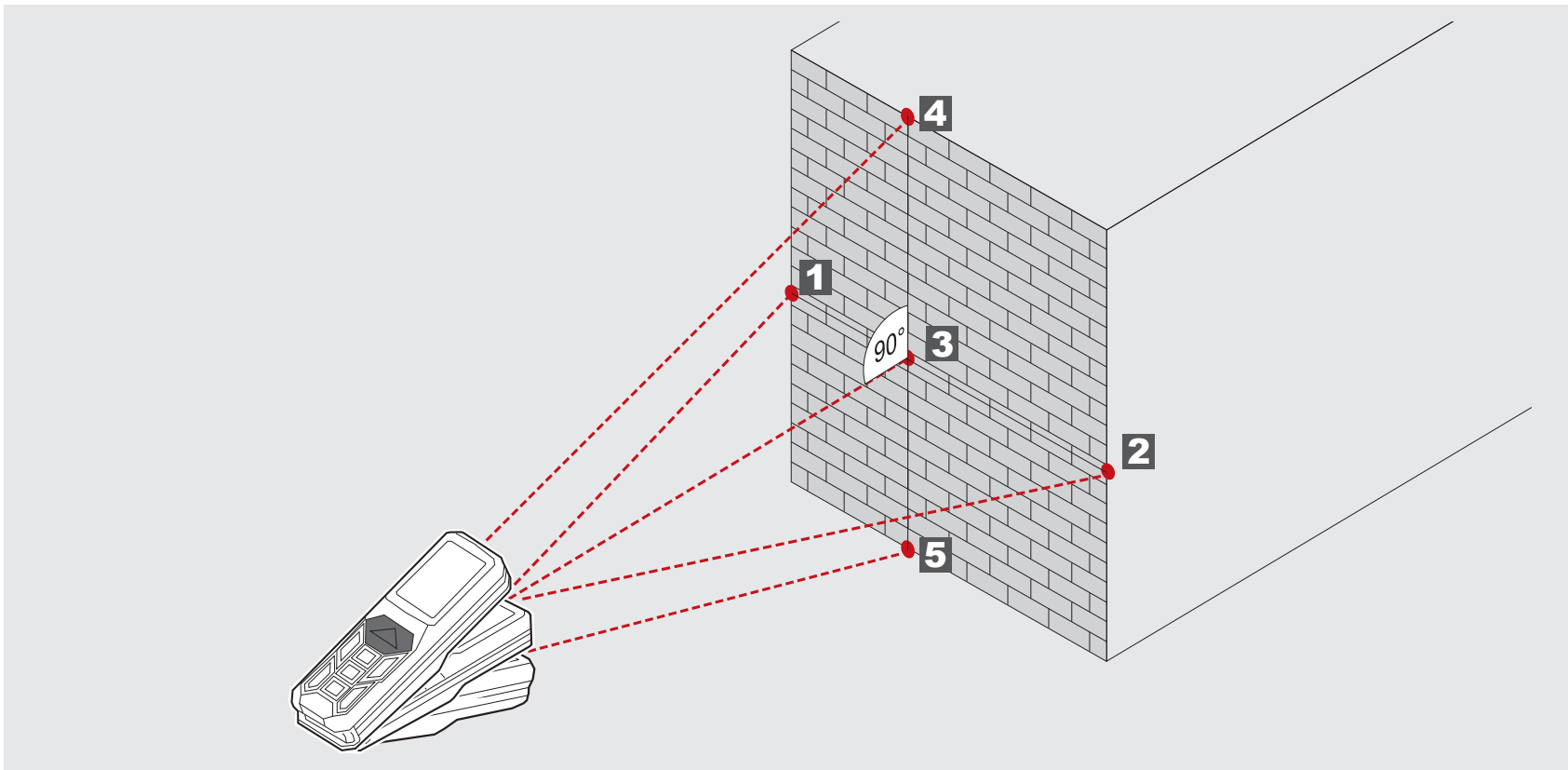



5

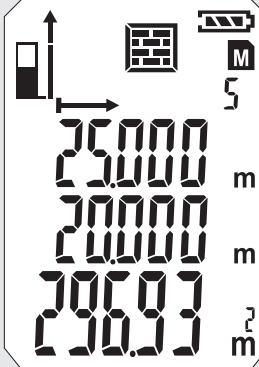

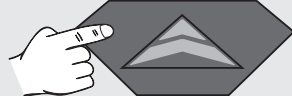
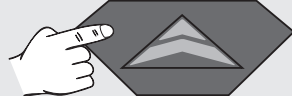
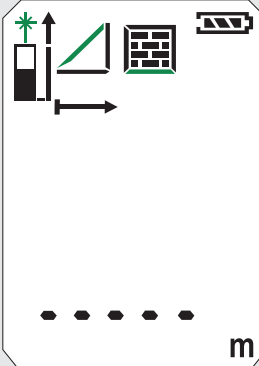
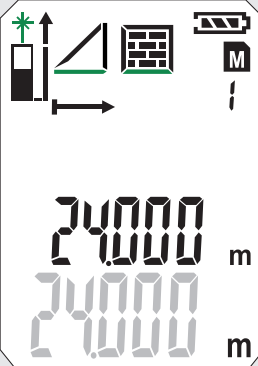
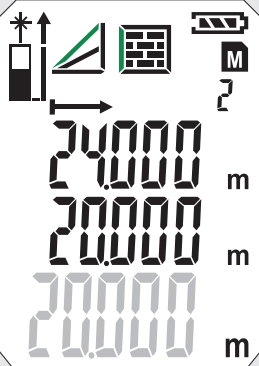
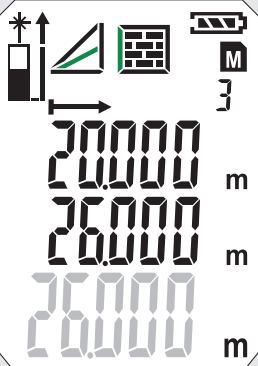
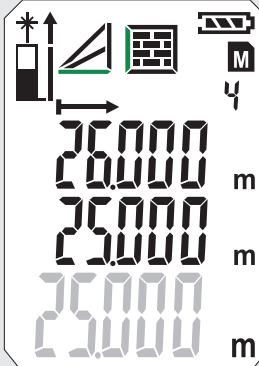

ИЗМЕРЕНИЕ ПЛОЩАДИ СТЕНЫ (СЦЕНАРИЙ 2)

0 	1 	2 	3 	4 
				

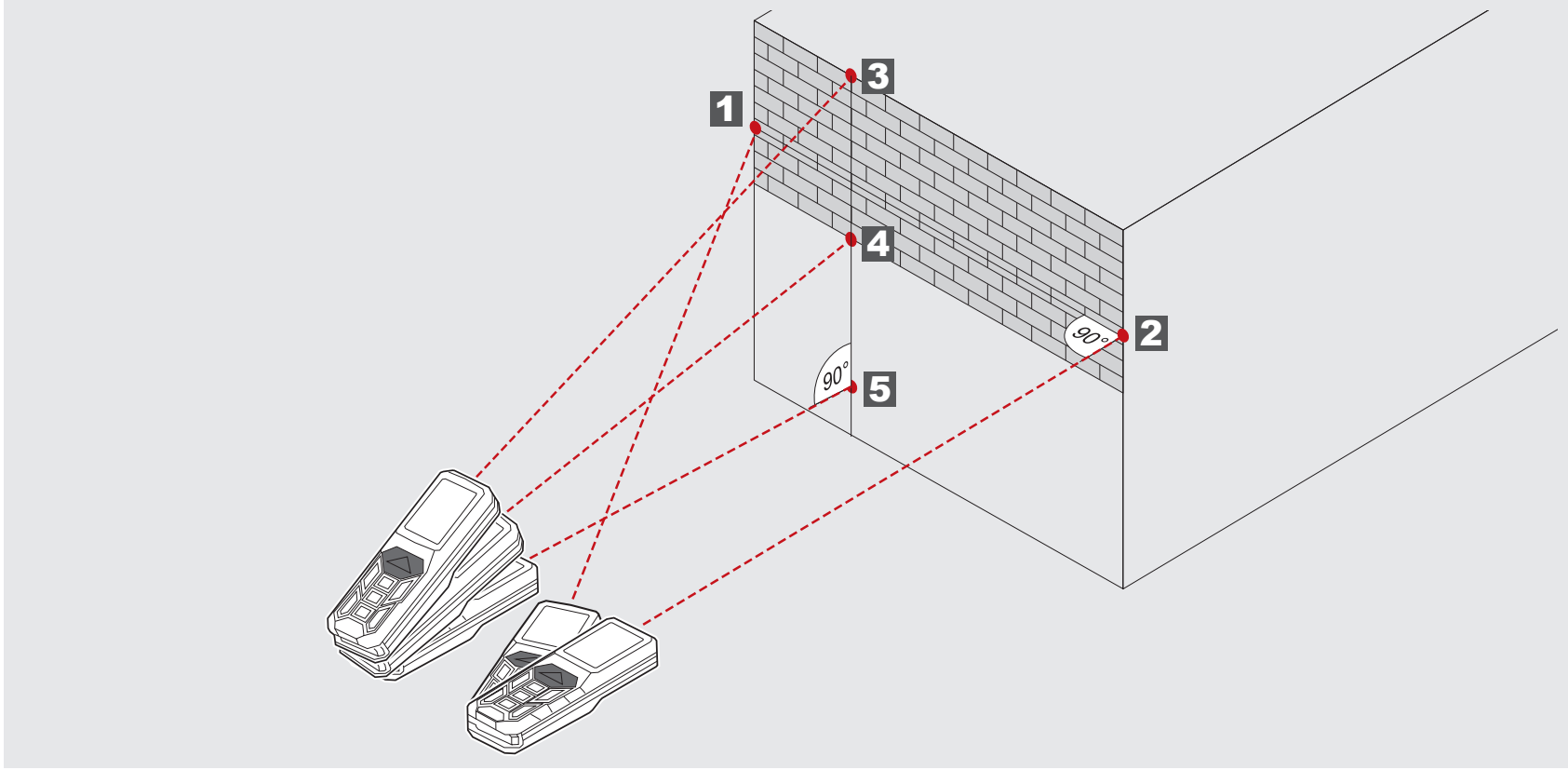

5



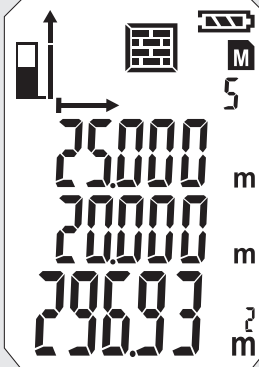



ТАЙМЕР

С помощью таймера можно включить измерение с отсрочкой, например, для расположения компонента в измерительном пучке.

Нажать кнопку 

- Появится символ 
- При нажатии кнопки  можно выставить таймер от 3 до 15 секунд.

Нажать кнопку 

- Идет обратный отсчет секунд до измерения.
- Измерение начинается при значении 0.

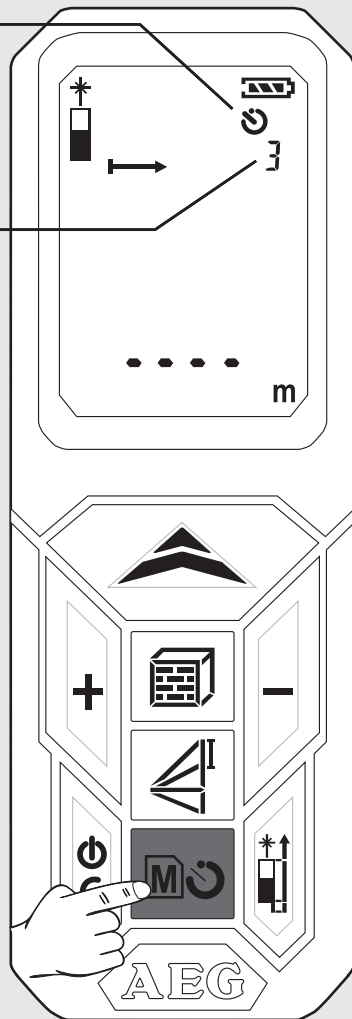

ПАМЯТЬ

Значения измерения автоматически сохраняются в памяти.

Сохраненные значения можно вызвать с помощью кнопки .

Нажать кнопку  на 2 с

- Появится символ и место хранения.
- Отобразится соответствующее значение измерения.
- Сохраненное значение отображается в основной строке.
- Навигация с помощью кнопок +/-

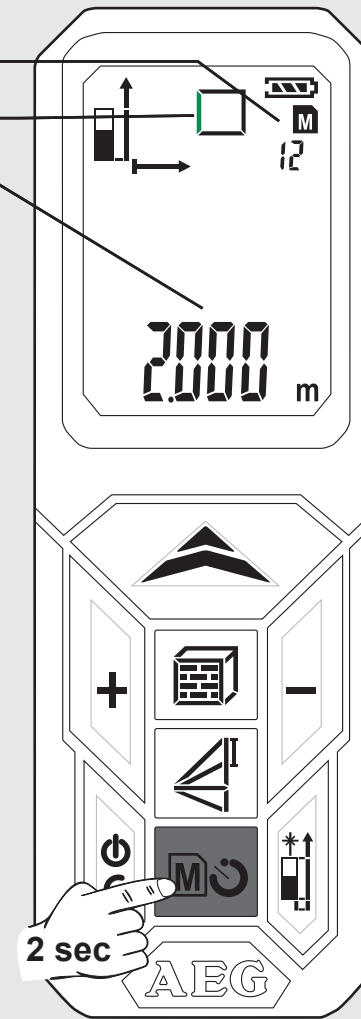

ОСНОВНОЙ ПРИНЦИП ДЕЙСТВИЯ НА ПРИМЕРЕ ИЗМЕРЕНИЯ ПЛОЩАДИ (1)

1 Включение

Нажать кнопку .



⚠ Внимание! Лазерный луч включен!

Не направлять на людей!

Мигает символ лазера (мигание показано зеленым).

2 Выбор плоскости измерения

Стандартная установка после включения: сзади

-  Нажать 1 раз -> угловой штифт
-  Нажать 2 раза -> спереди
-  Нажать 3 раза -> сзади

Отображается символ

3 Выбор функции

После включения прибор всегда установлен на измерение длины.

-  Нажать 1 раз - измерение площади

- Появится символ
- Значение измерения мигает (мигание показано зеленым)

4 Измерение длины

Вывернуть прибор и нажать кнопку .

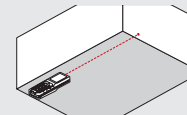

- Ненадолго появится значение измерения в основной строке.
- Через 1 с значение измерения переместится на строку вверх.
- Значение измерения сохраняется в памяти под порядковым номером.
- Мигает второе значение измерения. Прибор готов к измерению второго значения.

5 Измерение ширины

Вывернуть прибор и нажать кнопку .

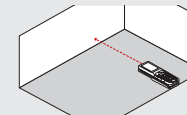

- Ненадолго появится значение измерения в основной строке.
- Через 1 с значение измерения переместится на строку вверх.
- Значение измерения сохраняется в памяти под порядковым номером.
- Результат отображается в основной строке и сохраняется в памяти под порядковым номером.

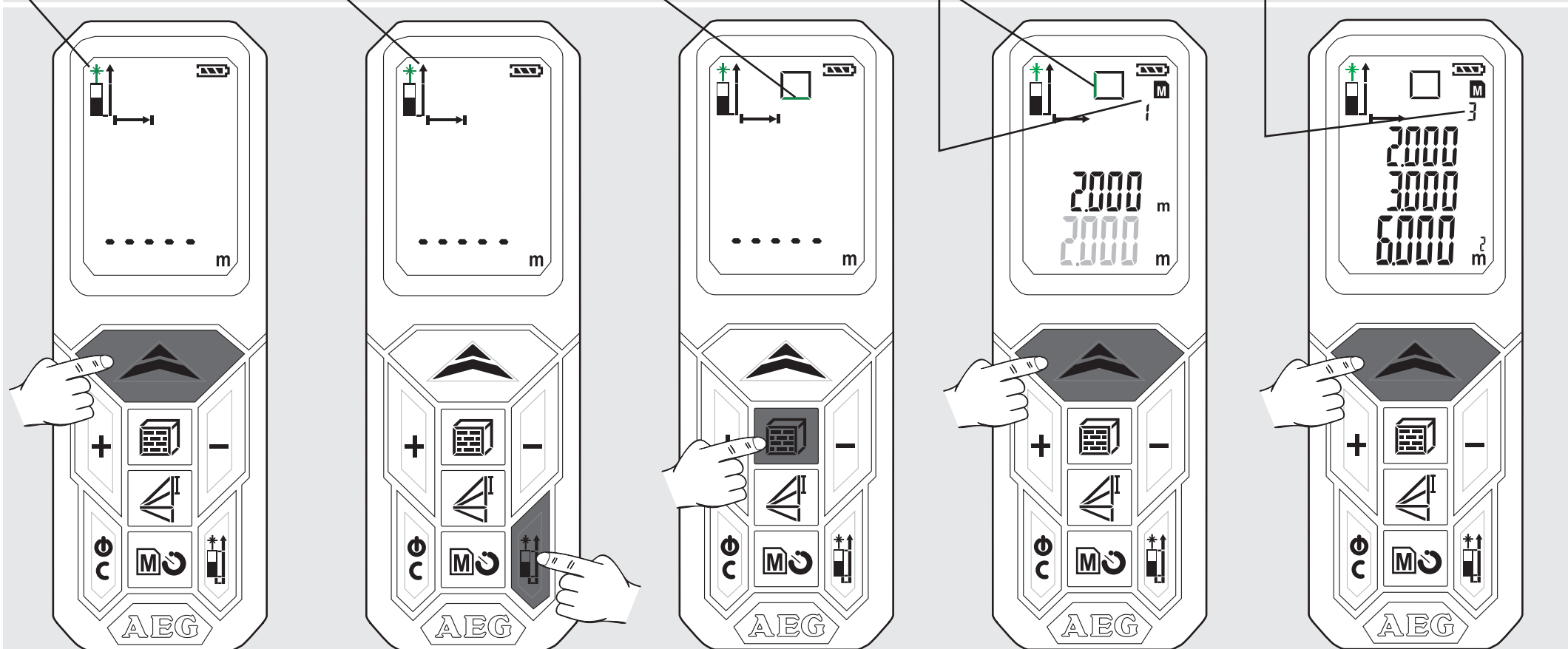

ОСНОВНОЙ ПРИНЦИП ДЕЙСТВИЯ НА ПРИМЕРЕ ИЗМЕРЕНИЯ ПЛОЩАДИ (2)

6 Вызов сохраненных значений

Нажать кнопку  на 2 с.

Нажать кнопку + или -

7 Выход из памяти

Нажать кнопку 

8 Выключение

Нажать кнопку  на 2 с.
(Заранее необходимо выйти из памяти).

- Сохраненные значения отображаются в основной строке.
- Отображается соответствующий символ, и мигает значение измерения (мигание показано зеленым).

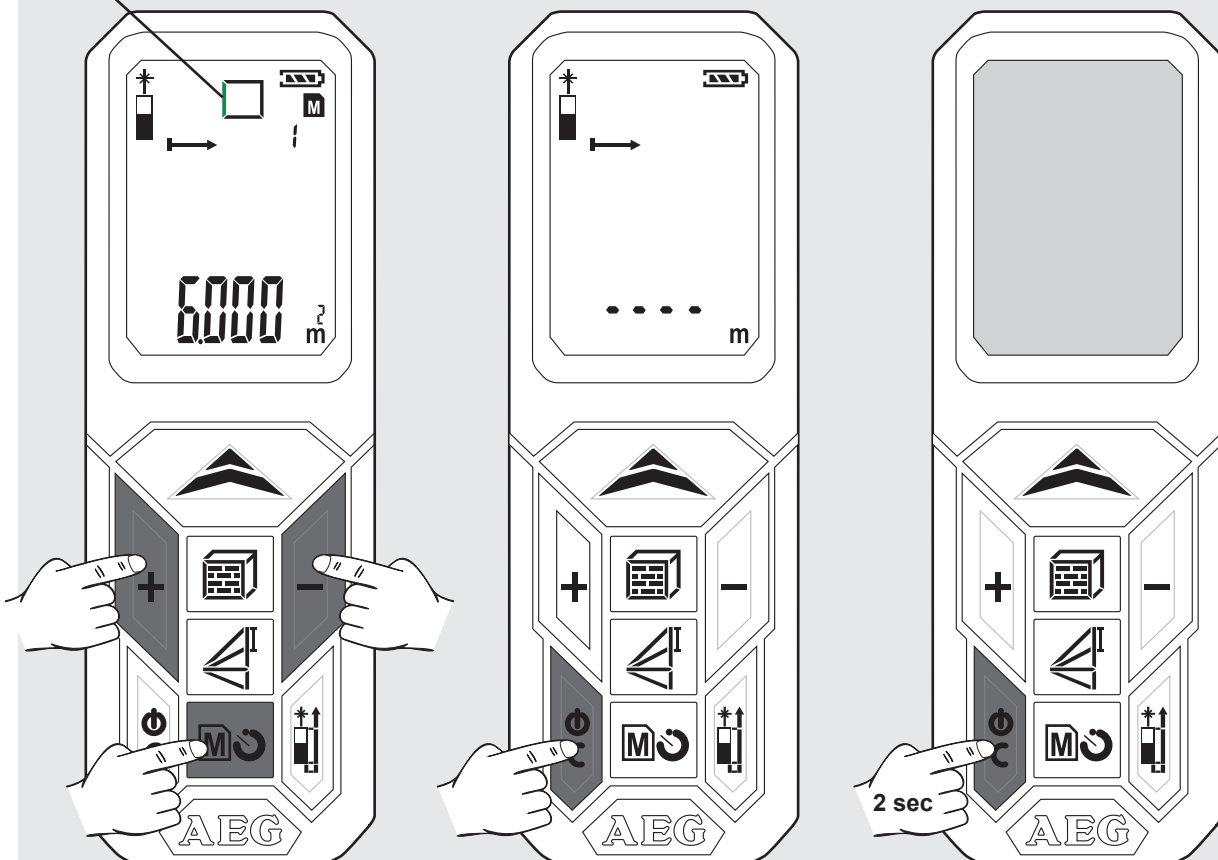

- Прибор выключается.
- Если в течение 3 минут не нажимаются кнопки, прибор автоматически отключается.



СЪДЪРЖАНИЕ

Важни инструкции за безопасност	1
Технически данни	2
Използване по предназначение.....	2
Таблица с кодове за грешки.....	2
Преглед.....	3
Сменете батерията	4
Ъглов щифт	4
Щипка за колан	4
Бутон за функции, Питагор, равнина на измерване.....	5
Единично измерване на дължина	6
Постоянно измерване / минимум-максимум измерване....	7
Измерване чрез събиране / изваждане	8
Измерване на площ	9
Измерване на обем	10
Косвено измерване (Питагор 1).....	11
Косвено измерване (Питагор 2).....	12
Косвено измерване (Питагор 3).....	13
Измерване на стенна повърхност (сценарий 1)	14
Измерване на стенна повърхност (сценарий 2)	15
Таймер	16
Памет	16
Основни операции по примера на измерване на площ (1).....	17
Основни операции по примера на измерване на площ (2).....	18

ВАЖНИ ИНСТРУКЦИИ ЗА БЕЗОПАСНОСТ

  Не използвайте продукта преди да сте проучили Инструкциите за безопасност и Наръчника на потребителя, приложени на компакт диска.

Класификация на лазера

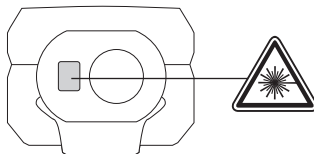

ПРЕДУПРЕЖДЕНИЕ:

Това е лазерен продукт Клас 2, съгласно IEC 60825-1:2007.



Надпис

Преди първото пускане в експлоатация залепете приложената лепенка на Вашия език върху английския текст на табелката с технически характеристики.

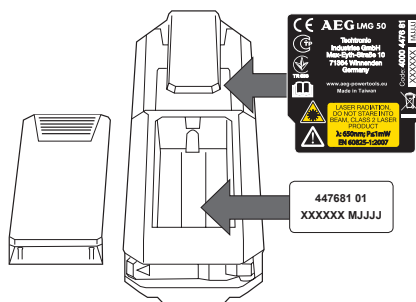

Предупреждение:

Избягвайте директен контакт с очите. Лазерният лъч може да доведе до флаш изгаряне на очите и до временно заслепяване.

Не гледайте в лазерния лъч, нито го насочвайте директно към други хора без това да е необхо- димо.

Не заслепявайте други лица.

Внимание:

Не работете с лазерния уред в непосредствена близост до деца и не им позволявайте да го използват.

Внимание! Рефлектиращи повърхности могат да рефлектират лазерния лъч обратно към оператора или към други лица.

Спазвайте безопасна дистанция от движещи се части.

Периодично провеждайте тестови измервания. Точно пред, по време на и след важни измервания.

Внимавайте за неправилни измервания, ако продуктът е дефектен или ако е бил изпускан, неправилно използван или модифициран.

Внимание! Запознайте се добре с обслужващите елементи и начинът на работа с Вашия градински електроинструмент.

Лазерният уред за измерване има ограничен обхват (виж раздел "технически характеристики"). Опити за измерване извън максималния и минималния обхват водят до неточности. Употребата при неблагоприятни условия като твърде горещо, твърде студено, много ярка слънчева светлина, дъжд, сняг, мъгла или други ограничаващи видимостта условия може да доведе до неточни измервания.

Ако премествате лазерния уред за измерване от топло на студено (или обратно), изчакайте, докато уредът се адаптира към новата околна температура.

Винаги съхранявайте лазерния уред за измерване на закрито, предпазвайте го от удар, вибрации или екстремни температури.

Предпазвайте лазерния уред за измерване от прах, вода и висока влажност на въздуха. Такива могат да унищожат вътрешни компоненти или да повлияят на точността на измерване.

Не използвайте агресивни почистващи препарати или разтворители. Почиствайте само с чиста, мека кърпа.

Избягвайте силни удари по лазерния уред за измерване или изпускане на същия. Точността на уреда трябва да бъде проверена след изпускане или излагане на други механични натоварвания.

Необходими ремонти на този лазерен уред трябва да бъдат извършвани само от оторизиран сервизен персонал.

Не работете с продукта в опасни участъци или във враждебна среда.

Използвайте само зарядните устройства, препоръчани от производителя, за да заредите батериите.



Изтощени батерии не трябва да се изхвърлят заедно с битови отпадъци. Грижете се за околната среда и ги давайте в пунктове за събиране, съгласно националното и местно законодателство. Продуктът не трябва да се изхвърля заедно с битови отпадъци.

Изхвърляйте продукта по начин, който е в съответствие с валидните за вашата страна националните разпоредби в тази връзка. Спазвайте специфичното национално и местно законодателство. Обърнете се към местните власти или към Вашия търговец за повече информация относно изхвърлянето.



ТЕХНИЧЕСКИ ДАННИ

Клас на защита	IP54 (защита от прах и вода)
Оптичен компонент	14 мм
Фокус	35 мм
Максимален обхват на измерване	50 метра (допуск: 55м)
Минимален обхват на измерване	0,05 метра
Абсолютна точност @ < 10м	± 1,5 мм (макс.)
Повторяема точност @ < 10м	± 1,5 мм (типична макс. 2σ)
Повторяема точност @ > 10м	повишение ± 0,25 мм / метър (типична макс. 2σ)
Време на измерване	0,5 сек.
Дисплей тип	LCD (22,7 мм x 31 мм)
Електрозахранване	AAA 2x (алкална батерия)
Капацитет на батерията	10000 (единични измервания)
Изходна мощност на лазера	0,6 mW ~ 0,95 mW (Клас 2, 650nm)
Размер на лазерната точка	25 x 30 мм @ 16 м (макс.)
Вертикален ъгъл на лазерния лъч	±1 градус
Хоризонтален ъгъл на лазерния лъч	±1 градус
Автоматично изключване на уреда	180 секунди
Автоматично изключване на лазера	30 секунди
Температурен диапазон на работа	-10°C до +50°C
Температурен диапазон на съхранение	-25°C до +70°C
Тегло без батерия	80 гр.

ИЗПОЛЗВАНЕ ПО ПРЕДНАЗНАЧЕНИЕ

Лазерният уред за измерване е подходящ за измерване на разстояния и на наклони. Този уред може да се използва по предназначение само както е посочено.

ТАБЛИЦА С КОДОВЕ ЗА ГРЕШКИ

Код	описание	решение
Грешка01	Извън обхват на измерване	Извършете измерването в предвидения обхват.
Грешка02	Рефлектираният сигнал е твърде слаб	Изберете по-добра повърхност.
Грешка03	Извън обхвата на дисплея (макс. стойност: 99.999), напр. резултатът от площ или обем е извън обхвата на дисплея	Проверете, дали стойностите и стъпките са правилни.
Грешка04	Грешка в Питагоровото изчисление	Проверете, дали стойностите и стъпките са правилни.
Грешка05	Батерията е изтощена	Поставете нова батерия.
Грешка06	Извън температурния диапазон на работа	Извършете измерването в рамките на предвидения температурен диапазон на работа.
Грешка07	Околната светлина е твърде ярка	Загънете целевата зона.

Питагор
Разлика във височината

Равнина на измерване

Измерване на дължина

Минимум / Максимум за постоянно измерване

Събиране / Изваждане

ВКЛ. / ИЗМЕРВАНЕ

- ▶ Вкл.
- ▶ Измерване
- ▶ Постоянно измерване (натиснете за 2 сек.) мин. / макс. функция

СЪБИРАНЕ

- ▶ Добавяне на стойност
- ▶ Навигиране в менюто на паметта

ПЛОЩ / ОБЕМ

- ▶ Площ (натиснете 1x)
- ▶ Обем (натиснете 2x)
- ▶ Косвено измерване на площ (натиснете 3x / 4x)

ВКЛЮЧВАНЕ

- ▶ Вкл.
- ▶ Изкл. (натиснете за 2 сек.)
- ▶ Изтриване

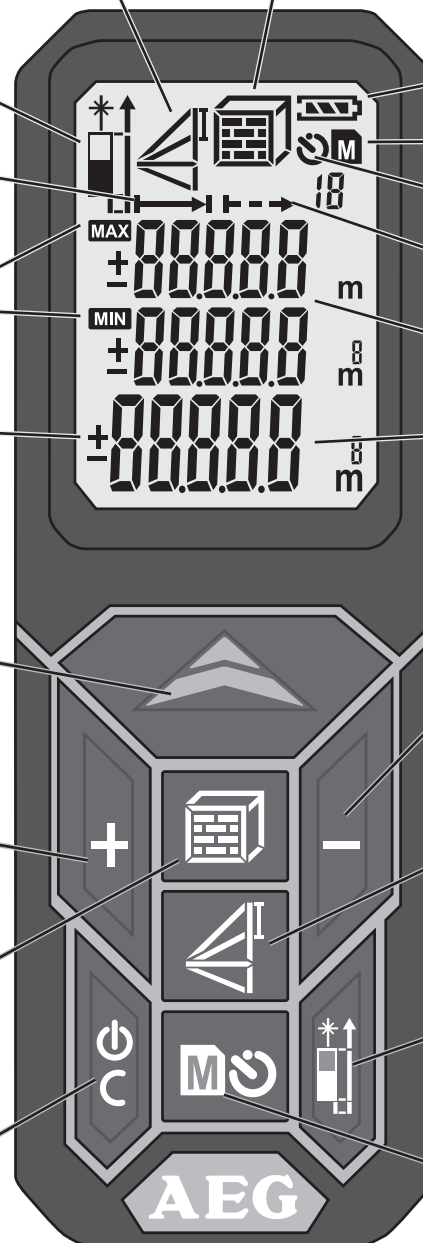

Площ / Обем
Косвено измерване на площ

Състояние на батерията

Памет

Таймер

Постоянно измерване

Междинни стойности

Основна стойност

ИЗВАЖДАНЕ

- ▶ Изваждане на стойност
- ▶ Навигиране в менюто на паметта

ПИТАГОР

- ▶ Питагор 1 (натиснете 1x)
- ▶ Питагор 2 (натиснете 2x)
- ▶ Питагор 3 (натиснете 3x)

ПРОМЯНА НА РАВНИНАТА НА ИЗМЕРВАНЕ

- ▶ Отпред
- ▶ Отзад
- ▶ Ъглов щифт

ПАМЕТ

- ▶ Таймер 3-15 сек. (натиснете 1x)
- ▶ Памет 1-20 (натиснете 1x за 2 сек.)
- ▶ За навигиране в паметта използвайте бутоните +/-

СМЕНЕТЕ БАТЕРИЯТА

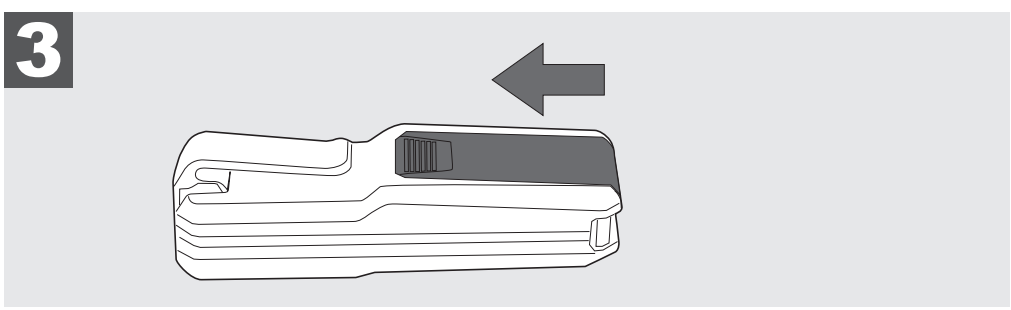
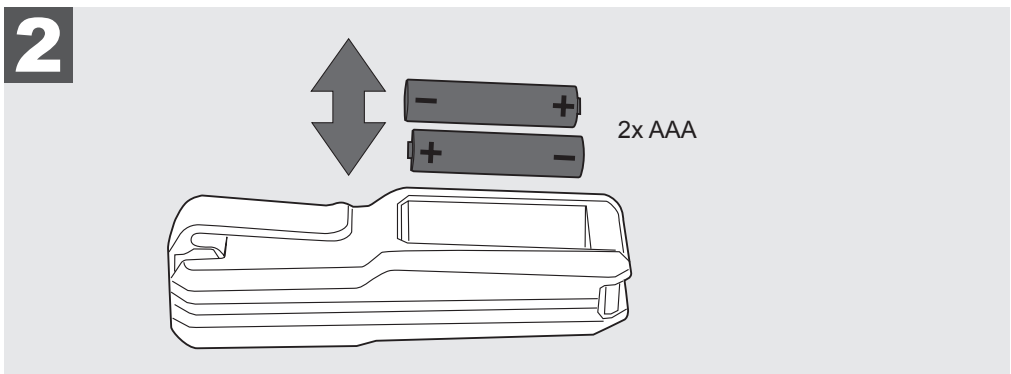
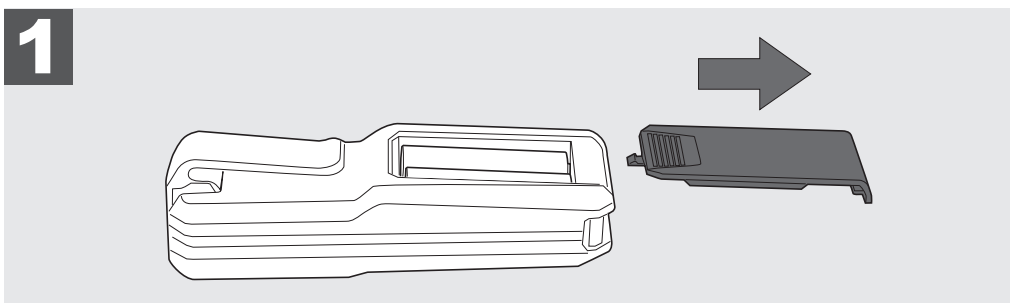
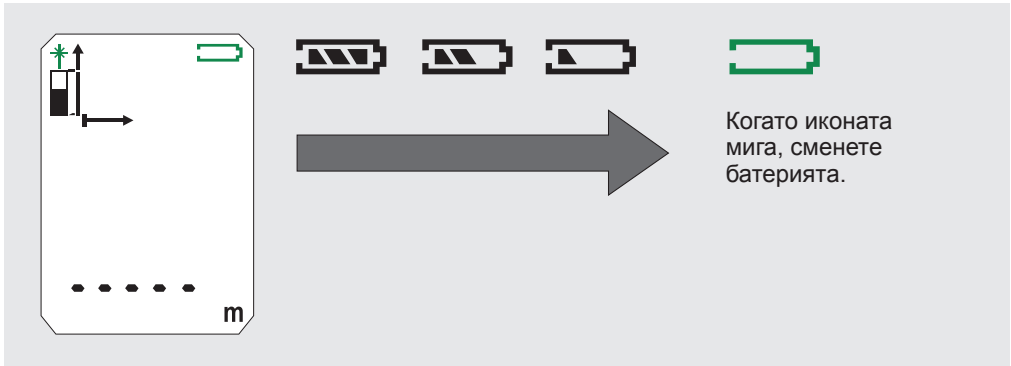

ЪГЛОВ ЩИФТ

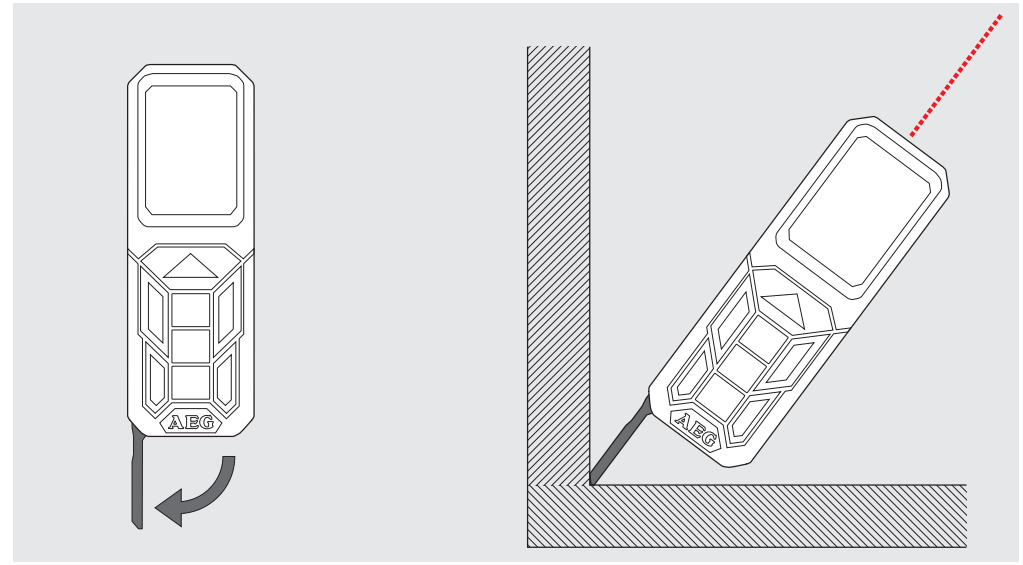

ЩИПКА ЗА КОЛАН

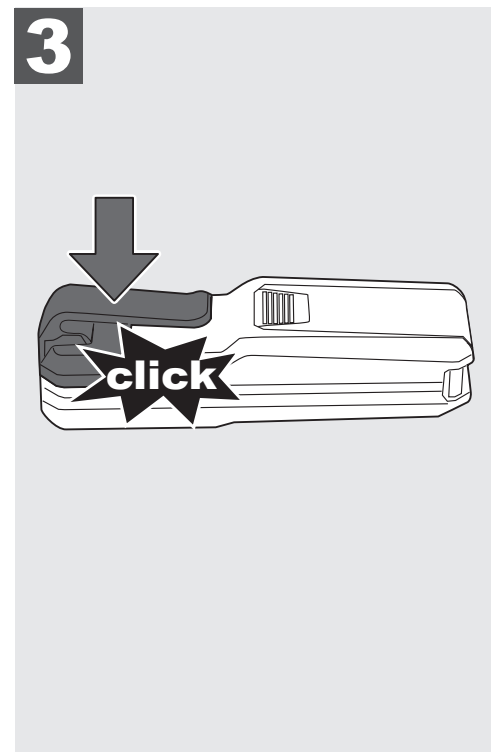
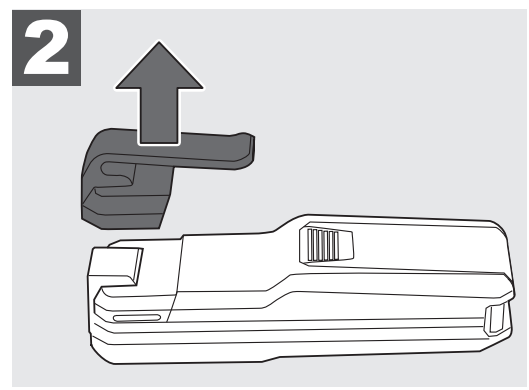
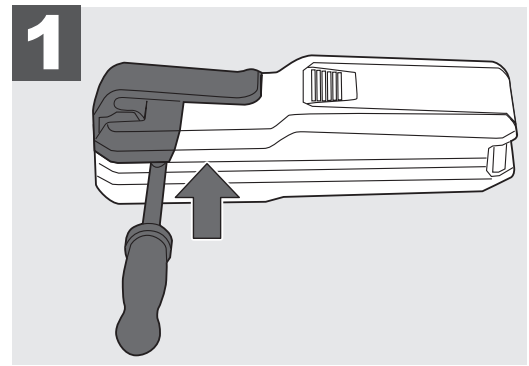

ЕДИНИЧНО ИЗМЕРВАНЕ НА ДЪЛЖИНА

0

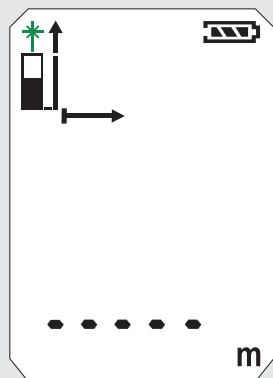

1

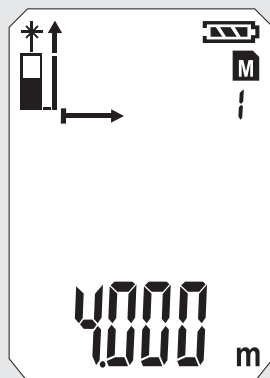
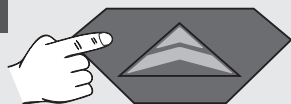

2

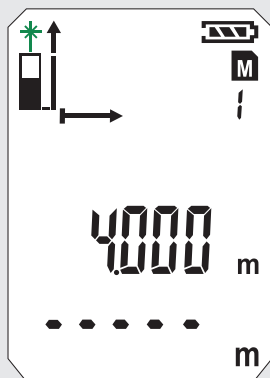
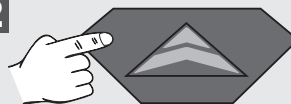

3

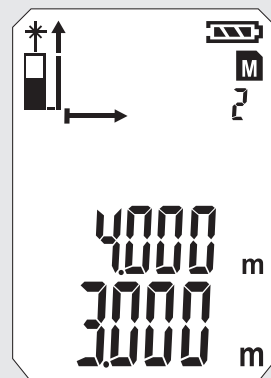
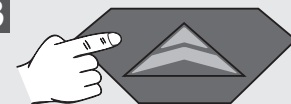

4

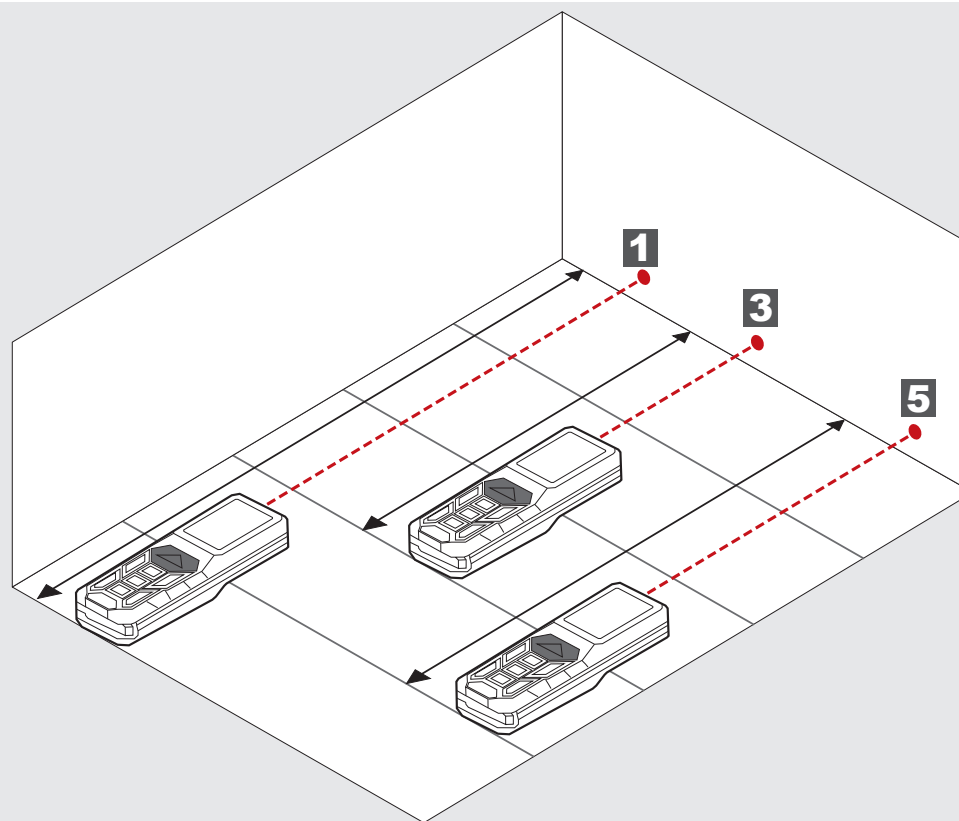
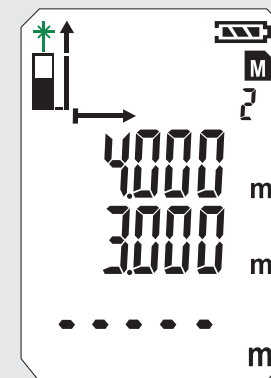
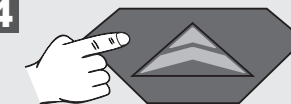

5

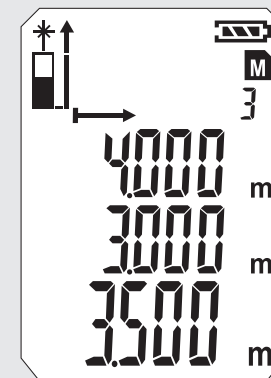
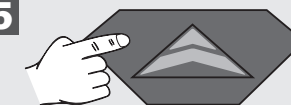

ПОСТОЯННО ИЗМЕРВАНЕ / МИНИМУМ-МАКСИМУМ ИЗМЕРВАНЕ

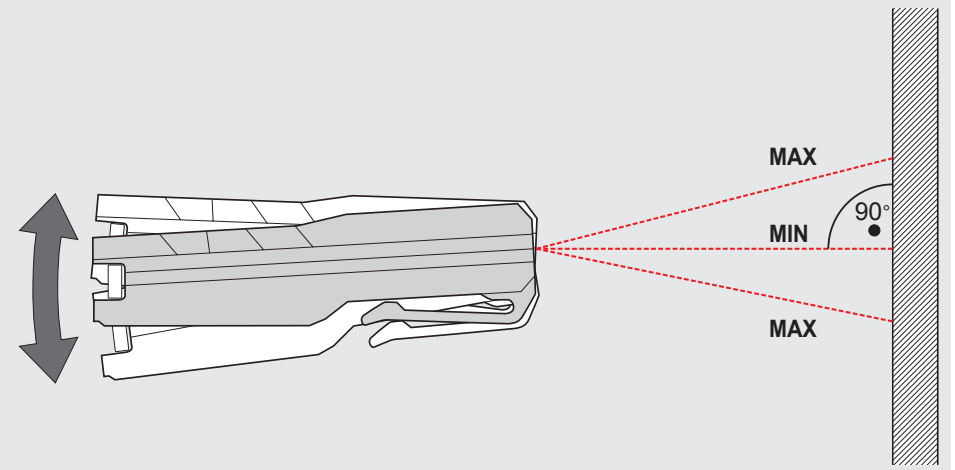
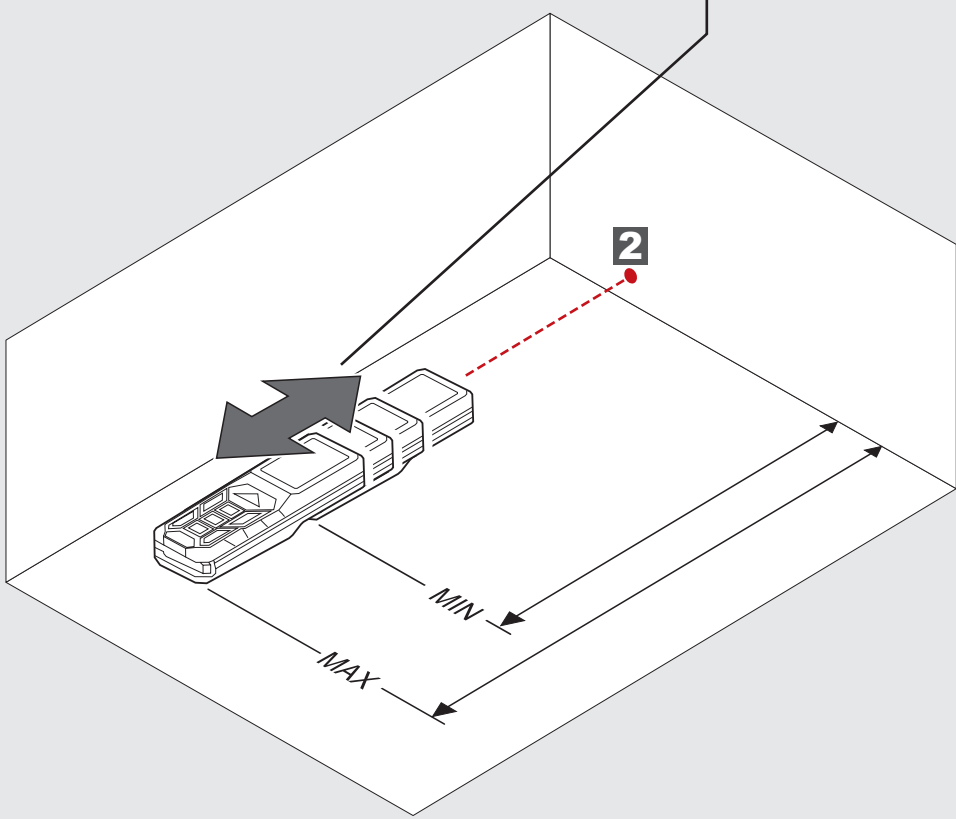
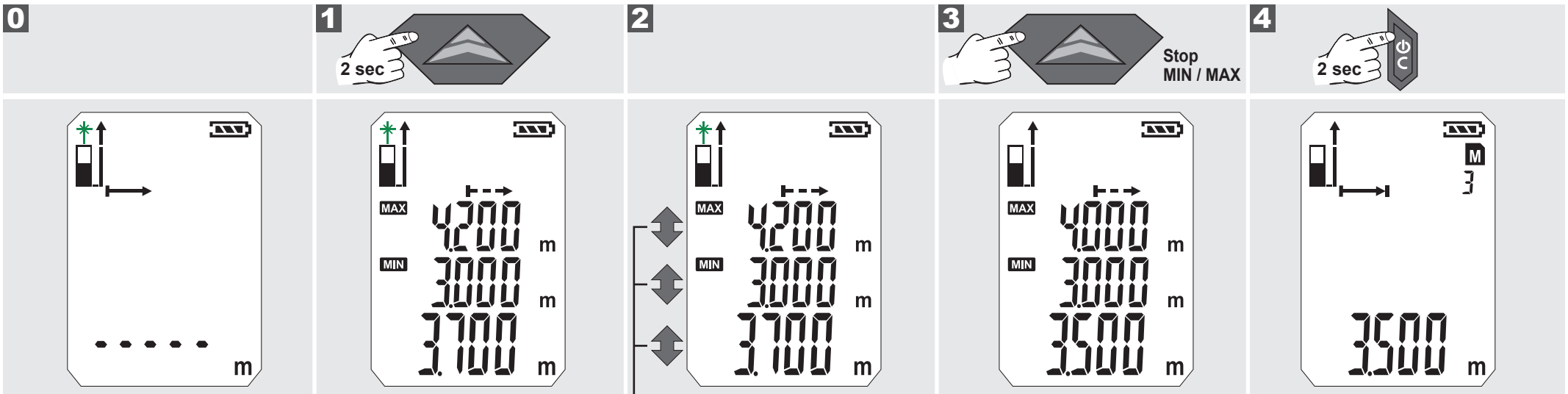

0

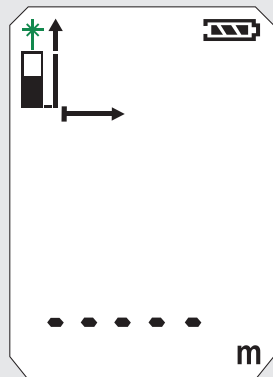

1

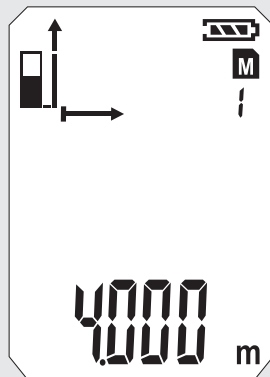
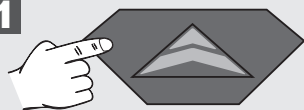

2

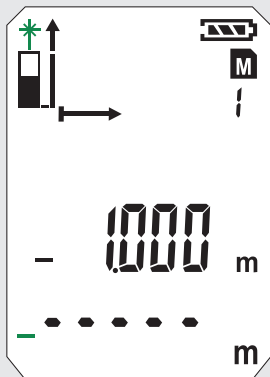
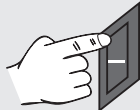

3

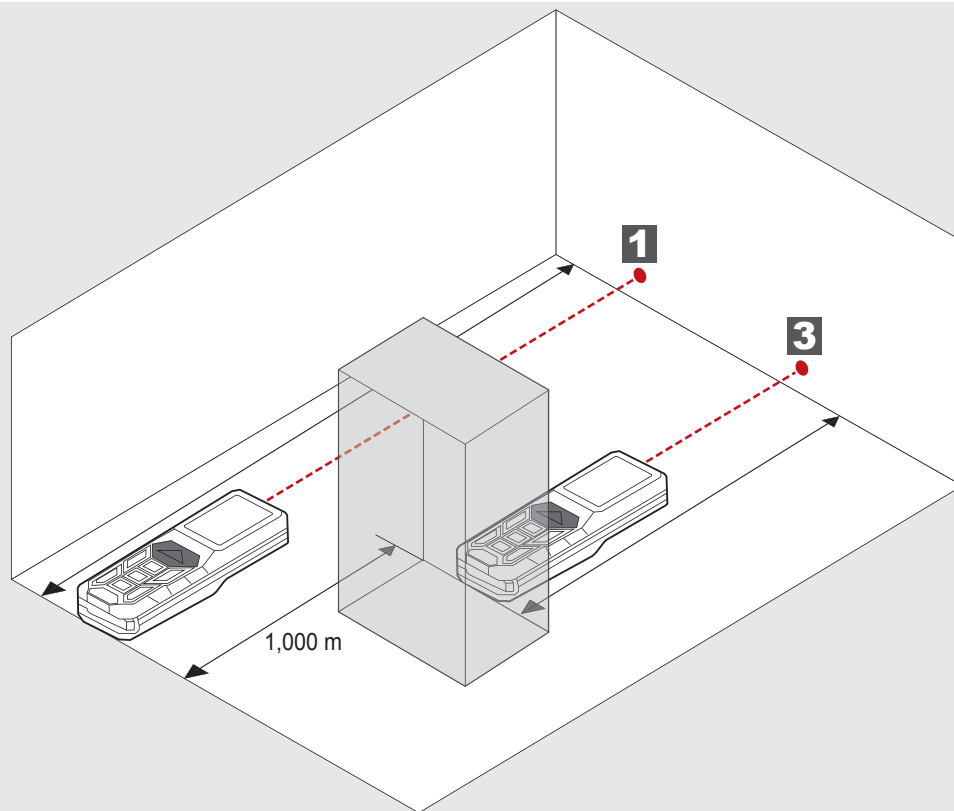
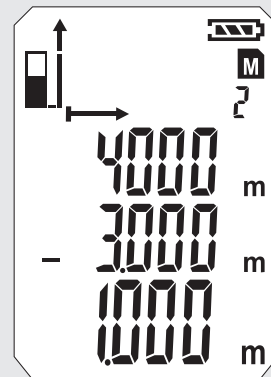
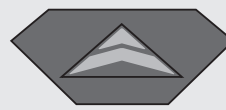

0



1

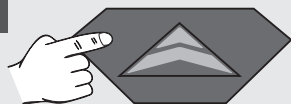

2

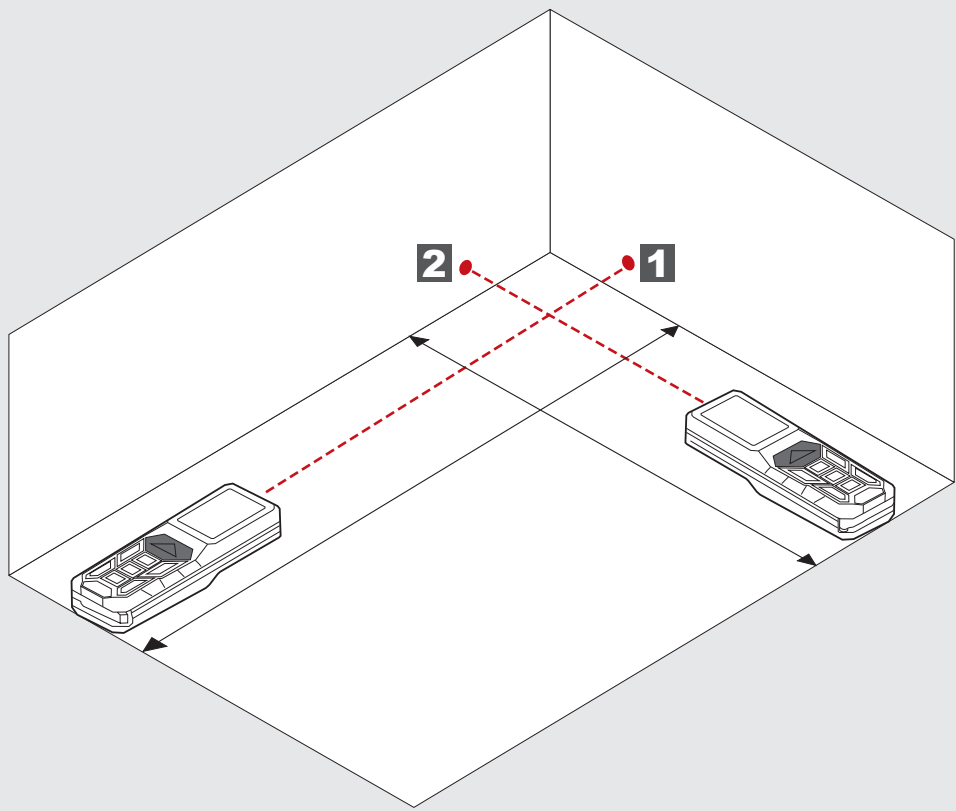
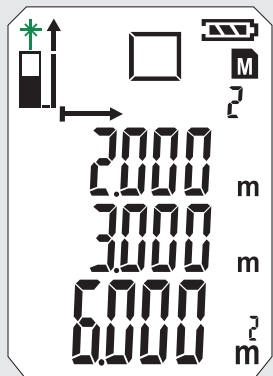
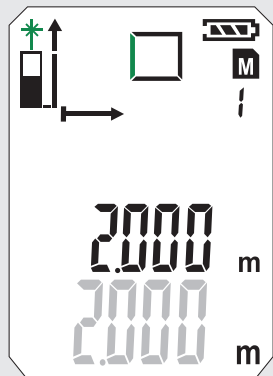
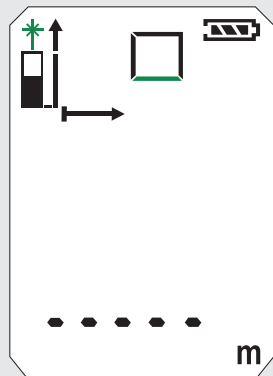
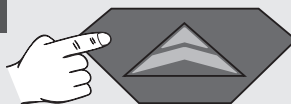

ИЗМЕРВАНЕ НА ОБЕМ

0



1

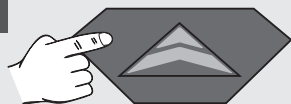

2

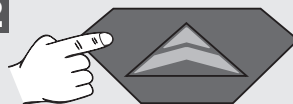

3

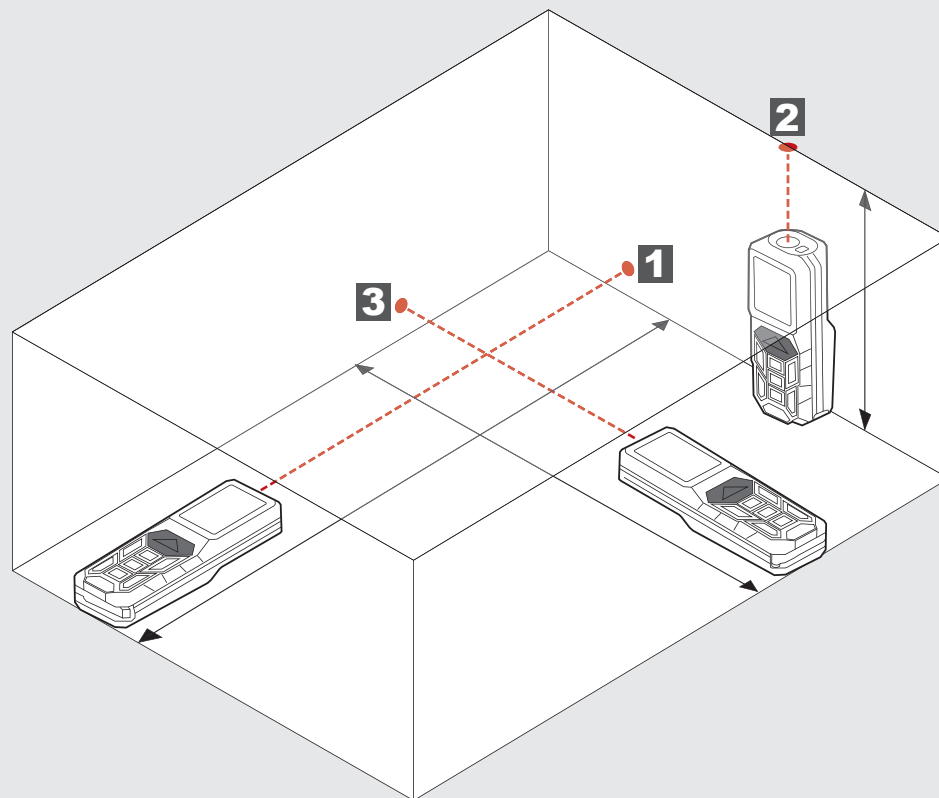
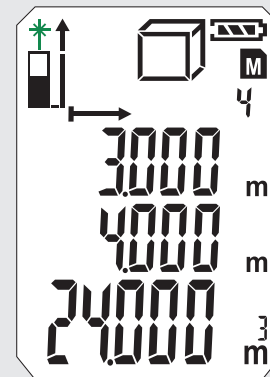
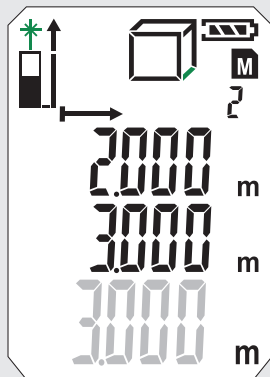
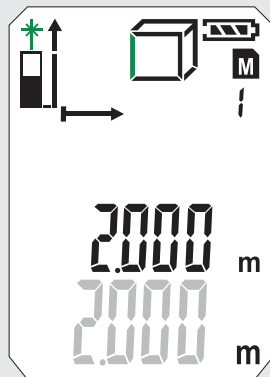
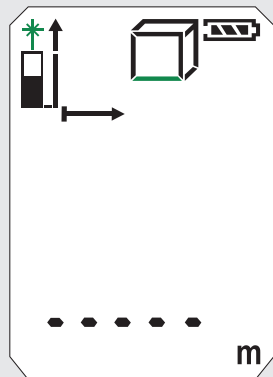
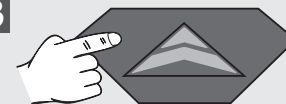

КОСВЕНО ИЗМЕРВАНЕ (ПИТАГОР 1)

0



1

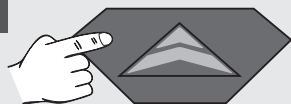

2

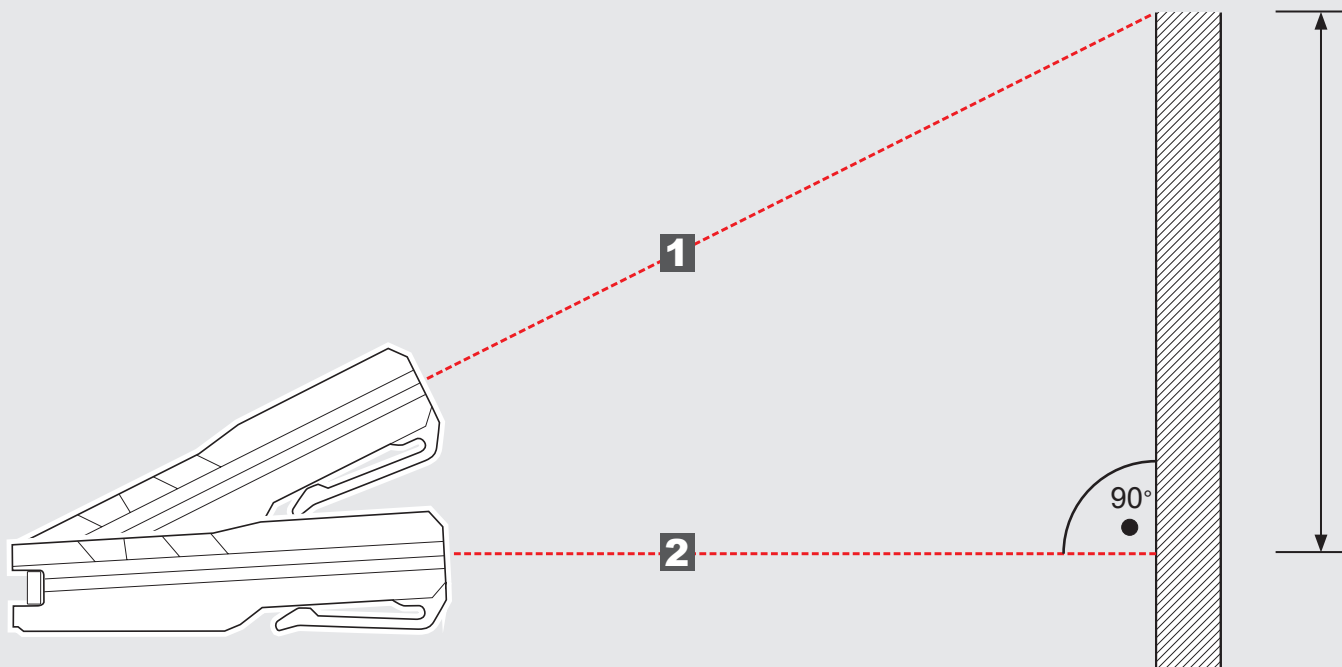
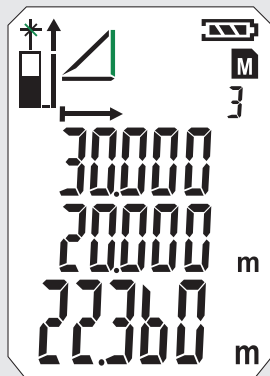
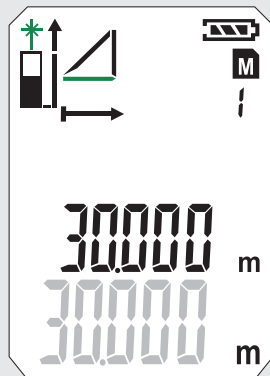
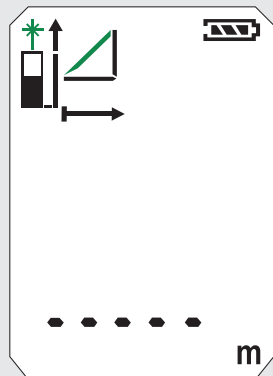
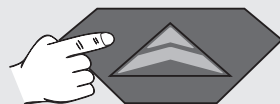

КОСВЕНО ИЗМЕРВАНЕ (ПИТАГОР 2)

0



1

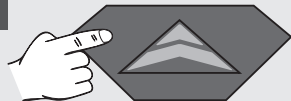

2



3

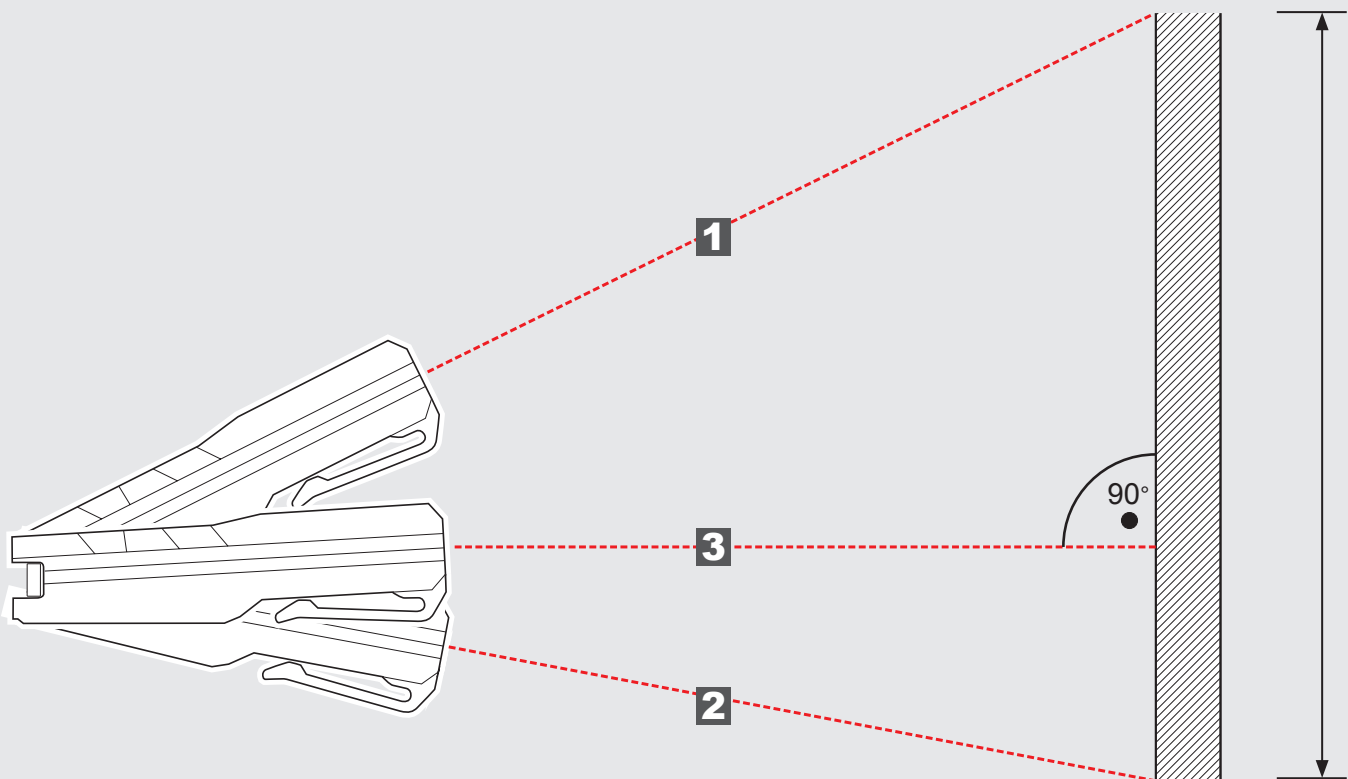
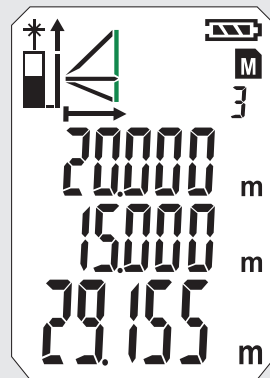
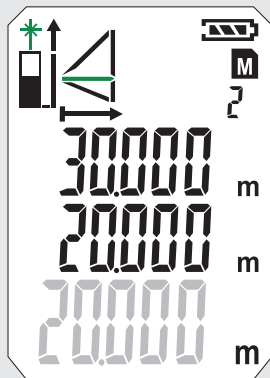
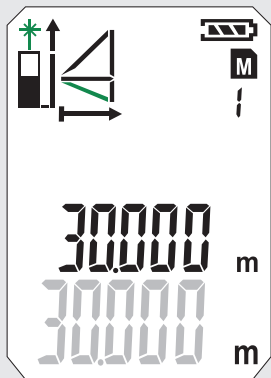
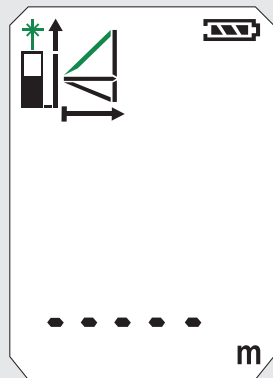

1



2

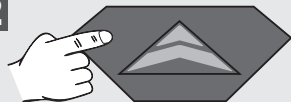



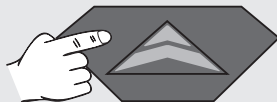



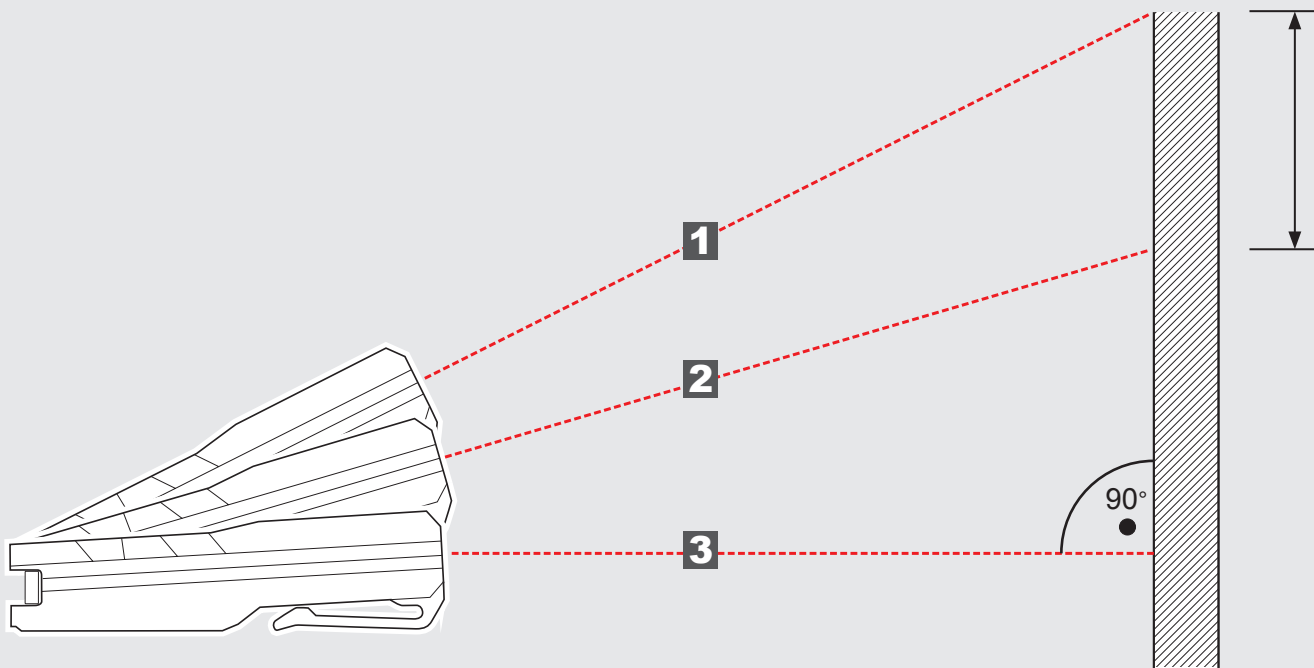
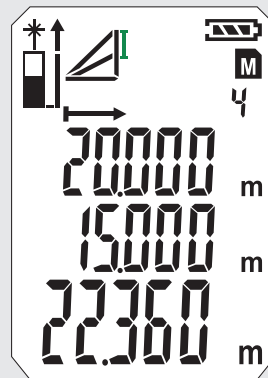
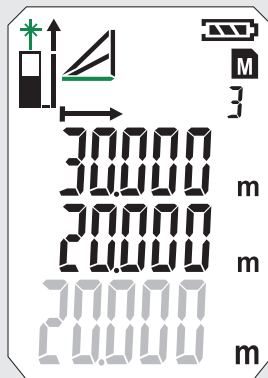
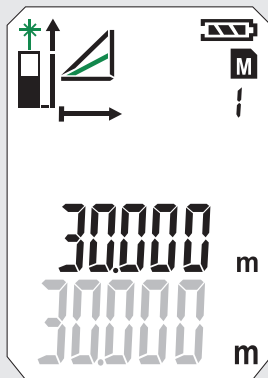
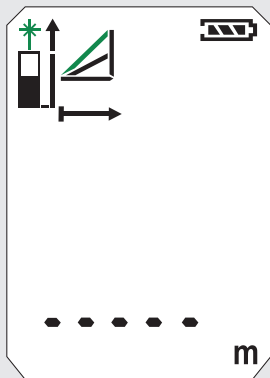







3

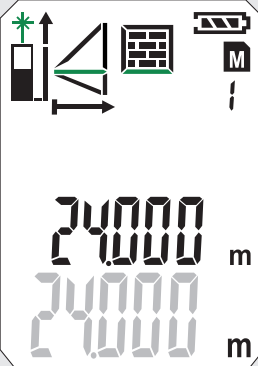

4



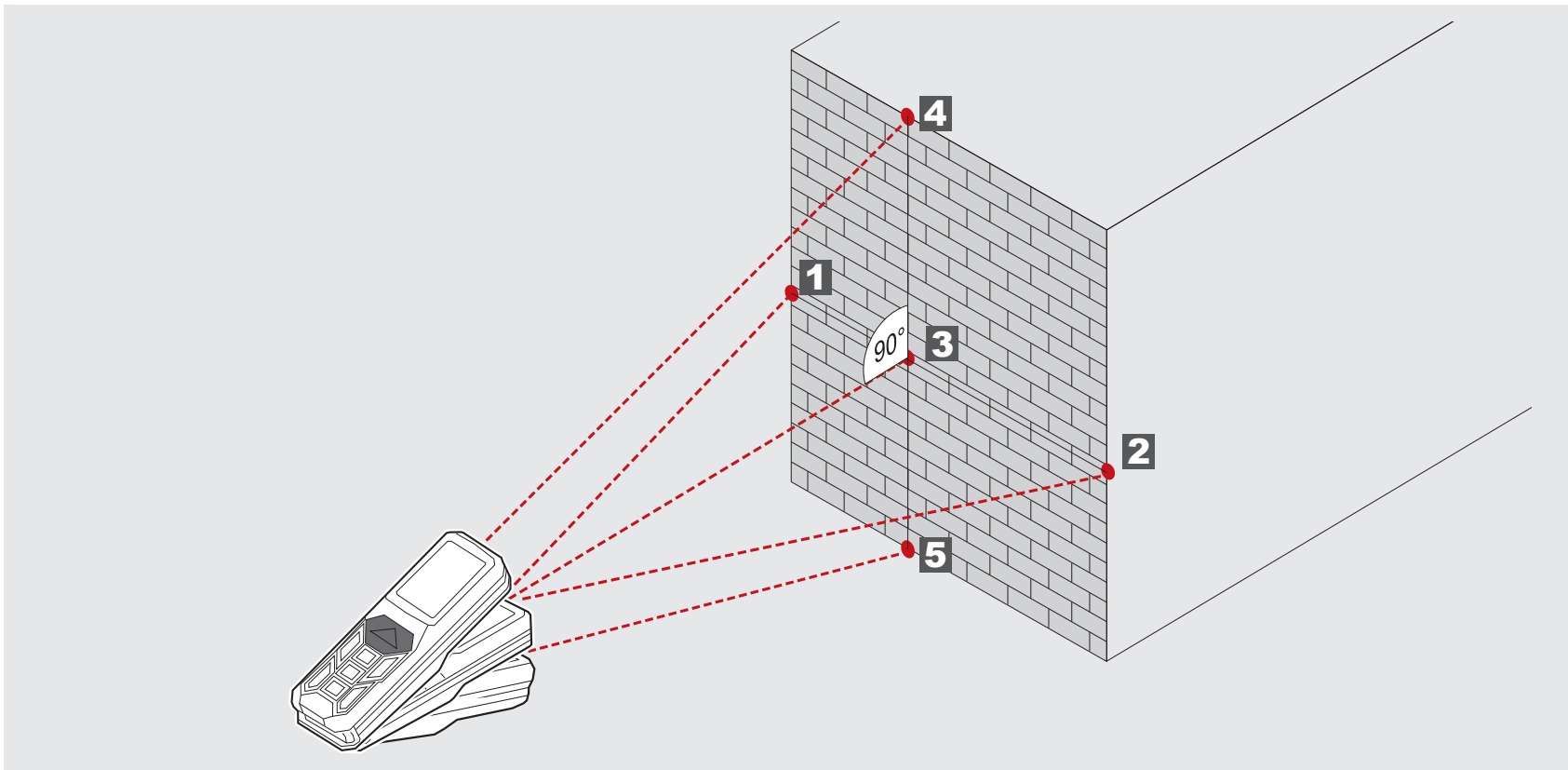

ИЗМЕРВАНЕ НА СТЕННА ПОВЪРХНОСТ (СЦЕНАРИЙ 1)

0 	1 	2 	3 	4 
 	 	 	 	 















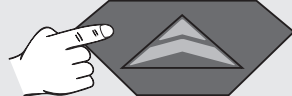
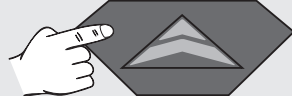

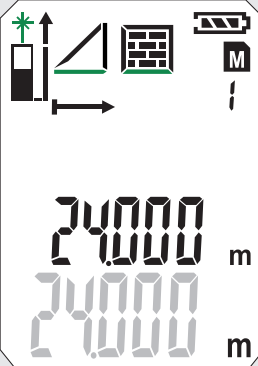





5











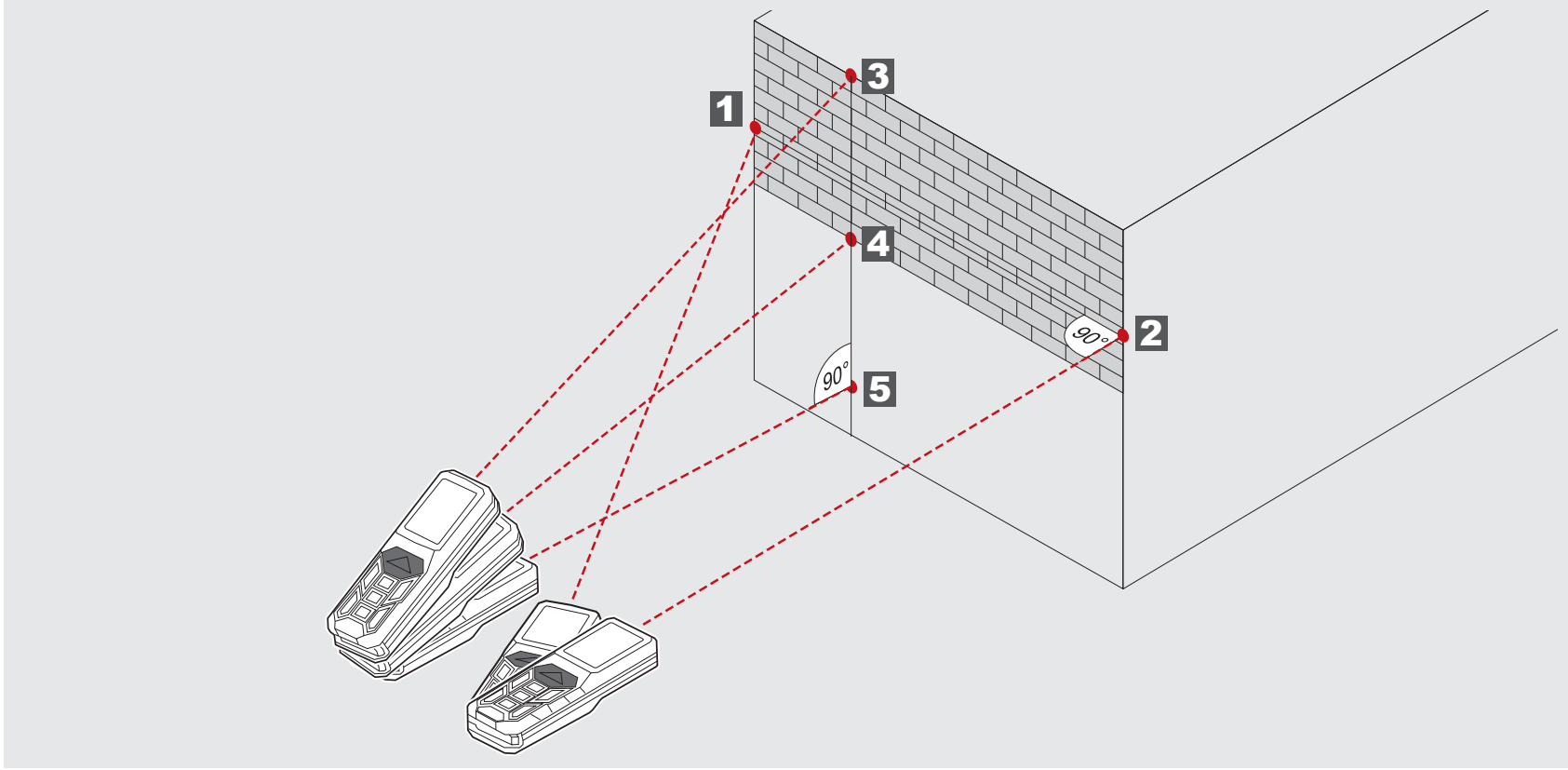

ИЗМЕРВАНЕ НА СТЕННА ПОВЪРХНОСТ (СЦЕНАРИЙ 2)

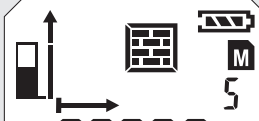
0 	1 	2 	3 	4 
 	  	   	   	   



5 
   

ТАЙМЕР

Измерването може да бъде задействано забавено чрез таймера, напр. за да можете да поставите компоненти в измерващия лъч.

Натиснете бутона 

- Появява се икона.

Таймерът може да бъде настроен между 3 и 15 сек. чрез натискане на бутона 

Натиснете бутона 

- Секундите до започване на измерването се броят в обратен ред.

- Измерването започва при 0.

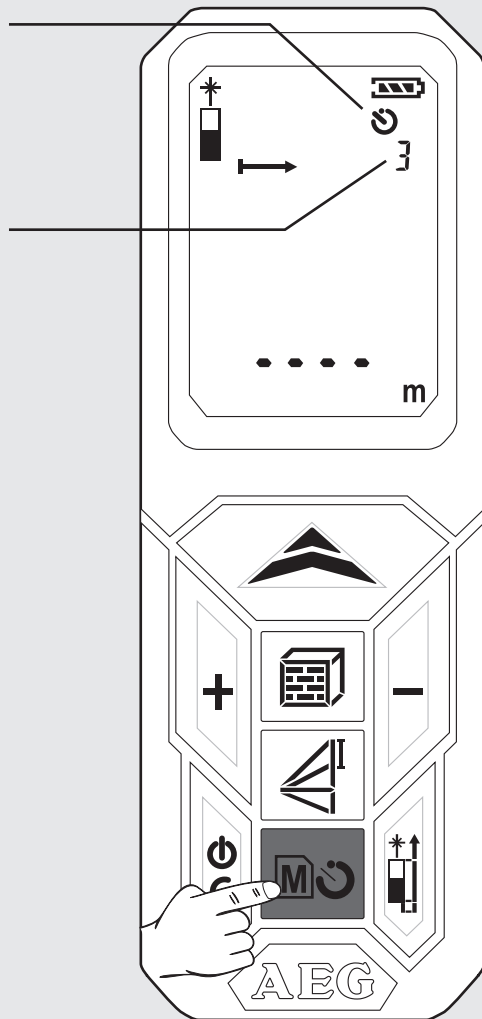

ПАМЕТ

Измерените стойности се запаметяват автоматично и последователно в паметта.

Запаметените стойности могат да бъдат изтеглени чрез бутона 

Натиснете бутона  за 2 сек.

- Появяват се икона и номерът, под който измерването е запаметено.

- Съответният измерен параметър се показва.

- Запаметената стойност се показва на главния ред.

- За навигиране използвайте бутоните +/-

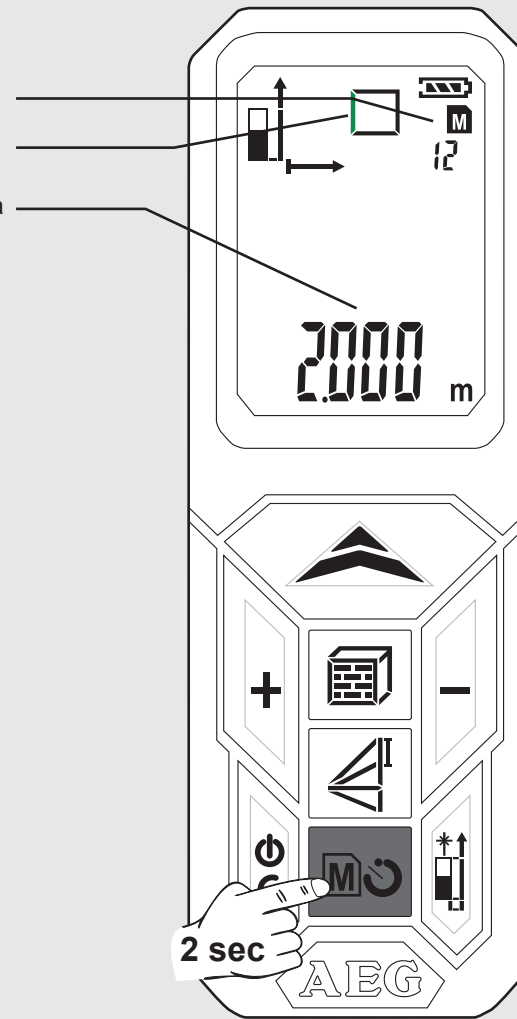

ОСНОВНИ ОПЕРАЦИИ ПО ПРИМЕРА НА ИЗМЕРВАНЕ НА ПЛОЩ (1)

1 Включване



Натиснете бутона .

⚠ Внимание! Лазерът е включен!
Не насочвайте директно към хора!

Иконата на лазера мига (мига в зелено).

2 Избор на равнина на измерване

Настройка по подразбиране след включване: долу

 натиснете 1x -> ъглов щифт
 Натиснете 2x -> горе
Натиснете 3x -> долу

Появява се икона.

3 Избор на функция

След включване уредът е винаги нагласен за измерване на дължина.
Натиснете 1x  - измерване на дължина

- Появява се икона.
- Измереният параметър мига (мига в зелено).

4 Измерване на дължина

Нивелирайте уреда и натиснете бутона .

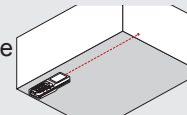

- Измерената стойност се появява за кратко на главния ред.
- Измерената стойност скача след 1 сек. на горния ред.
- Измерената стойност се запазва в паметта под последователен номер.
- Вторият измерен параметър мига. Уредът е готов за измерване на втората стойност.

5 Измерване на ширина

Нивелирайте уреда и натиснете бутона .

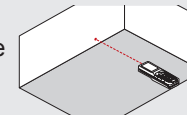

- Измерената стойност се появява за кратко на главния ред.
- Измерената стойност скача след 1 сек. на горния ред.
- Измерената стойност се запазва в паметта под последователен номер.
- Резултатът се показва на главния ред и се запазва в паметта под последователен номер.

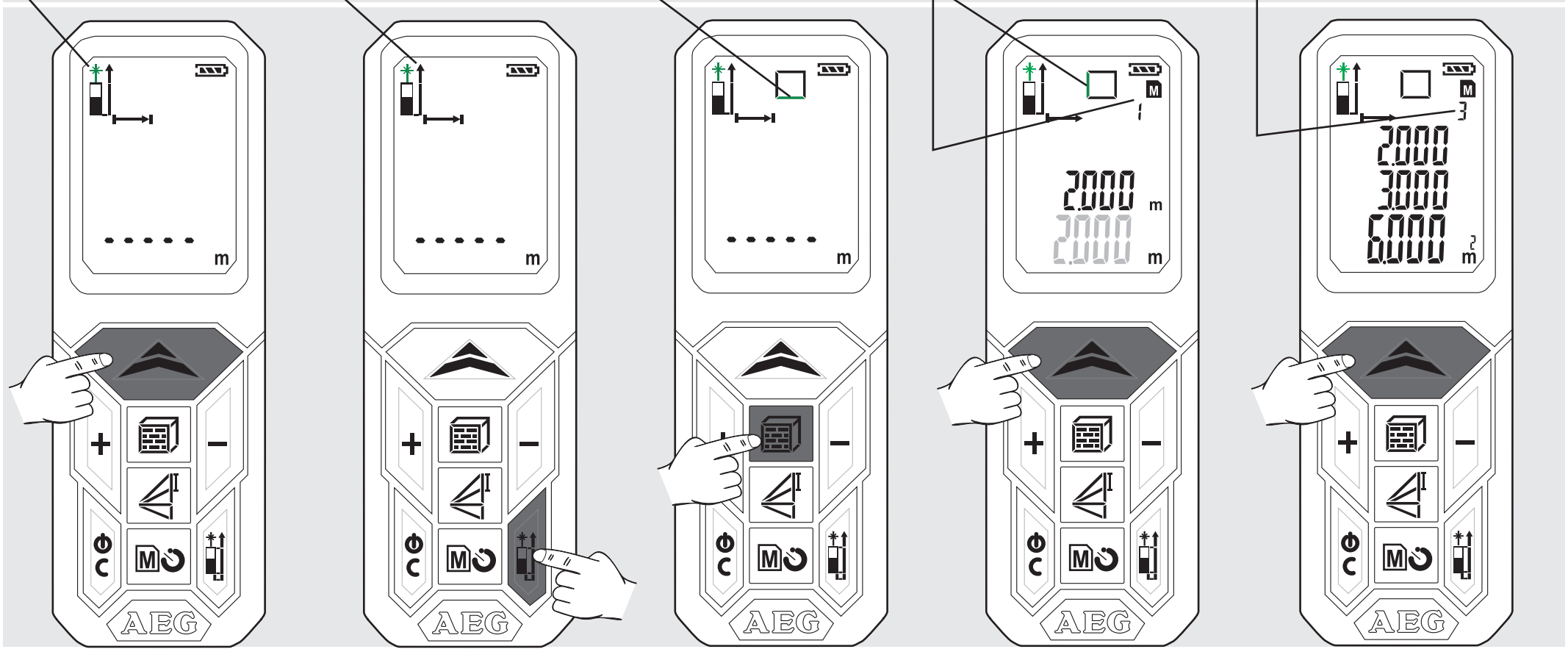

ОСНОВНИ ОПЕРАЦИИ ПО ПРИМЕРА НА ИЗМЕРВАНЕ НА ПЛОЩ (2)

6 Изтегляне на запаменените стойности

Натиснете бутона  за 2 сек.
Натиснете бутона + или -

7 Излизане от паметта

Натиснете бутона 

8 Изключване

Натиснете бутона  за 2 сек.
(трябва да сте излезли от паметта преди това).

- Запаменените стойности се показват на главния ред.

- Съответната икона се показва и измереният параметър мига (мига в зелено).

- Уредът се изключва.

- Ако не бъде натиснат бутон в продължение на 3 минути, уредът се изключва автоматично.

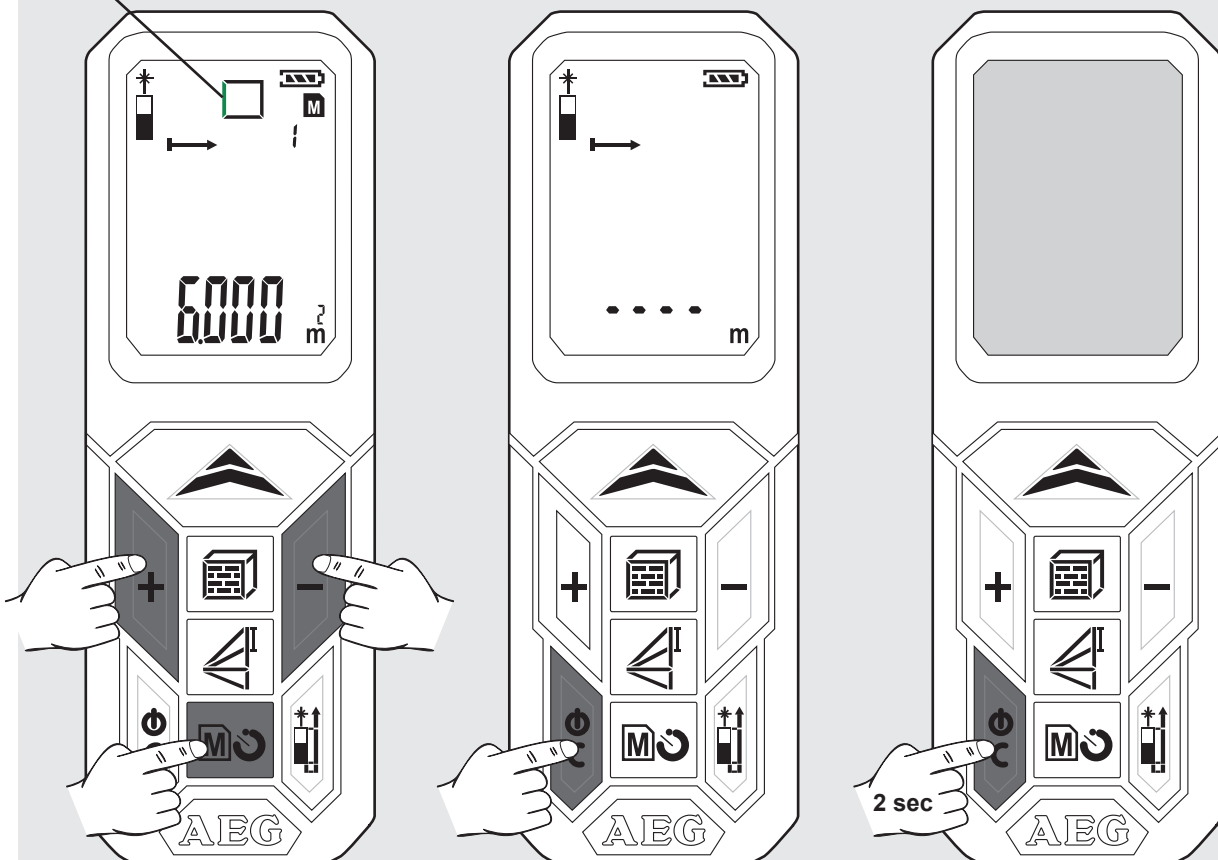

CUPRINS

Importante instrucțiuni de securitate.....	1
Date tehnice	2
Condiții de utilizare specificate	2
Tabel cu codurile de eroare	2
Prezentare	3
Înlocuire baterii	4
Știft colțuri.....	4
Clemă de curea	4
Taste funcționale, Pitagora, nivel de măsurare	5
Măsurare simplă de lungime	6
Măsurare continuă / Măsurare minim-maxim	7
Măsurare cu aditje / scădere	8
Măsurare suprafață	9
Măsurare volum.....	10
Măsurare indirectă (Pitagora 1).....	11
Măsurare indirectă (Pitagora 2).....	12
Măsurare indirectă (Pitagora 3).....	13
Măsurare suprafață perete (scenariu 1).....	14
Măsurare suprafață perete (scenariu 2).....	15
Timer	16
Memoria.....	16
Descrierea de bază pe un exemplu de măsurare a suprafeței (1)	17
Descrierea de bază pe un exemplu de măsurare a suprafeței (2)	18

IMPORTANTE INSTRUCȚIUNI DE SECURITATE



Nu utilizați produsul înainte de a fi studiat instrucțiunile de protecție și Manualul de utilizare din CD-ul anexat.

Clasificare laser

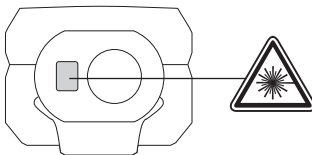

AVERTISMENT:

Acest produs corespunde normelor de securitate pentru lasere de **Categoria 2** IEC 60825-1:2007.



Etichetare

Lipiți eticheta livrată în limba țării dvs., înainte de prima punere în funcțiune, peste textul în engleză de pe tablăta indicatoare a caracteristicilor mașinii.

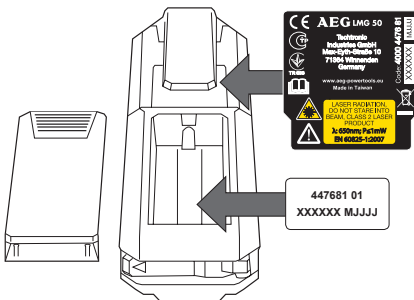

Avertisment:

Evitați să priviți direct. Fasciculul laser vă poate afecta ochii și poate duce la o orbire temporară.

Nu priviți fasciculul laser și nu îl direcționați în mod inutil asupra altor persoane.

Nu-l direcționați în ochii altor persoane.

Avertisment:

Nu activați aparatul cu laser când sunt copii în apropiere și nu le permiteți copiilor să-l folosească.

Atenție! Este posibil ca suprafețe reflectante să redirecționeze fasciculul laser înapoi la operator sau către alte persoane.

Țineți extremitățile la distanță sigură de piesele în mișcare.

Efectuați periodic măsurători de verificare. În mod deosebit înainte de a efectua măsurători importante, în timpul lor sau după ele.

Fiți atent: măsurătorile pot fi eronate, dacă produsul este defect, dacă a fost scăpat din mână, dacă a fost incorect folosit sau modificat.

Atenție! Familiarizați-vă cu elementele de operare și utilizarea reglementară a sculei electrice de grădină.

Aparatul de măsurare cu laser are un domeniu limitat de utilizare. (Vezi Secțiunea "Date tehnice"). Încercările de măsurare în afara domeniului maxim și minim conduc la imprecizie. Utilizarea în condiții neprielnice, cum ar fi de ex. prea cald, prea frig, lumină solară prea puternică, ploaie, zăpadă, ceață sau alte condiții ce limitează vizibilitatea duce la măsurători fără precizie.

Atunci când aparatul de măsurare cu laser este adus dintr-un mediu cald într-un mediu rece (sau invers), așteptați până se adaptează aparatul la noua temperatură a mediului.

Aparatul de măsurare cu laser se păstrează întotdeauna în spații închise, care să-l protejeze de șocuri, vibrații sau temperaturi extreme.

Aparatul de măsurat cu laser se va proteja împotriva prafului, umezelii și umidității ridicate din aer. Acestea pot deteriora componentele din interior sau influența precizia.

Nu folosiți agenți de curățire agresivi și nici solvenți. Se curăță doar cu o cârpă curată și moale.

Evitați loviturile puternice pe aparat sau căderea aparatului. Precizia aparatului ar trebui verificată în cazul în care a căzut sau dacă a fost expus la alte solicitări mecanice.

Efectuarea de reparații la acest aparat cu laser este permisă numai persoanelor de specialitate autorizate.

Nu folosiți produsul în zone cu risc de explozie sau în medii agresive.

Pentru încărcarea bateriilor folosiți exclusiv încărcătoarele recomandate de producător.



Bateriile consumate nu trebuie aruncate împreună cu deșeurile menajere. Aveți grijă de mediul înconjurător și duceți-le la punctele de colectare, în conformitate cu reglementările naționale și locale. Produsul nu trebuie aruncat împreună cu deșeurile menajere.

Aruncați produsul în mod corespunzător, în conformitate cu reglementările naționale în vigoare în țara dvs. Respectați reglementările specifice de la nivel național și local. Adresați-vă autorităților locale sau comerciantului care v-a vândut aparatul pentru informații privind salubritatea.



Marcaj CE

DATE TEHNICE

Clasa de protecție	IP54 (protejat la praf și stropi de apă)
Optica	14 mm
Focalizare	35 mm
Domeniu de măsurare max.	50 metri (toleranță: 55m)
Domeniu de măsurare min.	0,05 metri
Precizie absolută @ < 10m	± 1,5 mm (max)
Precizie repetare @ < 10m	± 1,5 mm (tipic max. 2σ)
Precizie repetare @ > 10m	creștere ± 0,25 mm / metru (tipic max. 2σ)
Timp de măsurare	0,5 s
Tip display	LCD (22,7 mm x 31 mm)
Alimentarea electrică	AAA 2x (baterii alcaline)
Durata de viață a bateriilor	10000 (măsurătoare singulară)
Putere de ieșire laser	0,6 mW ~ 0,95 mW (clasa 2, 650nm)
Dimensiune punct laser	25 x 30 mm @ 16 m (max)
Unghi vertical fascicul laser	+1 grad
Unghi orizontal fascicul laser	±1 grad
Deconectare automată a aparatului	180 secunde
Deconectare automată laser	30 secunde
Intervalul temperaturii de lucru	-10°C la +50°C
Intervalul temperaturii de depozitare	-25°C la +70°C
Greutate fără baterii	80 g

CONDIȚII DE UTILIZARE SPECIFICATE

Aparatul de măsurare cu laser este indicat pentru măsurarea distanțelor și înclinațiilor.
Nu utilizați acest produs în alt mod decât cel stabilit pentru utilizare normală

TABEL CU CODURILE DE EROARE

Cod	Descriere	Soluție
Err01	În afara domeniului de măsurare	Efectuați măsurătoarea în domeniul specificat.
Err02	Semnalul reflectat este prea slab	Alegeți o suprafață mai bună.
Err03	În afara domeniului de afișare (val. max.: 99.999) de ex. este rezultatul de la suprafață sau volum în afara domeniului de afișare	Verificați dacă sunt corecte valorile și sunt corecți pașii.
Err04	Eroare în calculul Pitagora	Verificați dacă sunt corecte valorile și sunt corecți pașii.
Err05	Baterie descărcată	Introduceți baterii noi.
Err06	În afara intervalului de temperatură de lucru	Efectuați măsurătoarea în intervalul de temperatură de lucru specificat.
Err07	Lumină ambientă prea puternică	Întunecați zona țintă.

Diferență de înălțime
Pitagora

Nivel de măsurare

Măsurare lungimi

Minim / Maxim pentru măsurarea continuă

Adunare / Scădere

PORNIRE / MĂSURARE

- ▶ Pornire
- ▶ Măsurare
- ▶ Măsurare continuă (apăsare 2 sec.)
Funcție Min. / Max.

ADUNARE

- ▶ Adunare valoare
- ▶ Navigare în memorie

SUPRAFAȚĂ / VOLUM

- ▶ Suprafață (apăsare 1 dată)
- ▶ Volum (apăsare de 2ori)
- ▶ Măsurare indirectă de suprafață (apăsare 3ori / 4ori)

CONECTARE

- ▶ Pornire
- ▶ Oprire (apăsare 2 sec)
- ▶ Anulare

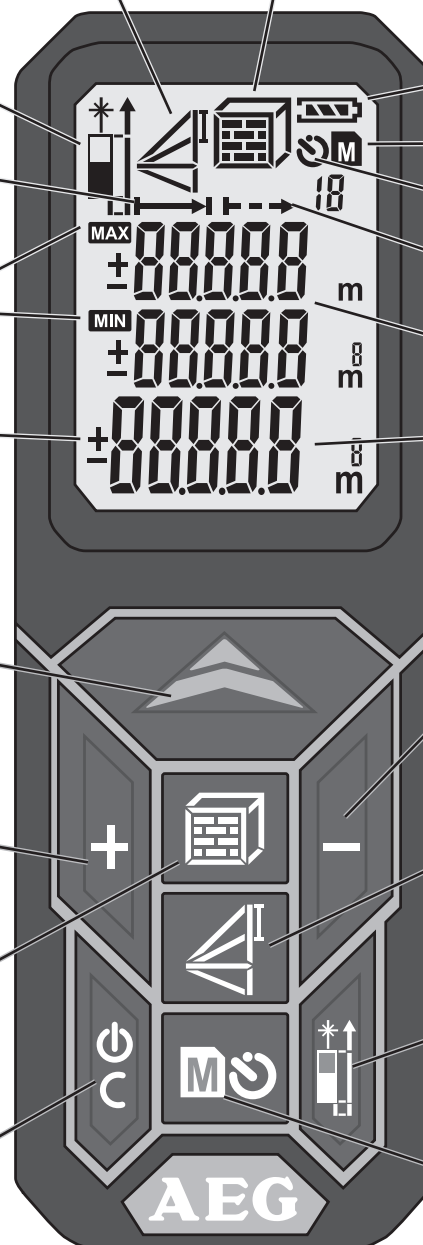

Suprafață / Volum
Măsurare indirectă de suprafață

Nivel baterii

Memorie

Timer

Măsurare continuă

Valori intermediare

Valoare totală

SCĂDERE

- ▶ Scădere valoare
- ▶ Navigare în memorie

PITAGORA

- ▶ Pitagora 1 (apăsare 1 dată)
- ▶ Pitagora 2 (apăsare 2ori)
- ▶ Pitagora 3 (apăsare 3ori)

SCHIMBARE NIVEL DE MĂSURARE

- ▶ În față
- ▶ În spate
- ▶ Știft colțuri

MEMORIE

- ▶ Timer 3-15 sec (apăsare 1 dată)
- ▶ Memorie 1-20 (apăsare 1 dată x 2 sec)
- ▶ Navigare în memorie cu tastele +/-

ÎNLOCUIRE BATERII

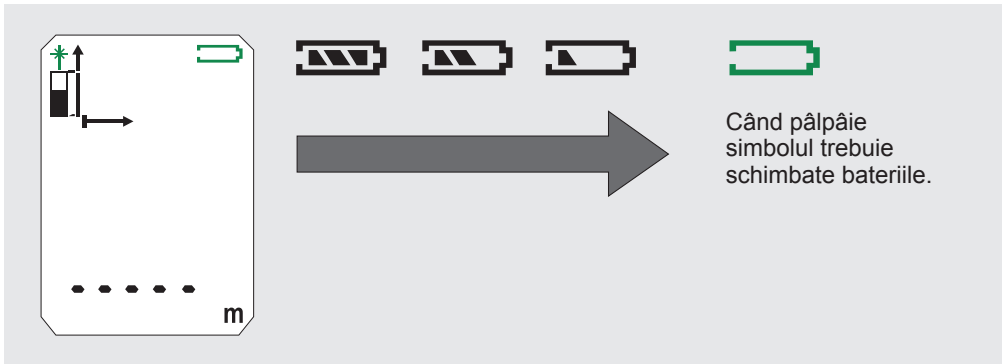

1

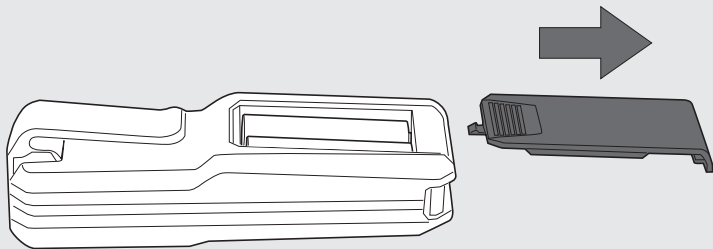

2

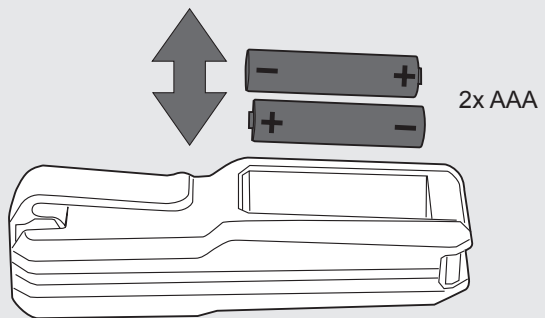

3

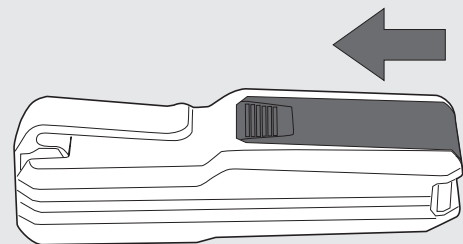

ȘTIȚ COLȚURI

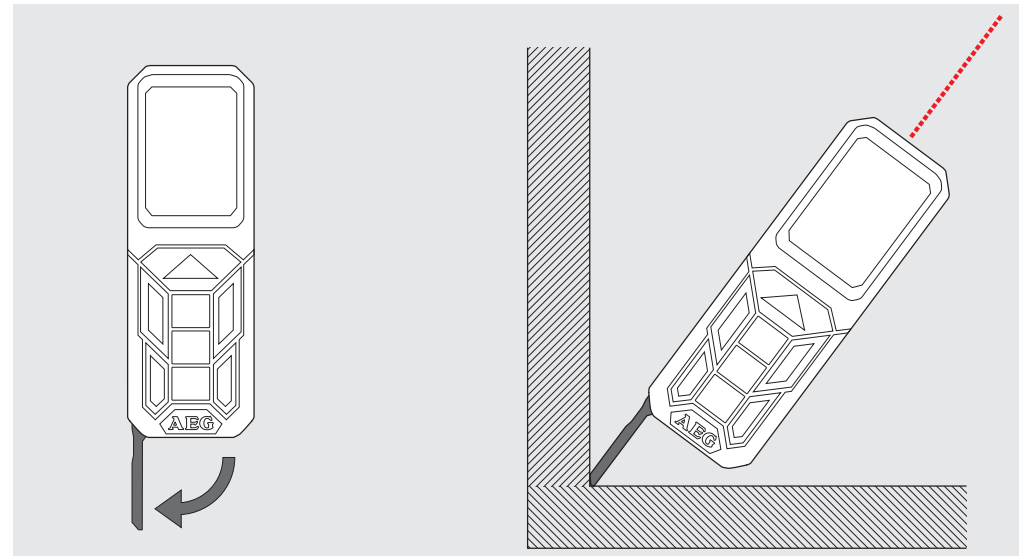

CLEMĂ DE CUREA

1

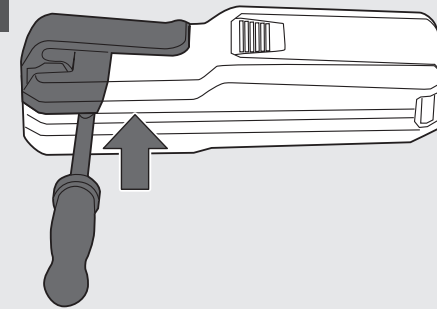

2

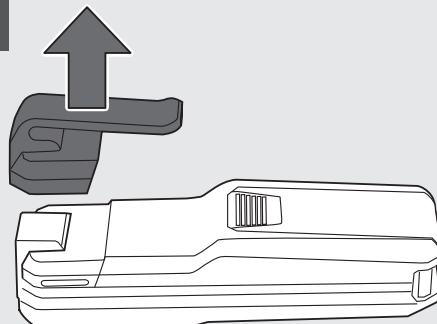

3

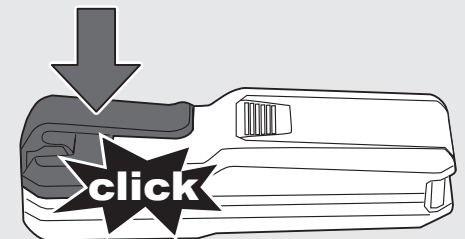

TASTE FUNCȚIONALE, PITAGORA, NIVEL DE MĂSURARE

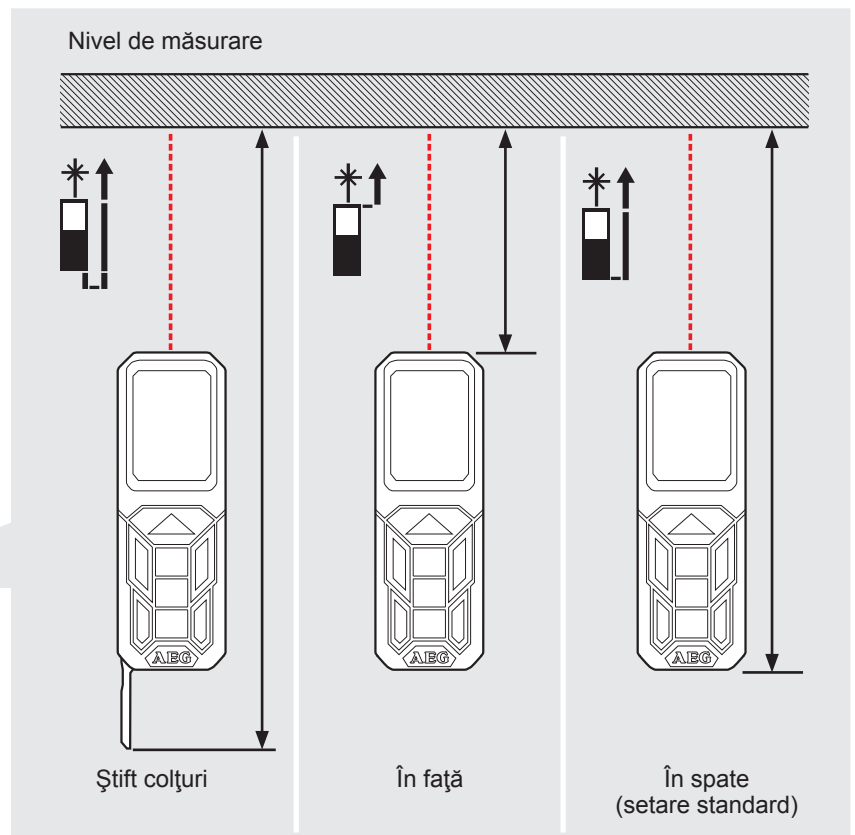
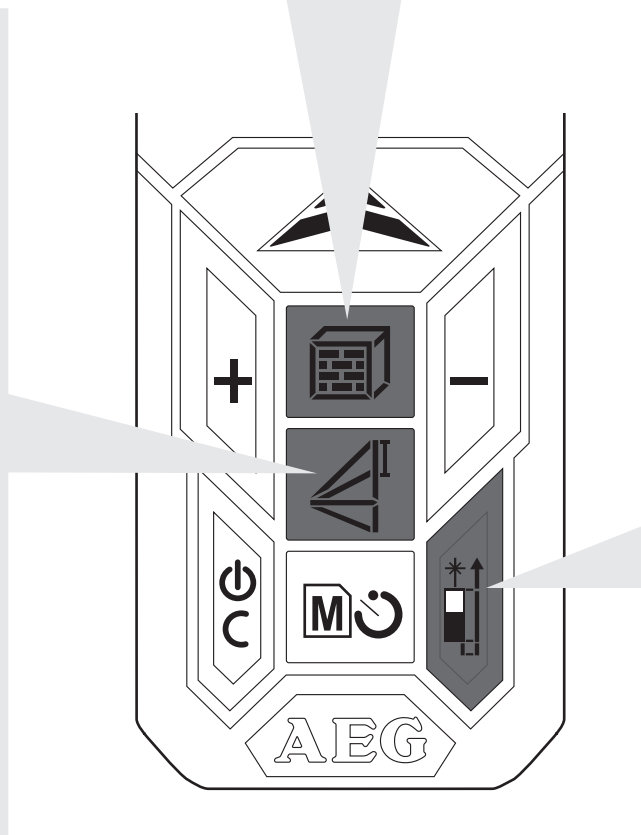
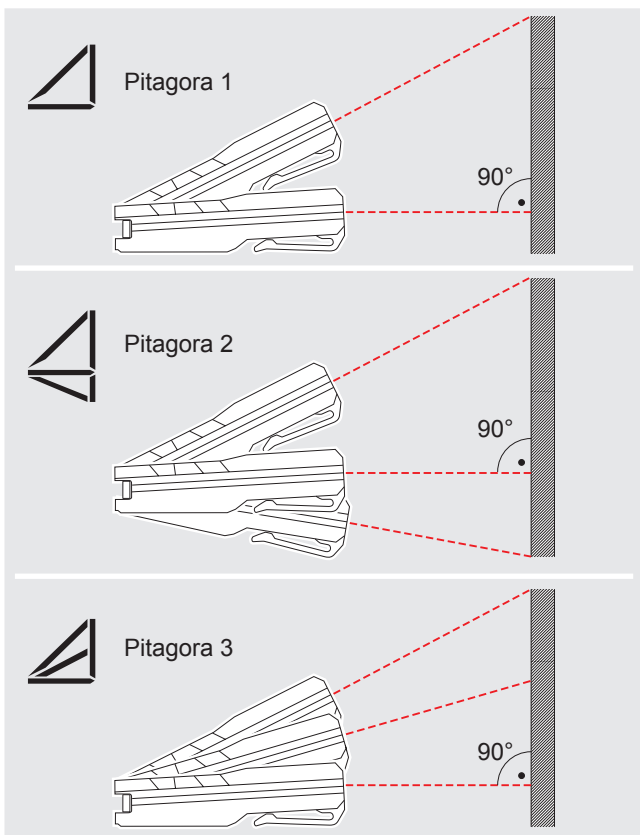
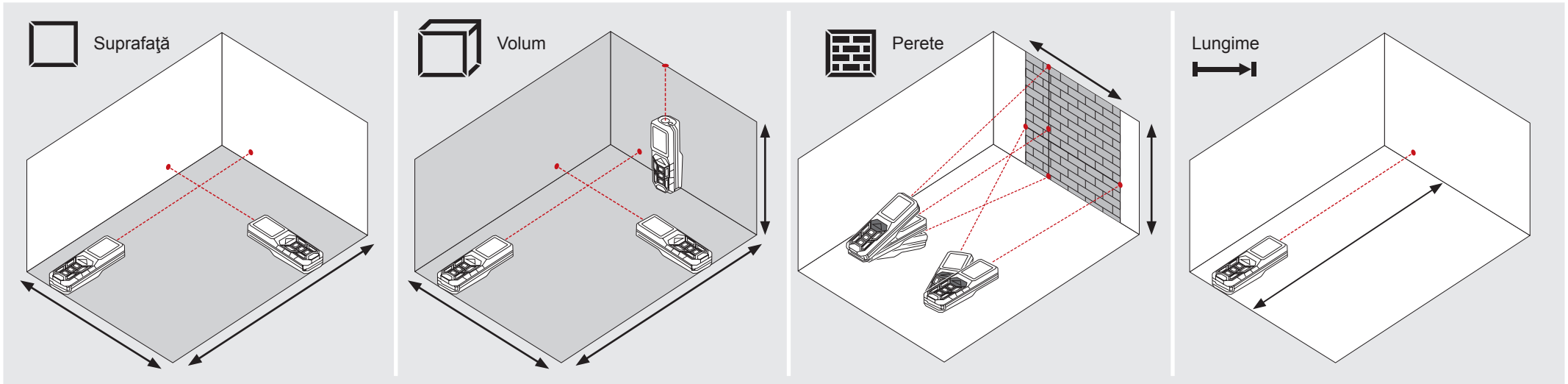

MĂSURARE SIMPLĂ DE LUNGIME

0

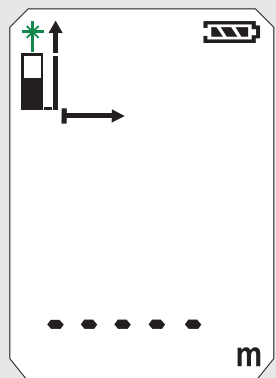

1

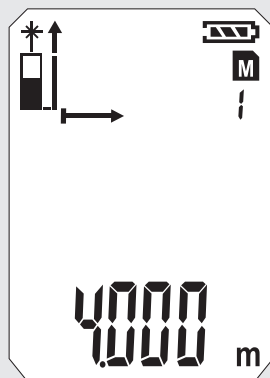
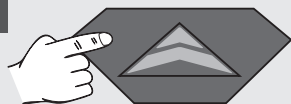

2

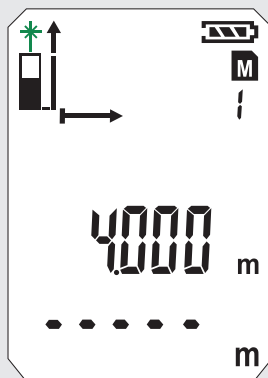
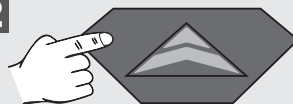

3

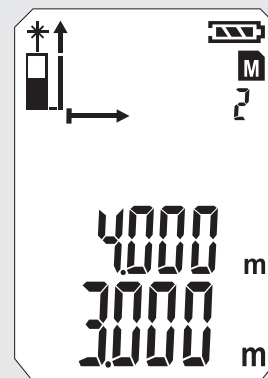
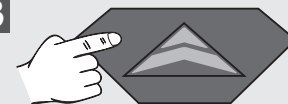

4

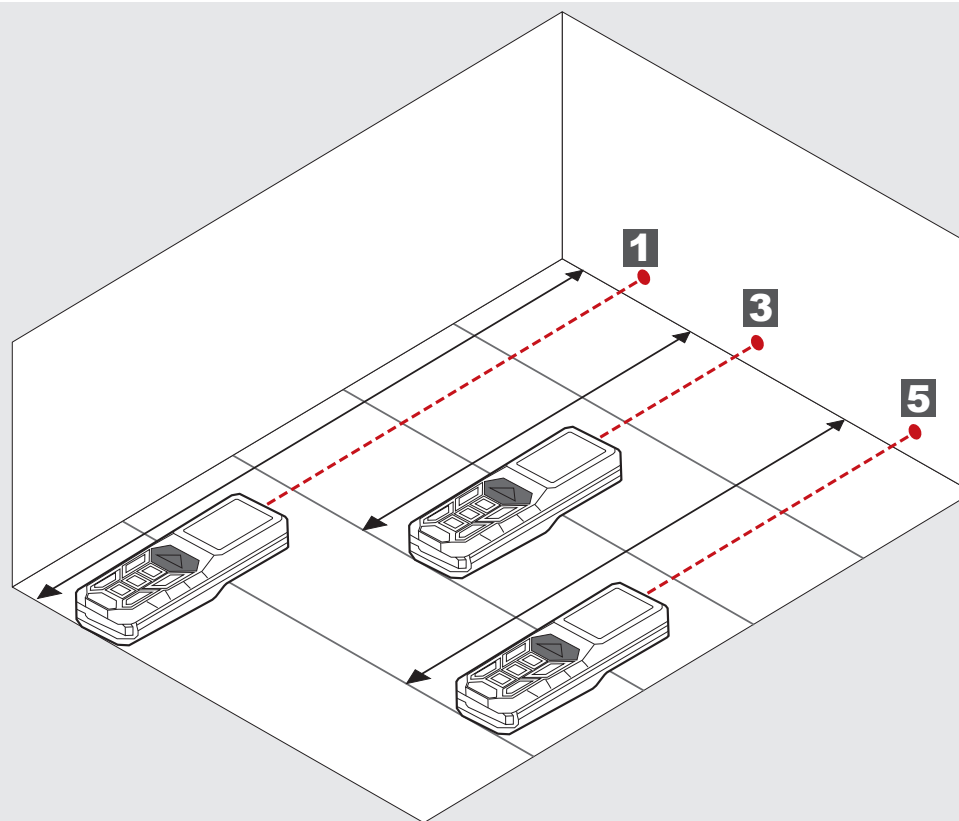
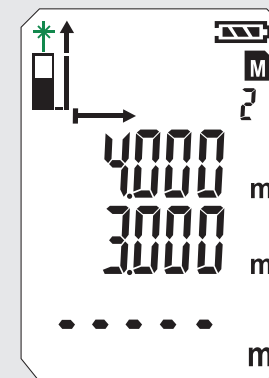
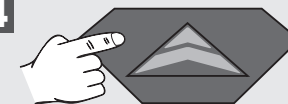

5

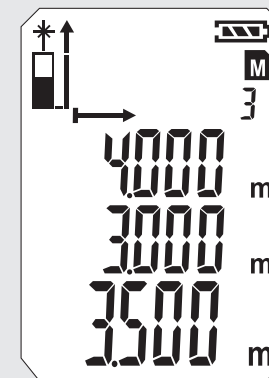
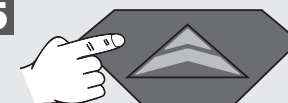

MĂSURARE CONTINUĂ / MĂSURARE MINIM-MAXIM

0

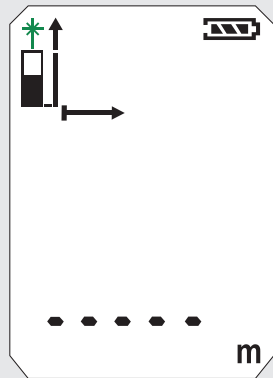

1

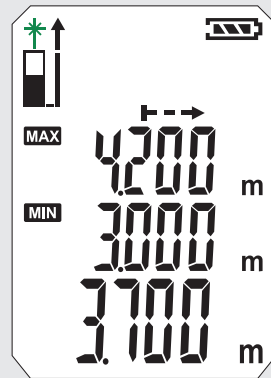
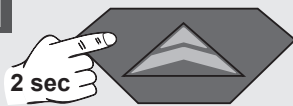

2

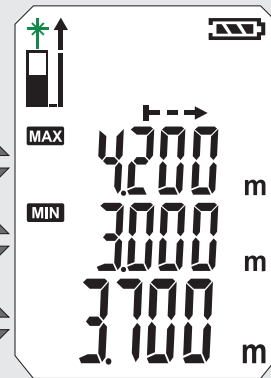

3

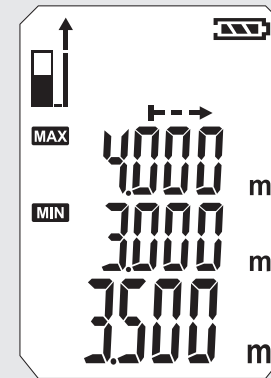
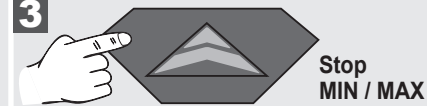

4

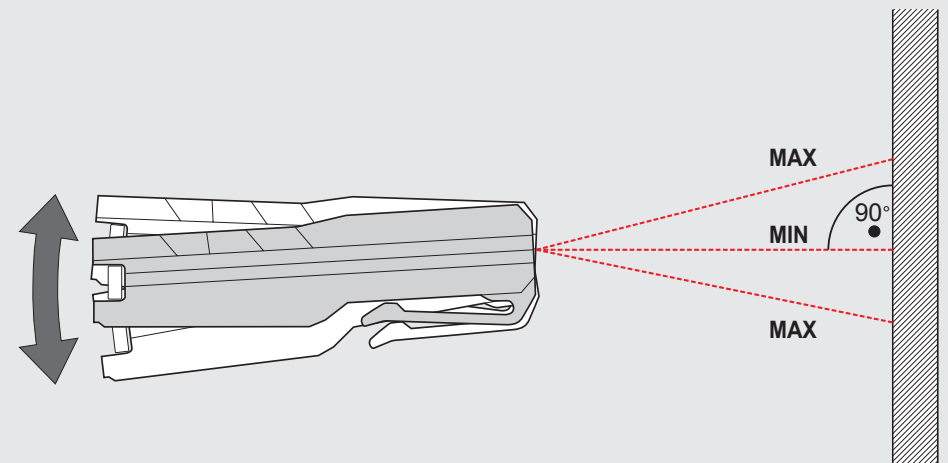
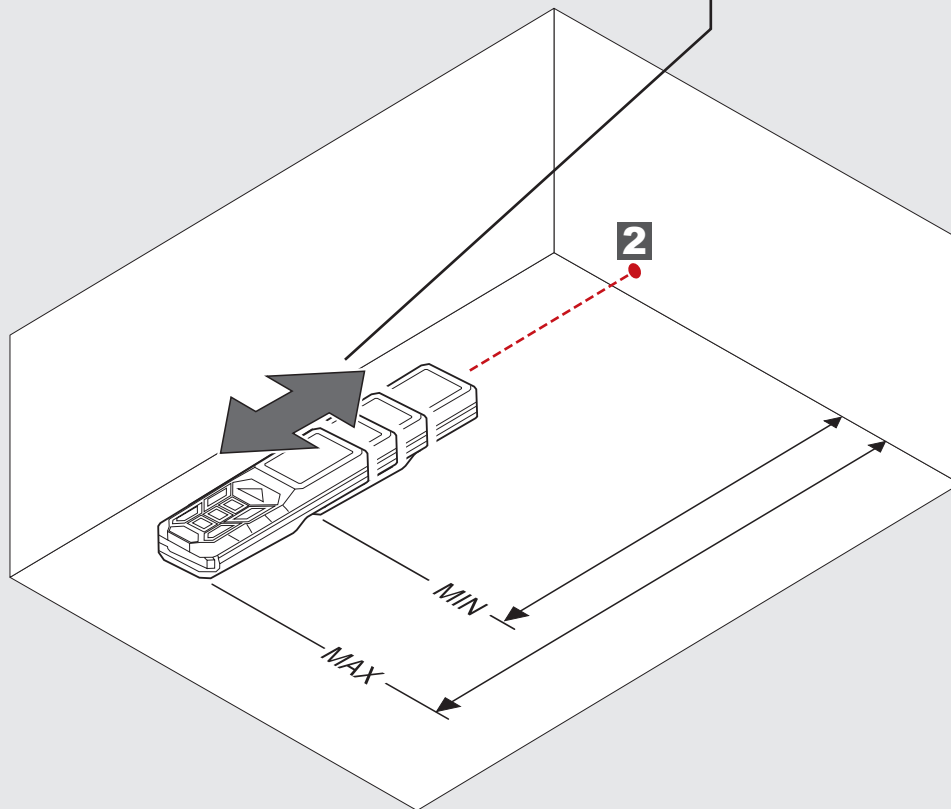
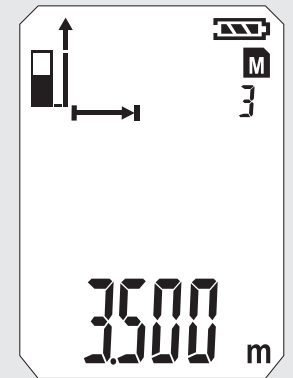
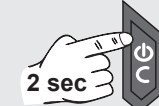

0

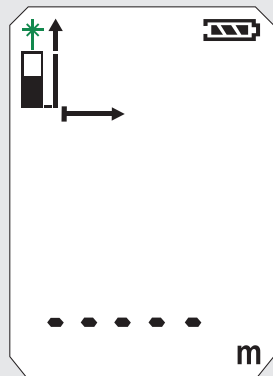

1

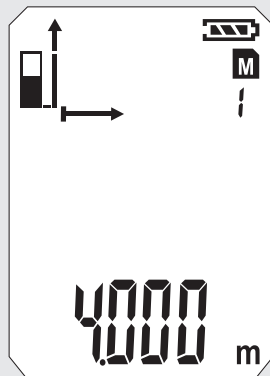
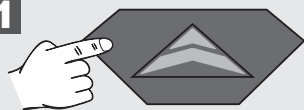

2

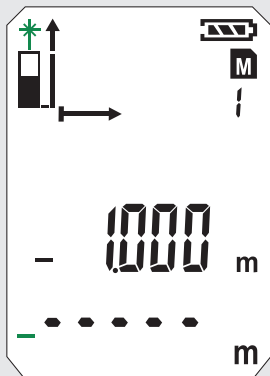

3

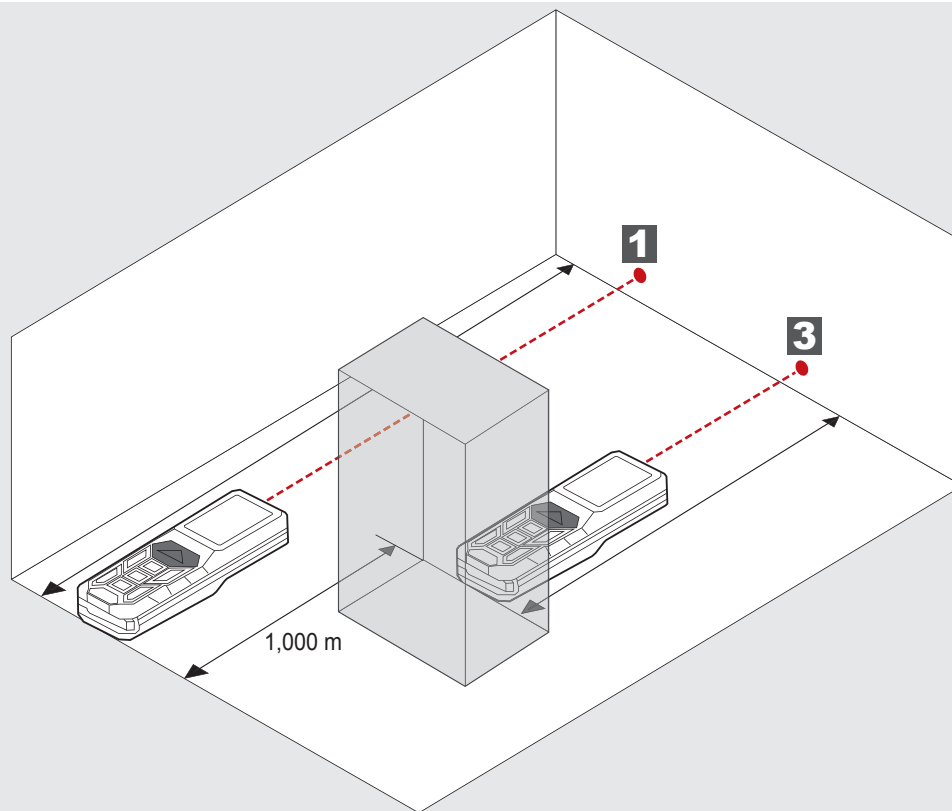
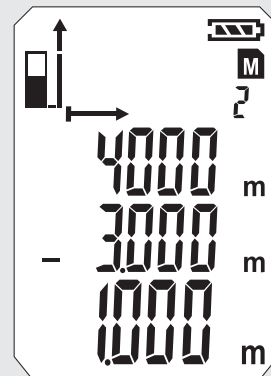
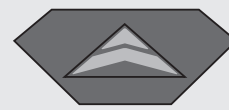

MĂSURARE SUPRAFAȚĂ

0



1

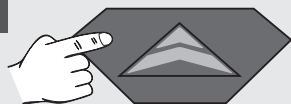

2

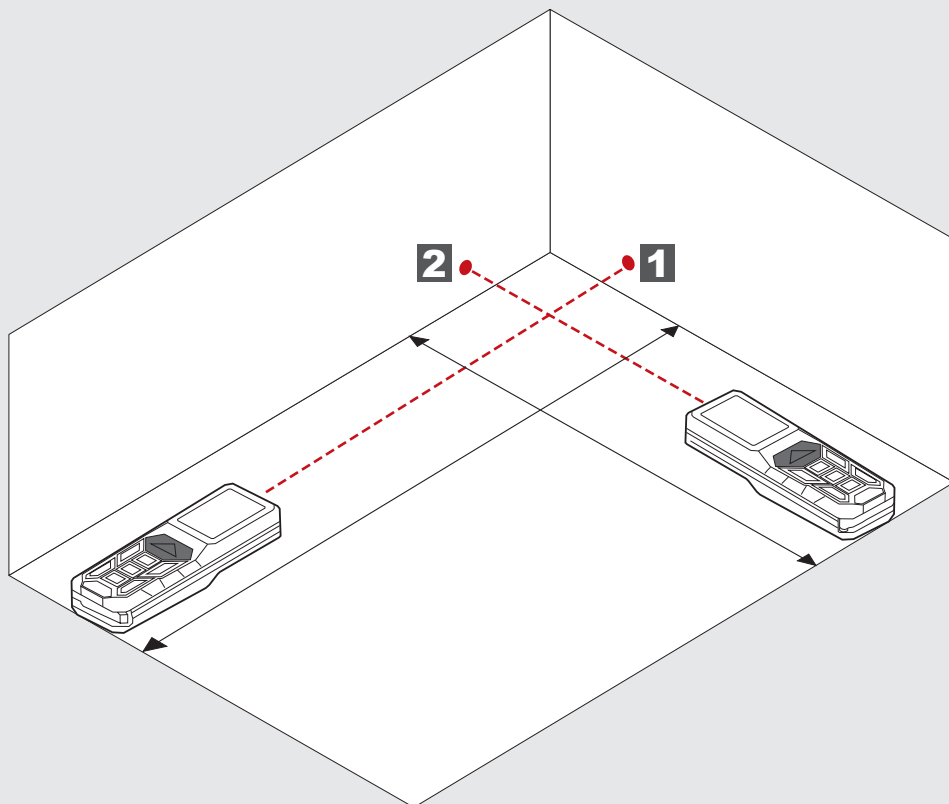
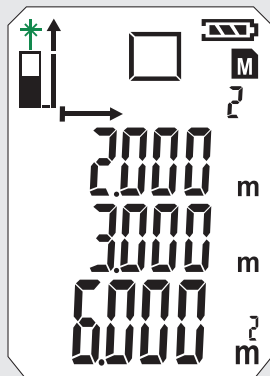
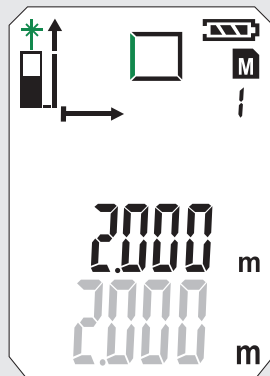
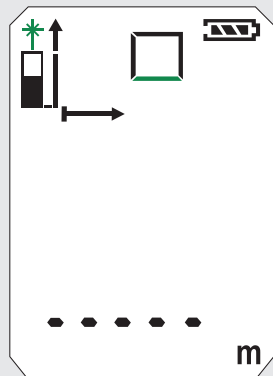
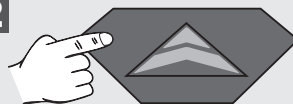

MĂSURARE VOLUM

0

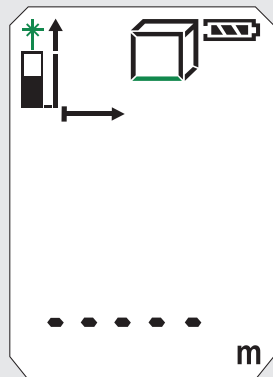

1

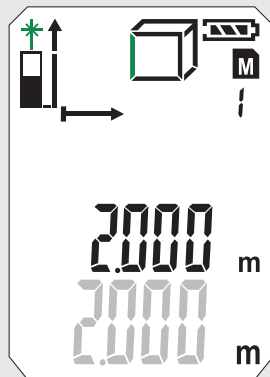
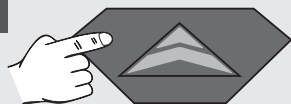

2

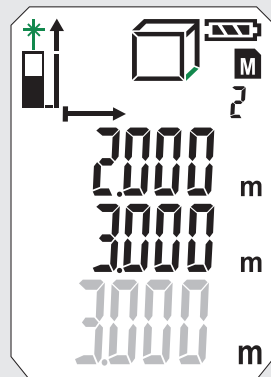
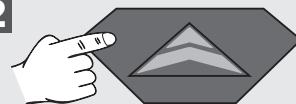

3

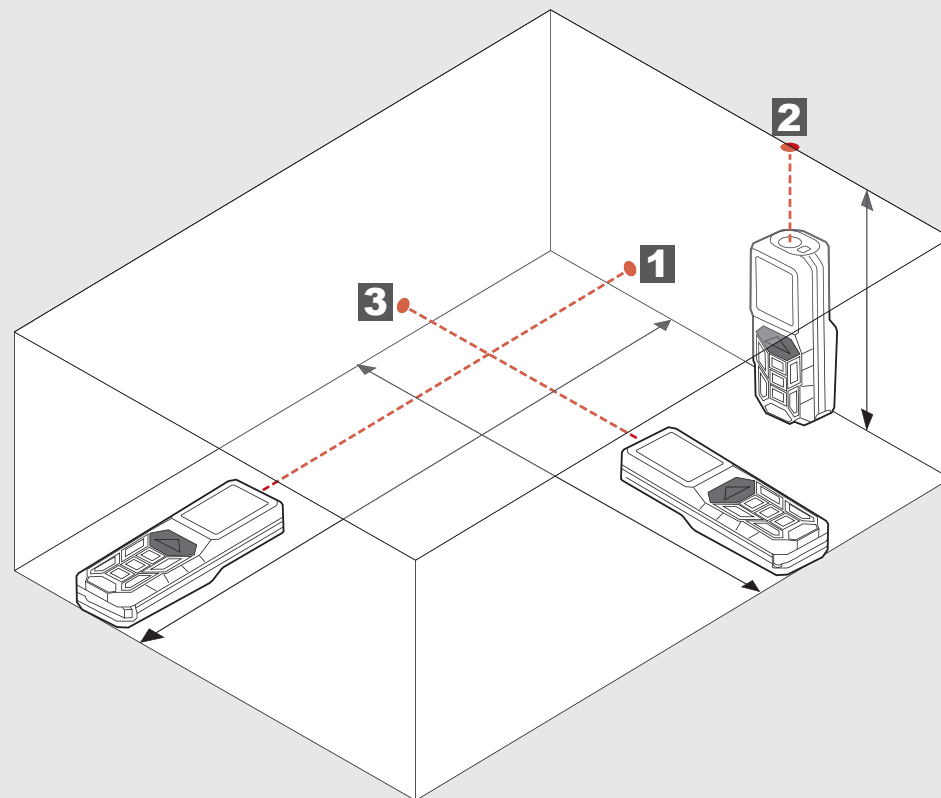
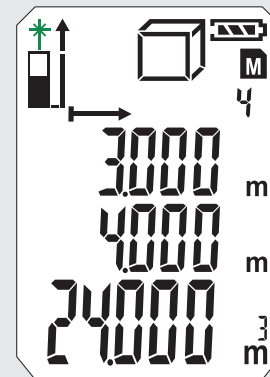
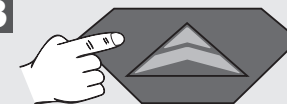

MĂSURARE INDIRECTĂ (PITAGORA 1)

0

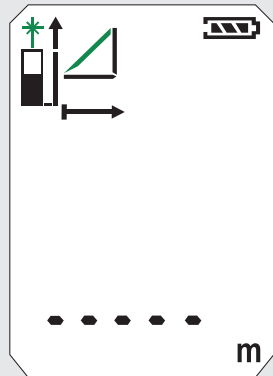

1

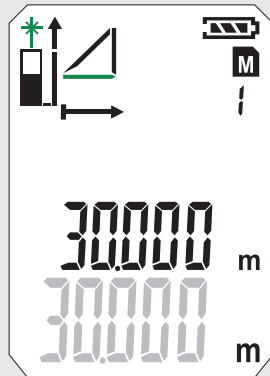
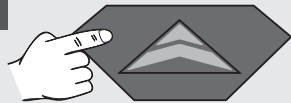

2

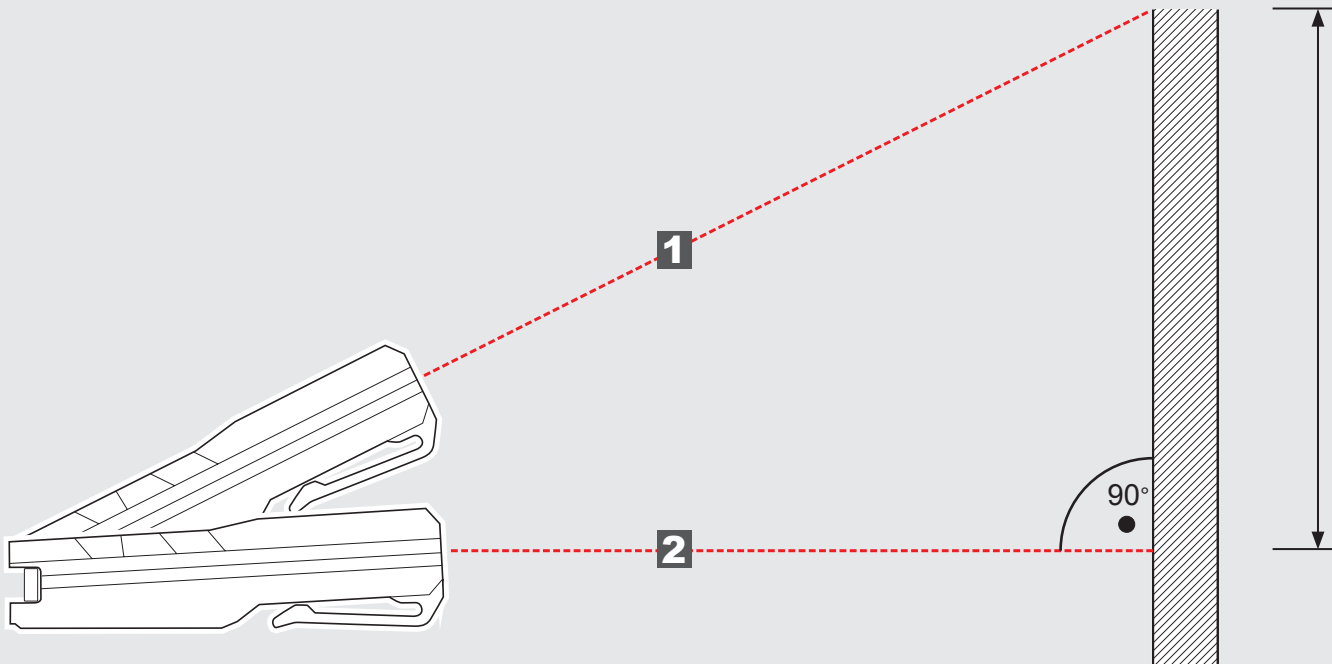
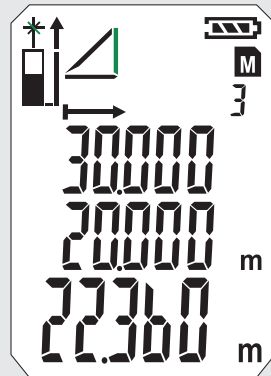
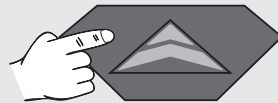

MĂSURARE INDIRECTĂ (PITAGORA 2)

0



1

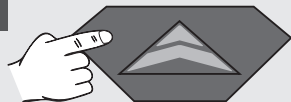

2



3

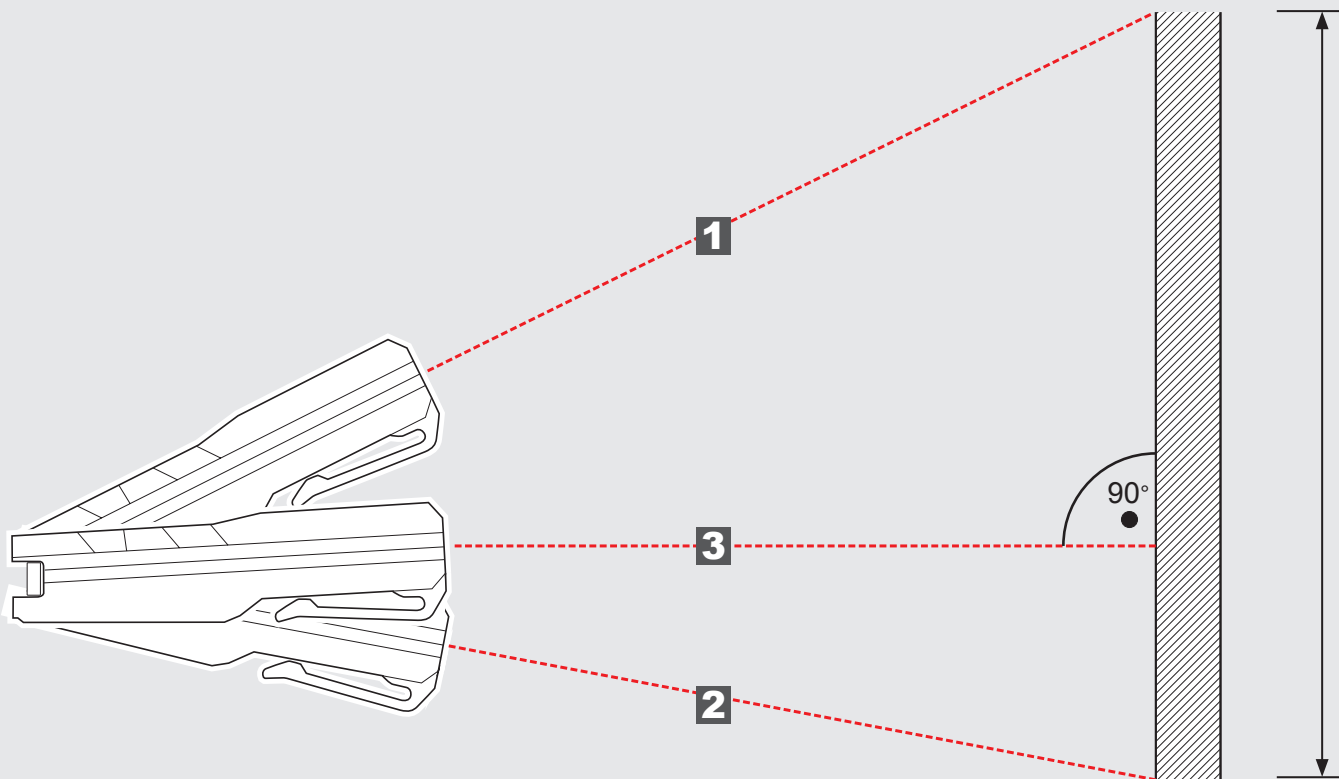
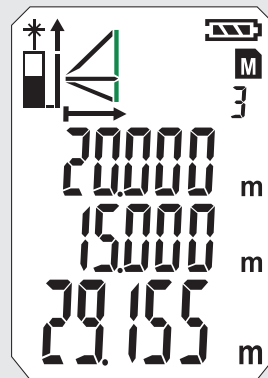
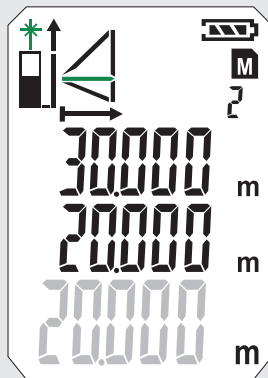
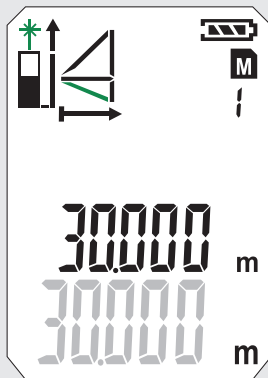
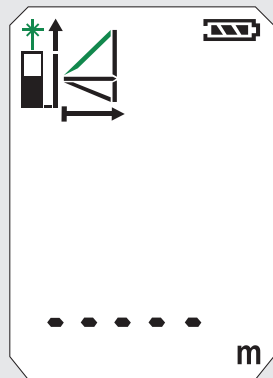

MĂSURARE INDIRECTĂ (PITAGORA 3)

1



2

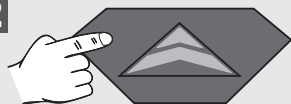

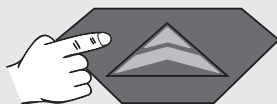

3

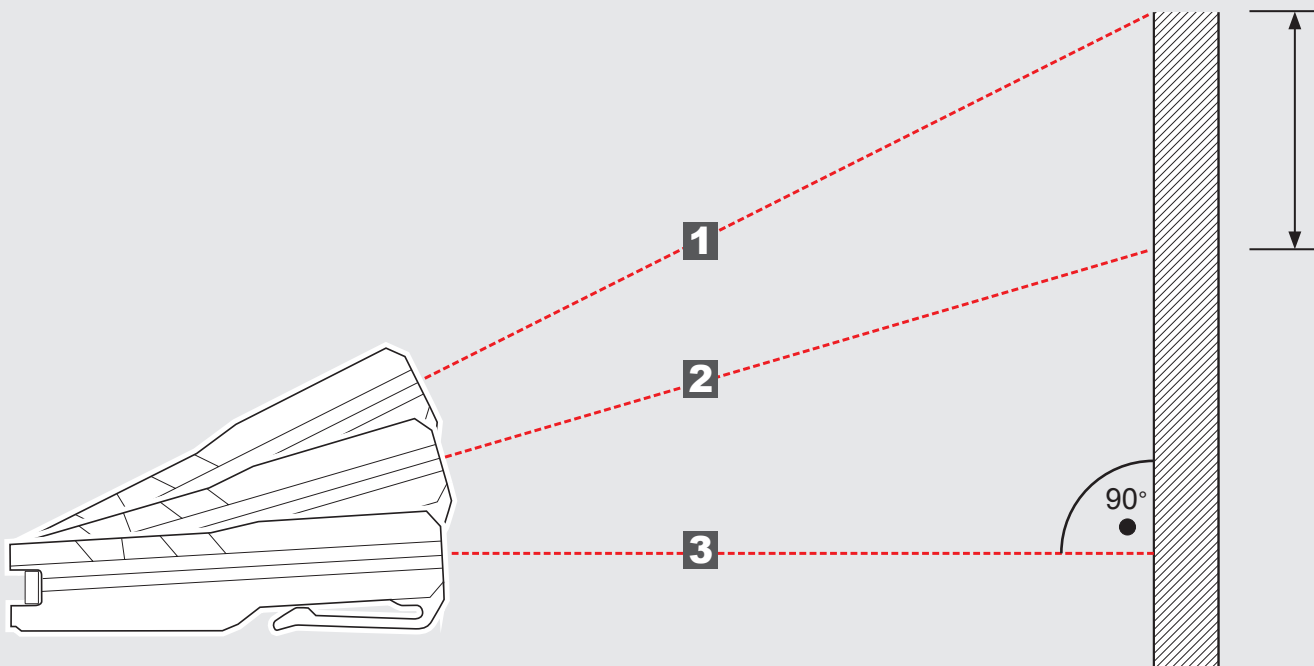
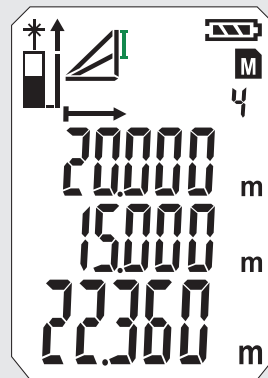
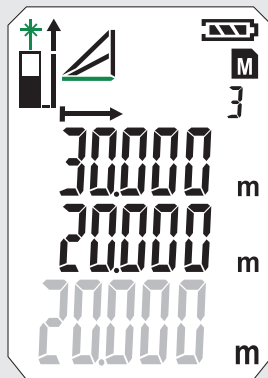
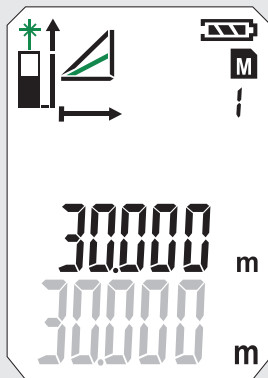
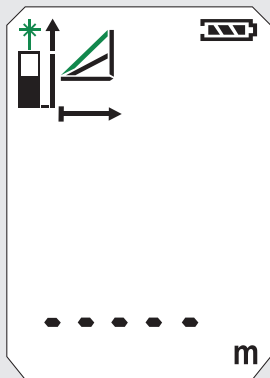

4

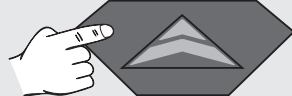
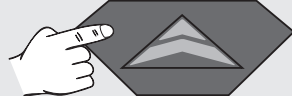
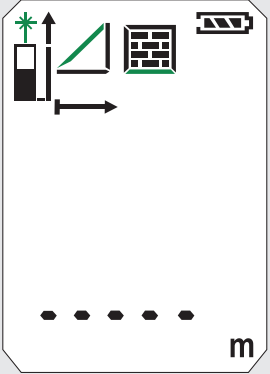
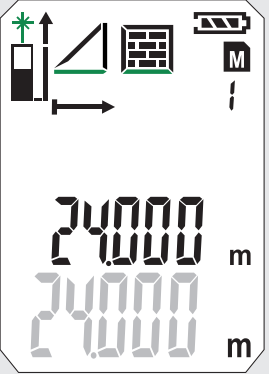
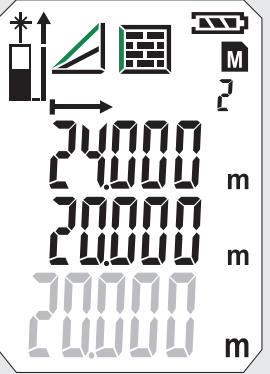
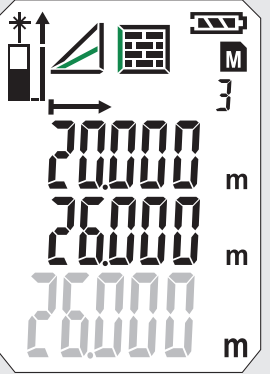
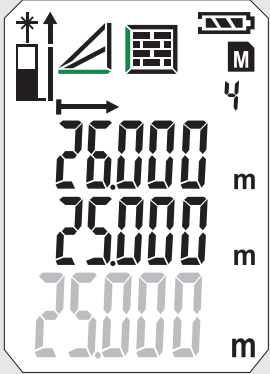

MĂSURARE SUPRAFAȚĂ PERETE (SCENARIU 2)

0 	1 	2 	3 	4 
				

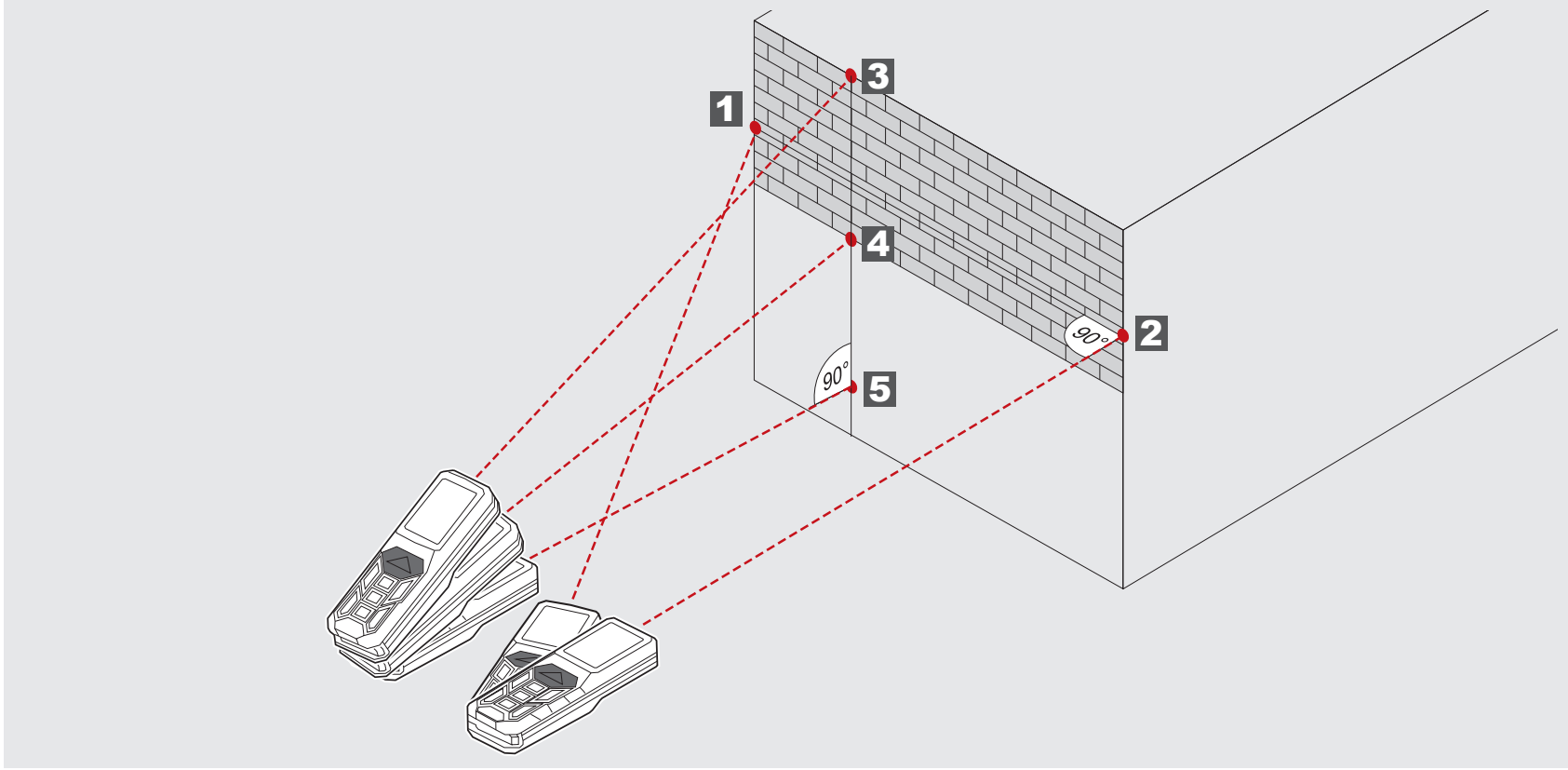

5



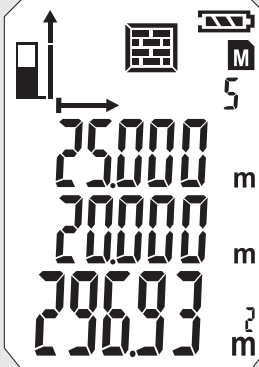



TIMER

Cu timer-ul se poate amâna pornirea măsurătorii, de ex. pentru a poziționa un element constructiv în fasciculul de măsurare.

Apăsați tasta 

- Apare simbolul  Prin apăsarea tastei  se poate regla timer-ul între 3 și 15 sec.

Apăsați tasta 

- Numărătoarea inversă a secundelor până la măsurare
- La 0 se pornește măsurătoarea.

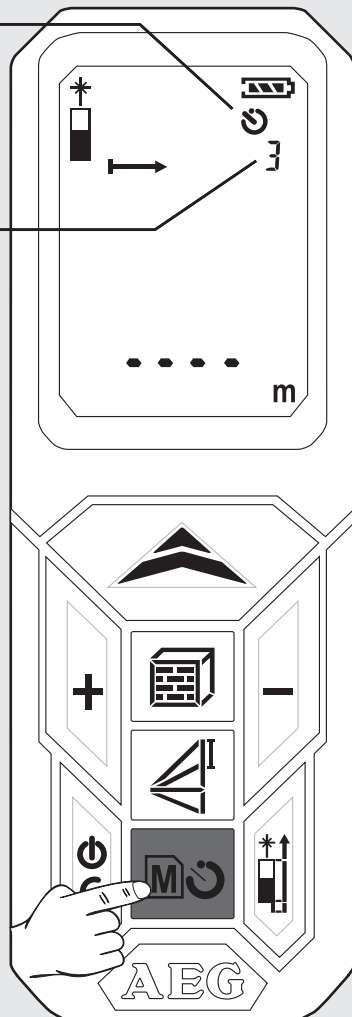

MEMORIA

Valorile sunt stocate continuu și automat în memorie.

Valorile stocate pot fi apelate cu tasta .

Apăsați tasta  2 sec

- Apare simbolul și numărul memoriei.
- Se afișează mărimea măsurată aferentă.
- Valoarea salvată este afișată în rândul principal.
- Navigați cu tastele +/-

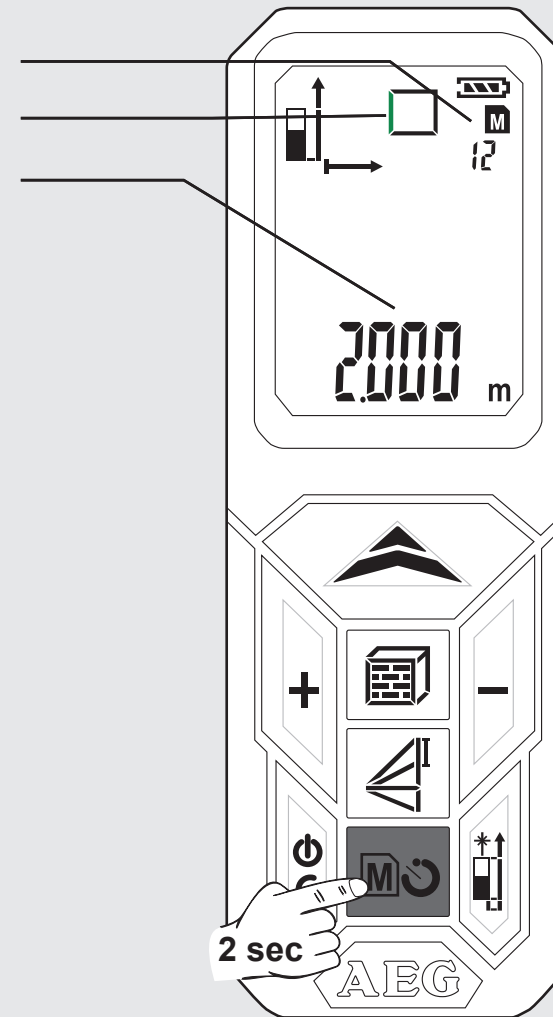

DESCRIEREA DE BAZĂ PE UN EXEMPLU DE MĂSURARE A SUPRAFETEI (1)



1 Porniți

Apăsați tasta .

⚠️ Atenție! Fascicul laser pornit!
A nu se orienta înspre persoane!

2 Selectați nivelul de măsurare

Setare standard după pornire: în spate

-  Apăsați 1 dată -> Știft colțuri
-  Apăsați de 2 ori -> în față
-  Apăsați de 3 ori -> în spate

3 Selectați funcția

După pornire, aparatul e întotdeauna pe măsurare de suprafață.
Apăsați 1 dată  - Măsurare suprafață

4 Măsurare lungime

Aparatul se aduce la nivel și se apasă tasta 

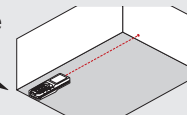

5 Măsurare lățime

Aparatul se aduce la nivel și se apasă tasta 

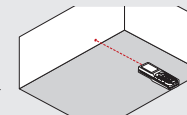

Symbolul laser pâlpâie (pâlpâire reprezentată cu verde).

Se afișează simbolul

- Apare simbolul
- Mărimea de măsurare pâlpâie (pâlpâire reprezentată cu verde)

- Valoarea măsurată apare pentru scurt timp în rândul principal.
- Valoarea măsurată sare după cca. 1 sec. în rândul de deasupra.
- Valoarea măsurată se stochează în memorie sub un număr curent.
- Pâlpâie a doua mărime de măsurare. Aparatul este pregătit pentru măsurarea celei de-a doua valori.

- Valoarea măsurată apare pentru scurt timp în rândul principal.
- Valoarea măsurată sare după cca. 1 sec. în rândul de deasupra.
- Valoarea măsurată se stochează în memorie sub un număr curent.
- Rezultatul este afișat în rândul principal și se stochează în memorie sub un număr curent.

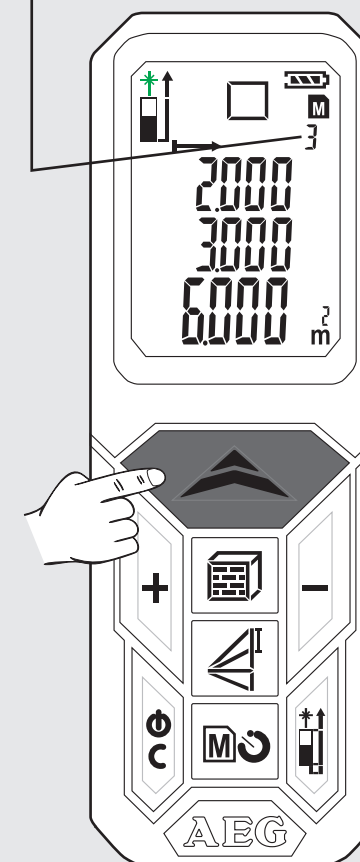
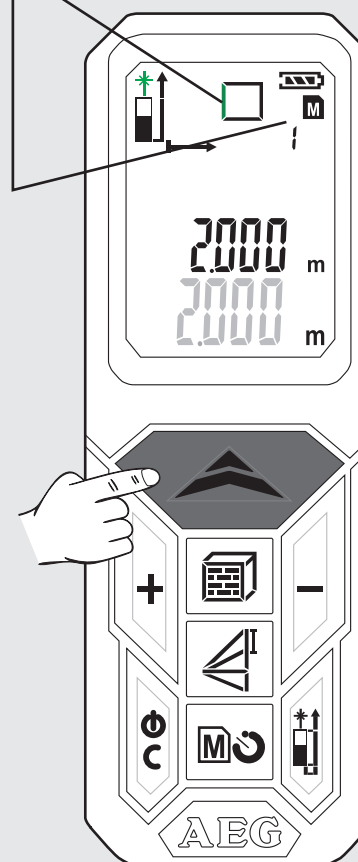
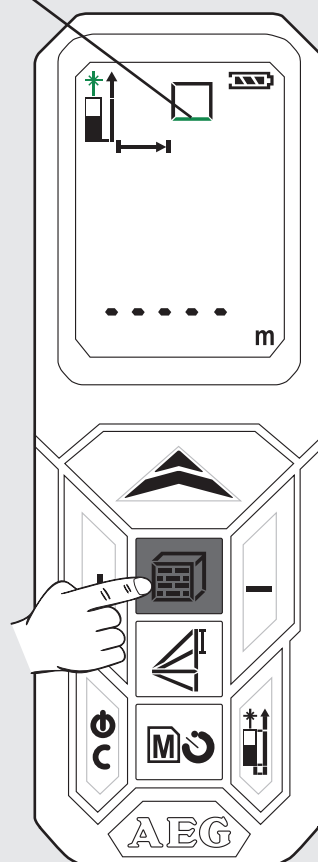
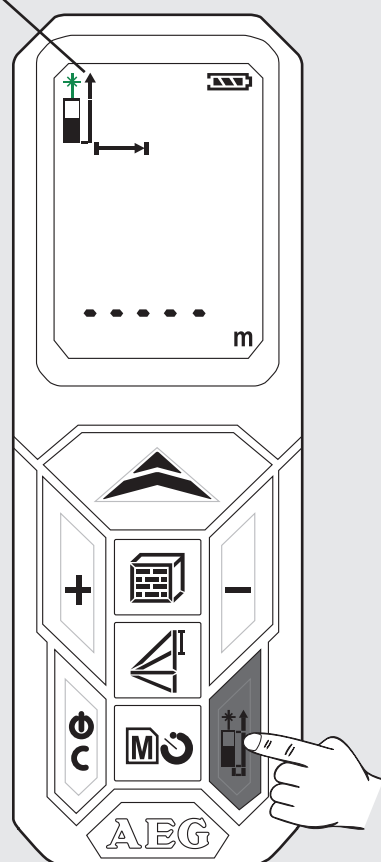
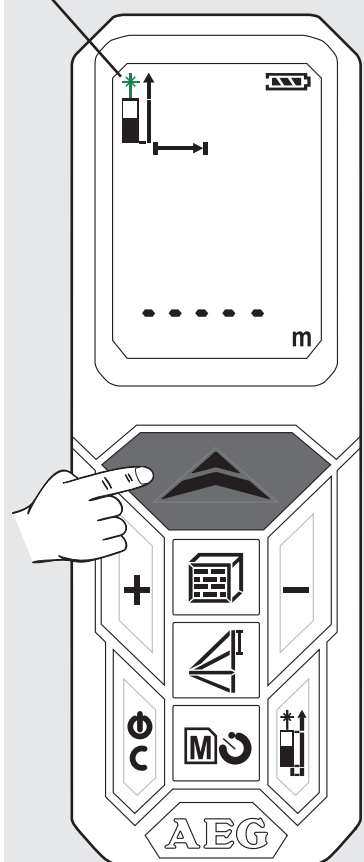

DESCRIEREA DE BAZĂ PE UN EXEMPLU DE MĂSURARE A SUPRAFETEI (2)

6 Vizualizarea valorilor salvate

Apăsați 2 sec. tasta .

Apăsați tasta + sau -

7 Părăsire memorie

Apăsați tasta .

8 Deconectarea

Apăsați 2 sec. tasta 
(Memoria trebuie părăsită înainte).

- Valorile salvate vor fi afișate în rândul principal.

- Este afișat simbolul aferent și pălpăie mărimea de măsurare (pălpăire reprezentată cu verde).

- Aparatul se oprește.

- Dacă timp de 3 minute nu se apasă nicio tastă, aparatul se deconectează automat.

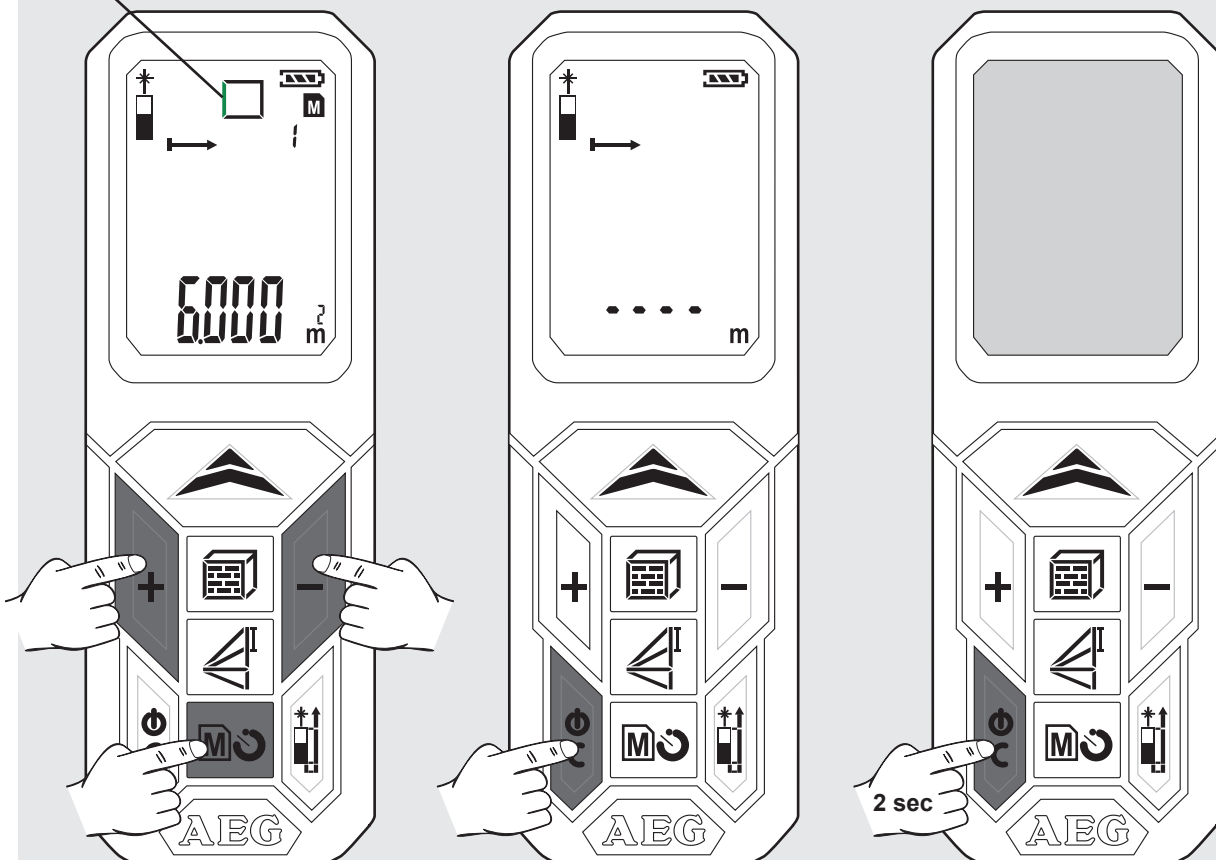

Важни напомени за безбедност.....	1
Технички податоци.....	2
Специфицирани услови на употреба.....	2
Табела со кодови на грешките.....	2
Преглед.....	3
Менување на батерија.....	4
Игличка за аголи.....	4
Држач на каишот.....	4
Копче за функции, Питагора, мерно ниво.....	5
Едноставно должинско мерење.....	6
Континуирано мерење / Мерење минимум-максимум.....	7
Мерење на додавање / одземање.....	8
Површинско мерење.....	9
Мерење на волуменот.....	10
Индириктно мерење (Питагора 1).....	11
Индириктно мерење (Питагора 2).....	12
Индириктно мерење (Питагора 3).....	13
Мерење на површината на сидот (сценарио 1).....	14
Мерење на површината на сидот (сценарио 2).....	15
Тајмер.....	16
Меморија.....	16
Основни начини на функционирање со примерот на површинско мерење (1).....	17
Основен начин на функционирање со примерот на површинско мерење (2).....	18

ВАЖНИ НАПОМЕНИ ЗА БЕЗБЕДНОСТ



Почнете да го употребувате производот дури откако ќе ги прочитате напомените за безбедност и упатството за употреба на приложеното ЦД.

Класификација на ласерите

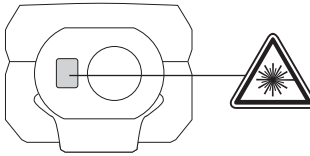

ПРЕДУПРЕДУВАЊЕ:

Производот одговара на ласерската класа 2 според EN 60825-1:2007.



Натпис

Пред првото пуштање во употреба поставете ја доставената лепенка на јазикот на вашата земја врз текстот на англиски јазик што се наоѓа на плочката со карактеристики.

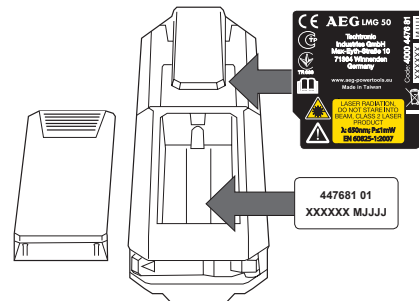

Предупредување:

Избегнувајте директен контакт со очите. Ласерскиот зрак може да ги заслепи очите и да доведе до краткорочно слепило.

Не погледнувајте во ласерскиот зрак и зракот не го усмерувајте непотребно према други лица.

Не заслепувајте други луѓе со светлината.

Предупредување:

Ласерскиот апарат не смее да се употребува во близина на деца ниту пак на деца смее да им се дозволи да го користат ласерскиот апарат.

Внимание! Рефлектирачка површина би можела да го врати ласерскиот зрак назад до корисникот или до други лица.

Одржувајте прикладно безбедно растојание кон подвижните делови.

Редовните контролни мерења мора да се спроведуваат, посебно пред, за време и после важни мерни задачи.

Внимавајте на фалични мерења во случај на употреба на дефектен производ, после негово паѓање на земја или некоја друга недозволива примена односно измена на производот.

Внимание! Запознајте се добро со елементите на ракување и со уредната употреба на апаратот.

Ласерскиот мерен апарат има ограничено подрачје на употреба. (Види во делот "Технички податоци"). Секакви обиди да се вршат мерења вон максималното и минималното подрачје доведуваат до непрецизности. Примената во случај на лоши услови како што е на пример премногу жешко, премногу студено, многу силна сончева светлина, дожд, снег, магла или други услови кои што го ограничуваат видното поле, може да доведе до непрецизни мерења.

Кога ласерскиот мерен апарат од топла околина се донесува во студена околина (или обратно), почекајте додека апаратот да се прилагоди на температурата на новата околина.

Ласерскиот мерен апарат чувајте го секогаш во простории, а апаратот чувајте го од потреси, вибрации или екстремни температури.

Ласерскиот мерен апарат заштитете го од прав, влага и висока влажност на воздухот. Таквите услови можат да ги уништат внатрешните делови на апаратот или пак да извршат влијание врз прецизноста.

Не употребувајте агресивни средства за чистење или средства за растворање. Чистете исклучиво со чиста, мека крпа.

Избегнувајте силни удари на ласерскиот мерен апарат или негово паѓање. Прецизноста на апаратот треба веднаш да се провери доколку истиот Ви паднал или доколку бил изложен на друг вид механичко оптоварување.

Потребните поправки на овој ласерски апарат смеат да се изведуваат само од страна на авторизиран стручен персонал.

Производот не смее да се примени во околина во која што постои опасност од експлозии или е агресивна сама по себе.

За полнење на батеријата треба да се употребуваат исклучиво апаратите за полнење препорачани од страна на производителот.



Празни батерии не смеат да се фрлаат заедно со домашниот отпад. Потрошени батерии заради целта на нивно отстранување, а притоа запазувајќи ја околината во склад со националните и локалните прописи, се предаваат на за таа намена предвидените собирни места. Апаратот не смее да се фрли во домашниот отпад. Апаратот мора стручно да се отстрани. Притоа обратете внимание на прописите за фрлање кои што се однесуваат на конкретната земја. Обратете се до местните служби или до Вашиот продавач за да добиете информации во врска со фрлањето на овој отпад.



ТЕХНИЧКИ ПОДАТОЦИ

Заштитна класа	IP54 (заштитено од прав и вода што прска)
Оптика	14 mm
Средишна точка	35 mm
Мерно подрачје макс.	50 метри (толеранција: 55m)
Мерно подрачје мин.	0,05 метри
Апсолутна прецизност @ < 10m	± 1,5 mm (макс)
Прецизност на повторувања @ < 10m	± 1,5 mm (типично макс. 2σ)
Прецизност на повторувања @ > 10m	пораст ± 0,25 mm / метри (типично макс. 2σ)
Мерно време	0,5 секунда
Дисплеј тип	ЛЦД (22,7 mm x 31 mm)
Снабдување со струја	AAA 2x (алкална батерија)
Рок на траење на батеријата	10000 (поединечно мерење)
Ласер појдовен учинок	0,6 mW ~ 0,95 mW (Class 2, 650nm)
Големина на ласерска точка	25 x 30 mm @ 16 m (макс)
Ласерски зрак Вертикален агол	+1 степен
Ласерски зрак Хоризонтален агол	±1 степен
Автоматско исклучување на апаратот	180 секунди
Автоматско исклучување на ласерот	30 секунди
Подрачје на работна температура	-10°C to +50°C
Подрачје на температурата на складирање	-25°C to +70°C
Тежина без батерија	80 г

СПЕЦИФИЦИРАНИ УСЛОВИ НА УПОТРЕБА

Ласерскиот мерен апарат е погоден за мерење на дистанци и нагиби.

Не го користете овој производ на било кој друг начин освен пропишаниот за нормална употреба.

ТАБЕЛА СО КОДОВИ НА ГРЕШКИТЕ

Код	Опис	Решение
Err01	Надвор од мерното подрачје	Мерењето да се изврши во предвиденото подрачје.
Err02	Рефлектираниот сигнал е премногу слаб	Изберете подобра површина.
Err03	Надвор од индикаторското подрачје (макс. вредност: 99.999) на пр. резултатот од површината или од волуменот се наоѓа надвор од индикаторското подрачје	Проверете дали вредностите и чекорите се исправни.
Err04	Грешка во питагорината пресметка	Проверете дали вредностите и чекорите се исправни.
Err05	Батеријата е слаба	Ставете нови батерии.
Err06	Надвор од подрачјето на работна температура	Мерењето да се спроведе во предвиденото подрачје на работна температура.
Err07	Околното осветлување е премногу светло	Затемнете го целното подрачје.

Питагора
Висинска разлика

Мерно ниво

Должинско мерење

Минимум / максимум за континуирано мерење

Додавање / одземање

ВКЛУЧЕНО / МЕРЕЊЕ

- ▶ Вклучено
- ▶ Мерење
- ▶ Континуирано мерење (притискај 2 сек)
Функција на мин. / макс.

ДОДАВАЊЕ

- ▶ Додавање на вредноста
- ▶ Навигирање во меморијата

ПОВРШИНА / ВОЛУМЕН

- ▶ Површина (притисни 1x)
- ▶ Волумен (притисни 2x)
- ▶ Индиректно површинско мерење (притисни 3x / 4x)

ВКЛУЧУВАЊЕ

- ▶ Вклучено
- ▶ Исклучено (притисни 2 сек.)
- ▶ Ресетирање

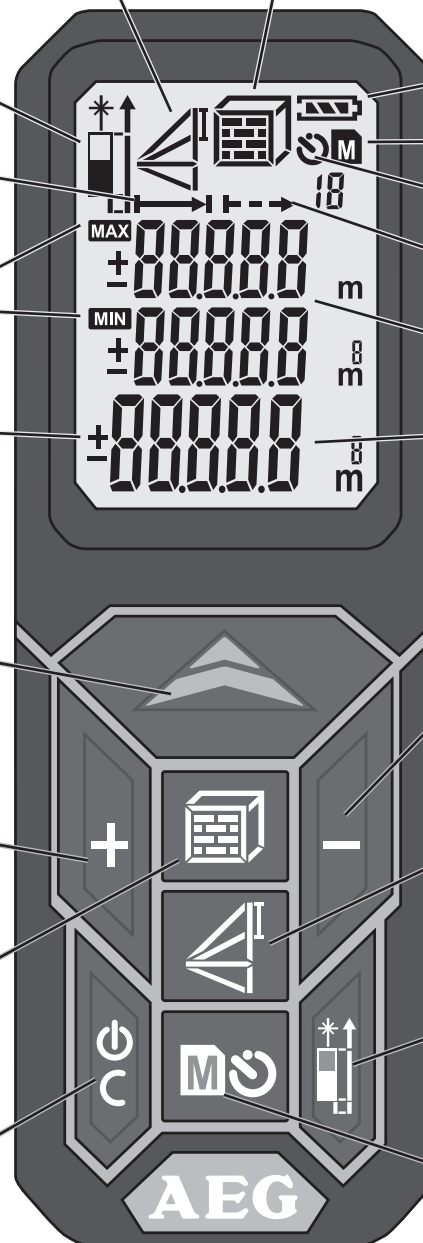

Површина / волумен
Индиректно површинско мерење

Статус на батеријата

Меморија

Тајмер

Континуирано мерење

Меѓувредности

Вкупна вредност

ОДЗЕМАЊЕ

- ▶ Одземање на вредноста
- ▶ Навигирање во меморијата

ПИТАГОРА

- ▶ Питагора 1 (притисни 1x)
- ▶ Питагора 2 (притисни 2x)
- ▶ Питагора 3 (притисни 3x)

МЕНУВАЊЕ НА МЕРНОТО НИВО

- ▶ Напред
- ▶ Назад
- ▶ Игличка за аголи

МЕМОРИЈА

- ▶ Тајмер 3-15 сек (притисни 1x)
- ▶ Меморија 1-20 (притисни 2 сек 1x)
- ▶ Навигирај со копчињата +/- во меморијата

МЕНУВАЊЕ НА БАТЕРИЈА

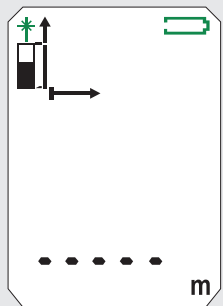

Кога симболот трепка, сменете ја батеријата.

1

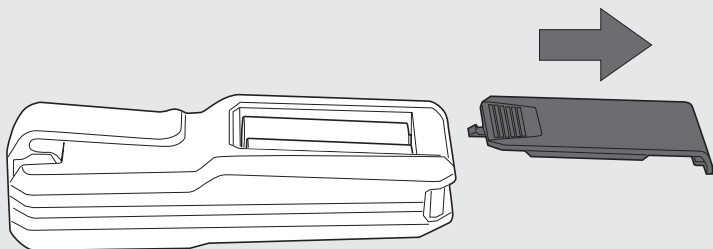

2

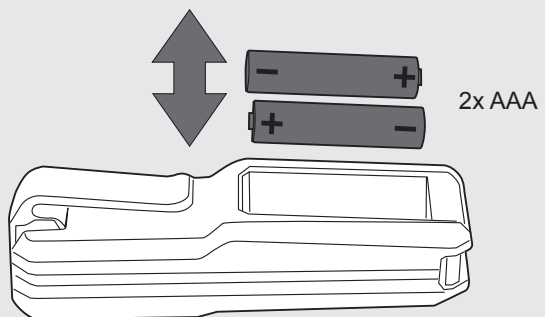

3

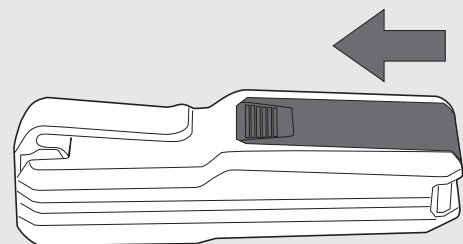

ИГЛИЧКА ЗА АГОЛИ

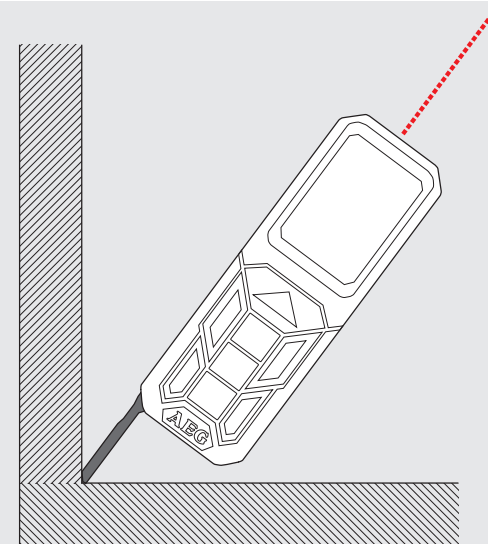
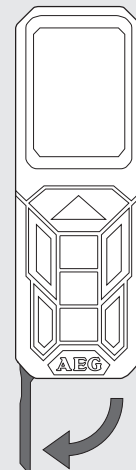

ДРЖАЧ НА КАИШОТ

1

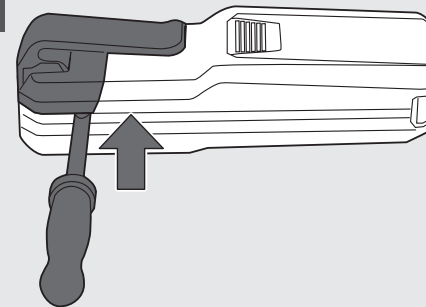

2

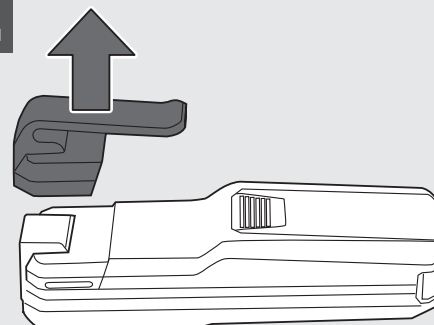

3

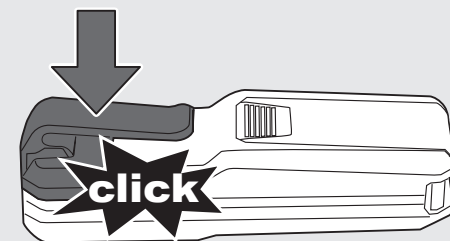

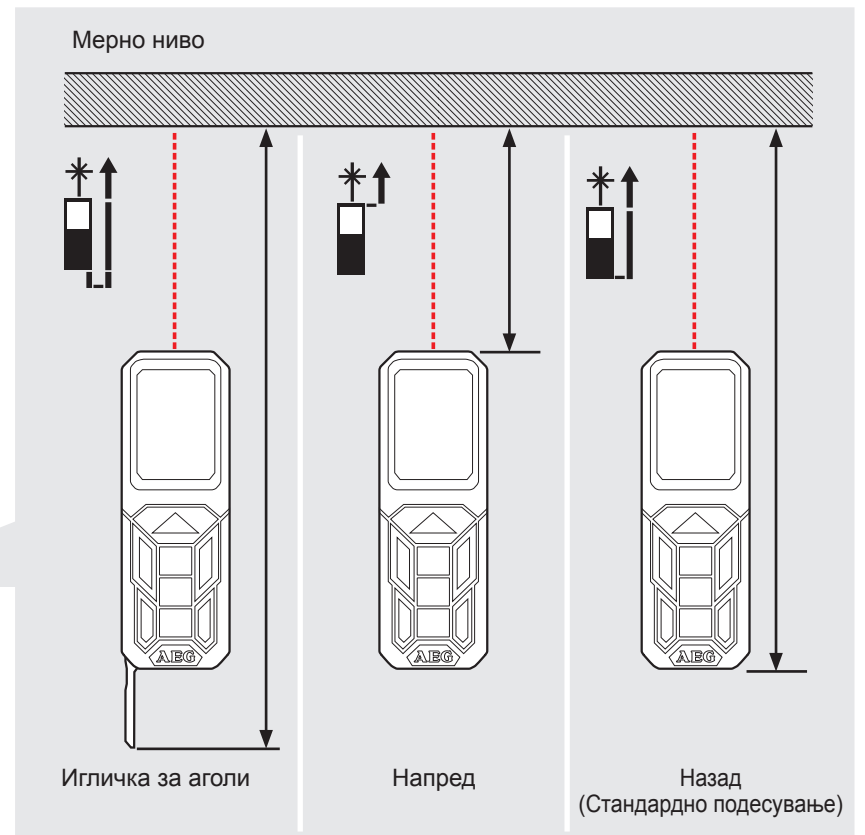
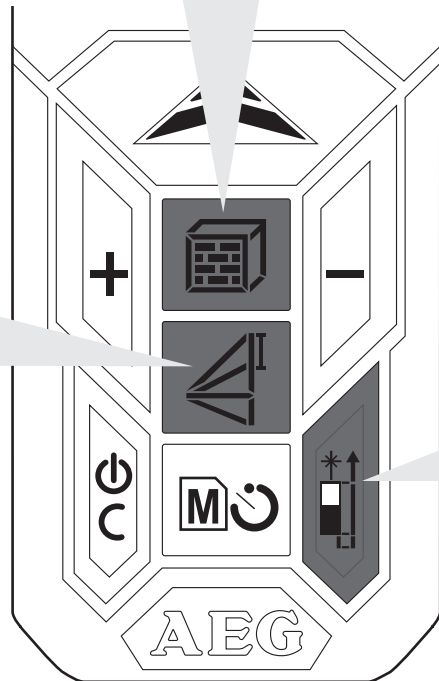
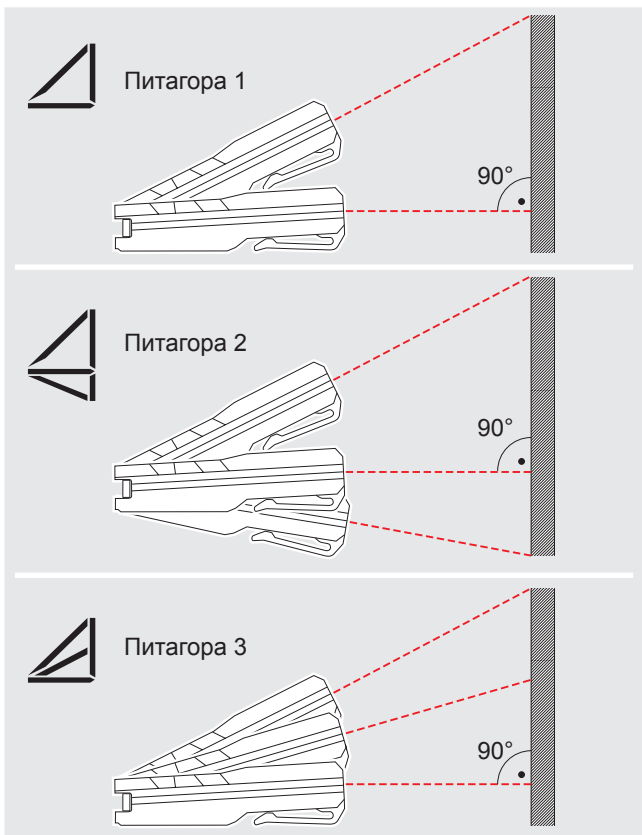
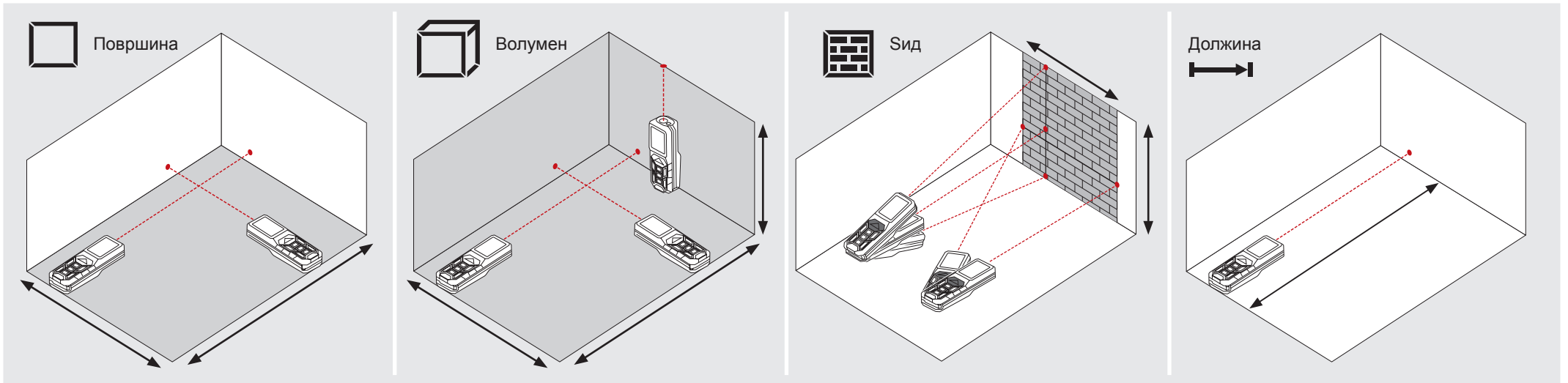

ЕДНОСТАВНО ДОЛЖИНСКО МЕРЕЊЕ

0

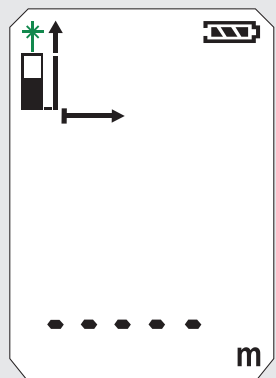

1

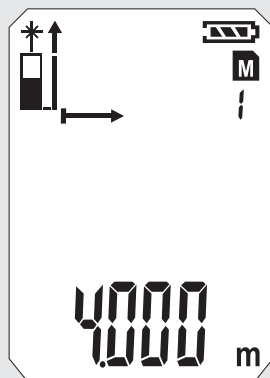
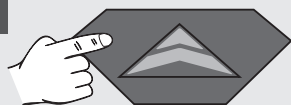

2

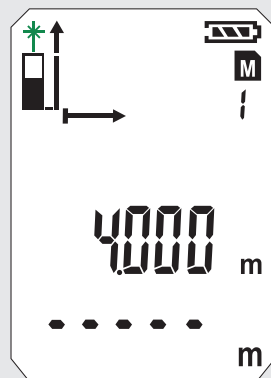
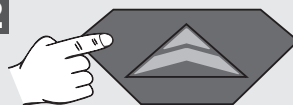

3

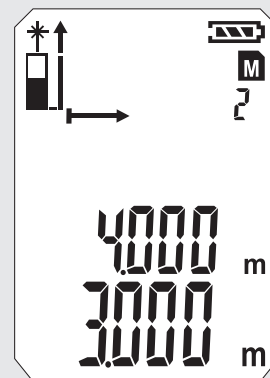
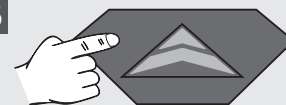

4

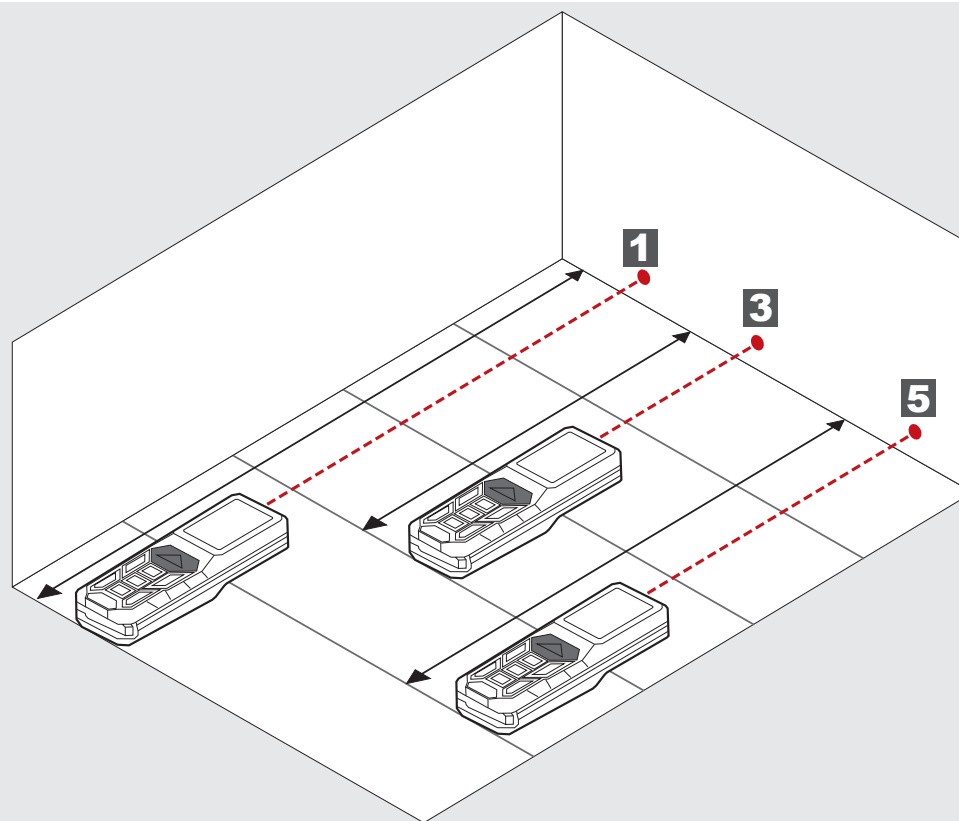
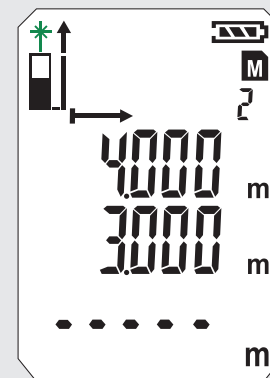
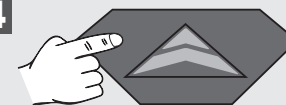

5

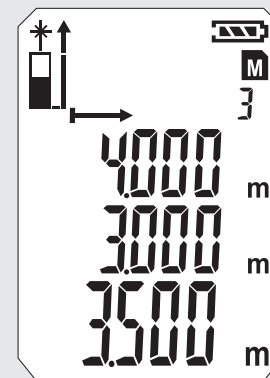
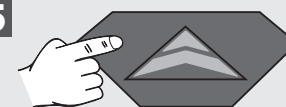

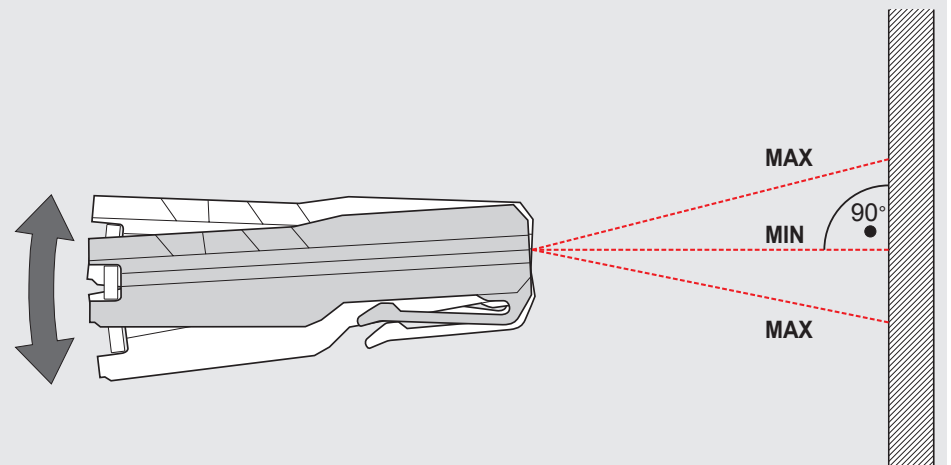
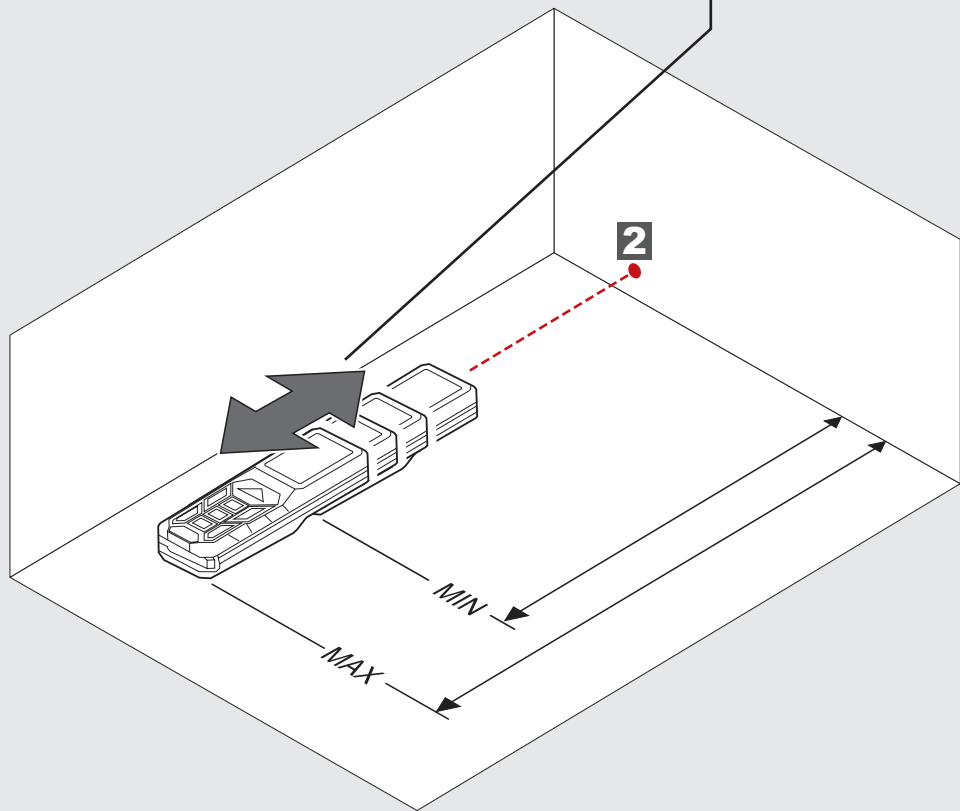
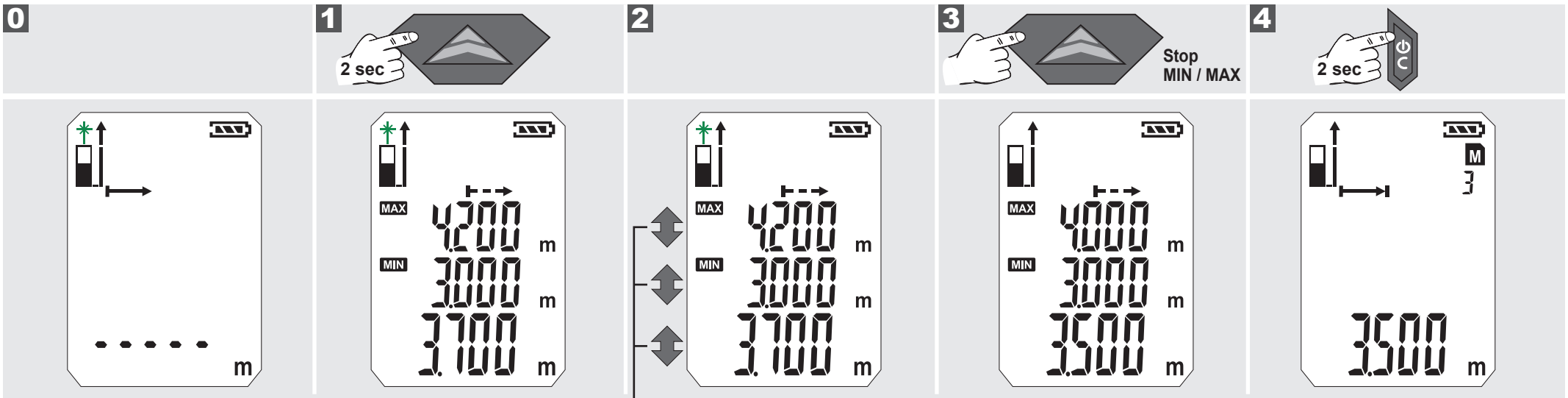

0

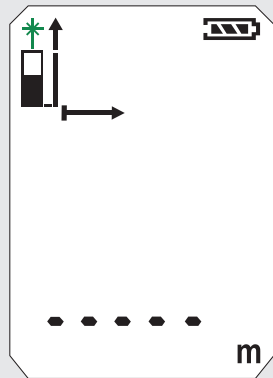

1

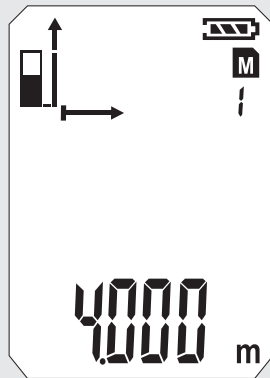
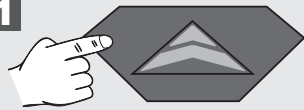

2

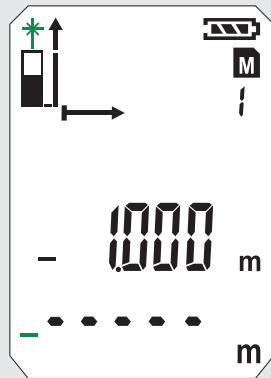
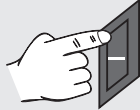

3

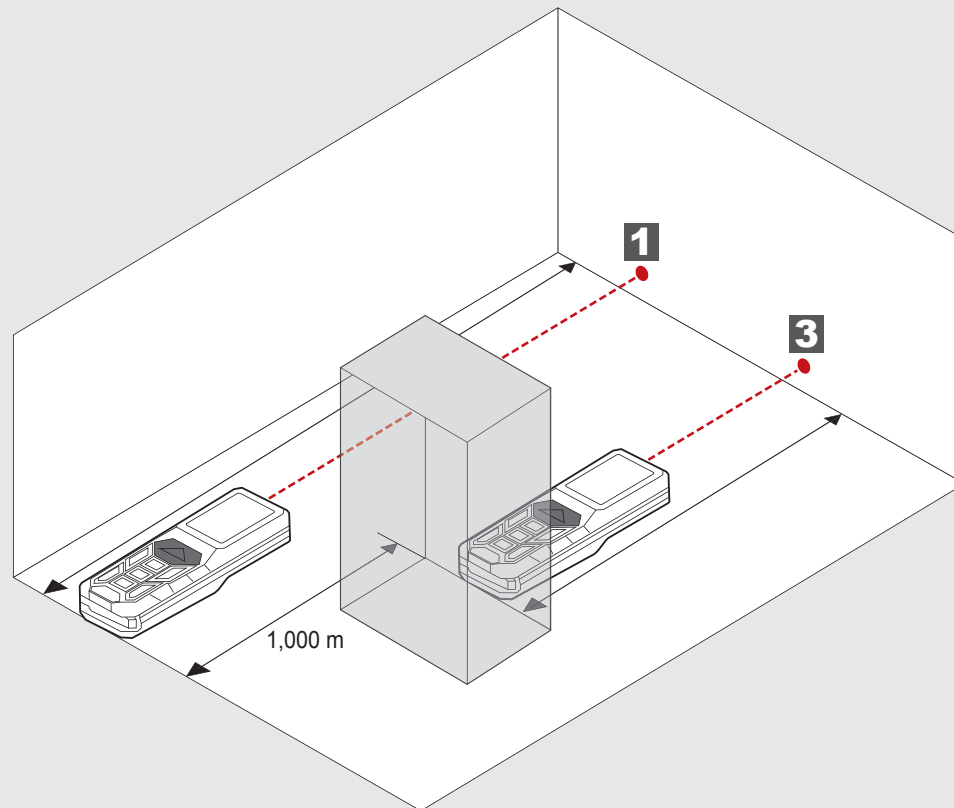
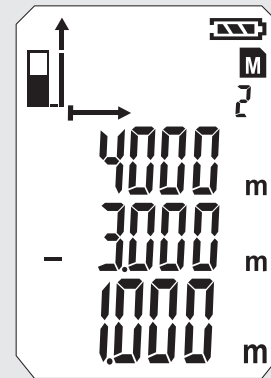
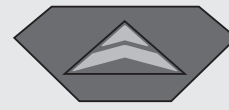

0



1

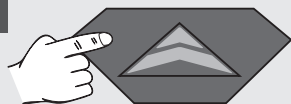

2

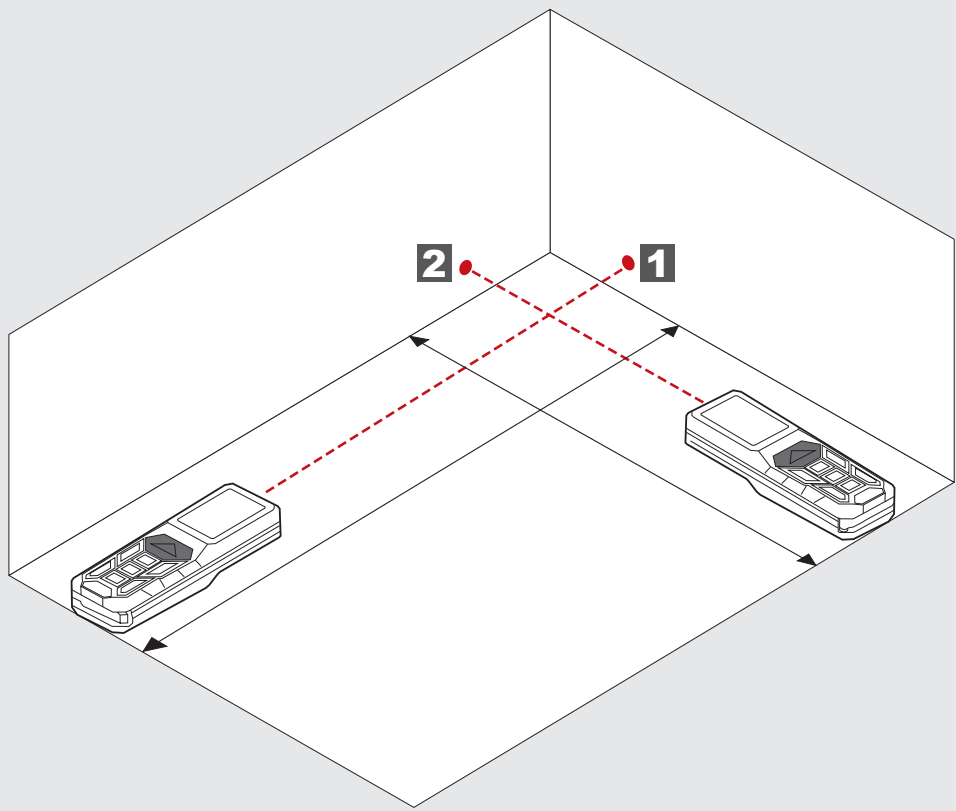
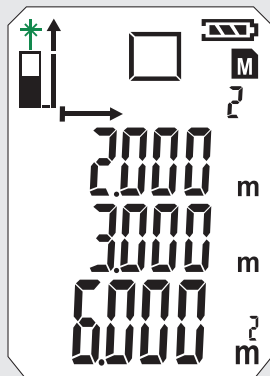
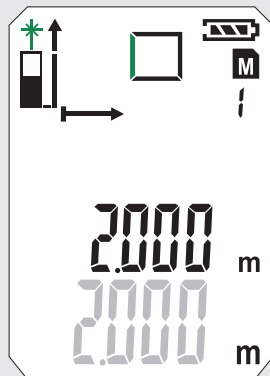
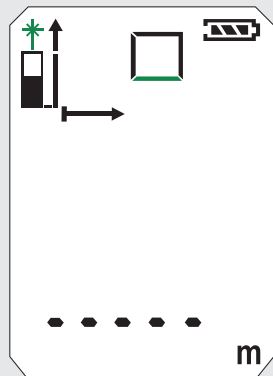
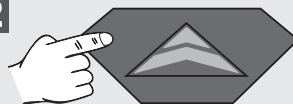

МЕРЕЊЕ НА ВОЛУМЕНОТ

0



1

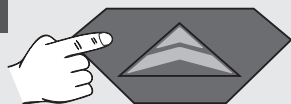

2

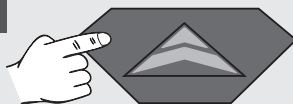

3

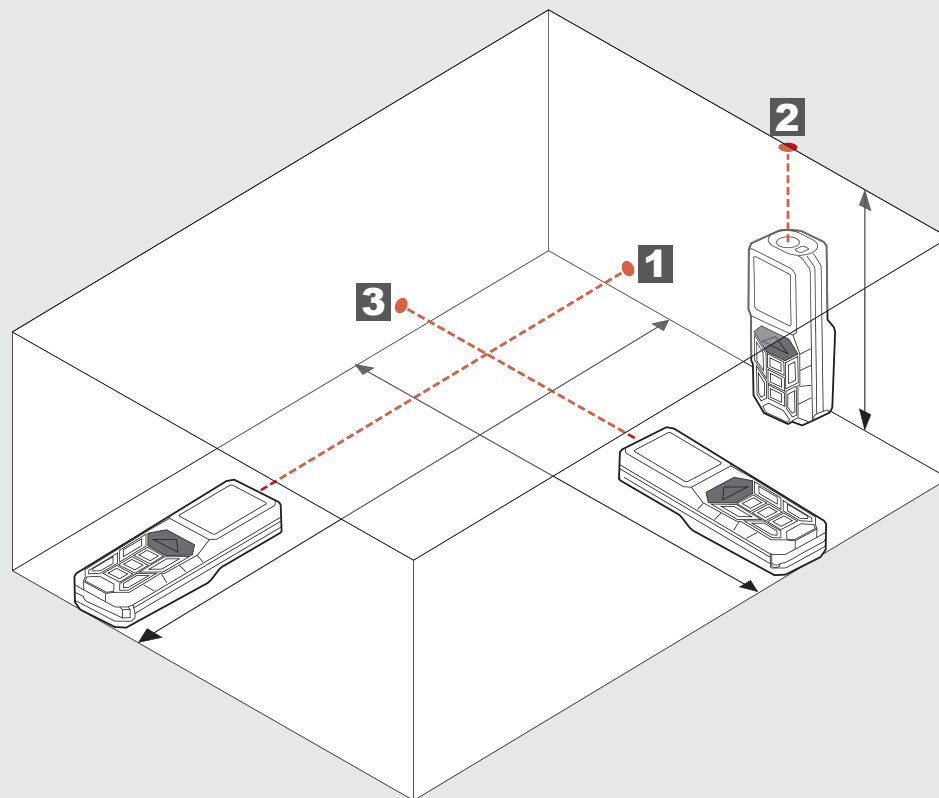
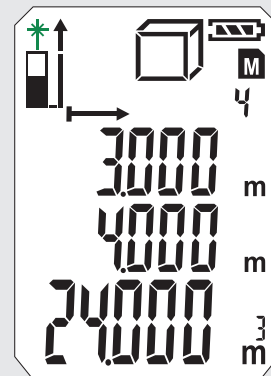
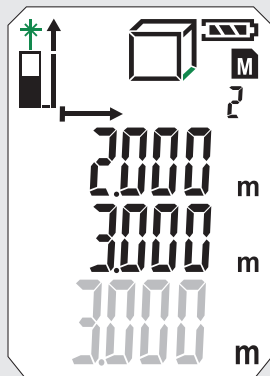
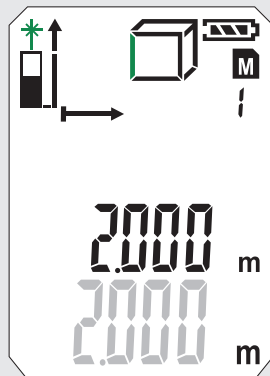
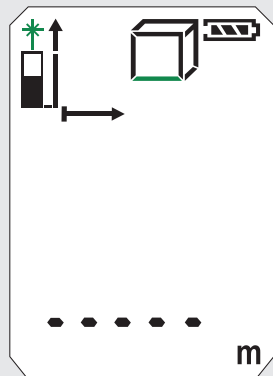
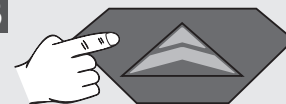

ИНДИРЕКТНО МЕРЕЊЕ (ПИТАГОРА 1)

0



1

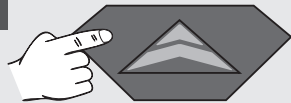

2

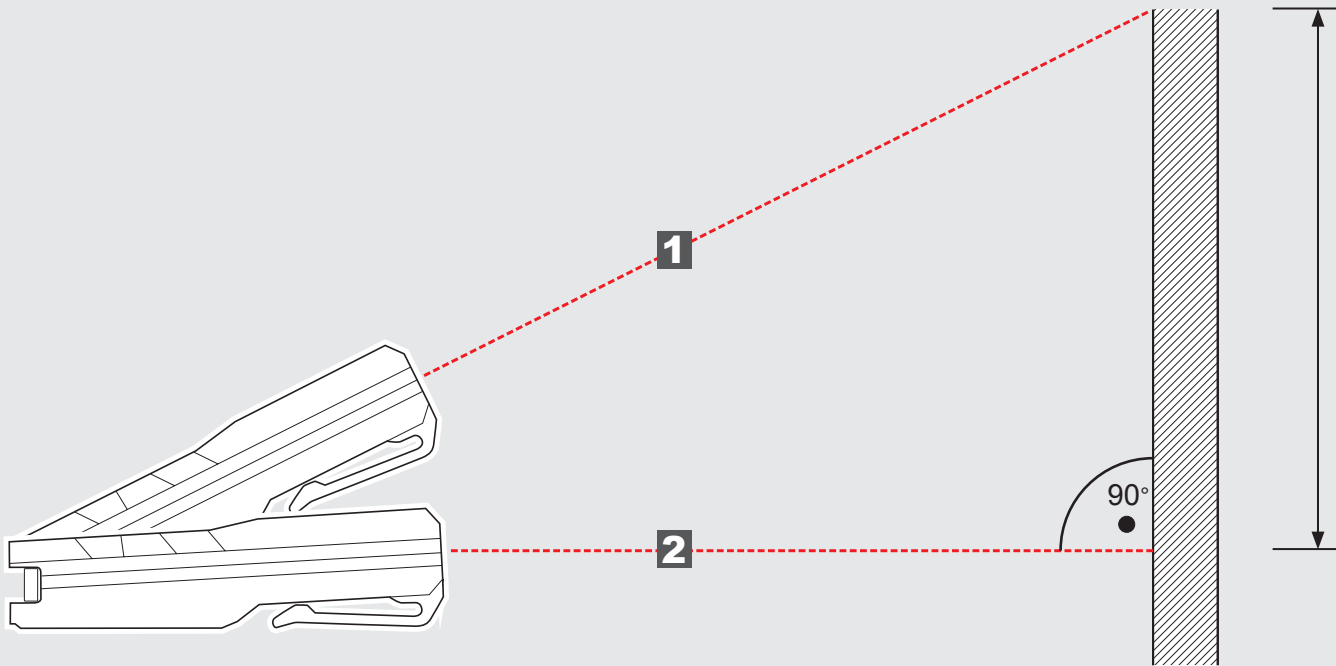
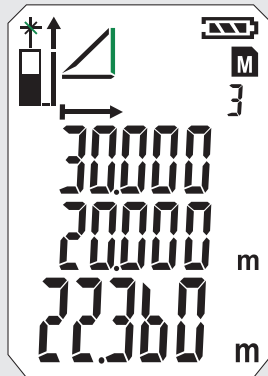
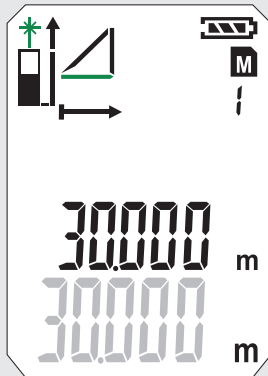
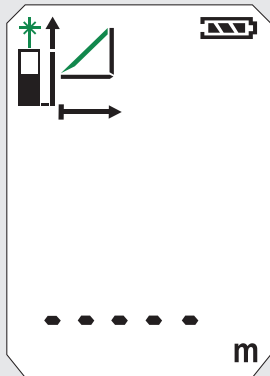
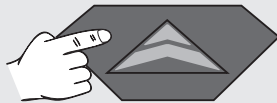

ИНДИРЕКТНО МЕРЕЊЕ (ПИТАГОРА 2)

0



1

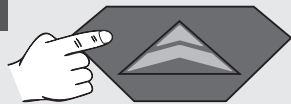

2

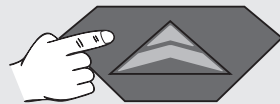

3

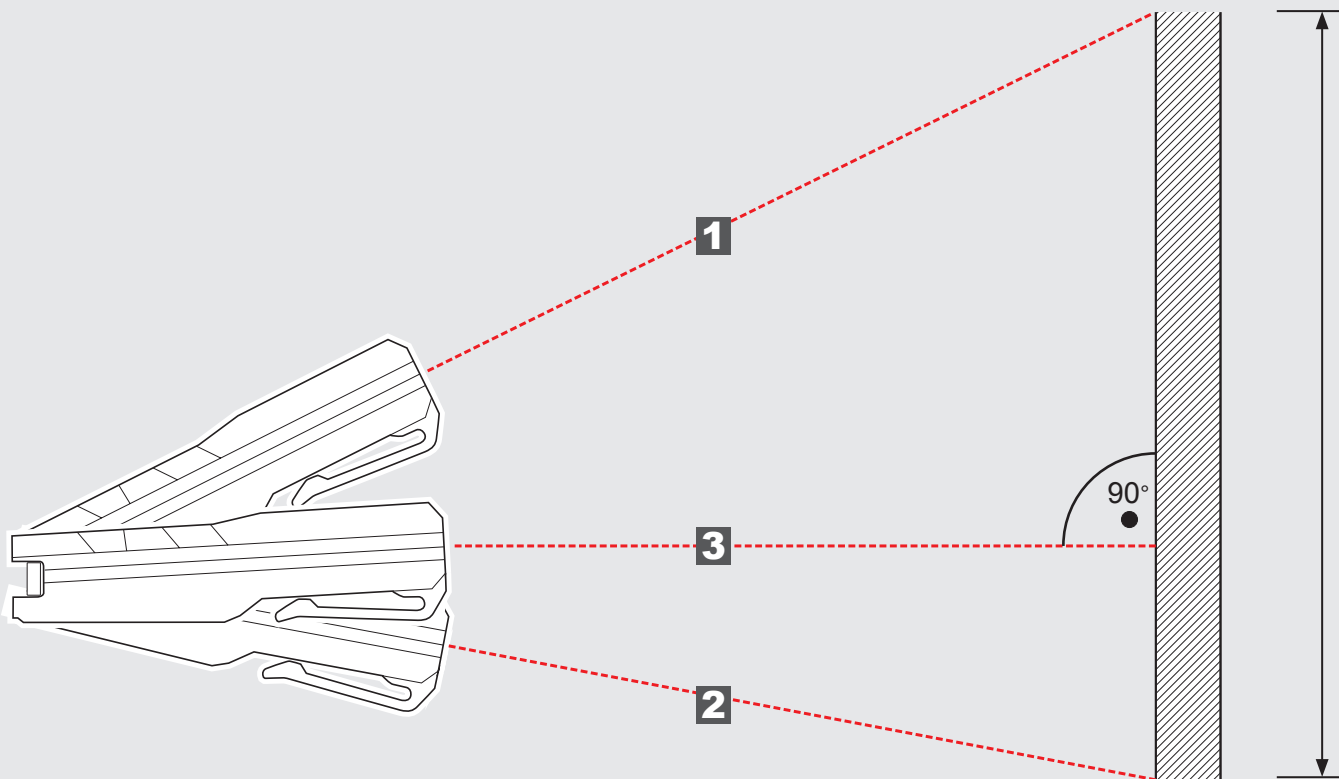
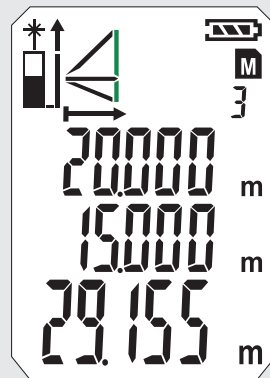
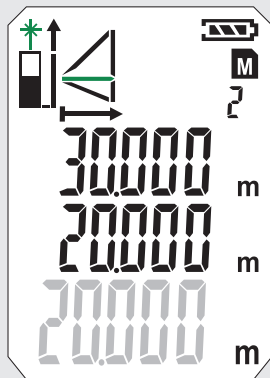
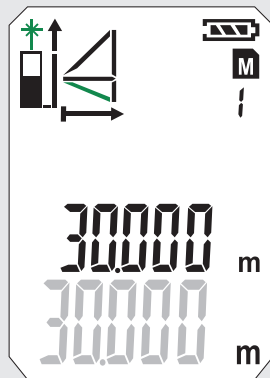
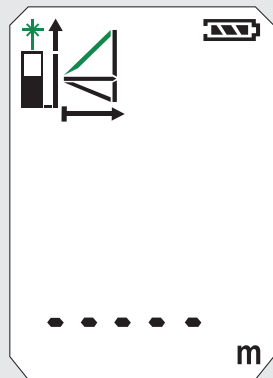
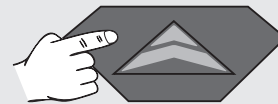

ИНДИРЕКТНО МЕРЕЊЕ (ПИТАГОРА 3)

1



2

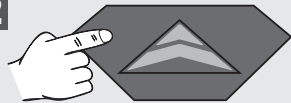

3

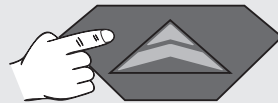

4

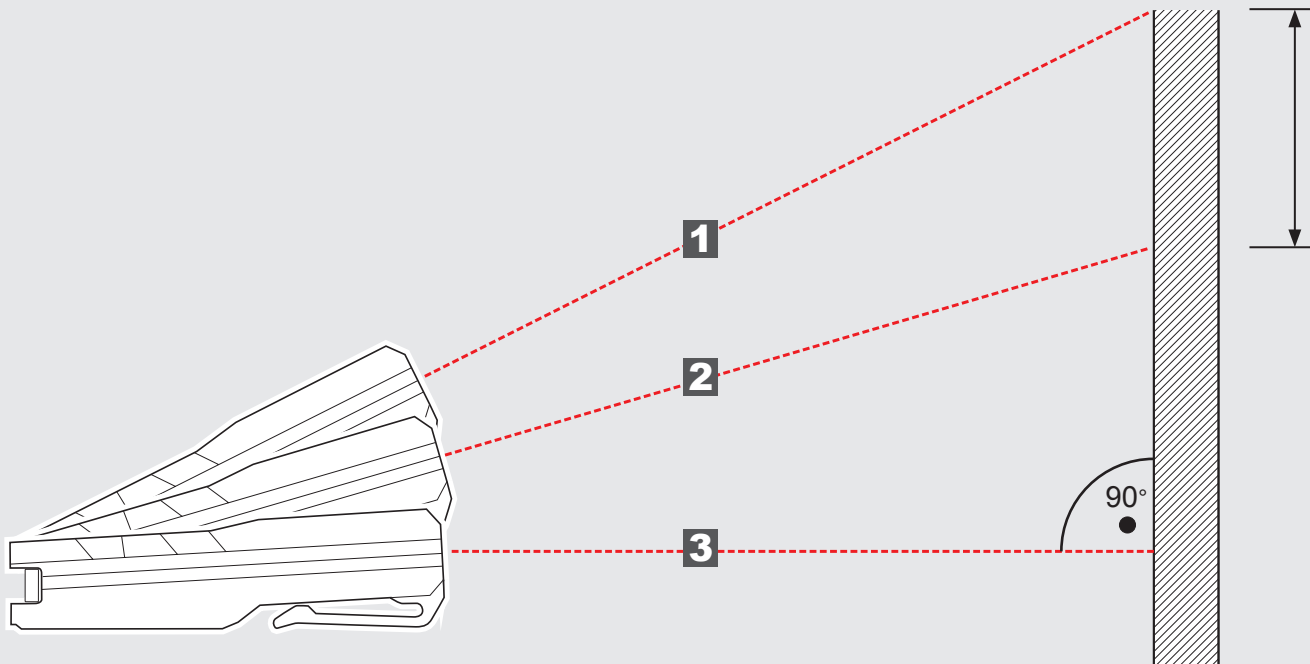
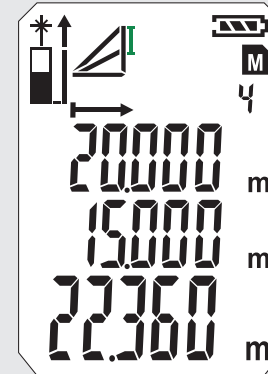
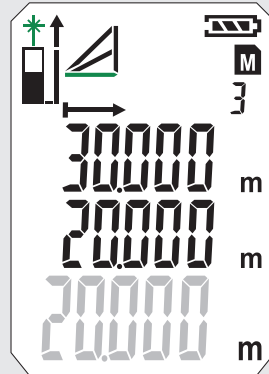
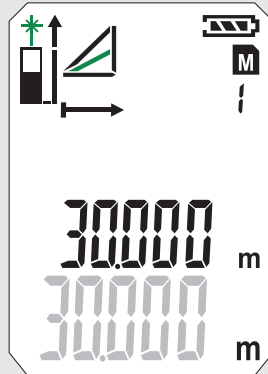
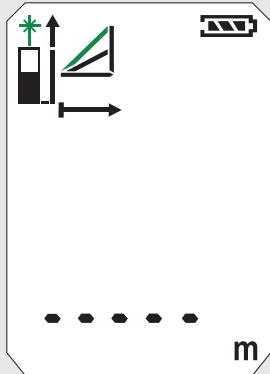
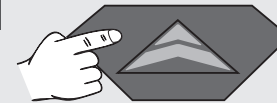





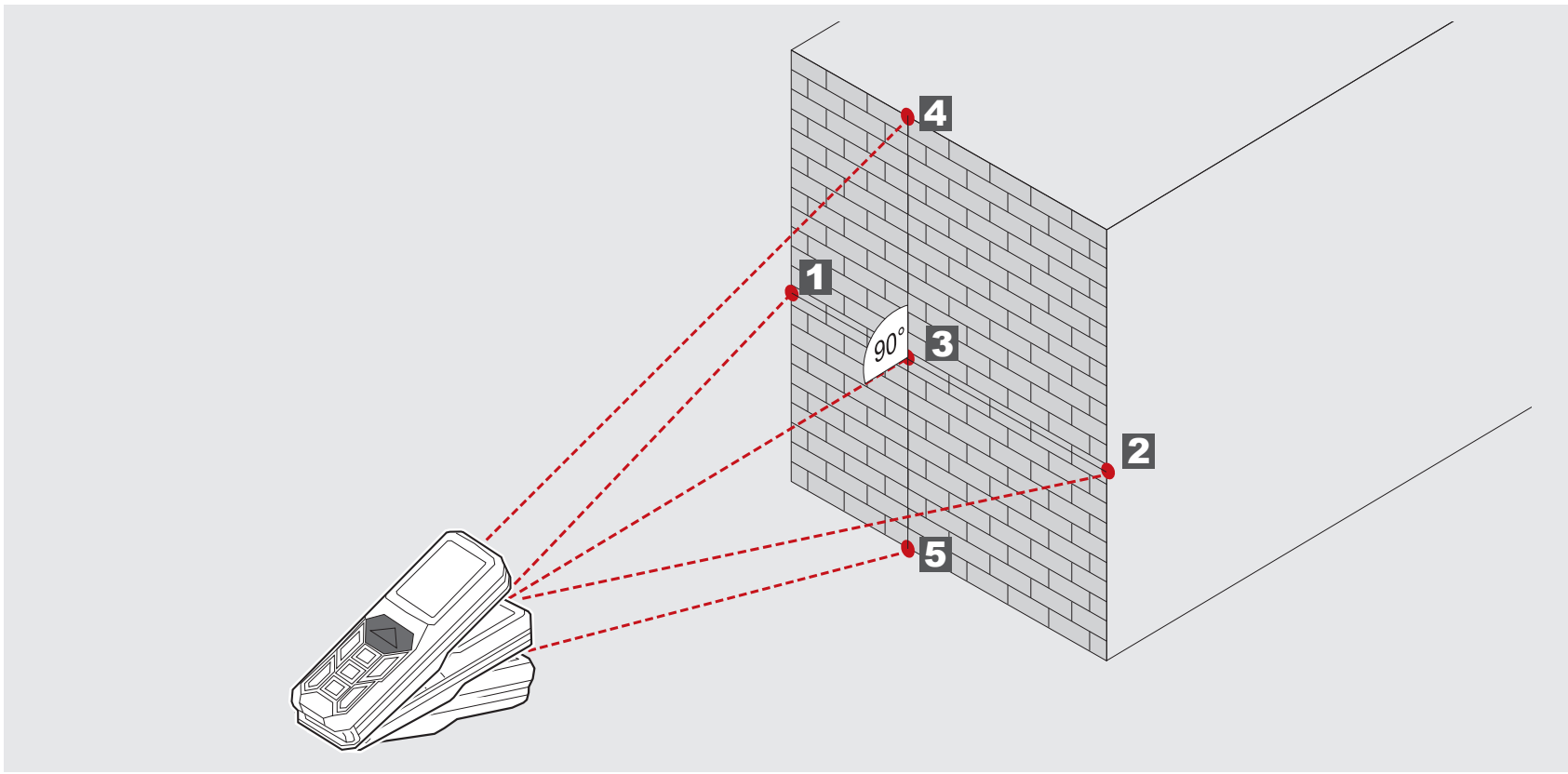







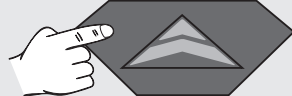
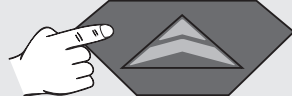



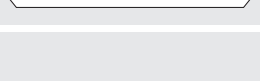

МЕРЕЊЕ НА ПОВРШИНАТА НА СИДОТ (СЦЕНАРИО 1)

0 	1 	2 	3 	4

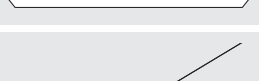

5

МЕРЕЊЕ НА ПОВРШИНАТА НА СИДОТ (СЦЕНАРИО 2)

0 	1 	2 	3 	4 
 	 	   	   	   

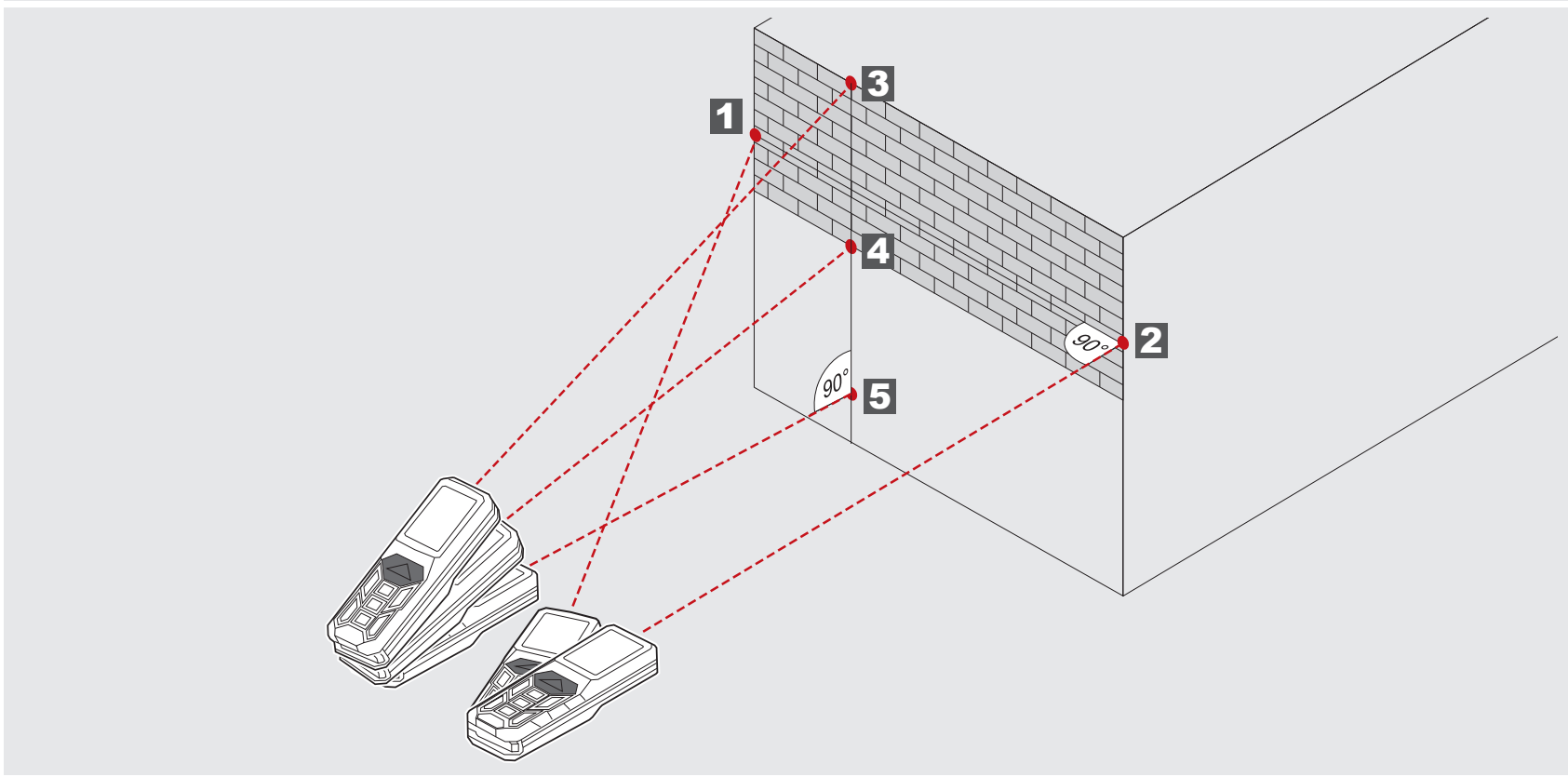

5



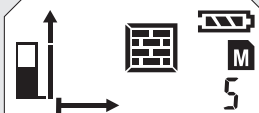









ТАЈМЕР

Со тајмерот, мерењето може да се активира со одложување, на пример за да се позиционира некој дел од апаратот во мерниот зрак.

Притиснете го копчето 

- Се појавува симболот 
Со притискање на копчето  тајмерот може да се подеси помеѓу 3 и 15 сек.

Притиснете го копчето 

- Секундите се бројат надолу до мерењето.
- Кај 0 се активира мерењето.

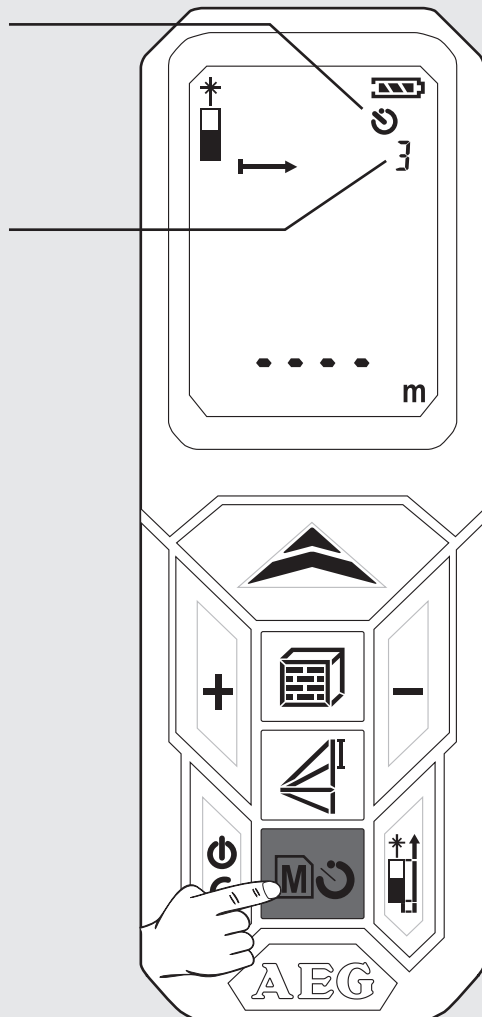

МЕМОРИЈА

Мерните вредности се снимаат автоматски и редоследно во меморијата.

Меморираните вредности можат да се повикаат со копчето .

Притиснете го копчето 
цели 2 сек.

- Се појавуваат симболот и местото на меморирање.
- Се прикажува конкретната мерна големина.
- Меморираната вредност се прикажува во главната ќелија.
- Навигирајте со копчињата +/-

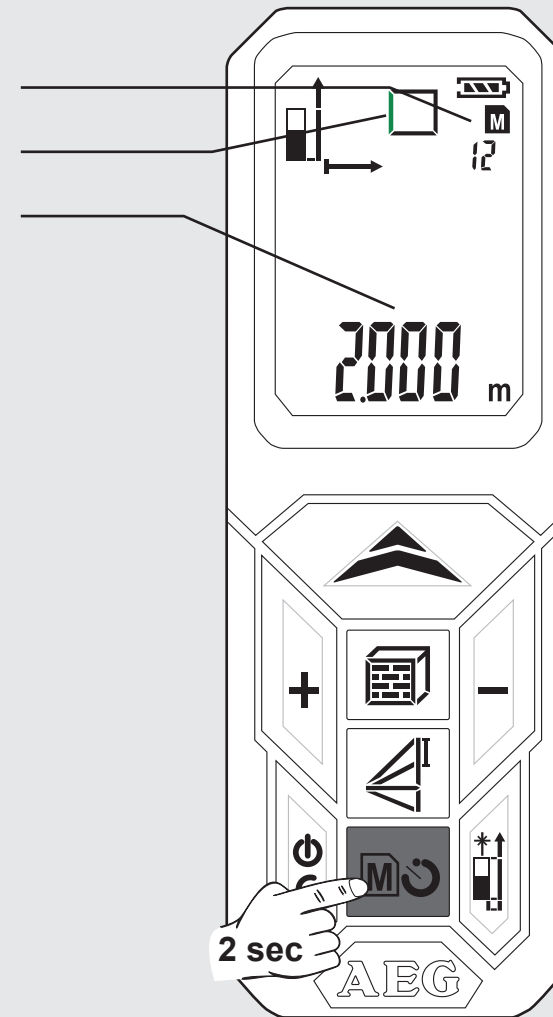

ОСНОВНИ НАЧИНИ НА ФУНКЦИОНИРАЊЕ СО ПРИМЕРОТ НА ПОВРШИНСКО МЕРЕЊЕ (1)

1 Вклучување



Притиснете го копчето .

⚠ Внимание! Лазерскиот зрак е вклучен!

Не го усмерувајте према други лица!

2 Изберете мерно ниво

Стандардно подесување после вклучувањето: позади

-  1x притисни -> игличка за агли
-  2x притисни -> напред
-  3x притисни -> позади

3 Избери функција

После вклучувањето апаратот секогаш стои на должинското мерење.

-  1x притисни - површинско мерење

4 Мерење на должината

Апаратот се центрира и се притиска копчето .

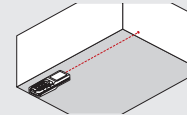

5 Мерење на ширината

Апаратот се центрира и се притиска копчето .

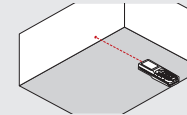

Лазерскиот симбол трепка (трепкањето е прикажано зелено).

Се прикажува симболот

- Се појавува симболот
- Мерната големина трепка (трепкањето е претставено зелено)

- Мерната вредност кратко време се покажува во главната ќелија.
- Мерната вредност после 1 сек преминува една ќелија погоре.
- Мерната вредност се снима во меморијата со редоследен број.
- Втората мерна големина трепка.
- Апаратот е спремен за мерење на втората вредност.

- Мерната вредност кратко време се појавува во главната ќелија.
- Мерната вредност после 1 сек преминува една ќелија погоре.
- Мерната вредност се снима во меморијата со редоследен број.
- Резултатот се прикажува во главната ќелија и се снима во меморијата под редоследен број.

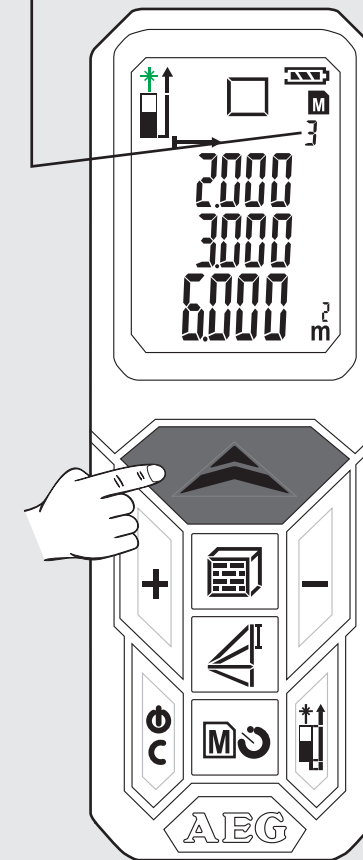
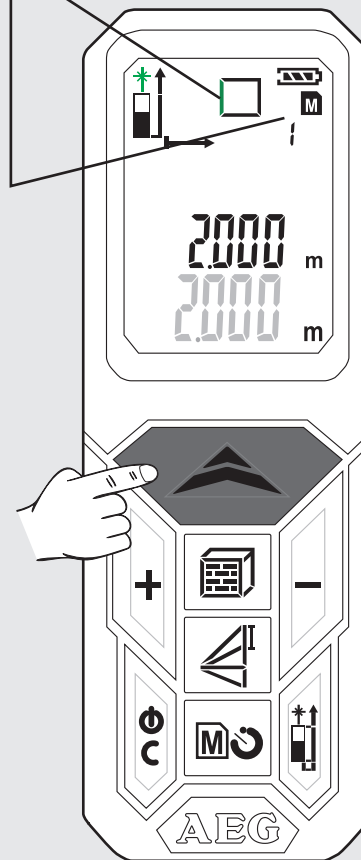
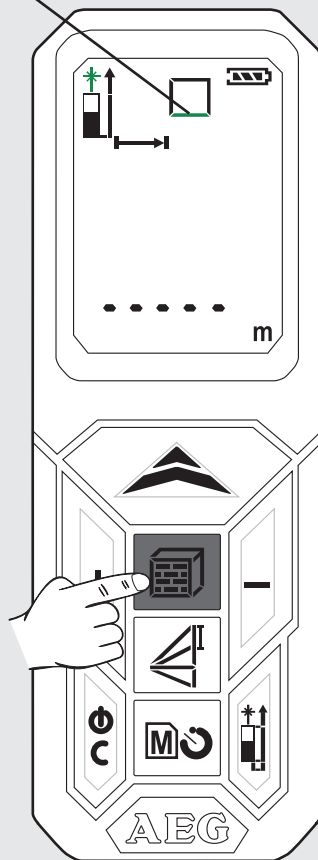
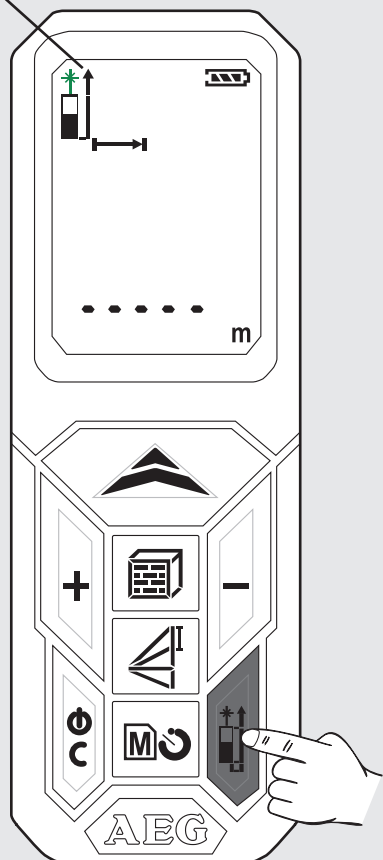
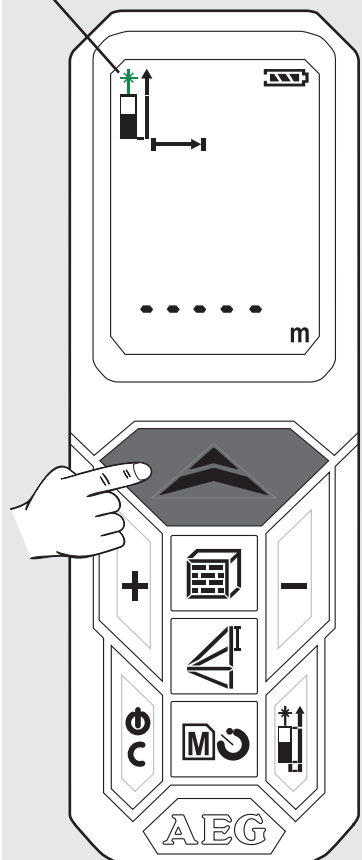

ОСНОВЕН НАЧИН НА ФУНКЦИОНИРАЊЕ СО ПРИМЕРОТ НА ПОВРШИНСКО МЕРЕЊЕ (2)

6 Повикување на сниманите вредности

2 сек притискајте го копчето .
Притиснете го копчето + или -

7 Напуштање на меморијата

Притиснете го копчето .

8 Исклучување

2 сек притискајте го копчето 
(Претходно мора да се напушти меморијата).

- Меморираните вредности се прикажуваат во главната ќелија
Конкретниот симбол се прикажува и мерната големина трепка (трепкањето е претставено зелено).

- Апаратот се исклучува.
- Ако во текот на 3 минути не биде притиснато ниту едно копче, апаратот автоматски се исклучува.

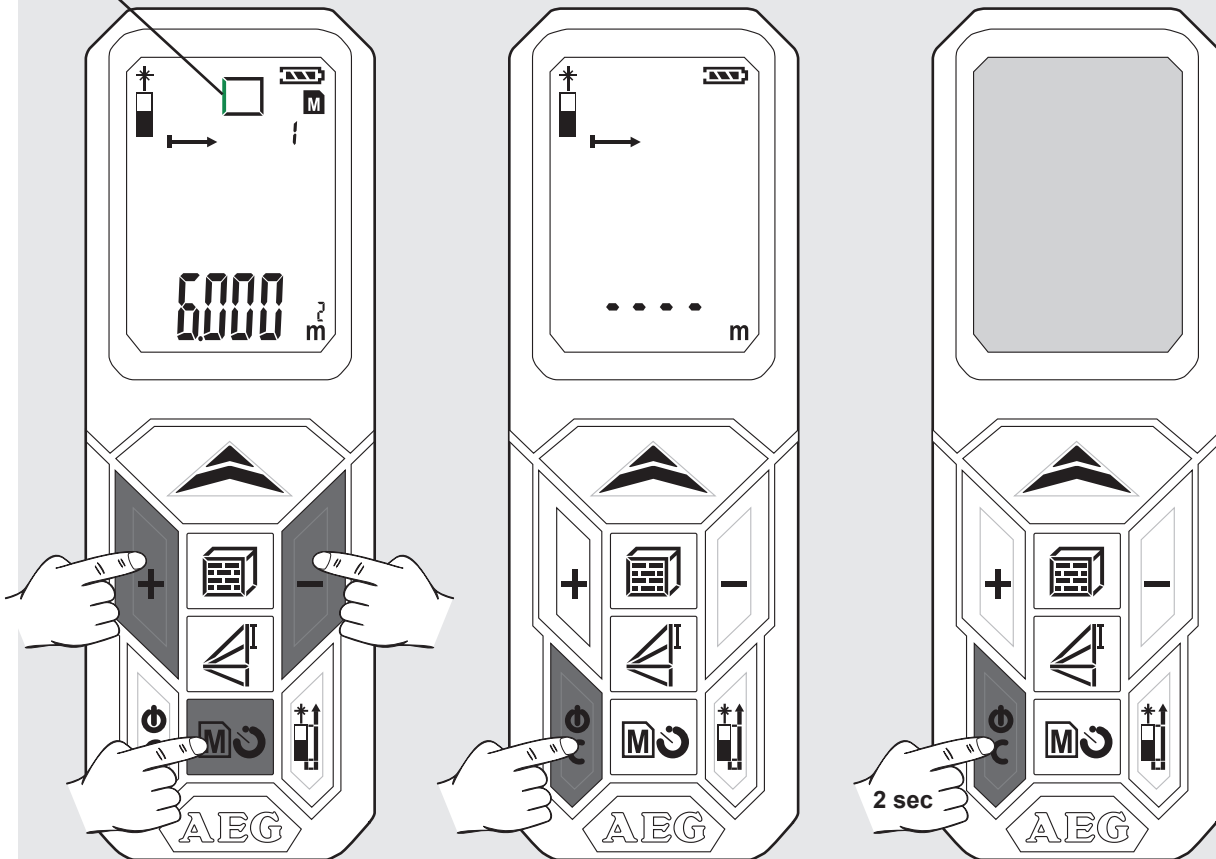

内容

重要安全提示.....	1
技术数据.....	2
正确地使用机器.....	2
错误代码表.....	2
概览.....	3
更换电池.....	4
边角定位.....	4
皮带扣.....	4
功能按键，毕达哥拉斯，测量平面.....	5
普通长度测量.....	6
连续测量/最高最低值测量.....	7
加法/减法测量.....	8
面积测量.....	9
体积测量.....	10
间接测量（毕达哥拉斯1）.....	11
间接测量（毕达哥拉斯2）.....	12
间接测量（毕达哥拉斯3）.....	13
墙面积测量（用例1）.....	14
墙面积测量（用例2）.....	15
倒计时器.....	16
内存.....	16
按面积测量的例子说明基本工作原理（1）.....	17
按面积测量的例子说明基本工作原理（2）.....	18

重要安全提示



阅读附加提供光碟上的安全提示和操作说明书后，才可以开始使用此产品。

激光分类

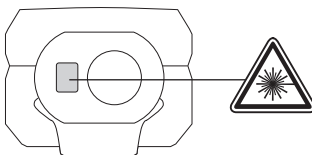

警告：

依照EN60825-1:2007，此产品符合2级激光。



标记

最初操作前请将附送的贵国语言贴纸贴到英文铭牌上。

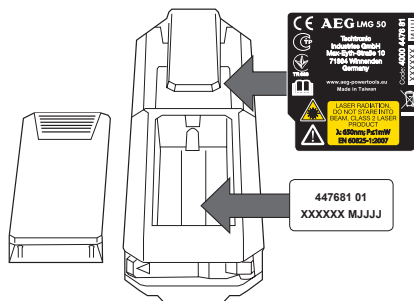

警告：

由于激光光束会导致暂时闪光盲，必须避免直视激光光束。

切勿注视激光光束或无必要而把光束指向别人。

切勿向别人发出耀眼光束。

警告！

严禁在儿童附近操作激光机器或让儿童操作此激光机器。

注意！反射面可能会把激光束向操作者或其他人员反映。

确保跟活动部件的相应安全距离。

请定期进行测试性测量，尤其进行重要测量前、中、后。

产品掉落、进行不允许操作或产品改造后，请注意缺陷产品引起的测量错误。

注意！请仔细地阅读下列指示以了解机器的操作元件和其正确使用。

此激光测量仪的操作范围有限制。（请见“技术数据”）。在最大或最小测量范围之外尝试进行测量会引起不正确的测量。把仪器用在太热、太冷、日光太亮、下雨、下雪、雾气等不良或限制目光条件下，会引起不正确的测量。

如果把激光测量仪从温暖环境移到寒冷的环境（或相反），应等待到仪器适应新的环境温度。

激光测量仪必须室内保存并确保仪器不会受到震动、震荡或极端温度的影响。

必须确保仪器免受粉尘、潮湿或高空气湿度侵入以避免仪器的内部器件被损害或测量精度受到不良影响。

不要使用腐蚀性清洁剂或溶剂。只要使用干净软布清洁仪器。

必须避免光机测量仪遭受强烈撞击或掉落。仪器掉落或遭受其他机械荷载后，应检查仪器的测量精度。

此激光机器上所需修理工作必须由授权专业人员进行。

切勿在有爆炸危险或腐蚀性环境条件下使用产品。

务必只通过制造者推荐的充电器向蓄电池充电。

严禁将废电池与生活垃圾一起弃置。保护环境，根据国家或地方法规将废电池弃置在指定的垃圾收集站。本产品不可与生活垃圾一同回收处理。根据您所在国家/地区实施的法规，恰当地弃置本产品。遵守国家或当地相关规定。有关正确回收处理，请咨询主管地方当局或购买机器的商店。



技术数据

保护等级	IP54 (粉尘和喷水保护)
光学接收镜头	14mm
焦点	35mm
最大测量范围	50米(公差:55m)
最小测量范围	0,05米
绝对精度@<10m	±1,5mm(最大)
重复精度@<10m	±1,5mm(标准最大2σ)
重复精度@ > 10m	升高±0,25mm/米(标准最大2σ)
测量时间	0,5s
显示器型式	LCD(22,7mmx31mm)
供电	AAA2x(碱性电池)
电池寿命	10000(单位:测量)
激光机输出功率	0,6mW~0,95mW(2级,650nm)
激光光斑尺寸	25x30mm@16m(最大)
激光光束垂直角	+1度
激光光束水平角	±1度
自动仪器关闭	180秒
自动激光关闭	30秒
工作温度范围	-10°C至+50°C
储存温度范围	-25°C至+70°C
无电池重量	80g

正确地使用机器

此激光测量仪适用于测量距离和倾斜度。

请依照本说明书的指示使用此机器。

错误代码表

代码	说明	解决
Err01	测量范围以外	测量范围之内进行测量。
Err02	被反应的信号太弱	选择较好的表面。
Err03	显示范围之外(最大数值为99,999)比如面积或体积在显示范围之外	检查数值和步骤是否正确。
Err04	毕达哥拉斯计算有错误	检查数值和步骤是否正确。
Err05	电池过弱	装进新电池。
Err06	工作温度范围之外	规定工作温度范围之内进行测量。
Err07	环境光太亮	变暗目标区域。

毕达哥拉斯
高度差

测量平面

长度测量

连续测量最低/最高值

加法/减法

开/测量

- ▶ 开
- ▶ 测量
- ▶ 连续测量 (按2秒)
最低/最高功能

加法

- ▶ 加数值
- ▶ 内存导航

面积/体积

- ▶ 面积 (按1次)
- ▶ 体积 (按2次)
- ▶ 间接面积测量 (按3次/4次)

接通

- ▶ 开
- ▶ 闭 (按2秒)
- ▶ 恢复

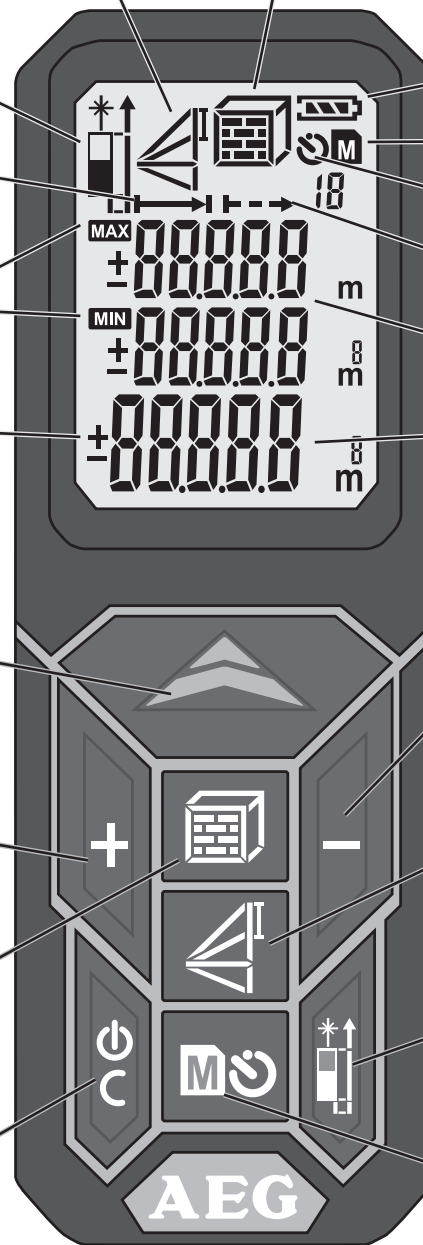

面积/体积
间接测量

电池状态

内存

倒计时器

连续测量

中间值

总值

减法

- ▶ 减数值
- ▶ 内存导航

毕大哥拉斯

- ▶ 毕大哥拉斯1 (按1次)
- ▶ 毕大哥拉斯2 (按2次)
- ▶ 毕大哥拉斯3 (按3次)

更改测量平面

- ▶ 前面
- ▶ 后面
- ▶ 边角定位

内存

- ▶ 倒计时器3-15秒 (按1次)
- ▶ 内存1-20 (按1次2秒)
- ▶ 通过+/-键导航内存

更换电池

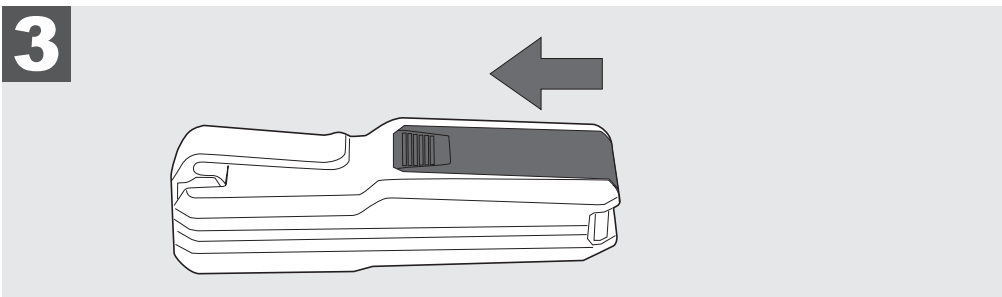
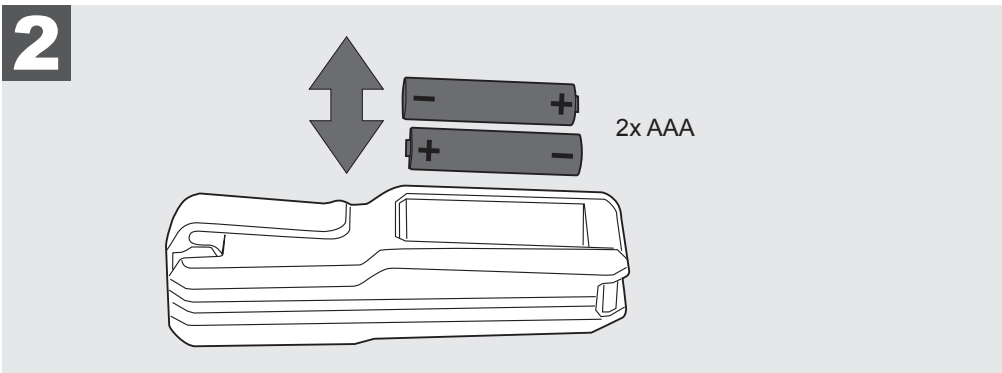
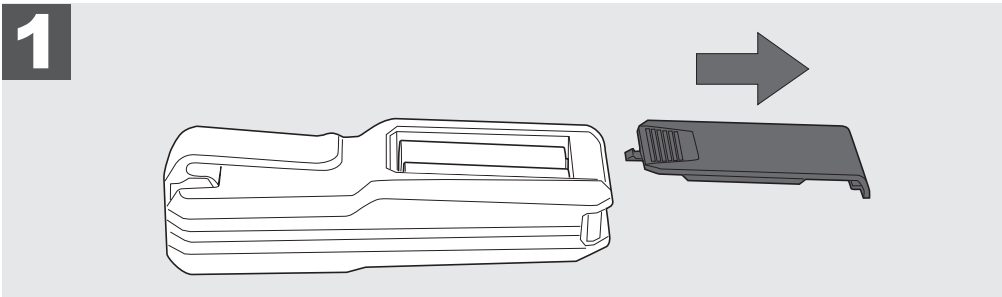
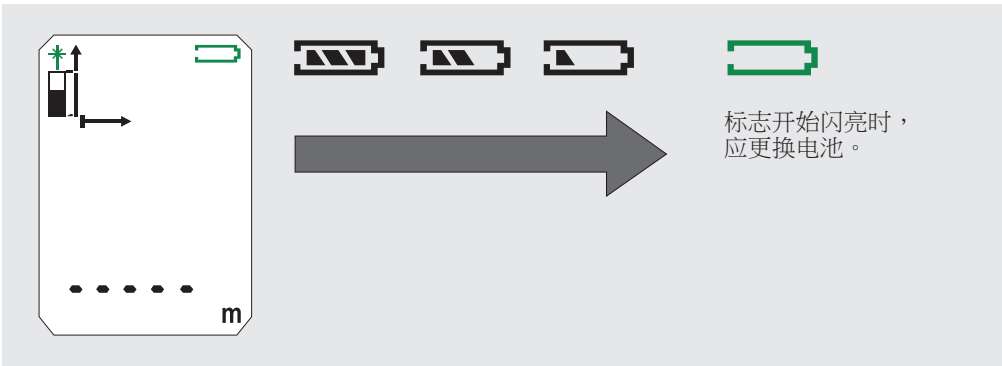

边角定位

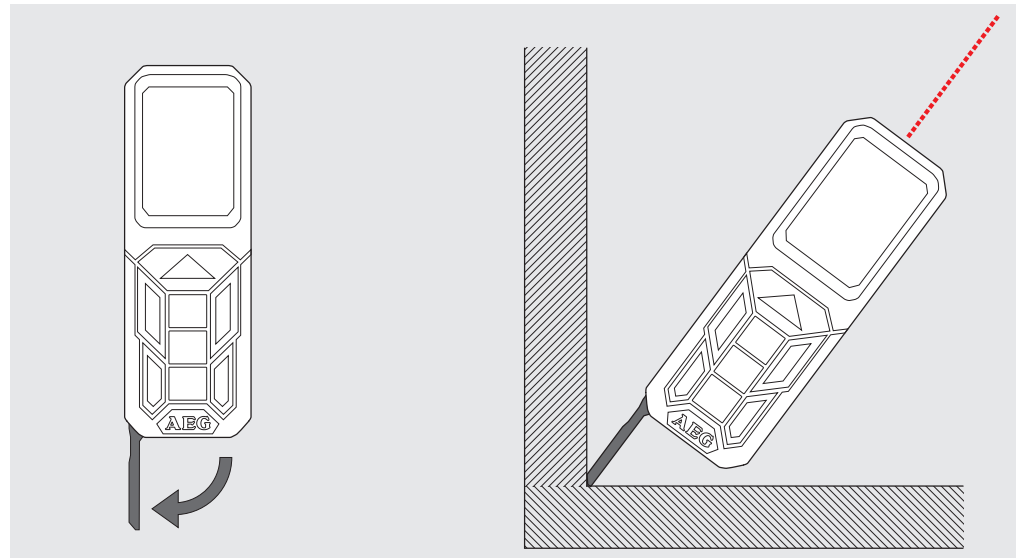

皮带扣

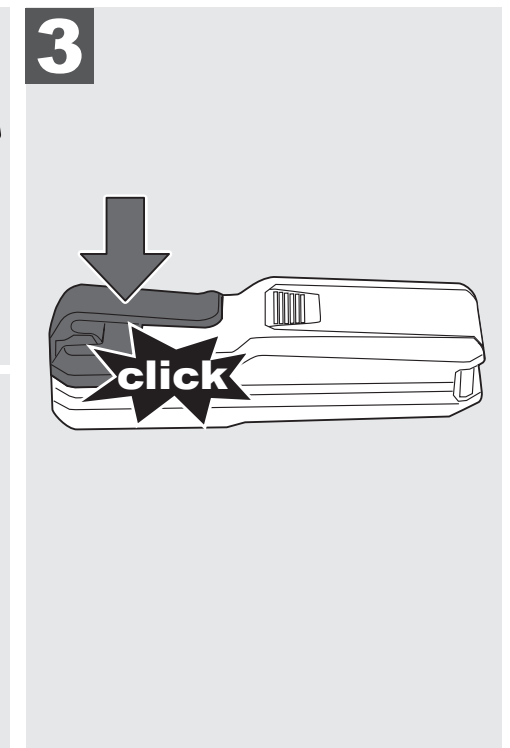
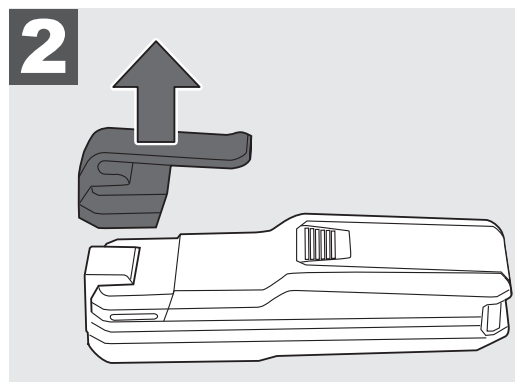
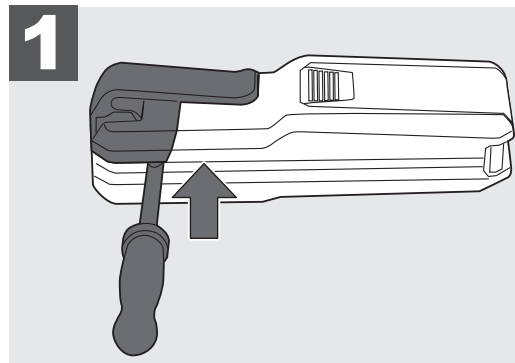

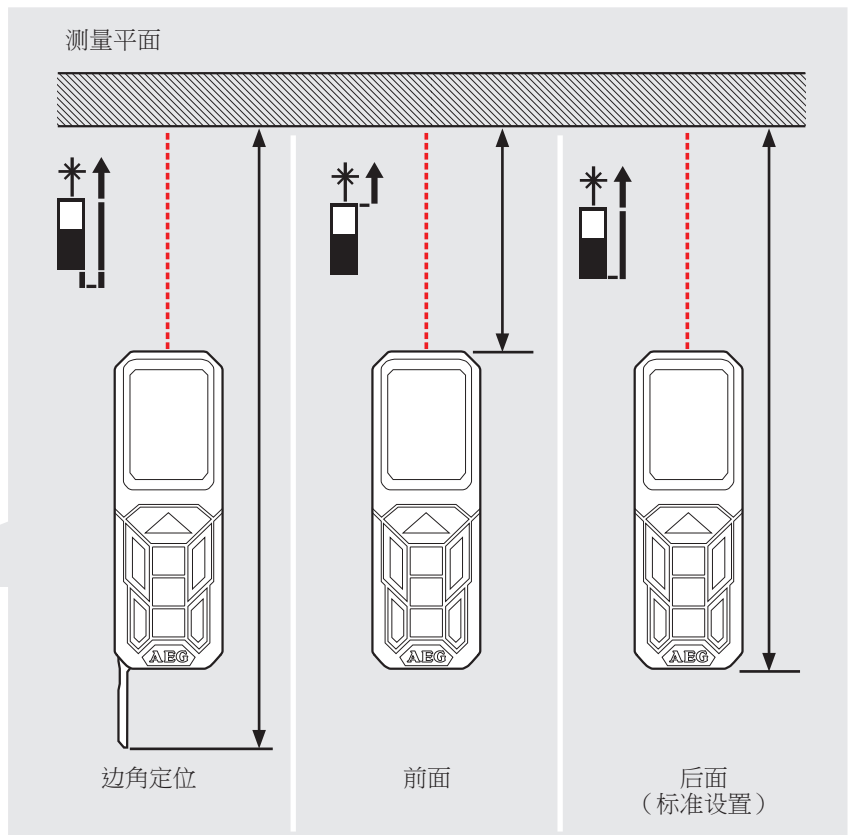
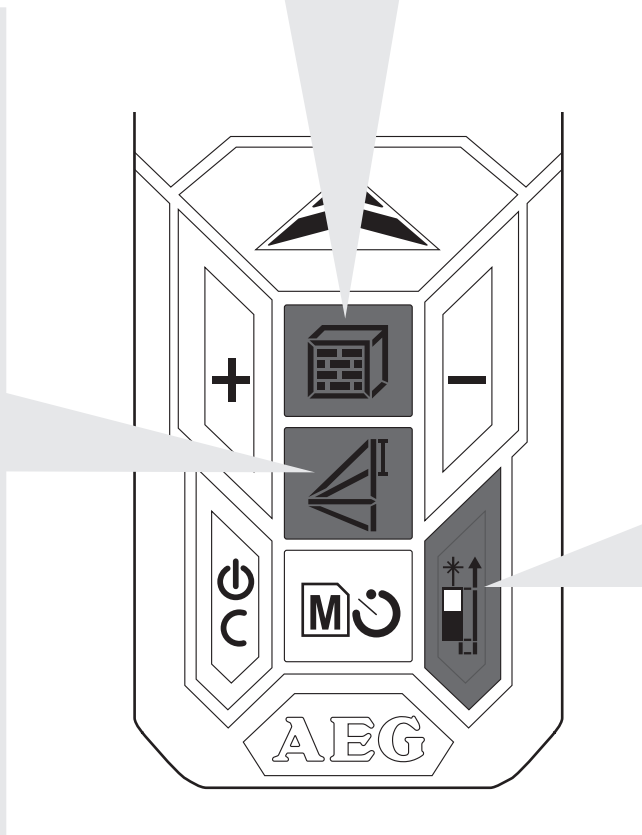
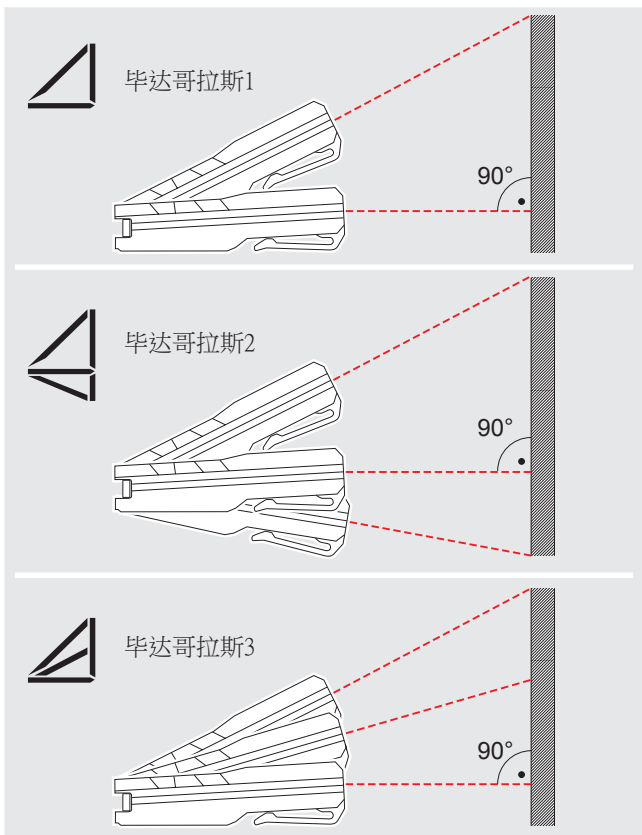
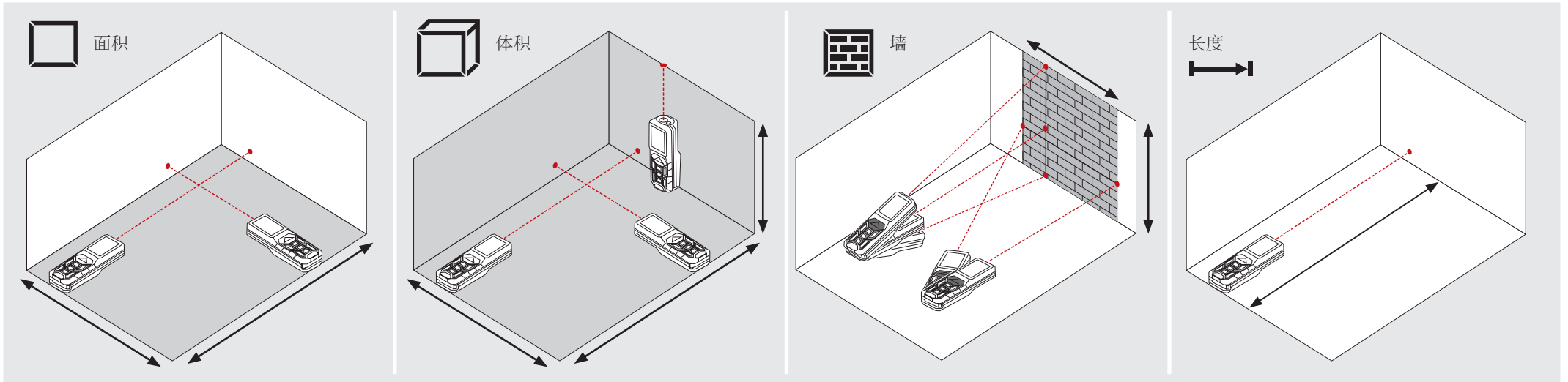

0

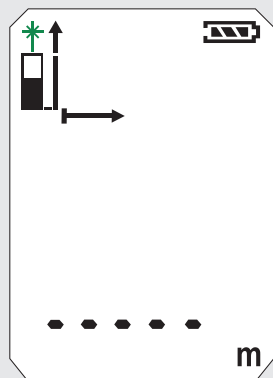

1

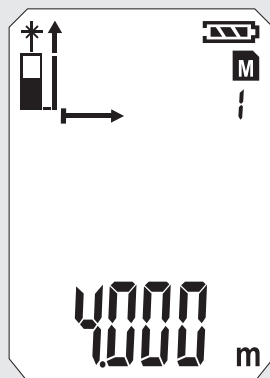
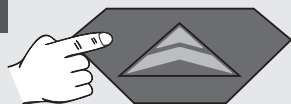

2

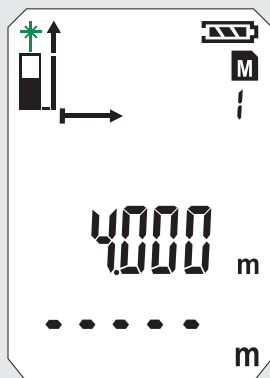
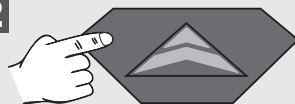

3

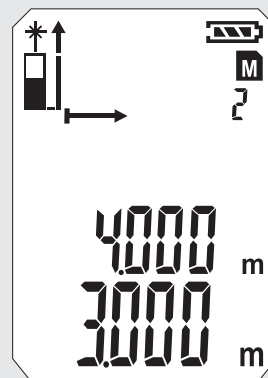
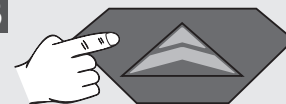

4

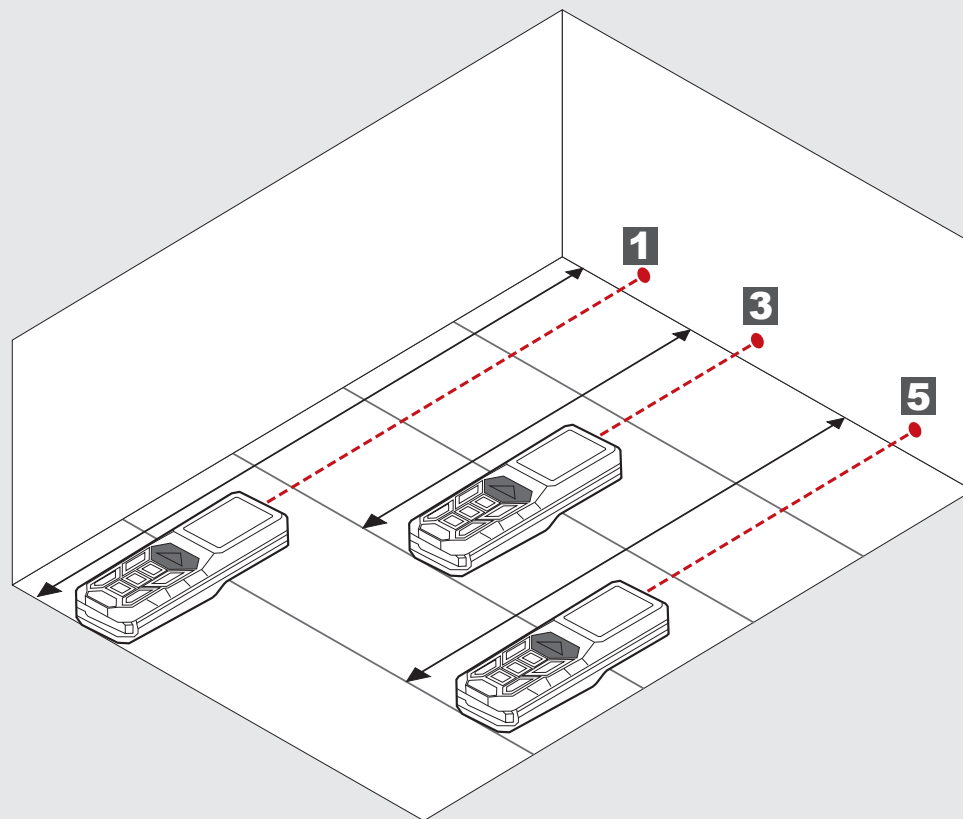
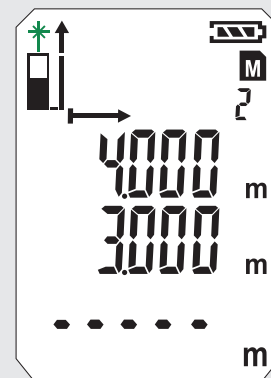
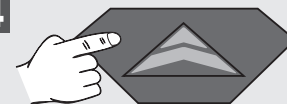

5

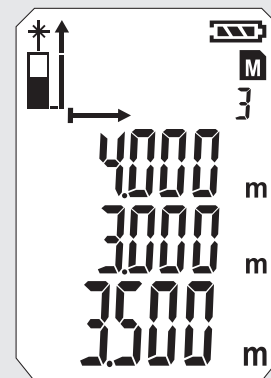
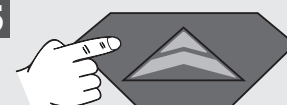

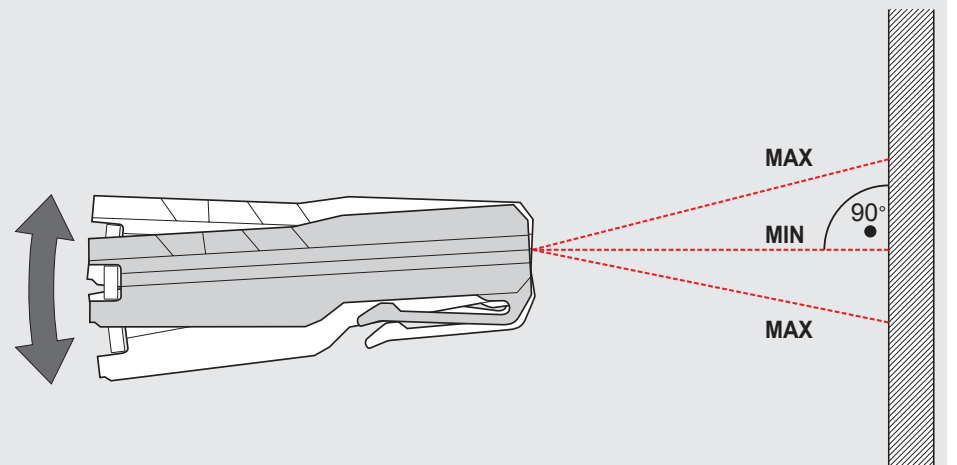
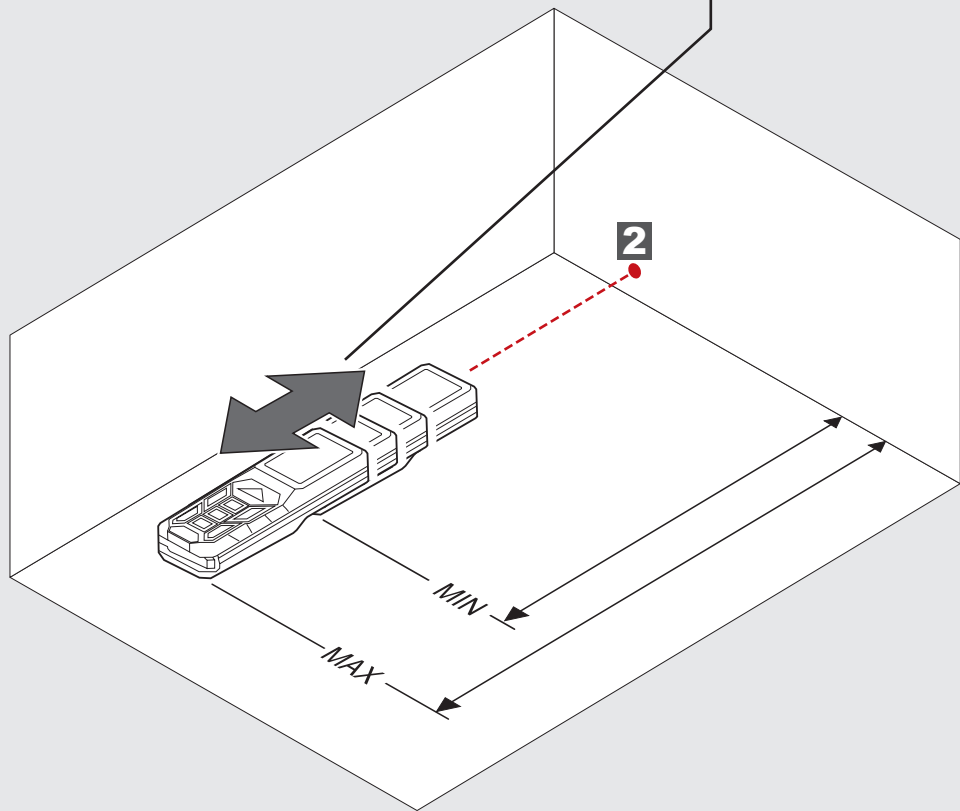
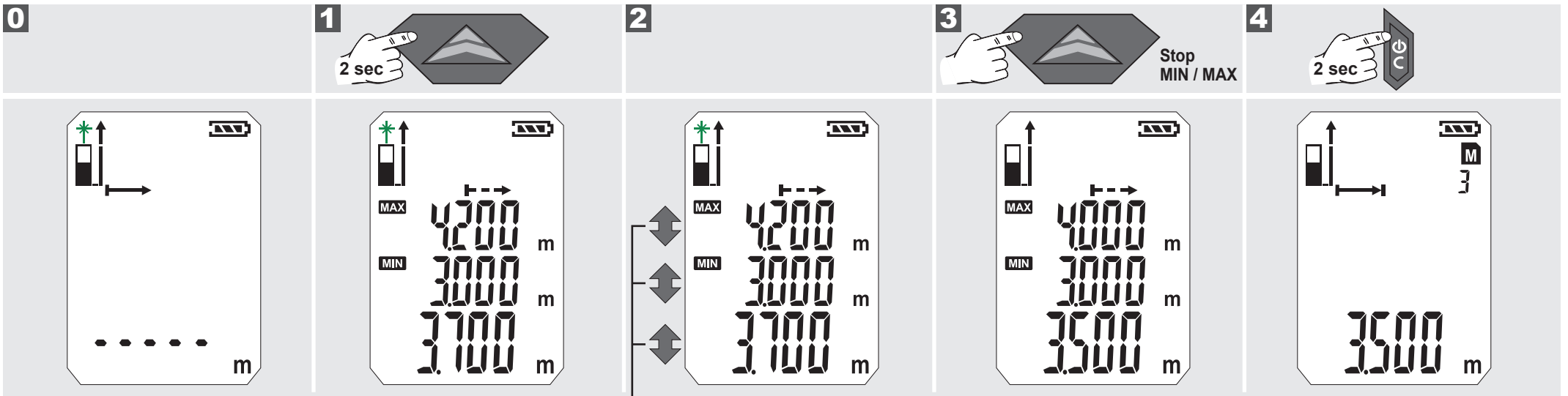

0

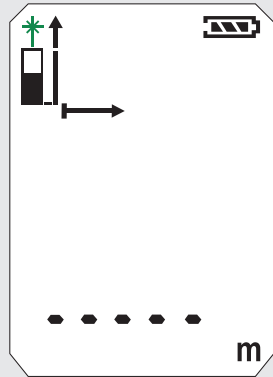

1

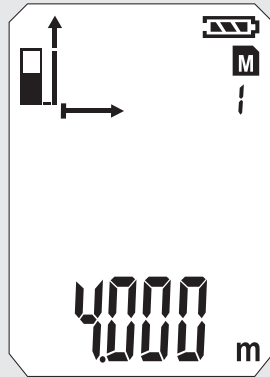
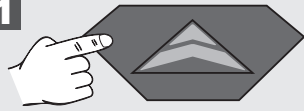

2

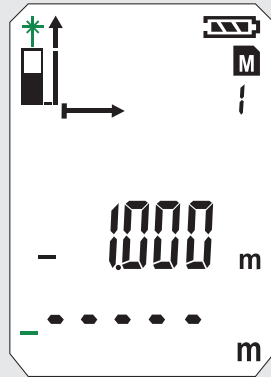
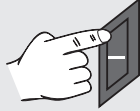

3

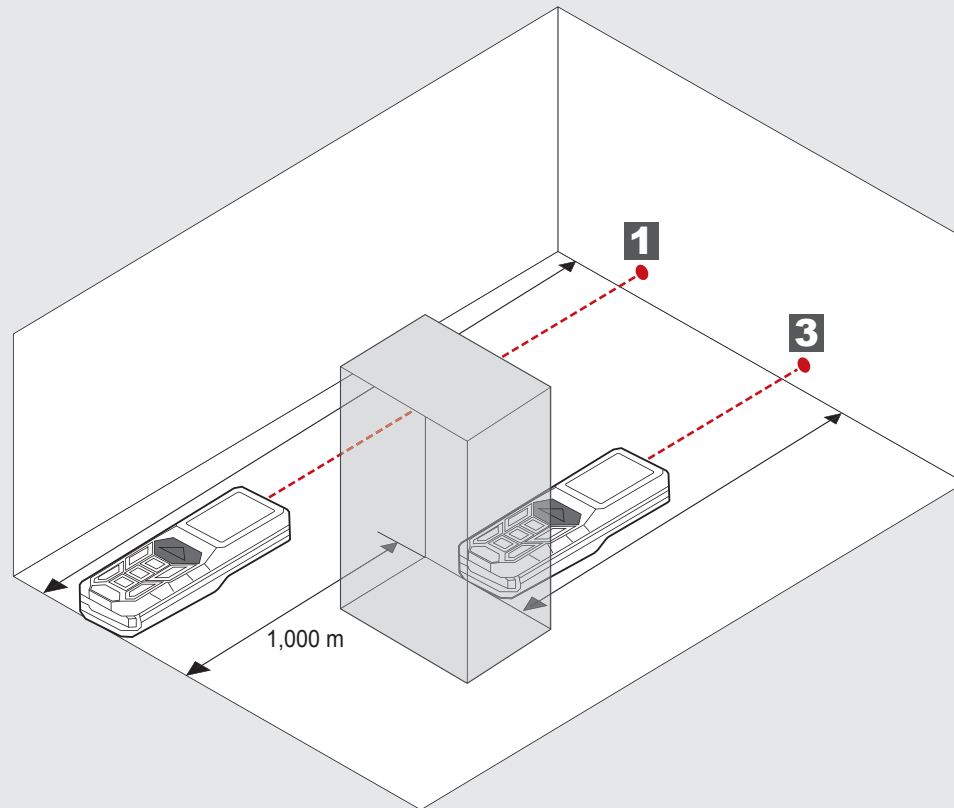
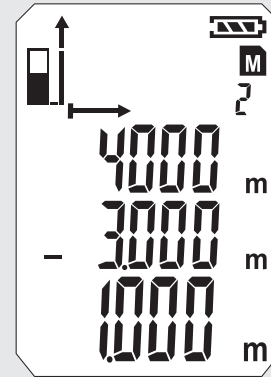
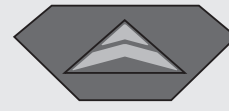

0



1

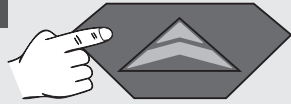

2

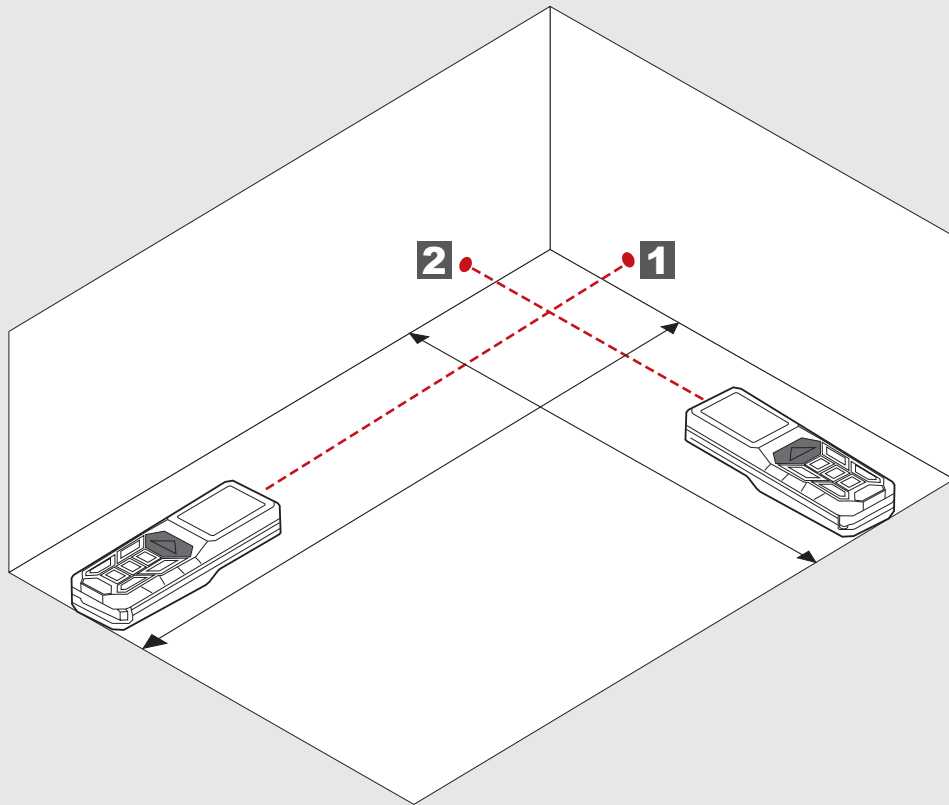
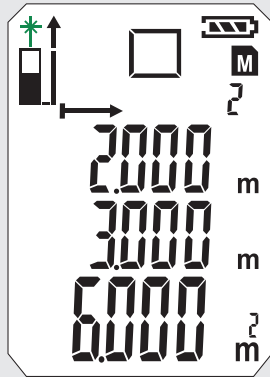
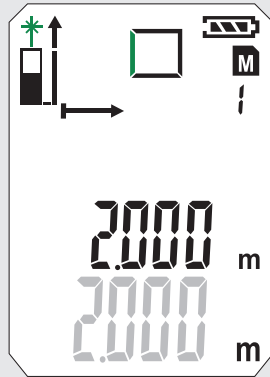
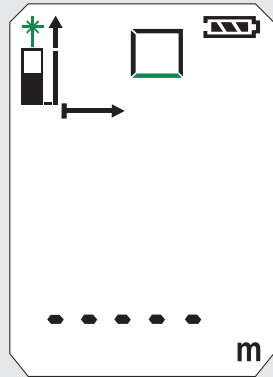
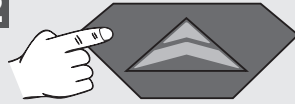

0



2 x

1

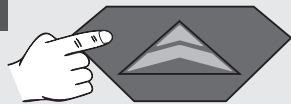

2

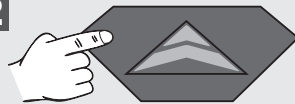

3

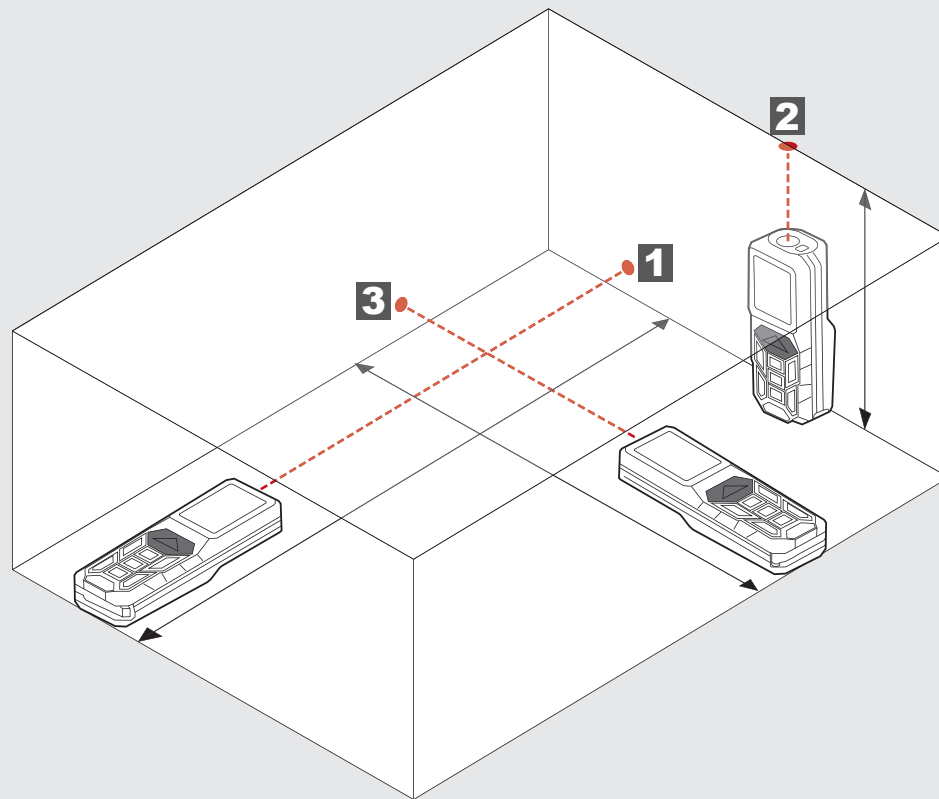
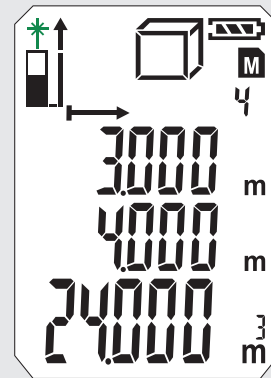
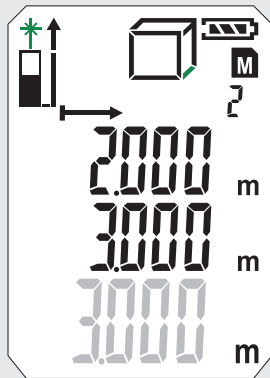
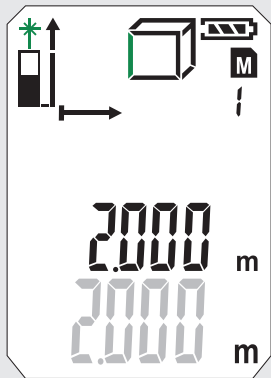
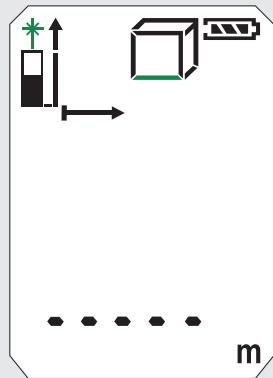
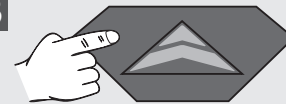

0



1

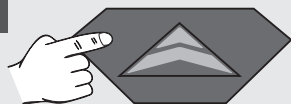

2

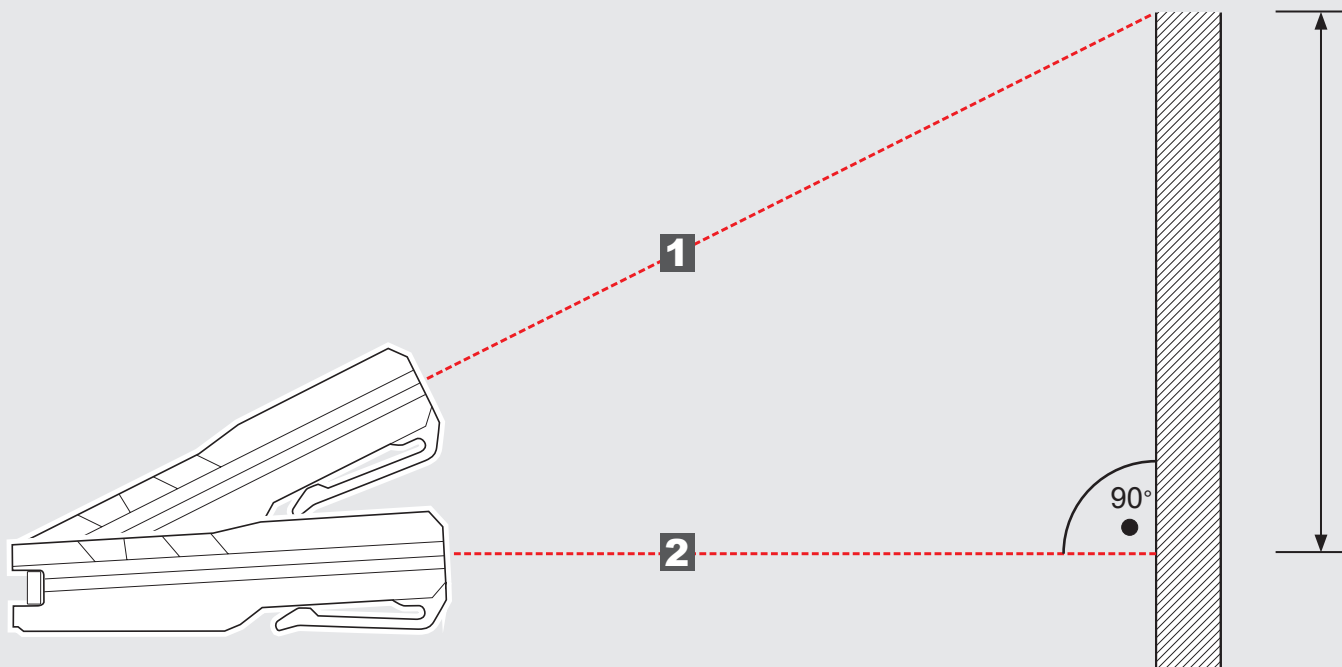
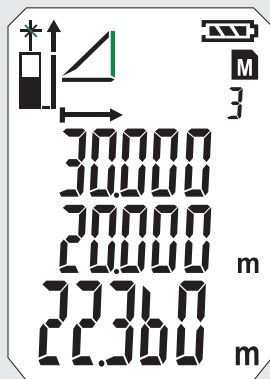
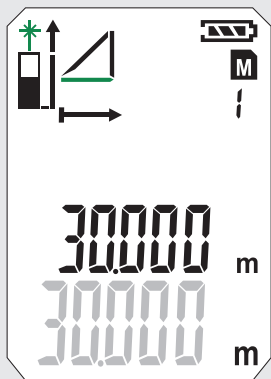
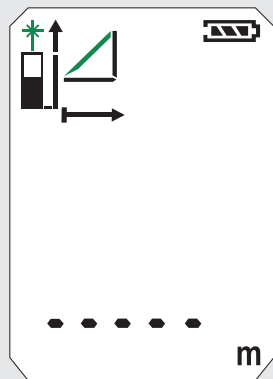
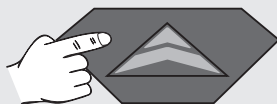

0



1

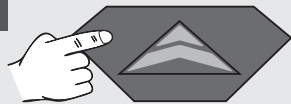

2

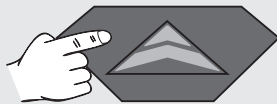

3

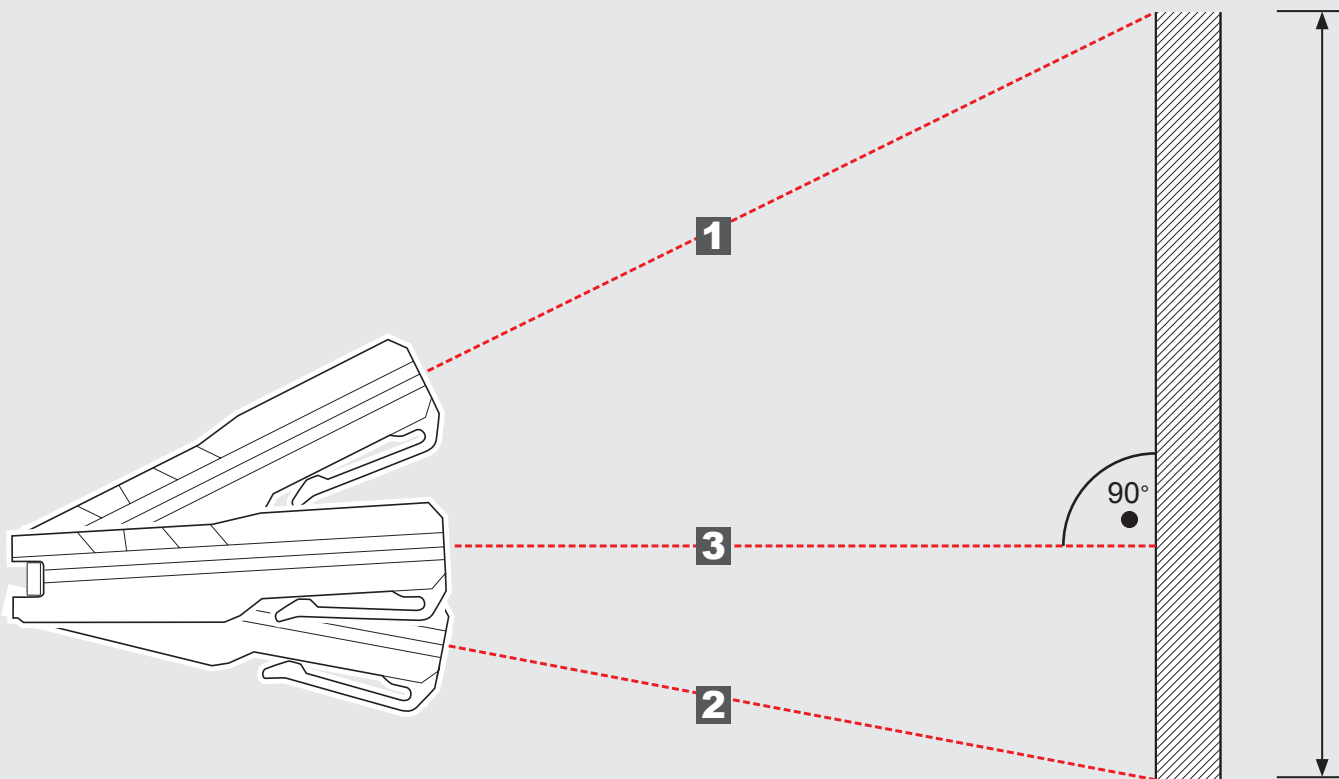
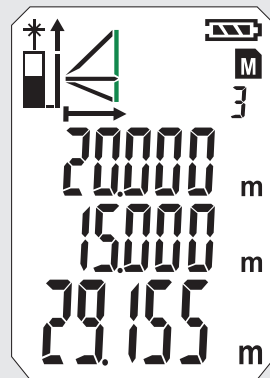
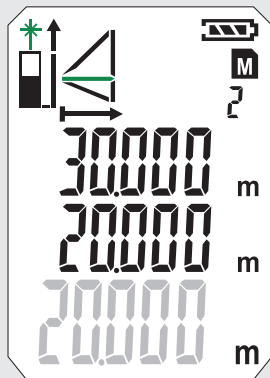
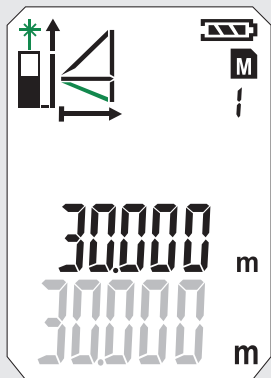
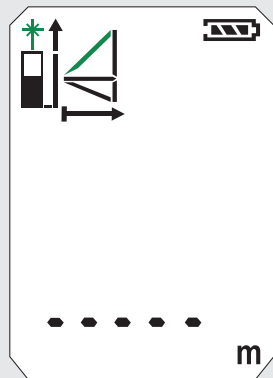
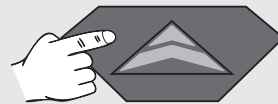

1



2

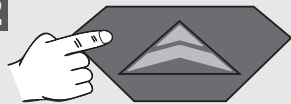

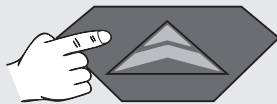

3

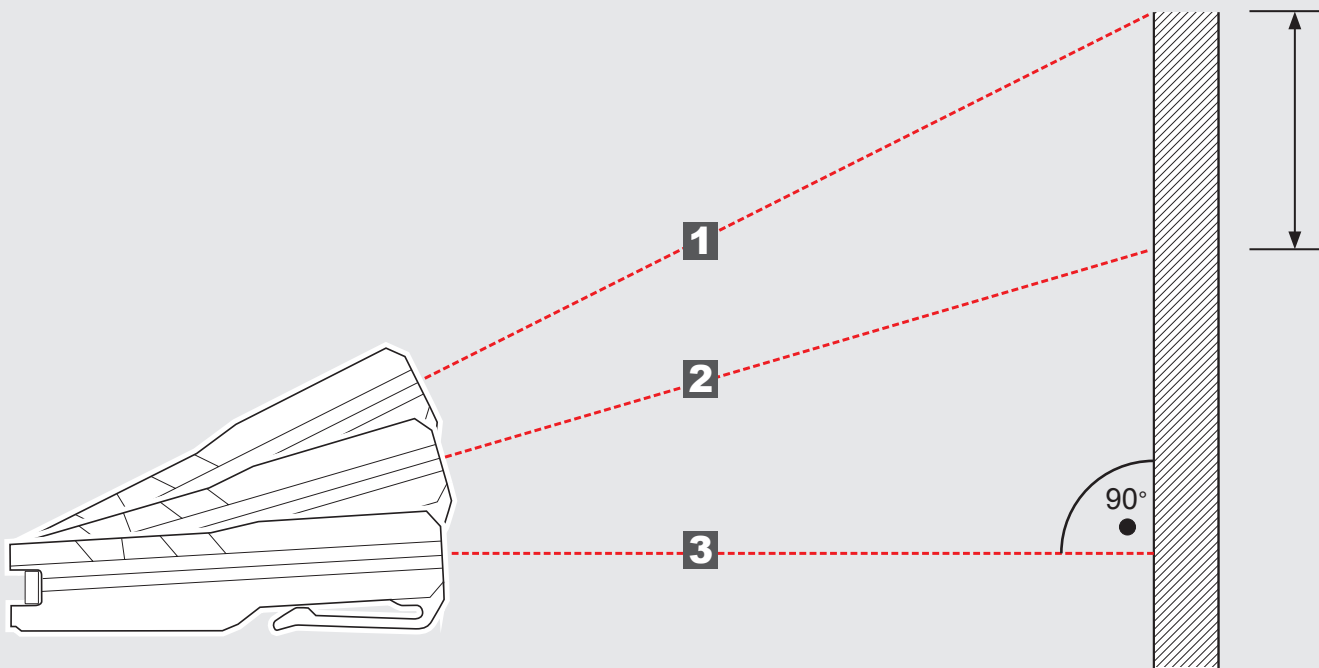
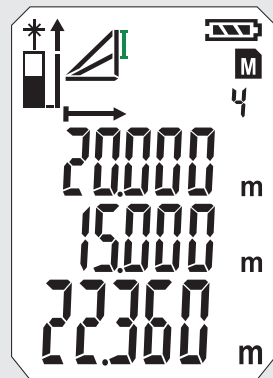
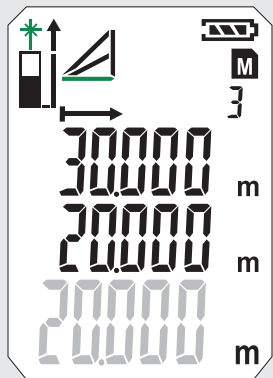
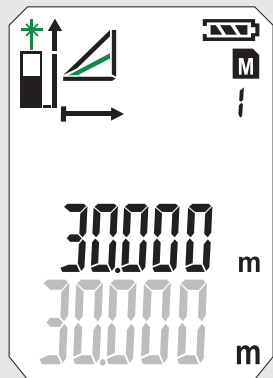
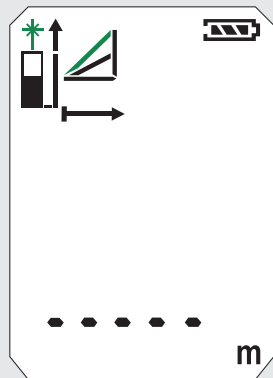
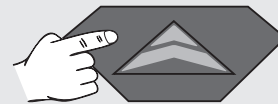

4



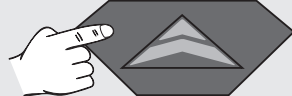
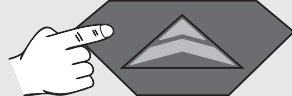
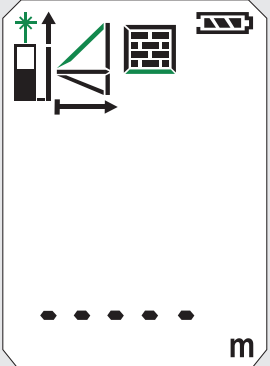
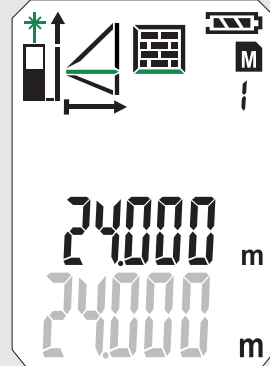
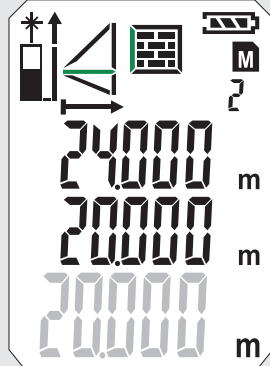
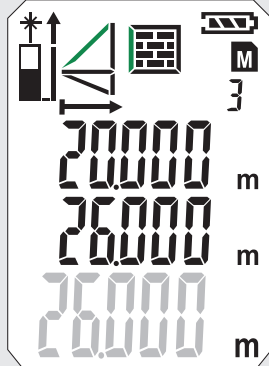
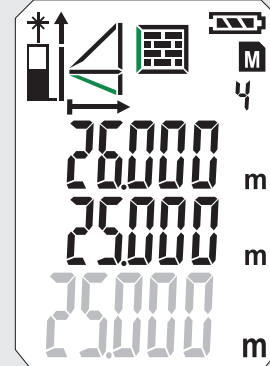

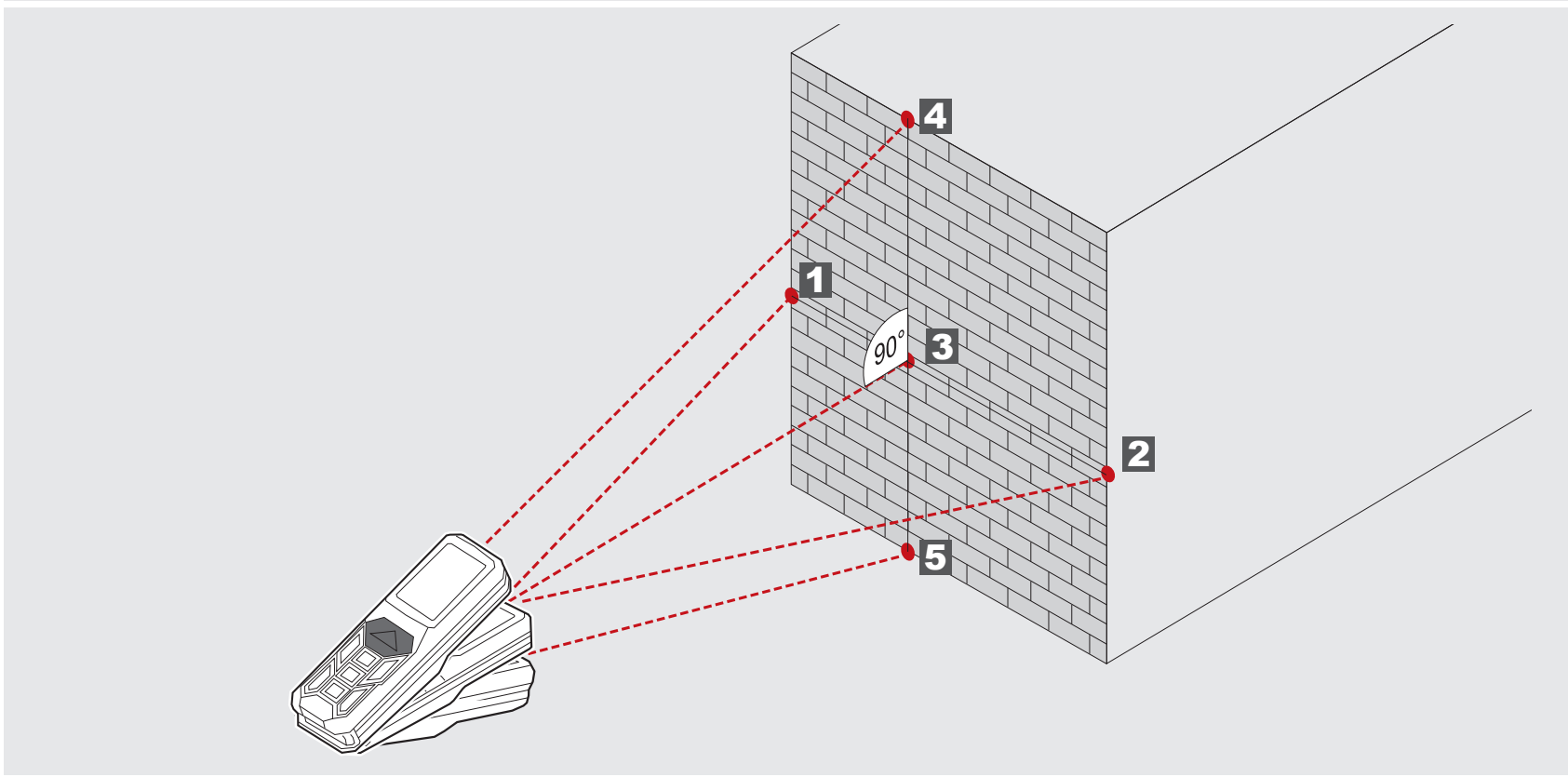





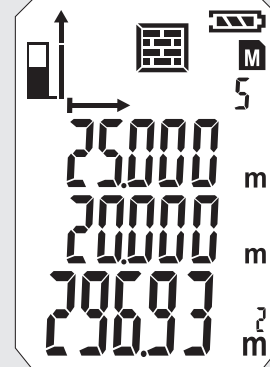

<p>0</p> 	<p>1</p> 	<p>2</p> 	<p>3</p> 	<p>4</p> 
				



5





<p>0</p> 	<p>1</p> 	<p>2</p> 	<p>3</p> 	<p>4</p> 
 <p>..... m</p>	 <p>24000 m</p> <p>24000 m</p>	 <p>24000 m</p> <p>20000 m</p> <p>20000 m</p>	 <p>20000 m</p> <p>26000 m</p> <p>26000 m</p>	 <p>26000 m</p> <p>25000 m</p> <p>25000 m</p>

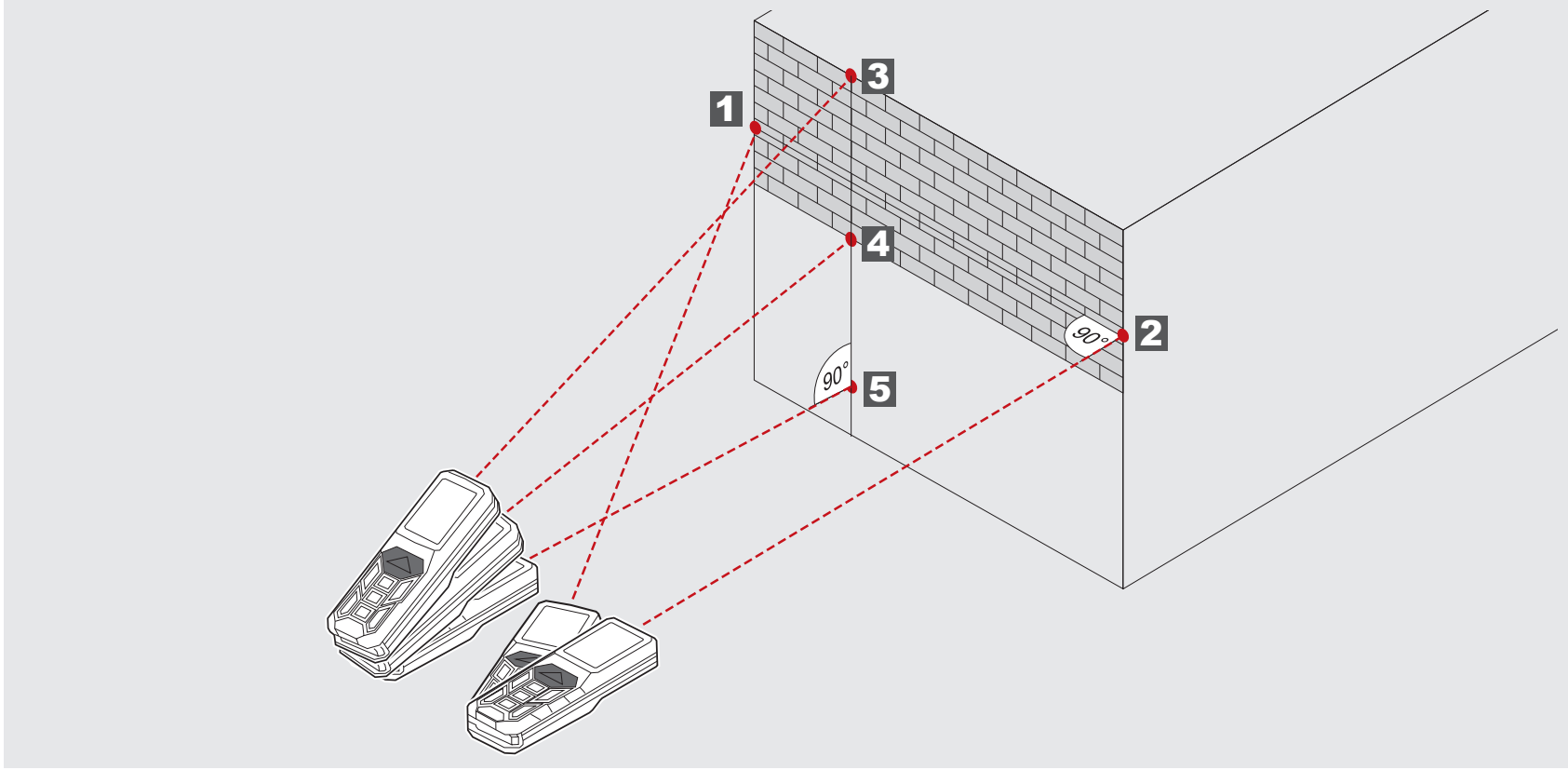

5

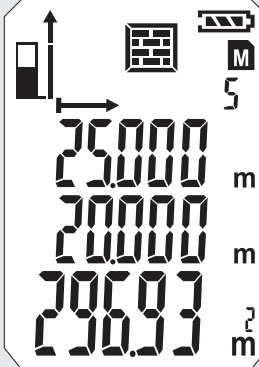
25000 m

20000 m

20000 m

29693 m²

倒计时器

为放置部件等在测量光束中，可以通过倒计时器延迟触发测量程序。

按  键

标志将被显示按  键以调整倒计时器到3至15秒。

按  键

- 倒计时数一直到测量将被触发。
- 到0同时，测量将被触发。

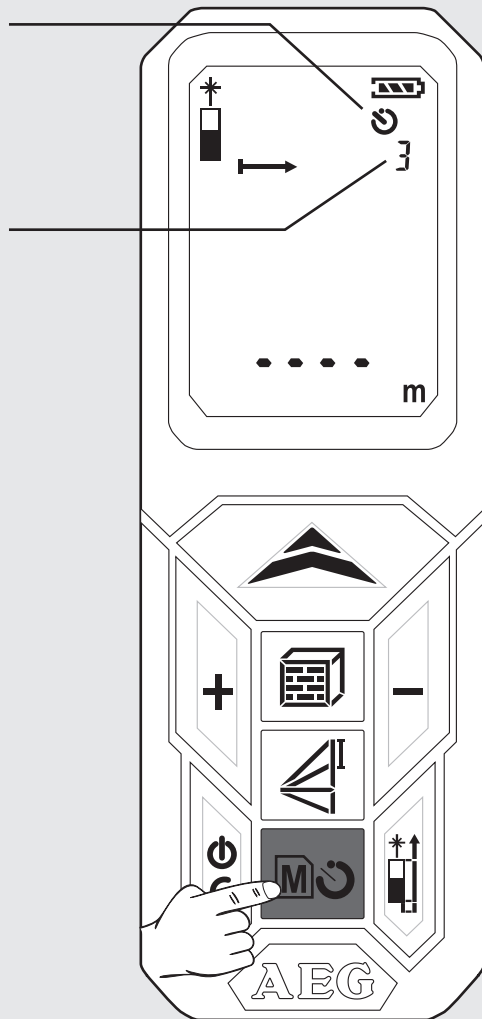

内存

测量数值将自动连续地储存到内存。

通过  键可以读出所储存的数值。

按  键2秒

- 标志和内存位号将被显示。
- 相应测量参数将被显示。
- 被储存数值将被显示在主行内。
- 按 +/- 键以导航。

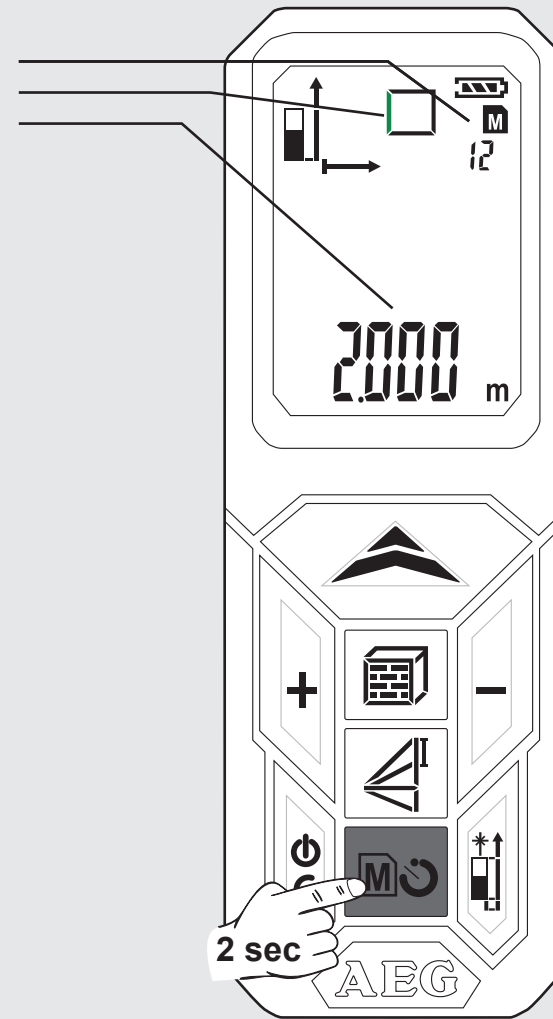

按面积测量的例子说明基本工作原理 (1)

1 接通

按  键。
小心！激光辐射！
严禁对准人员！

2 选择测量平面

接通后标准设置：后面
按1次->边角定位
按2次->前面
按3次->后面

3 选择功能

接通后仪器标准设置为长度测量。
按1次-面积测量

4 长度测量

把仪器对准并
按  键

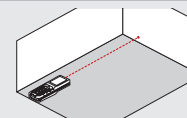

5 宽度测量

把仪器对准并
按  键

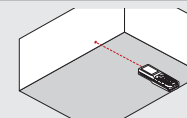

激光标志开始闪亮
(绿色闪亮显示)

标志将被显示

- 标志将被显示
- 参数将被显示 (绿色闪亮显示)

- 测量值将暂时被显示在主行内。
- 1秒后测量值跳到上面一行。
- 测量值将按编号被存储到内存。
- 第二测量参数开始闪亮。
- 仪器待第二数值的测量。

- 测量值将暂时被显示在主行内。
- 1秒后测量值跳到上面一行。
- 测量值将按编号被存储到内存。
- 结果将被显示在主行内并按编号存储到内存。

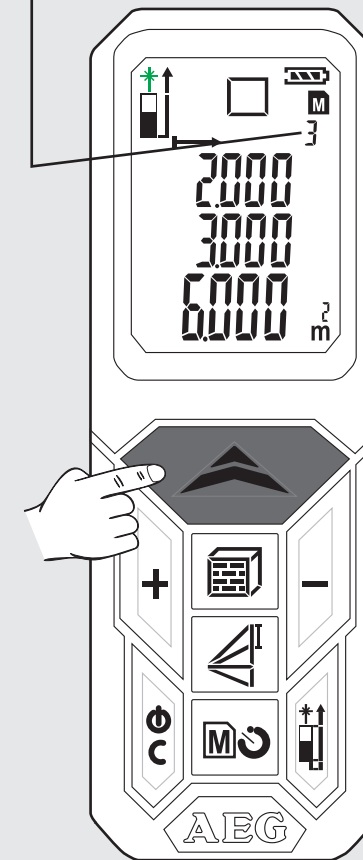
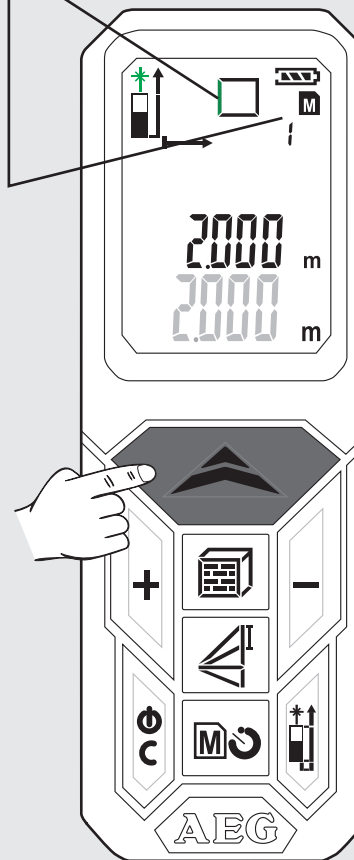
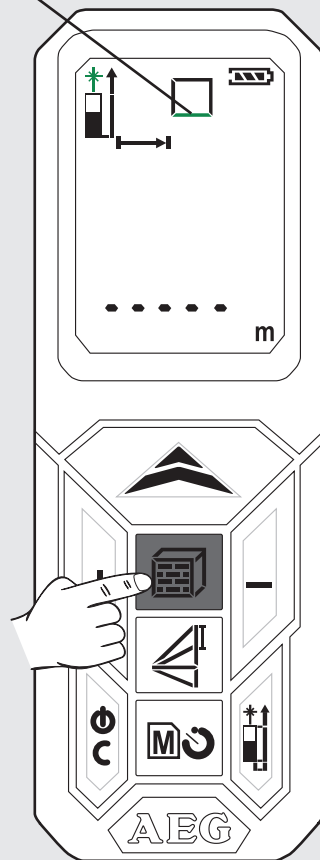
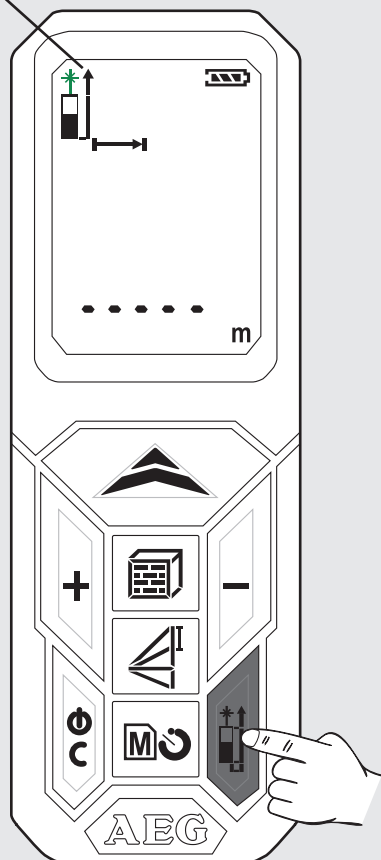
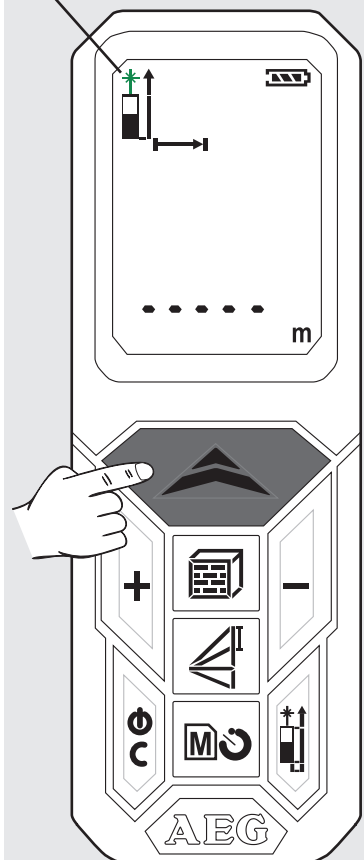

按面积测量的例子说明基本工作原理 (2)

6 读出被存储数值

按  键2秒。
按+或-键。

7 退出内存

按  键

8 关闭

按  键2秒 (退出内存后)

- 被存储的数值将被显示在主行内。
- 相应的标志将被显示，参数开始闪亮 (绿色闪亮显示)。

- 仪器将关闭。
- 如果3分钟不按任何键，仪器将自动关闭。

