

**GARMIN®**

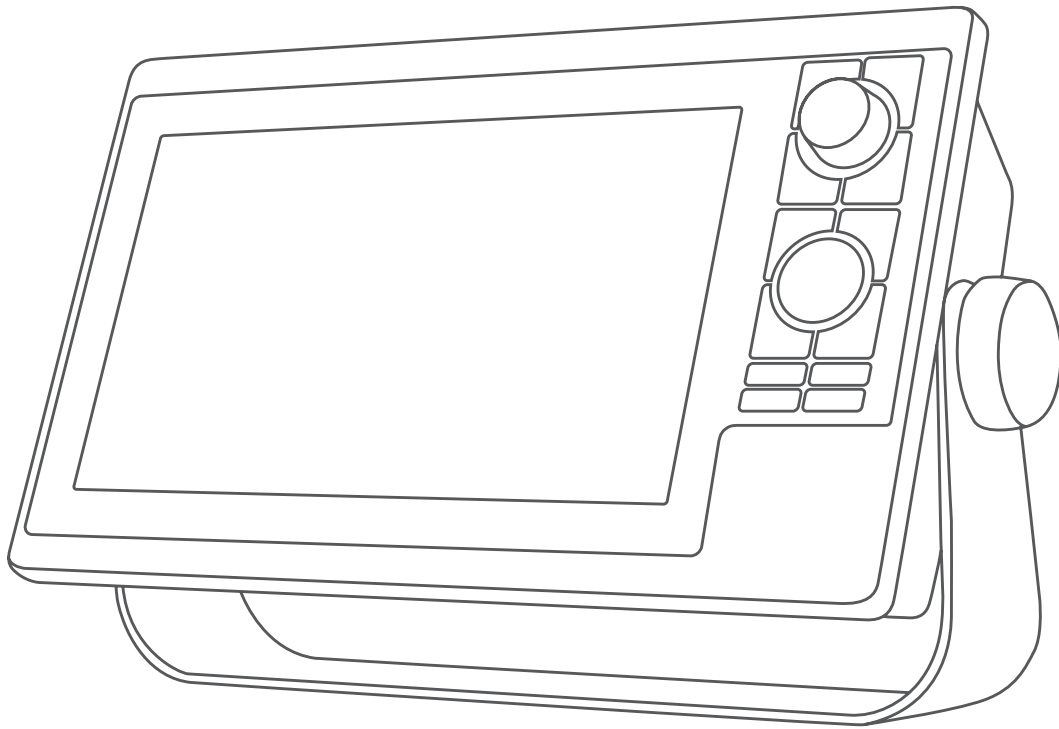

# GPSMAP® 1000/1200 SERIES

---

Owner's Manual

© 2016–2017 Garmin Ltd. or its subsidiaries

All rights reserved. Under the copyright laws, this manual may not be copied, in whole or in part, without the written consent of Garmin. Garmin reserves the right to change or improve its products and to make changes in the content of this manual without obligation to notify any person or organization of such changes or improvements. Go to [www.garmin.com](http://www.garmin.com) for current updates and supplemental information concerning the use of this product.

Garmin®, the Garmin logo, BlueChart®, g2 Vision®, GPSPMAP®, FUSION®, quatix®, Ultrascroll®, and VIRB® are trademarks of Garmin Ltd. or its subsidiaries, registered in the USA and other countries. ActiveCaptain™, ECHOMAP™, Fantom™, FUSION-Link™, Garmin ClearVü™, Garmin Connect™, Garmin Express™, Garmin Helm™, Garmin LakeVü™, Garmin Nautix™, Garmin Quickdraw™, GCV™, GMR™, GRID™, GXM™, HomePort™, MotionScope™, OneChart™, Panoptix™, Shadow Drive™, and SmartMode™ are trademarks of Garmin Ltd. or its subsidiaries. These trademarks may not be used without the express permission of Garmin.

Apple® is a trademark of Apple Inc., registered in the U.S. and other countries. Android™ is a trademark of Google™ Inc. The Bluetooth® word mark and logos are owned by the Bluetooth SIG, Inc. and any use of such marks by Garmin is under license. CZone™ is a trademark of Power Products, LLC. FLIR® is a registered trademark of FLIR Systems, Inc. The SDHC logo is a trademark of SD-3C, LLC. SiriusXM® is a registered trademark of SiriusXM Radio Inc. Wi-Fi® is a registered mark of Wi-Fi Alliance Corporation. Windows® is a registered trademark of Microsoft Corporation in the United States and other countries. All other trademarks and copyrights are the property of their respective owners.

# Table of Contents

<b>Introduction</b> .....	<b>1</b>	Premium Charts.....	7
Device Overview.....	1	Viewing Tide Station Information.....	8
Keys.....	1	Animated Tide and Current Indicators.....	8
Tips and Shortcuts.....	1	Showing Tides and Current Indicators.....	8
Accessing Owner's Manuals on the Chartplotter.....	1	Showing Satellite Imagery on the Navigation Chart.....	8
Downloading the Manuals.....	1	Viewing Aerial Photos of Landmarks.....	8
Garmin Support Center.....	1	Automatic Identification System.....	8
Inserting Memory Cards.....	1	AIS Targeting Symbols.....	8
Acquiring GPS Satellite Signals.....	2	Heading and Projected Course of Activated AIS Targets.....	9
Selecting the GPS Source.....	2	Activating a Target for an AIS Vessel.....	9
<b>Customizing the Chartplotter</b> .....	<b>2</b>	Viewing Information about a Targeted AIS Vessel.....	9
Home Screen.....	2	Deactivating a Target for an AIS Vessel.....	9
Adding an Item to the Favorites Screen.....	2	Viewing a List of AIS and MARPA Threats.....	9
Customizing the Favorites Screen.....	2	Setting the Safe-Zone Collision Alarm.....	9
Customizing Pages.....	2	AIS Distress Signals.....	9
Customizing the Layout of a SmartMode or Combination Page.....	2	Navigating to a Distress Signal Transmission.....	9
Adding a SmartMode Layout.....	2	AIS Distress Signal Device Targeting Symbols.....	9
Creating a New Combination Page.....	3	Enabling AIS Transmission Test Alerts.....	9
Deleting a Combination Page.....	3	Turning Off AIS Reception.....	10
Customizing the Data Overlays.....	3	Chart Menu.....	10
Resetting the Station Layouts.....	3	Chart Layers.....	10
Assigning a Shortcut Key.....	3	Chart Layer Settings.....	10
Presets.....	3	Depth Layer Settings.....	10
Saving a New Preset.....	3	My Vessel Layer Settings.....	10
Managing Presets.....	3	Laylines Settings.....	10
Setting the Vessel Type.....	3	User Data Layer Settings.....	10
Adjusting the Backlight.....	3	Other Vessels Layer Settings.....	11
Adjusting the Color Mode.....	3	Water Layer Settings.....	11
Customizing the Startup Screen.....	4	Weather Layer Settings.....	11
Turning On the Chartplotter Automatically.....	4	Radar Overlay Settings.....	11
Automatically Turning Off the System.....	4	Chart Settings.....	11
<b>ActiveCaptain App</b> .....	<b>4</b>	Fish Eye 3D Settings.....	11
ActiveCaptain Roles.....	4	Supported Maps.....	11
Getting Started with the ActiveCaptain App.....	4	<b>Garmin Quickdraw Contours Mapping</b> .....	<b>11</b>
Receiving Smart Notifications.....	4	Mapping a Body of Water Using the Garmin Quickdraw	
Updating Software with the ActiveCaptain App.....	5	Contours Feature.....	12
Updating Charts with ActiveCaptain.....	5	Adding a Label to a Garmin Quickdraw Contours Map.....	12
<b>Communication with Wireless Devices</b> .....	<b>5</b>	Garmin Quickdraw Community.....	12
Wi-Fi Network.....	5	Connecting to the Garmin Quickdraw Community with	
Setting Up the Wi-Fi Wireless Network.....	5	ActiveCaptain.....	12
Connecting a Wireless Device to the Chartplotter.....	5	Downloading Garmin Quickdraw Community Maps Using	
Changing the Wireless Channel.....	5	ActiveCaptain.....	12
Changing the Wi-Fi Host.....	5	Sharing Your Garmin Quickdraw Contours Maps with the	
Wireless Remote Control.....	5	Garmin Quickdraw Community Using ActiveCaptain.....	12
Pairing the Wireless Remote Control With the		Connecting to the Garmin Quickdraw Community with	
Chartplotter.....	5	Garmin Connect.....	12
Turning On and Off the Remote Backlight.....	5	Sharing Your Garmin Quickdraw Contours Maps with the	
Disconnecting the Remote from All Chartplotters.....	5	Garmin Quickdraw Community Using Garmin Connect.....	12
Wireless Wind Sensor.....	6	Downloading Garmin Quickdraw Community Maps Using	
Connecting a Wireless Sensor to the Chartplotter.....	6	Garmin Connect.....	13
Adjusting the Wind Sensor Orientation.....	6	Garmin Quickdraw Contours Settings.....	13
Connecting a quatix® Watch to the Chartplotter.....	6	Depth Range Shading.....	13
Connecting a Garmin Nautix™ Device to the Chartplotter.....	6	<b>Navigation with a Chartplotter</b> .....	<b>13</b>
<b>Charts and 3D Chart Views</b> .....	<b>6</b>	Basic Navigation Questions.....	14
Navigation Chart and Fishing Chart.....	6	Destinations.....	14
Chart Symbols.....	7	Searching for a Destination by Name.....	14
Selecting an Item on the Map Using the Device Keys.....	7	Selecting a Destination Using the Navigation Chart.....	14
Measuring a Distance on the Chart.....	7	Searching for a Marine Services Destination.....	14
Creating a Waypoint on the Chart.....	7	Stopping Navigation.....	14
Viewing Location and Object Information on a Chart.....	7	Waypoints.....	14
Viewing Details about Nav aids.....	7	Marking Your Present Location as a Waypoint.....	14
Navigating to a Point on the Chart.....	7	Creating a Waypoint at a Different Location.....	14
		Marking an SOS Location.....	14
		Viewing a List of all Waypoints.....	14
		Editing a Saved Waypoint.....	14
		Moving a Saved Waypoint.....	14

Browsing for and Navigating to a Saved Waypoint .....	14	Tacking and Gybing from Heading Hold .....	20
Deleting a Waypoint or an MOB .....	15	Tacking and Gybing from Wind Hold .....	20
Deleting All Waypoints .....	15	Setting a Tack and Gybe Delay .....	20
Setting and Following a Direct Course Using Go To .....	15	Enabling the Gybe Inhibitor .....	21
Routes .....	15	Heading Line and Angle Markers .....	21
Creating and Navigating a Route From Your Present Location .....	15	Setting the Heading Line and Angle Markers .....	21
Creating and Saving a Route .....	15	<b>Sonar Fishfinder .....</b>	<b>21</b>
Viewing a List of Routes and Auto Guidance Paths .....	15	Stopping the Transmission of Sonar Signals .....	21
Editing a Saved Route .....	15	Changing the Sonar View .....	21
Browsing for and Navigating a Saved Route .....	15	Traditional Sonar View .....	21
Browsing for and Navigating Parallel to a Saved Route .....	16	Split-Frequency Sonar View .....	21
Deleting a Saved Route .....	16	Split-Zoom Sonar View .....	21
Deleting All Saved Routes .....	16	Garmin ClearVü Sonar View .....	21
Auto Guidance .....	16	SideVü Sonar View .....	22
Setting and Following an Auto Guidance Path .....	16	SideVü Scanning Technology .....	22
Creating and Saving an Auto Guidance Path .....	16	Measuring Distance on the Sonar Screen .....	22
Adjusting a Saved Auto Guidance Path .....	16	Panoptix Sonar Views .....	22
Canceling an Auto Guidance Calculation in Progress .....	16	LiveVü Down Sonar View .....	22
Setting a Timed Arrival .....	16	LiveVü Forward Sonar View .....	22
Auto Guidance Path Configurations .....	16	RealVü 3D Forward Sonar View .....	23
Adjusting the Distance from Shore .....	17	RealVü 3D Down Sonar View .....	23
Tracks .....	17	RealVü 3D Historical Sonar View .....	23
Showing Tracks .....	17	FrontVü Sonar View .....	23
Setting the Color of the Active Track .....	17	Selecting the Transducer Type .....	23
Saving the Active Track .....	17	Calibrating the Compass .....	23
Viewing a List of Saved Tracks .....	17	Creating a Waypoint on the Sonar Screen .....	23
Editing a Saved Track .....	17	Pausing the Sonar Display .....	23
Saving a Track as a Route .....	17	Viewing Sonar History .....	23
Browsing for and Navigating a Recorded Track .....	18	Sonar Sharing .....	24
Deleting a Saved Track .....	18	Selecting a Sonar Source .....	24
Deleting All Saved Tracks .....	18	Renaming a Sonar Source .....	24
Retracing the Active Track .....	18	Adjusting the Level of Detail .....	24
Clearing the Active Track .....	18	Adjusting the Range, Gain, and Brightness With the Knob .....	24
Managing the Track Log Memory During Recording .....	18	Adjusting the Color Intensity .....	24
Configuring the Recording Interval of the Track Log .....	18	Sonar Recordings .....	24
Boundaries .....	18	Recording the Sonar Display .....	24
Creating a Boundary .....	18	Stopping the Sonar Recording .....	24
Converting a Route to a Boundary .....	18	Deleting a Sonar Recording .....	24
Converting a Track to a Boundary .....	18	Playing Sonar Recordings .....	24
Editing a Boundary .....	18	Traditional, Garmin ClearVü, and SideVü Sonar Setup .....	25
Linking a Boundary to a SmartMode Layout .....	18	Setting the Zoom Level on the Sonar Screen .....	25
Setting a Boundary Alarm .....	18	Setting the Scroll Speed .....	25
Deleting a Boundary .....	19	Adjusting the Range of the Depth or Width Scale .....	25
Synchronizing User Data Across the Garmin Marine Network .....	19	Sonar Noise Rejection Settings .....	25
Deleting All Saved Waypoints, Routes, and Tracks .....	19	Sonar Appearance Settings .....	25
<b>Sailing Features .....</b>	<b>19</b>	Sonar Alarms .....	26
Setting the Vessel Type .....	19	Advanced Sonar Settings .....	26
Sail Racing .....	19	Traditional, Garmin ClearVü, and SideVü Transducer Installation Settings .....	26
Starting Line Guidance .....	19	Sonar Frequencies .....	26
Setting the Starting Line .....	19	Selecting Frequencies .....	27
Using the Starting Line Guidance .....	19	Creating a Frequency Preset .....	27
Starting the Race Timer .....	19	Turning On the A-Scope .....	27
Stopping the Race Timer .....	19	Panoptix Sonar Setup .....	27
Setting the Distance between the Bow and the GPS Antenna .....	19	Adjusting the RealVü Viewing Angle and Zoom Level .....	27
Laylines Settings .....	19	Adjusting the RealVü Sweep Speed .....	27
Setting the Keel Offset .....	20	LiveVü Forward and FrontVü Sonar Menu .....	27
Sailboat Autopilot Operation .....	20	Setting the LiveVü and FrontVü Transducer Transmit Angle .....	27
Wind Hold .....	20	Setting the FrontVü Depth Alarm .....	28
Setting the Wind Hold Type .....	20	LiveVü and FrontVü Appearance Settings .....	28
Engaging Wind Hold .....	20	RealVü Appearance Settings .....	28
Engaging Wind Hold from Heading Hold .....	20	Panoptix Transducer Installation Settings .....	28
Adjusting the Wind Hold Angle with the Autopilot .....	20	Setting the Bow Offset .....	28
Tack and Gybe .....	20	<b>Radar .....</b>	<b>29</b>
		Radar Interpretation .....	29

Radar Overlay.....	29	Setting Up and Following a Search Pattern.....	35
Radar Overlay and Chart Data Alignment.....	29	Cancelling a Steering Pattern.....	35
Transmitting Radar Signals.....	29	<b>Digital Selective Calling.....</b>	<b>35</b>
Stopping the Transmission of Radar Signals.....	29	Networked Chartplotter and VHF Radio Functionality.....	35
Setting Up the Timed Transmit Mode.....	29	Turning On DSC.....	35
Enabling and Adjusting a Radar No Transmit Zone.....	29	DSC List.....	35
Adjusting the Radar Range.....	30	Viewing the DSC List.....	35
Tips for Selecting a Radar Range.....	30	Adding a DSC Contact.....	35
MotionScope™ Doppler Radar Technology.....	30	Incoming Distress Calls.....	35
Enabling a Guard Zone.....	30	Navigating to a Vessel in Distress.....	35
Defining a Circular Guard Zone.....	30	Man-Overboard Distress Calls Initiated from a VHF	
Defining a Partial Guard Zone.....	30	Radio.....	36
Disabling a Guard Zone.....	30	Man-Overboard and SOS Distress Calls Initiated from the	
MARPA.....	30	Chartplotter.....	36
MARPA Targeting Symbols.....	30	Position Tracking.....	36
Assigning a MARPA Tag to an Object.....	31	Viewing a Position Report.....	36
Removing a MARPA Tag from a Targeted Object.....	31	Navigating to a Tracked Vessel.....	36
Viewing Information about a MARPA-tagged Object.....	31	Creating a Waypoint at the Position of a Tracked Vessel....	36
Viewing a List of AIS and MARPA Threats.....	31	Editing Information in a Position Report.....	36
Showing AIS Vessels on the Radar Screen.....	31	Deleting a Position-Report Call.....	36
VRM and EBL.....	31	Viewing Vessel Trails on the Chart.....	36
Showing the VRM and the EBL.....	31	Individual Routine Calls.....	36
Adjusting the VRM and the EBL.....	31	Selecting a DSC Channel.....	36
Measuring the Range and Bearing to a Target Object....	31	Making an Individual Routine Call.....	36
Echo Trails.....	31	Making an Individual Routine Call to an AIS Target.....	36
Turning on Echo Trails.....	31	<b>Gauges and Graphs.....</b>	<b>36</b>
Adjusting the Length of the Echo Trails.....	31	Viewing the Gauges.....	37
Clearing the Echo Trails.....	31	Changing the Data Shown in a Gauge.....	37
Optimizing the Radar Display.....	31	Customizing the Gauges.....	37
Radar Gain and Clutter.....	31	Customizing Engine Gauge and Fuel Gauge Limits.....	37
Adjusting Gain on the Radar Screen Automatically.....	31	Viewing Engine and Fuel Gauges.....	37
Adjusting Gain on the Radar Screen Manually.....	32	Selecting the Number of Engines Shown in Gauges.....	37
Minimizing Nearby Large-Object Interference.....	32	Customizing the Engines Shown in Gauges.....	37
Minimizing Side-Lobe Interference on the Radar		Enabling Status Alarms for Engine Gauges.....	37
Screen.....	32	Enabling Some Engine Gauge Status Alarms.....	37
Adjusting Sea Clutter on the Radar Screen		Setting the Fuel Alarm.....	37
Automatically.....	32	Setting the Fuel Capacity of the Vessel.....	37
Adjusting Sea Clutter on the Radar Screen Manually....	32	Synchronizing the Fuel Data with the Actual Vessel Fuel...	37
Adjusting Rain Clutter on the Radar Screen.....	32	Viewing the Wind Gauges.....	37
Reducing Cross Talk Clutter on the Radar Screen.....	32	Configuring the Sailing Wind Gauge.....	37
Radar Options Menu.....	32	Configuring the Speed Source.....	38
Radar Setup Menu.....	33	Configuring the Heading Source of the Wind Gauge.....	38
Radar Appearance Settings.....	33	Customizing the Close-Hauled Wind Gauge.....	38
Radar Installation Settings.....	33	Viewing Trip Gauges.....	38
Front-of-Boat Offset.....	33	Resetting Trip Gauges.....	38
Setting a Custom Park Position.....	33	Viewing Graphs.....	38
Selecting a Different Radar Source.....	33	Setting the Graph Range and Time Scales.....	38
Changing the Radar Mode.....	33	Battery Management.....	38
<b>Autopilot.....</b>	<b>33</b>	Setting Up the Battery Management Page.....	38
Opening the Autopilot Screen.....	34	<b>Tide, Current, and Celestial Information.....</b>	<b>38</b>
Autopilot Screen.....	34	Tide Station Information.....	38
Adjusting the Step Steering Increment.....	34	Current Station Information.....	38
Setting the Power Saver.....	34	Celestial Information.....	38
Enabling Shadow Drive™.....	34	Viewing Tide Station, Current Station, or Celestial Information	
Autopilot Overlay Bar.....	34	for a Different Date.....	39
Engaging the Autopilot.....	34	Viewing Information for a Different Tide or Current Station....	39
Adjusting the Heading with the Helm.....	34	Viewing Almanac Information from the Navigation Chart.....	39
Adjusting the Heading with the Chartplotter in Step Steering		<b>Warning Manager.....</b>	<b>39</b>
Mode.....	34	Viewing Messages.....	39
Steering Patterns.....	34	Sorting and Filtering Messages.....	39
Following the U-Turn Pattern.....	34	Saving Messages to a Memory Card.....	39
Setting Up and Following the Circles Pattern.....	34	Clearing all of the Messages.....	39
Setting Up and Following the Zigzag Pattern.....	35	<b>Media Player.....</b>	<b>39</b>
Following the Williamson Turn Pattern.....	35	Opening the Media Player.....	39
Following an Orbit Pattern.....	35		
Setting Up and Following the Cloverleaf Pattern.....	35		

Icons .....	39	Forecasting Fish Locations .....	43
Selecting the Media Source .....	39	Changing the Sea Surface Temperature Color Range .....	43
Playing Music .....	39	Visibility Information .....	43
Browsing for Music .....	39	Viewing Forecast Visibility Information for Another Time	
Enabling Alphabetical Search .....	39	Period .....	44
Setting a Song to Repeat .....	39	Viewing Buoy Reports .....	44
Setting All Songs to Repeat .....	39	Viewing Local Weather Information near a Buoy .....	44
Setting Songs to Shuffle .....	39	Weather Overlay .....	44
Adjusting the Volume .....	39	Turning On the Weather Overlay on a Chart .....	44
Muting the Media Volume .....	39	Weather Overlay Settings on the Navigation Chart .....	44
Enabling and Disabling Zones .....	39	Weather Overlay Settings on the Fishing Chart .....	44
VHF Radio .....	40	Viewing Weather Subscription Information .....	44
Scanning VHF Channels .....	40	<b>Viewing Video .....</b>	<b>44</b>
Adjusting the VHF Squelch .....	40	Selecting a Video Source .....	44
Radio .....	40	Alternating Among Multiple Video Sources .....	44
Setting the Tuner Region .....	40	Networked Video Devices .....	44
Changing the Radio Station .....	40	Using Video Presets on Networked Video Cameras .....	44
Changing the Tuning Mode .....	40	Saving Video Presets on a Networked Video Camera ...	44
Presets .....	40	Naming Video Presets on a Networked Video Camera ..	45
Saving a Station as a Preset .....	40	Activating Video Presets on a Networked Video	
Selecting a Preset .....	40	Camera .....	45
Removing a Preset .....	40	Camera Settings .....	45
DAB Playback .....	40	Video Settings .....	45
Setting the DAB Tuner Region .....	40	Associating the Camera to a Video Source .....	45
Scanning for DAB Stations .....	40	Video Camera Movement Control .....	45
Changing DAB Stations .....	40	Controlling Video Cameras Using On-Screen Controls ..	45
Selecting a DAB Station from a List .....	40	Configuring the Video Appearance .....	45
Selecting a DAB Station from a Category .....	40	Garmin VIRB® Action Cameras .....	45
DAB Presets .....	40	Connecting a VIRB 360 Action Camera .....	45
Saving a DAB Station as a Preset .....	40	Connecting a VIRB Action Camera .....	46
Selecting a DAB Preset from a List .....	40	Controlling the VIRB Action Camera with the	
Removing DAB Presets .....	40	Chartplotter .....	46
SiriusXM Satellite Radio .....	41	VIRB Action Camera Settings .....	46
Locating a SiriusXM Radio ID .....	41	VIRB Action Camera Video Setup Settings .....	46
Activating a SiriusXM Subscription .....	41	Adding the VIRB Action Camera Controls to Other	
Customizing the Channel Guide .....	41	Screens .....	46
Saving a SiriusXM Channel to the Presets List .....	41	Controlling the VIRB Action Camera Video Playback .....	46
Unlocking SiriusXM Parental Controls .....	41	Starting a VIRB Video Slideshow .....	46
Setting Parental Controls on SiriusXM Radio		<b>Device Configuration .....</b>	<b>46</b>
Channels .....	41	System Settings .....	46
Changing a Parental Passcode on a SiriusXM Radio .....	41	Sounds and Display Settings .....	47
Restoring Default Parental Control Settings Values .....	41	GPS Settings .....	47
Clearing All Locked Channels on a SiriusXM Radio .....	41	Station Settings .....	47
Setting the Device Name .....	41	Viewing System Software Information .....	47
Updating the Media Player Software .....	41	Viewing the Event Log .....	47
<b>SiriusXM Weather .....</b>	<b>41</b>	Preferences Settings .....	47
SiriusXM Equipment and Subscription Requirements .....	42	Units Settings .....	47
Weather Data Broadcasts .....	42	Navigation Settings .....	47
Changing the Weather Chart .....	42	Auto Guidance Path Configurations .....	47
Viewing Precipitation Information .....	42	Adjusting the Distance from Shore .....	48
Precipitation Views .....	42	Communications Settings .....	48
Storm Cell and Lightning Information .....	42	NMEA 0183 Settings .....	48
Hurricane Information .....	42	Configuring NMEA 0183 Output Sentences .....	48
Weather Warnings and Weather Bulletins .....	42	Setting the Communication Format for Each NMEA 0183	
Forecast Information .....	42	Port .....	48
Viewing Forecast Information for Another Time Period .....	42	NMEA 2000 Settings .....	49
Weather Fronts and Pressure Centers .....	42	Naming Devices and Sensors on the Network .....	49
Viewing a Marine Forecast or an Offshore Forecast .....	43	Marine Network .....	49
City Forecasts .....	43	Setting Alarms .....	49
Viewing Sea Conditions .....	43	Navigation Alarms .....	49
Surface Winds .....	43	Setting the Anchor Drag Alarm .....	49
Wave Height, Wave Period, and Wave Direction .....	43	System Alarms .....	49
Viewing Forecast Sea Conditions Information for Another		Sonar Alarms .....	49
Time Period .....	43	Setting Weather Alarms .....	49
Viewing Fishing Information .....	43	Setting the Fuel Alarm .....	49
Surface Pressure and Water Temperature Data .....	43	My Vessel Settings .....	49

Setting the Keel Offset.....	49
Setting the Water Temperature Offset.....	50
Calibrating a Water Speed Device.....	50
Other Vessels Settings.....	50
Settings that are Synced on the Garmin Marine Network.....	50
Restoring the Original Chartplotter Factory Settings.....	51
<b>Sharing and Managing User Data.....</b>	<b>51</b>
Copying Waypoints, Routes, and Tracks from HomePort to a Chartplotter.....	51
Selecting a File Type for Third-Party Waypoints and Routes...	51
Copying User Data from a Memory Card.....	51
Copying User Data to a Memory Card.....	51
Copying Built-In Maps to a Memory Card.....	51
Backing Up Data to a Computer.....	51
Restoring Backup Data to a Chartplotter.....	51
Saving System Information to a Memory Card.....	52
<b>Appendix.....</b>	<b>52</b>
Registering Your Device.....	52
Software Update.....	52
Loading the New Software on a Memory Card.....	52
Updating the Device Software.....	52
Digital Switching.....	52
Pairing the GRID Remote Input Device with the Chartplotter...	53
Pairing the GRID Device with the Chartplotter from the Chartplotter.....	53
Pairing the GRID Device with the Chartplotter from the GRID Device.....	53
Rotating the GRID Joystick.....	53
Cleaning the Screen.....	53
Viewing Images on a Memory card.....	53
Screenshots.....	53
Capturing Screenshots.....	53
Copying Screenshots to a Computer.....	53
Troubleshooting.....	53
My device will not acquire GPS signals.....	53
My device will not turn on or keeps turning off.....	53
My device is not creating waypoints in the correct location.....	53
Contacting Garmin Support.....	54
Specifications.....	54
Specifications.....	54
NMEA 2000 PGN Information.....	54
NMEA 0183 Information.....	55
<b>Index.....</b>	<b>56</b>





# Introduction

## ⚠ WARNING

See the *Important Safety and Product Information* guide in the product box for product warnings and other important information.

**NOTE:** Not all features are available on all models.

The Garmin® website at [www.garmin.com](http://www.garmin.com) presents up-to-date information about your product. The support pages will provide answers to frequently asked support questions, and you can download software and chart updates. There is also contact information to Garmin support should you have any questions.

## Device Overview



①	Power key
②	Knob
③	Device keys
④	Arrow keys
⑤	Shortcut keys

## Keys

	Hold to turn on and off the device. Press repeatedly to scroll through the backlight brightness levels.
Knob	Turn to zoom in or out of a view. Turn to highlight an option in a menu. Press to select a highlighted option.
HOME	Press to return to the home screen.
MENU	Press to open or close a menu of options for a page.
FOCUS	Press to move a highlight to a different section of a page. Press to move a highlight to a different function or window on a combination page.
	Press to pan on a chart or sonar screen. Press to move the cursor. Press to highlight an option in a menu.
BACK	Press to return to the previous screen.
SELECT	Press to acknowledge messages and select options.
NAV INFO	Press to display navigation information, such as points of interest, user data, and graphs.
MARK/SOS	Press to save the present location as a waypoint. Hold for one second to mark an SOS location, and begin a route back to the location.
Shortcut keys	Hold to create a shortcut to a selected function. Press to open a shortcut to a selected function.

## Tips and Shortcuts

- Press to turn on the chartplotter.
- Select **HOME** from any screen to return to the Home screen.
- Select **MENU** to open additional settings about that screen.
- Select **MENU** to close the menu when finished.

- Press to open additional options, such as adjusting the backlight and locking the touchscreen.
- Press , and select **Power Off > Turn Off System**, or hold until the **Turn Off System** bar fills to turn off the chartplotter.
- Press , and select **Power Off > Sleep Station** to set the chartplotter to standby mode.
- On the home screen of some models, swipe up or down on the category buttons along the right to view the additional buttons.  
On some models, not all category buttons on the right side of the screen are visible. The arrows at the top or bottom of the buttons indicate not all buttons are visible.
- On some menu buttons, press the button to enable the option.

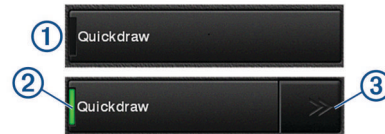

A green light on an option indicates the option is enabled .

- When available, press the arrows to open the menu. On some buttons, when an option is selected , the menu arrows appear.
- Turn the knob to highlight options.
- Turn the knob to zoom in or out of a screen.
- Hold a numbered key to create a shortcut to a screen.

## Accessing Owner's Manuals on the Chartplotter

- 1 Select **NAV INFO > Owner's Manual**.
- 2 Select a manual.
- 3 Select **Open**.

## Downloading the Manuals

You can get the latest owner's manual and translations of manuals from the Garmin website.

- 1 Go to [garmin.com/manuals/gpsmap10x2-12x2](http://garmin.com/manuals/gpsmap10x2-12x2).
- 2 Download the manual.

## Garmin Support Center

Go to [support.garmin.com](http://support.garmin.com) for help and information, such as product manuals, frequently asked questions, videos, software updates, and customer support.

## Inserting Memory Cards

You can use optional memory cards with the chartplotter. Map cards allow you to view high-resolution satellite imagery and aerial reference photos of ports, harbors, marinas, and other points of interest. You can use blank memory cards to record Garmin Quickdraw™ Contours mapping, record sonar (with a compatible transducer), transfer data such as waypoints and routes to another compatible chartplotter or a computer, and use the ActiveCaptain™ app.

This device supports up to a 32 GB memory card, formatted to FAT32.

- 1 Open the access flap or door on the front of the chartplotter.

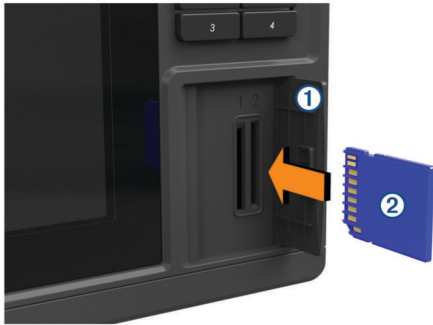

- 2 Insert the memory card ②.
- 3 Press the card in until it clicks.
- 4 Close the door.



## Acquiring GPS Satellite Signals

The device may need a clear view of the sky to acquire satellite signals. The time and date are set automatically based on the GPS position.

- 1 Turn on the device.
- 2 Wait while the device locates satellites.

It may take 30 to 60 seconds to acquire satellite signals.

When the device acquires satellite signals,  appears at the top of the Home screen.

If the device loses satellite signals,  disappears and a flashing question mark appears over  on the chart.

For more information about GPS, go to [www.garmin.com/aboutGPS](http://www.garmin.com/aboutGPS). For help acquiring satellite signals, see *My device will not acquire GPS signals*, page 53.

### Selecting the GPS Source

You can select your preferred source for GPS data, if you have more than one GPS source.

- 1 Select **Settings > System > GPS > Source**.
- 2 Select the source for GPS data.

## Customizing the Chartplotter

### Home Screen

The chartplotter home screen provides access to all of the features in the chartplotter. The features are dependant on the accessories you have connected to the chartplotter. You may not have all of the options and features discussed in this manual.

The categories along the right of the screen provide quick access to the main features of your chartplotter. For example, the Sonar category displays the views and pages related to the sonar feature. You can save items you commonly access to the Favorites category.

All of the options along the bottom of the home screen are visible on all other screens, except for the Settings button. The Settings button is accessible only from the home screen.

When viewing another screen, you can return to the home screen by selecting HOME.

When multiple displays are installed on the Garmin Marine Network, you can group them together into a station. A station enables the displays to work together, instead of as several separate displays. You can customize the layout of the pages on each display, making each page different on each display. When you change the layout of a page in one display, the changes appear on only that display. When you change the name and symbol of the layout, those changes appear on all displays in the station, to maintain a consistent appearance.

The SmartMode™ items are geared toward an activity, such as cruising or docking. When a SmartMode button is selected from the home screen, each display in the station can show unique information. For example, when Cruising is selected from the home screen, one display can show the navigation chart and another display can show the radar screen.

### Adding an Item to the Favorites Screen

You can add items such as a chart, combo screen, or gauge to your favorites screen.

Highlight an item, and hold **SELECT**.

The selected item appears on your favorites screen.

### Customizing the Favorites Screen

You can add items to and rearrange items on the Favorites screen.

- 1 From the Favorites screen, select **MENU**
- 2 Select an option:
  - To rearrange an item, select **Rearrange** and use the arrow keys to select the new location.
  - To remove an item you have added to the Favorites screen, select **Remove Favorite**, highlight the item, and select **SELECT**.

## Customizing Pages

### Customizing the Layout of a SmartMode or Combination Page

You can customize the layout and data shown in the combination pages and SmartMode layouts. When you change the layout of a page in a display you are interacting with, the change appears only on that display, except for the SmartMode name and symbol. When you change the SmartMode name or symbol for the layout, the new name or symbol appears on all displays in the station.

- 1 Open a page to customize.
- 2 Select **MENU**.
- 3 Select **Edit Layout** or **Edit Combo**.
- 4 Select an option:
  - To change the name, select **Name** or **Name & Symbol > Name**, enter a new name, and select **Done**.
  - To change the SmartMode symbol, select **Name & Symbol > Symbol**, and select a new symbol.
  - To change the number of functions shown and the layout of the screen, select **Layout**, and select an option.
  - To change the function of a portion of the screen, select the window to change, and select a function from the list on the right.
  - To change how the screens are split, use the arrow keys to select a new location.
  - To change the data shown on the page and additional data bars, select **Overlays**, and select an option.
  - To assign a preset to a portion of the SmartMode screen, select **Presets > Include**, and select a preset from the list on the right.

### Adding a SmartMode Layout

You can add SmartMode layouts to suit your needs. Each customization made to one SmartMode layout for the home screen in a station appears on all displays in the station.

- 1 From the home screen, select **SmartMode™ > MENU > Add Layout**.
- 2 Select an option:
  - To change the name, select **Name & Symbol > Name**, enter a new name, and select **Done**.

- To change the SmartMode symbol, select **Name & Symbol** > **Symbol**, and select a new symbol.
- To change the number of functions shown and the layout of the screen, select **Layout**, and select an option.
- To change the function of a portion of the screen, select the window to change, and select a function from the list on the right.
- To change how the screens are split, use the arrow keys to select a new location.
- To change the data shown on the page and additional data bars, select **Overlays**, and select an option.
- To assign a preset to a portion of the SmartMode screen, select **Presets** > **Include**, and select a preset from the list on the right.

## Creating a New Combination Page

You can create a custom combination page to suit your needs.

- 1 Select **Combos** > **MENU** > **Add Combo**.
- 2 Select a window.
- 3 Select a function for the window.
- 4 Repeat these steps for each window of the page.
- 5 Drag the arrows to resize the windows.
- 6 Hold a window to rearrange it.
- 7 Hold a data field to select new data.
- 8 Select **Layout**, and select a layout.

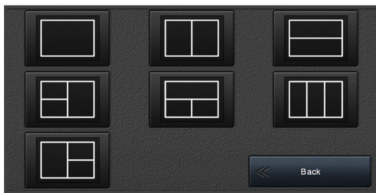

- 9 Select **Name**, enter a name for the page, and select **Done**.
- 10 Select **Overlays**, and select which data to show.
- 11 Select **Done** when you have finished customizing the page.

## Deleting a Combination Page

- 1 Select **Combos** > **MENU** > **Delete Combo**.
- 2 Select a combination.

## Customizing the Data Overlays

You can customize the data shown on a screen.

- 1 Select an option based on the type of screen you are viewing:
  - From a full screen view, select **MENU** > **Edit Overlays**.
  - From a combination screen, select **MENU** > **Edit Combo** > **Overlays**.
  - From a SmartMode screen, select **MENU** > **Edit Layout** > **Overlays**.

**TIP:** To quickly change the data shown in an overlay box, hold the overlay box.

- 2 Select an item to customize the data and data bar:
  - To change the data shown in an overlay box, select the overlay box, select the new data to show, and select **BACK**.
  - To select the location and layout of the data overlay bar, select **Data**, and select an option.
  - To customize the information shown when navigating, select **Navigation**, and select an option.
  - To turn on other data bars, like the media controls, select **Top Bar** or **Bottom Bar**, and select the necessary options.

- 3 Select **Done**.

## Resetting the Station Layouts

You can restore the factory default layouts for all stations.

Select **Settings** > **System** > **Station Information** > **Reset Stations**.

## Assigning a Shortcut Key

You can quickly open commonly used screens by assigning a shortcut key. You can create a shortcut to screens such as sonar screens and charts.

- 1 Open a screen.
- 2 Hold a shortcut key, and select **OK**.

**TIP:** The shortcut is also saved to the Favorites category with the shortcut key number.

## Presets

A preset is a collection of settings that optimize the screen or view. You can use particular presets to optimize groups of settings for your activity. For example, some settings might be optimal for when you are fishing, and others might be optimal for when you are cruising. Presets are available on some screens, such as charts, sonar views, and radar views.

To select a preset for a compatible screen, select **MENU** > **!★**, and select the preset.

When you are using a preset and you make changes to the settings or view, you can save the changes to the preset or create a new preset based on the new customizations.

## Saving a New Preset

After you have customized the settings and view of a screen, you can save the customization as a new preset.

- 1 From a compatible screen, change the settings and view.
- 2 Select **MENU** > **!★** > **Save** > **New**.
- 3 Enter a name, and select **Done**.

## Managing Presets

You can customize the pre-loaded presets and edit presets you created.

- 1 From a compatible screen, select **MENU** > **!★** > **Manage**.
- 2 Select a preset.
- 3 Select an option:
  - To rename the preset, select **Rename**, enter a name, and select **Done**.
  - To edit the preset, select **Edit**, and update the preset.
  - To delete the preset, select **Delete**.
  - To reset all presets to factory settings, select **Reset All**.

## Setting the Vessel Type

You can select your boat type to configure the chartplotter settings and to use features customized for your boat type.

- 1 Select **Settings** > **My Vessel** > **Vessel Type**.
- 2 Select an option.

## Adjusting the Backlight

- 1 Select **Settings** > **System** > **Display** > **Backlight**.
- 2 Adjust the backlight.

**TIP:** From any screen, press  $\odot$  repeatedly to scroll through the brightness levels. This can be helpful when the brightness is so low you cannot see the screen.

## Adjusting the Color Mode

- 1 Select **Settings** > **System** > **Sounds and Display** > **Color Mode**.

**TIP:** Select  > **Color Mode** from any screen to access the color settings.

- 2 Select an option.

## Customizing the Startup Screen

You can personalize the startup, splash screen on your chartplotter.



- 1 Insert a memory card that contains the image you want to use.
- 2 Select **Settings > System > Sounds and Display > Startup Image > Select Image**.
- 3 Select the memory card slot.
- 4 Select the image.  
For the best results, use an image that is 50 MB or less.
- 5 Select **Set as Startup Image**.

To view the splash screen with the new image, turn the chartplotter off and on.

## Turning On the Chartplotter Automatically

You can set the chartplotter to turn on automatically when the power is applied. Otherwise, you must turn on the chartplotter by pressing .

Select **Settings > System > Auto Power Up**.

**NOTE:** When Auto Power Up is On, and the chartplotter is turned off using , and power is removed and reapplied within less than two minutes, you may need to press  to restart the chartplotter.

## Automatically Turning Off the System

You can set the chartplotter and the whole system to turn off automatically after it has been asleep for the selected length of time. Otherwise, you must press and hold  to turn off the system manually.

- 1 Select **Settings > System > Auto Power Off**.
- 2 Select an option.

## ActiveCaptain App

### CAUTION

This feature allows users to submit information. Garmin makes no representations about the accuracy, completeness, or timeliness of information submitted by users. Any use or reliance on the information submitted by users is at your own risk.

The ActiveCaptain app provides a connection to your GPSMAP device, charts, maps, and the community for a connected boating experience.

On your mobile device with the ActiveCaptain app, you can download, purchase, and update maps and charts. You can use the app to easily and quickly transfer user data, such as waypoints and routes, connect to the Garmin Quickdraw Contours Community, and update device software. You can also plan your trip, and view and control the GPSMAP device from the app.

You can connect to the ActiveCaptain community for up-to-date feedback on marinas and other points of interest. The app can push smart notifications, such as calls and texts, to your chartplotter display when paired.

## ActiveCaptain Roles

Your level of interaction with the GPSMAP device using the ActiveCaptain app depends on your role.

Feature	Owner	Guest
Register device, built-in maps, and supplemental map cards to account	Yes	
Update software	Yes	Yes
Automatically transfer Garmin Quickdraw contours you have downloaded or created	Yes	
Push smart notifications	Yes	Yes
Automatically transfer user data, such as waypoints and routes	Yes	
Begin navigating to a specific waypoint or navigating a specific route, and send that waypoint or route to the GPSMAP device	Yes	Yes

## Getting Started with the ActiveCaptain App

**NOTE:** The ActiveCaptain feature is only available on models that have Wi-Fi® technology.

You can connect a mobile device to the GPSMAP device using the ActiveCaptain app. The app provides a quick and easy way for you to interact with your chartplotter and complete such tasks as sharing data, registering, updating the device software, and receiving mobile device notifications.

- 1 From the GPSMAP device, select **ActiveCaptain**.
- 2 From the **ActiveCaptain** page, select **Wi-Fi Network > Wi-Fi > On**.
- 3 Enter a name and password for this network.
- 4 Insert a memory card in the GPSMAP device's card slot (*Inserting Memory Cards*, page 1).
- 5 Select **Create ActiveCaptain Memory Card**.

### NOTICE

You might be prompted to format the memory card. Formatting the card deletes all information saved on the card. This includes any saved user data, such as waypoints. Formatting the card is recommended, but not required. Before formatting the card, you should save the data from the memory card onto the device internal memory (*Copying User Data from a Memory Card*, page 51). After formatting the card for the ActiveCaptain app, you can transfer the user data back to the card (*Copying User Data to a Memory Card*, page 51).

Be sure the card is inserted each time you want to use the ActiveCaptain feature.

- 6 From the application store on your mobile device, install and open the ActiveCaptain app.
- 7 Bring the mobile device within 32 m (105 ft.) of the GPSMAP device.
- 8 From your mobile device settings, open the Wi-Fi connections page and connect to the Garmin device, using the name and password you entered in the Garmin device.

## Receiving Smart Notifications

With the ActiveCaptain app, the GPSMAP device can show notifications received from your mobile device.

- 1 From the GPSMAP device, select **ActiveCaptain > Smart Notifications > Enable Notifications**.
- 2 Turn on Bluetooth® technology in the mobile device settings.
- 3 Bring the devices within 10 m (33 ft.) of each other.
- 4 From the ActiveCaptain app on the mobile device, select **Smart Notifications > Pair with Chartplotter**.
- 5 Follow the on-screen instructions to pair the app to the GPSMAP device using Bluetooth technology.
- 6 When prompted, enter the key on your mobile device.
- 7 If necessary, adjust the notifications in your mobile device settings.

## Updating Software with the ActiveCaptain App

If your device has Wi-Fi technology, you can use the ActiveCaptain app to download and install the latest software updates for your device.

### NOTICE

Software updates may require the app to download large files. Regular data limits or charges from your Internet service provider apply. Contact your Internet service provider for more information about data limits or charges.

The installation process can take several minutes.

- 1 Connect the mobile device to the GPSMAP device ([Getting Started with the ActiveCaptain App, page 4](#)).
- 2 When a software update is available and you have internet access on your mobile device, select **Software Updates > Download**.  
The ActiveCaptain app downloads the update to the mobile device. When you reconnect the app to the GPSMAP device, the update is transferred to the device. After the transfer is complete, you are prompted to install the update.
- 3 When you are prompted by the GPSMAP device, select an option to install the update.
  - To update the software immediately, select **OK**.
  - To delay the update, select **Cancel**. When you are ready to install the update, select **ActiveCaptain > Software Updates > Install Now**.

## Updating Charts with ActiveCaptain

You can use the ActiveCaptain app to download and transfer the latest chart updates for your device. To save space on your mobile device, space on the ActiveCaptain card, and download time, consider using the ActiveCaptain app to download only the areas of the chart you need.

If you are downloading an entire chart, you can use the Garmin Express™ app to download the map onto a memory card. The Garmin Express app downloads large charts more quickly than the ActiveCaptain app. For more information, go to [garmin.com/express](http://garmin.com/express).

### NOTICE

Chart updates may require the app to download large files. Regular data limits or charges from your internet service provider apply. Contact your internet service provider for more information about data limits or charges.

- 1 Connect the mobile device to the GPSMAP device ([Getting Started with the ActiveCaptain App, page 4](#)).
- 2 When a chart update is available, and you have internet access on your mobile device, select **OneChart > My Charts**.
- 3 Select the map to update.
- 4 Select the area to download.
- 5 Select **Download**.  
The ActiveCaptain app downloads the update to the mobile device. When you reconnect the app to the GPSMAP device, the update is transferred to the device. After the transfer is complete, the updated charts are available for use.

## Communication with Wireless Devices

The chartplotters can create a wireless network to which you can connect wireless devices.

Connecting wireless devices allows you to use Garmin apps, such as ActiveCaptain.

## Wi-Fi Network

### Setting Up the Wi-Fi Wireless Network

The chartplotters can create a Wi-Fi network to which you can connect wireless devices. The first time you access the wireless network settings, you are prompted to set up the network.

- 1 Select **Settings > Communications > Wi-Fi Network > Wi-Fi > On > OK**.
- 2 If necessary, enter a name for this wireless network.
- 3 Enter a password.

You will need this password to access the wireless network from a wireless device. The password is case-sensitive.

### Connecting a Wireless Device to the Chartplotter

Before you can connect a wireless device to the chartplotter wireless network, you must configure the chartplotter wireless network ([Setting Up the Wi-Fi Wireless Network, page 5](#)).

You can connect multiple wireless devices to the chartplotter to share data.

- 1 From the wireless device, turn on the Wi-Fi technology and search for wireless networks.
- 2 Select the name of your chartplotter wireless network ([Setting Up the Wi-Fi Wireless Network, page 5](#)).
- 3 Enter the network password.

### Changing the Wireless Channel

You can change the wireless channel if you have trouble finding or connecting to a device, or if you experience interference.

- 1 Select **Settings > Communications > Wi-Fi Network > Advanced > Channel**.
- 2 Enter a new channel.

You do not need to change the wireless channel of devices connected to this network.

### Changing the Wi-Fi Host

You can change which chartplotter is serving as the Wi-Fi host. This can be helpful if you are having trouble with Wi-Fi communications. Changing the Wi-Fi host allows you to select a chartplotter that is physically closer to your mobile device.

- 1 Select **Settings > Communications > Wireless Devices > Wi-Fi Network > Advanced > Wi-Fi Host**.
- 2 Follow the on-screen instructions.

## Wireless Remote Control

### Pairing the Wireless Remote Control With the Chartplotter

Before you can use the wireless remote control with a chartplotter, you must pair the remote with the chartplotter.

You can connect a single remote to multiple plotters, and then press the pairing key to switch between the chartplotters.

- 1 Select **Settings > Communications > Wireless Devices > Wireless Remote**.
- 2 Select **New Connection**.
- 3 Follow the on-screen instructions.

### Turning On and Off the Remote Backlight

Turning off the remote backlight can significantly increase the battery life.

- 1 On the chartplotter, select **Settings > Communications > Wireless Devices > Wireless Remote > Backlight**.
- 2 Follow the on-screen instructions.

### Disconnecting the Remote from All Chartplotters

- 1 On the chartplotter, select **Settings > Communications > Wireless Devices > Wireless Remote > Disconnect All**.

- 2 Follow the on-screen instructions.

## Wireless Wind Sensor

### Connecting a Wireless Sensor to the Chartplotter

You can view data from a compatible wireless sensor on the chartplotter.

- 1 Select **Settings > Communications > Wireless Devices**.
- 2 Select the wind sensor.
- 3 Select **Enable**.

The chartplotter begins searching for and connecting to the wireless sensor.

To view data from the sensor, add the data to a data field or gauge.

### Adjusting the Wind Sensor Orientation

You should adjust this setting if the sensor does not face the front of the boat, exactly parallel to the center line.

**NOTE:** The opening where the cable connects to the pole indicates the front of the sensor.

- 1 Estimate the angle, in degrees clockwise around the mast, by which the sensor points away from the center of the front of the boat:
  - If the sensor is facing starboard, the angle should be between 1 and 180 degrees.
  - If the sensor is facing port, the angle should be between -1 and -180 degrees.
- 2 Select **Settings > Communications > Wireless Devices**.
- 3 Select the wind sensor.
- 4 Select **Wind Angle Offset**.
- 5 Enter the angle observed in step 1.
- 6 Select **Done**.

## Connecting a quatix® Watch to the Chartplotter

You can connect a compatible quatix watch, such as the quatix 3 watch, to a compatible chartplotter to view data from the chartplotter on your quatix watch.

- 1 Bring the quatix watch within range (3 m) of the chartplotter.
- 2 From the quatix watch clock screen, select **START > Boat Data > START**.

**NOTE:** If you have already connected to a chartplotter, and would like to connect to a different chartplotter, open the Boat Data screen, hold UP, and select Pair new.

- 3 On the chartplotter, select **Settings > Communications > Wireless Devices > Garmin Wearable > Enable Connections > New Connection**.

The chartplotter begins searching for and connecting to the wearable device.

After the devices are paired, they connect automatically when they are turned on and within range.

## Connecting a Garmin Nautix™ Device to the Chartplotter

Pairing is the initial connection of two compatible wireless devices. For example, the first time you connect a Garmin Nautix device to a compatible chartplotter you are pairing the devices. For a list of compatible devices, go to the product page at [www.garmin.com](http://www.garmin.com).

**NOTE:** You can pair a Garmin Nautix device to multiple compatible devices for better coverage on larger vessels.

- 1 Bring the a Garmin Nautix device within range (3 m) of the chartplotter.

The device automatically looks for all compatible devices within range.

- 2 If necessary, from the wearable device menu, select **Device Connections > Pair New Device**.
- 3 On the chartplotter, select **Settings > Communications > Wireless Devices > Garmin Wearable > Enable Connections > New Connection**.

The chartplotter begins searching for and connecting to the wearable device.

After the devices are paired, they connect automatically when they are turned on and within range.

## Charts and 3D Chart Views

The charts and 3D chart views that are available depend on the map data and accessories used.

You can access the charts and 3D chart views by selecting Charts.

**Navigation Chart:** Shows navigation data available on your pre-loaded maps and from supplemental maps, if available. The data includes buoys, lights, cables, depth soundings, marinas, and tide stations in an overhead view.

**Perspective 3D:** Provides a view from above and behind the boat (according to your course) and provides a visual navigation aid. This view is helpful when navigating tricky shoals, reefs, bridges, or channels, and is beneficial when trying to identify entry and exit routes in unfamiliar harbors or anchorages.

**Mariner's Eye 3D:** Shows a detailed, three-dimensional view from above and behind the boat (according to your course) and provides a visual navigation aid. This view is helpful when navigating tricky shoals, reefs, bridges, or channels, and when trying to identify entry and exit routes in unfamiliar harbors or anchorages.

**NOTE:** 3D chart views are available with premium charts, in some areas.

**Fish Eye 3D:** Provides an underwater view that visually represents the sea floor according to the chart information. When a sonar transducer is connected, suspended targets (such as fish) are indicated by red, green, and yellow spheres. Red indicates the largest targets and green indicates the smallest.

**Fishing Chart:** Provides a detailed view of the bottom contours and depth soundings on the chart. This chart removes navigational data from the chart, provides detailed bathymetric data, and enhances bottom contours for depth recognition. This chart is best for offshore deep-sea fishing.

**NOTE:** The Fishing chart is available with premium charts, in some areas.

**Radar Overlay:** Superimposes radar information on the Navigation chart or the Fishing chart, when the chartplotter is connected to a radar. This feature is not available with all models.

## Navigation Chart and Fishing Chart

**NOTE:** The Fishing chart is available with premium charts, in some areas.

The Nav. Chart is optimized for navigation. You can plan a course, view map information, and use the chart as a navigational aid. To open the Nav. Chart, select **Charts > Nav. Chart**.

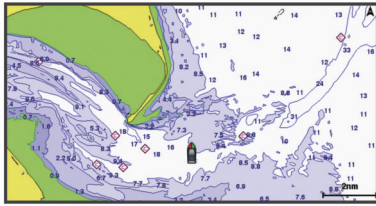

The Fishing Chart provides a detailed view with more bottom detail and fishing content. This chart is optimized for use when fishing. To open the Fishing Chart, select **Charts > Fishing Chart**.

### Chart Symbols

This table contains some of the common symbols you might see on the detailed charts.

Icon	Description
	Buoy
	Information
	Marine services
	Tide station
	Current station
	Overhead photo available
	Perspective photo available

Other features common to most charts include depth contour lines, intertidal zones, spot soundings (as depicted on the original paper chart), navigational aids and symbols, obstructions, and cable areas.

### Selecting an Item on the Map Using the Device Keys

- From a chart or 3D chart view, select **←**, **→**, **↓**, or **↑** to move the cursor.
- Select **SELECT**.

### Measuring a Distance on the Chart

- From a chart or the Radar overlay, select a location.
- Select **Measure**.

A push pin appears on the screen at your present location. The distance and angle from the pin is listed in the corner.

**TIP:** To reset the pin and measure from the current location of the cursor, select **SELECT**.

### Creating a Waypoint on the Chart

- From a chart, select a location or object.
- Select **Create Waypoint**.

### Viewing Location and Object Information on a Chart

You can view information, such as tide, current, celestial, chart notes, or local services, about a location or an object on the Navigation chart or the Fishing chart.

- From the Navigation chart or Fishing chart, select a location or object.

A list of options appears along the top of the chart. The options that appear vary based on the location or object you selected.

- Select **Information**.

### Viewing Details about Nav aids

From the Navigation chart, Fishing chart, Perspective 3D chart view, or Mariner's Eye 3D chart view, you can view details about various types of navigation aids, including beacons, lights, and obstructions.

**NOTE:** The Fishing chart is available with premium charts, in some areas.

**NOTE:** 3D chart views are available with premium charts, in some areas.

- From a chart or 3D chart view, select a navaid.
- Select the name of the navaid.

### Navigating to a Point on the Chart

#### ⚠ CAUTION

The Auto Guidance feature is based on electronic chart information. That data does not ensure obstacle and bottom clearance. Carefully compare the course to all visual sightings, and avoid any land, shallow water, or other obstacles that may be in your path.

When using Go To, a direct course and a corrected course may pass over land or shallow water. Use visual sightings, and steer to avoid land, shallow water, and other dangerous objects.

**NOTE:** The Fishing chart is available with premium charts, in some areas.

**NOTE:** Auto Guidance is available with premium charts, in some areas.

- From the Navigation chart or Fishing chart, select a location.
- If necessary, select **Navigate To**.
- Select an option:
  - To navigate directly to the location, select **Go To** or
  - To create a route to the location, including turns, select **Route To** or
  - To use Auto Guidance, select **Auto Guidance** or

- Review the course indicated by the magenta line.

**NOTE:** When using Auto Guidance, a gray segment within any part of the magenta line indicates that Auto Guidance cannot calculate part of the Auto Guidance line. This is due to the settings for minimum safe water depth and minimum safe obstacle height.

- Follow the magenta line, steering to avoid land, shallow water, and other obstacles.

### Premium Charts

#### ⚠ CAUTION

The Auto Guidance feature is based on electronic chart information. That data does not ensure obstacle and bottom clearance. Carefully compare the course to all visual sightings, and avoid any land, shallow water, or other obstacles that may be in your path.

**NOTE:** Not all models support all charts.

Optional premium charts, such as BlueChart® g2 Vision®, allow you to get the most out of your chartplotter. In addition to detailed marine charting, premium charts may contain these features, which are available in some areas.

**Mariner's Eye 3D:** Provides a view from above and behind the boat for a three-dimensional navigation aid.

**Fish Eye 3D:** Provides an underwater, three-dimensional view that visually represents the sea floor according to the information on the chart.

**Fishing Charts:** Shows the chart with enhanced bottom contours and without navigational data. This chart works well for offshore deep-sea fishing.

**High Resolution Satellite Imagery:** Provides high-resolution satellite images for a realistic view of the land and water on the Navigation chart (*Showing Satellite Imagery on the Navigation Chart*, page 8).

**Aerial Photos:** Shows marinas and other navigationally significant aerial photos to help you visualize your

surroundings (*Viewing Aerial Photos of Landmarks, page 8*).

**Detailed Roads and POI data:** Shows detailed road and point of interest (POI) data, which includes highly detailed coastal roads and POIs such as restaurants, lodging, and local attractions.

**Auto Guidance:** Uses specified information about your vessel and chart data to determine the best path to your destination.

### Viewing Tide Station Information

◆ on the chart indicates a tide station. You can view a detailed graph for a tide station to help predict the tide level at different times or on different days.

**NOTE:** This feature is available with premium charts, in some areas.

1 From the Navigation chart or Fishing chart, select a tide station.

Tide direction and tide level information appear near ◆.

2 Select the station name.

### Animated Tide and Current Indicators

**NOTE:** This feature is available with premium charts, in some areas.

You can view indicators for animated tide station and current direction on the Navigation chart or the Fishing chart. You must also enable animated icons in the chart settings (*Showing Tides and Current Indicators, page 8*).

An indicator for a tide station appears on the chart as a vertical bar graph with an arrow. A red arrow pointing downward indicates a falling tide, and a blue arrow pointing upward indicates a rising tide. When you move the cursor over the tide station indicator, the height of the tide at the station appears above the station indicator.

Current direction indicators appear as arrows on the chart. The direction of each arrow indicates the direction of the current at a specific location on the chart. The color of the current arrow indicates the range of speed for the current at that location. When you move the cursor over the current direction indicator, the specific current speed at the location appears above the direction indicator.

Color	Current Speed Range
Yellow	0 to 1 knot
Orange	1 to 2 knots
Red	2 or more knots

### Showing Tides and Current Indicators

**NOTE:** This feature is available with premium charts, in some areas.

You can show static or animated tide and current station indicators on the Navigation chart or Fishing chart.

1 From the Navigation or Fishing chart, select **MENU > Layers > Chart > Tides & Currents**.

2 Select an option:

- To show animated tide station indicators and animated current direction indicators on the chart, select **Animated**.
- To enable the tides and current slider, which sets the time for which tides and currents are reported on the map, select **Slider**.

### Showing Satellite Imagery on the Navigation Chart

**NOTE:** This feature is available with premium charts, in some areas.

You can overlay high-resolution satellite images on the land or on both land and sea portions of the Navigation chart.

**NOTE:** When enabled, high-resolution satellite images are present only at lower zoom levels. If you cannot see high-

resolution images in your optional chart region, you can select + to zoom in. You also can set the detail level higher by changing the map zoom detail.

1 From the Navigation chart, select **MENU > Layers > Satellite Photos**.

2 Select an option:

- Select **Land Only** to show standard chart information on the water, with photos overlaying the land.
- Select **Photo Map** to show photos on both the water and the land at a specified opacity. Use the slider bar to adjust the photo opacity. The higher you set the percentage, the more the satellite photos cover both land and water.



### Viewing Aerial Photos of Landmarks

Before you can view aerial photos on the Navigation chart, you must turn on the Satellite Photos setting in the chart setup.

**NOTE:** This feature is available with premium charts, in some areas.

You can use aerial photographs of landmarks, marinas, and harbors to help orient yourself to your surroundings or to acquaint yourself with a marina or a harbor prior to arrival.

1 From the Navigation chart, select a camera icon:

- To view an overhead photo, select .
- To view a perspective photo, select . The photo was taken from the location of the camera, pointed in the direction of the cone.

2 Select **Aerial Photo**.





### Automatic Identification System

The Automatic Identification System (AIS) enables you to identify and track other vessels, and alerts you to area traffic. When connected to an external AIS device, the chartplotter can show some AIS information about other vessels that are within range, that are equipped with a transponder, and that are actively transmitting AIS information.



The information reported for each vessel includes the Maritime Mobile Service Identity (MMSI), location, GPS speed, GPS heading, time that has elapsed since the last position of the vessel was reported, nearest approach, and time to the nearest approach.

Some chartplotter models also support Blue Force Tracking. Vessels being tracked with Blue Force Tracking are indicated on the chartplotter with a blue-green color.

### AIS Targeting Symbols

Symbol	Description
	AIS vessel. The vessel is reporting AIS information. The direction in which the triangle is pointing indicates the direction in which the AIS vessel is moving.
	Target is selected.
	Target is activated. The target appears larger on the chart. A green line attached to the target indicates the heading of the target. The MMSI, speed, and direction of the vessel appear beneath the target, if the details setting has been set to Show. If the AIS transmission from the vessel is lost, a message banner appears.
	Target is lost. A green X indicates that the AIS transmission from the vessel is lost, and the chartplotter displays a message banner asking whether the vessel should continue to be tracked. If you discontinue vessel tracking, the lost target symbol disappears from the chart or the 3D chart view.



Symbol	Description
	Dangerous target in range. The target flashes while an alarm sounds and a message banner appears. After the alarm has been acknowledged, a solid red line with a red line attached to it indicates the location and the heading of the target. If the safe-zone collision alarm has been set to Off, the target flashes, but the audible alarm does not sound and the alarm banner does not appear. If the AIS transmission from the vessel is lost, a message banner appears.
	Dangerous target is lost. A red X indicates that the AIS transmission from the vessel is lost, and the chartplotter displays a message banner asking whether the vessel should continue to be tracked. If you discontinue vessel tracking, the lost dangerous target symbol disappears from the chart or the 3D chart view.
	The location of this symbol indicates the closest point of approach to a dangerous target, and the numbers near the symbol indicate the time to the closest point of approach to that target.

**NOTE:** Vessels being tracked with the Blue Force Tracking feature are indicated with a blue-green color regardless of their status.

### Heading and Projected Course of Activated AIS Targets

When heading and course over ground information are provided by an activated AIS target, the heading of the target appears on a chart as a solid line attached to the AIS target symbol. A heading line does not appear on a 3D chart view.

The projected course of an activated AIS target appears as a dashed line on a chart or a 3D chart view. The length of the projected course line is based on the value of the projected heading setting. If an activated AIS target is not transmitting speed information, or if the vessel is not moving, a projected course line does not appear. Changes in the speed, course over ground, or rate of turn information transmitted by the vessel can impact the calculation of the projected course line.

When course over ground, heading, and rate of turn information are provided by an activated AIS target, the projected course of the target is calculated based on the course over ground and the rate of turn information. The direction in which the target is turning, which is also based on the rate of turn information, is indicated by the direction of the barb at the end of the heading line. The length of the barb does not change.



When course over ground and heading information are provided by an activated AIS target, but rate of turn information is not provided, the projected course of the target is calculated based on the course over ground information.

### Activating a Target for an AIS Vessel

- 1 From a chart or a 3D chart view, select an AIS vessel.
- 2 Select **AIS Vessel > Activate Target**.

### Viewing Information about a Targeted AIS Vessel

You can view the AIS signal status, MMSI, GPS speed, GPS heading, and other information that is reported about a targeted AIS vessel.

- 1 From a chart or a 3D chart view, select an AIS vessel.
- 2 Select **AIS Vessel**.

### Deactivating a Target for an AIS Vessel

- 1 From a chart or a 3D chart view, select an AIS vessel.
- 2 Select **AIS Vessel > Deactivate**.

### Viewing a List of AIS and MARPA Threats

- 1 From a chart, select **MENU > Layers > Other Vessels > List > Show**.
- 2 Select the type of threats to include in the list.

### Setting the Safe-Zone Collision Alarm

Before you can set a collision alarm, you must have a compatible chartplotter connected to an AIS device or radar.

The safe-zone collision alarm is used only with AIS and MARPA. MARPA functionality works with radar. The safe zone is used for collision avoidance and can be customized.

- 1 Select **Settings > Alarms > Collision Alarm > On**.

A message banner appears and an alarm sounds when a MARPA-tagged object or an AIS-activated vessel enters the safe-zone area around your boat. The object is also labeled as dangerous on the screen. When the alarm is off, the message banner and audible alarm are disabled, but the object is still labeled as dangerous on the screen.

- 2 Select **Range**.
- 3 Select a distance for the safe-zone radius around your vessel.
- 4 Select **Time To**.
- 5 Select a time at which the alarm will sound if a target is determined to intersect the safe zone.

For example, to be notified of a pending intersection 10 minutes before it will likely occur, set Time To to 10, and the alarm will sound 10 minutes before the vessel intersects the safe zone.

### AIS Distress Signals





Self-contained AIS distress signal devices transmit emergency position reports when activated. The chartplotter can receive signals from Search and Rescue Transmitters (SART), Emergency Position Indicating Radio Beacons (EPIRB), and other man overboard signals. Distress signal transmissions are different than standard AIS transmissions, so they appear differently on the chartplotter. Instead of tracking a distress signal transmission for collision avoidance, you track a distress signal transmission to locate and assist a vessel or person.

### Navigating to a Distress Signal Transmission

When you receive a distress signal transmission, a distress signal alarm appears.

Select **Review > Go To** to begin navigation to the transmission.

### AIS Distress Signal Device Targeting Symbols

Symbol	Description
	AIS distress signal device transmission. Select to see more information about the transmission and begin navigation.
	Transmission lost.
	Transmission test. Appears when a vessel initiates a test of their distress signal device, and does not represent a true emergency.
	Transmission test lost.

### Enabling AIS Transmission Test Alerts

To avoid a large number of test alerts and symbols in crowded areas such as marinas, you can select to receive or ignore AIS test messages. To test an AIS emergency device, you must enable the chartplotter to receive test alerts.

- 1 Select **Settings > Alarms > AIS**.
- 2 Select an option:
  - To receive or ignore Emergency Position Indicating Radio Beacon (EPIRB) test signals, select **AIS-EPIRB Test**.
  - To receive or ignore Man Overboard (MOB) test signals, select **AIS-MOB Test**.

- To receive or ignore Search and Rescue Transponder (SART) test signals, select **AIS-SART Test**.

## Turning Off AIS Reception

AIS signal reception is turned on by default.

Select **Settings > Other Vessels > AIS > Off**.

All AIS functionality on all charts and 3D chart views is disabled. This includes AIS vessel targeting and tracking, collision alarms that result from AIS vessel targeting and tracking, and the display of information about AIS vessels.

## Chart Menu

**NOTE:** Not all settings apply to all charts. Some options require premium maps or connected accessories, such as radar.

From a chart, select **MENU**.

**Layers:** Adjusts the appearance of the different items on the charts ([Chart Layers, page 10](#)).

**Quickdraw Contours:** Turns on bottom contour drawing, and allows you to create fishing map labels ([Garmin Quickdraw Contours Mapping, page 11](#)).

**Settings:** Adjusts the chart settings ([Chart Settings, page 11](#)).

**Edit Overlays:** Adjusts the data shown on the screen ([Customizing the Data Overlays, page 3](#)).

## Chart Layers

The layers in the charts allow you to turn on and off and customize features of the charts. Each setting is specific to the chart or chart view being used.

**NOTE:** Not all settings apply to all charts and chartplotter models. Some options require premium maps or connected accessories.

From a chart, select **MENU > Layers**.

**Chart:** Shows and hides chart related items ([Chart Layer Settings, page 10](#)).

**My Vessel:** Shows and hides items relating to the boat ([My Vessel Layer Settings, page 10](#)).

**User Data:** Shows and hides user data, such as waypoints, boundaries, and tracks, and opens user data lists ([User Data Layer Settings, page 10](#)).

**Other Vessels:** Adjusts how other vessels are shown ([Other Vessels Layer Settings, page 11](#)).

**Water:** Shows and hides depth items ([Water Layer Settings, page 11](#)).

**Quickdraw Contours:** Shows and hides Garmin Quickdraw data ([Garmin Quickdraw Contours Settings, page 13](#)).

**Tracks:** Shows and hides tracks on the 3D chart view.

**Range Rings:** Shows and configures the appearance of range rings on the 3D chart view. Range Rings help you to visualize distances in some chart views.

## Chart Layer Settings

From a chart, select **MENU > Layers > Chart**.

**Satellite Photos:** Shows high-resolution satellite images on the land or on both land and sea portions of the Navigation chart, when certain premium maps are used ([Showing Satellite Imagery on the Navigation Chart, page 8](#)).

**Tides & Currents:** Shows current station indicators and tide station indicators on the chart ([Showing Tides and Current Indicators, page 8](#)) and enables the tides and current slider, which sets the time for which tides and currents are reported on the map.

**Nav aids:** Shows navigational aids on the chart.

**Land POIs:** Shows points of interest on land.

**Photo Points:** Shows camera icons for aerial photos ([Viewing Aerial Photos of Landmarks, page 8](#)).

**Service Points:** Shows locations for marine services.

**Depth:** Adjusts the items on the depth layer ([Depth Layer Settings, page 10](#)).

## Depth Layer Settings

From a chart, select **MENU > Layers > Chart > Depth**.

**Depth Shading:** Specifies an upper and lower depth to shade between.

**Shallow Shading:** Sets the shades from the shoreline to the specified depth.

**Spot Depths:** Turns on spot soundings and sets a dangerous depth. Spot depths that are equal to or more shallow than the dangerous depth are indicated by red text.

**Fishing Contours:** Sets the zoom level for a detailed view of bottom contours and depth soundings and simplifies map presentation for optimal use while fishing.

## My Vessel Layer Settings

From a chart, select **MENU > Layers > My Vessel**.

**Heading Line:** Shows and adjusts the heading line, which is a line drawn on the map from the bow of the boat in the direction of travel ([Setting the Heading Line and Angle Markers, page 21](#)).

**Active Tracks:** Shows the active track on the chart and opens the Active Track Options menu.

**Wind Rose:** Shows a visual representation of the wind angle or direction provided by the connected wind sensor and sets the wind source.

**Compass Rose:** Shows a compass rose around your boat, indicating compass direction oriented to the heading of the boat. Enabling this option disables the Wind Rose option.

**Vessel Icon:** Sets the icon that represents your present location on the chart.

## Laylines Settings

To use the laylines features, you must connect a wind sensor to the chartplotter.

When in sailing mode [Setting the Vessel Type, page 3](#), you can display laylines on the navigation chart. Laylines can be very helpful when racing.

From the navigation chart, select **MENU > Layers > My Vessel > Laylines > Setup**.

**Display:** Sets how the laylines and vessel appear on the chart, and sets the length of the laylines.

**Sailing Ang.:** Allows you to select how the device calculates laylines. The Actual option calculates the laylines using the measured wind angle from the wind sensor. The Manual option calculates the laylines using manually entered windward and leeward angles.

**Windward Ang.:** Allows you to set a layline based on the windward sailing angle.

**Leeward Ang.:** Allows you to set a layline based on the leeward sailing angle.

**Tide Correction:** Corrects the laylines based on the tide.

**Layline Filter:** Filters the layline data based on the time interval entered. For a smoother layline that filters out some of the changes in the boat's heading or true wind angle, enter a higher number. For laylines that display a higher sensitivity to changes in the boat's heading or true wind angle, enter a lower number.

## User Data Layer Settings

You can show user data, such as waypoints, boundaries, and tracks, on the charts.

From a chart, select **MENU > Layers > User Data**.

**Waypoints:** Shows waypoints on the chart and opens the list of waypoints.

**Boundaries:** Shows boundaries on the chart and opens the list of boundaries.

**Tracks:** Shows tracks on the chart.

### **Other Vessels Layer Settings**

**NOTE:** These options require connected accessories, such as an AIS receiver, radar, or VHF radio.

From a chart, select **MENU > Layers > Other Vessels**.

**DSC:** Sets how DSC vessels and trails appear on the chart, and shows the DSC list.

**AIS:** Sets how AIS vessels and trails appear on the chart, and shows the AIS list.

**MARPA:** Sets how MARPA vessels and trails appear on the chart, and shows the MARPA list.

**Details:** Shows other vessel details on the chart.

**Proj. Heading:** Sets the projected heading time for AIS-activated and MARPA-tagged vessels.

**Collision Alarm:** Sets the safe-zone collision alarm ([Setting the Safe-Zone Collision Alarm, page 9](#)).

### **Water Layer Settings**

From a chart, select **MENU > Layers > Water**.

**Depth Shading:** Specifies an upper and lower depth to shade between.

**Shallow Shading:** Sets the shades from the shoreline to the specified depth.

**Spot Depths:** Turns on spot soundings and sets a dangerous depth. Spot depths that are equal to or more shallow than the dangerous depth are indicated by red text.

**Fishing Contours:** Sets the zoom level for a detailed view of bottom contours and depth soundings and simplifies map presentation for optimal use while fishing.

**Relief Shading:** Shows the gradient of the bottom with shading. This feature is available only with some premium maps.

**Sonar Imagery:** Shows sonar imagery to help show the density of the bottom. This feature is available only with some premium maps.

**Lake Level:** Sets the present water level of the lake. This feature is available only with some premium maps.

### **Weather Layer Settings**

From the Navigation or Fishing chart, select **MENU > Layers > Chart > Weather > ☁**.

From a weather chart, select **MENU > Layers > Chart > Weather**.

**Observed Layers:** Sets which observed weather items are shown. Observed weather is the present weather condition that are visible now.

**Forecast Layers:** Sets which forecasted weather items are shown.

**Layer Mode:** Shows forecasted or observed weather information.

**Loop:** Shows a loop of forecasted or observed weather information.

**Legend:** Shows the weather legend, with the severity of the conditions increasing from left to right.

**Weather Subscription:** Shows weather subscription information.

**Restore Defaults:** Resets the weather settings to factory default values.

**Edit Overlays:** Adjusts the data shown on the screen ([Customizing the Data Overlays, page 3](#)).

### **Radar Overlay Settings**

From the Navigation or Fishing chart, select **MENU > Layers > Radar > Ⓜ**.

From a radar screen, select **MENU**.

**Radar To Standby:** Stops radar transmission.

**Gain:** Adjusts the gain ([Adjusting Gain on the Radar Screen Automatically, page 31](#)).

**Sea Clutter:** Adjusts the sea clutter ([Adjusting Gain on the Radar Screen Automatically, page 31](#)).

**Radar Options:** Opens the radar options menu ([Radar Options Menu, page 32](#)).

**Other Vessels:** Sets how other vessels are displayed on the radar view ([Other Vessels Layer Settings, page 11](#)).

**Radar Setup:** Opens the radar display settings ([Radar Setup Menu, page 33](#)).

**Edit Overlays:** Adjusts the data shown on the screen ([Customizing the Data Overlays, page 3](#)).

### **Chart Settings**

**NOTE:** Not all settings apply to all charts and 3D chart views. Some settings require external accessories or applicable premium charts.

From a chart, select **MENU > Settings**.

**Orientation:** Sets the perspective of the map.

**Detail:** Adjusts the amount of detail shown on the map, at different zoom levels.

**World Map:** Uses either a basic world map or a shaded relief map on the chart. These differences are visible only when zoomed out too far to see the detailed charts.

**Start Line:** Sets the starting line for the sailing race.

**Inset Map:** Shows a small map centered on your present location.

### **Fish Eye 3D Settings**

**NOTE:** This feature is available with premium charts, in some areas.

From the Fish Eye 3D chart view, select **MENU**.

**View:** Sets the perspective of the 3D chart view.

**Tracks:** Shows tracks.

**Sonar Cone:** Shows a cone that indicates the area covered by the transducer.

**Fish Symbols:** Shows suspended targets.

## **Supported Maps**

To help you have a safe and enjoyable time on the water, Garmin devices only support official maps produced by Garmin or an approved third party producer.

You can purchase maps from Garmin. If you purchase maps from a seller other than Garmin, investigate the seller before purchasing. Be extra cautious with online sellers. If you have purchased an unsupported map, return it to the seller.

## **Garmin Quickdraw Contours Mapping**

### **⚠ WARNING**

The Garmin Quickdraw Contours mapping feature allows users to generate maps. Garmin makes no representations about the accuracy, reliability, completeness or timeliness of the maps generated by third parties. Any use or reliance on the maps generated by third parties is at your own risk.

The Garmin Quickdraw Contours mapping feature allows you to instantly create maps with contours and depth labels for any body of water.

When Garmin Quickdraw Contours records data, a colored circle surrounds the vessel icon. This circle represents the approximate area of the map that is scanned by each pass.

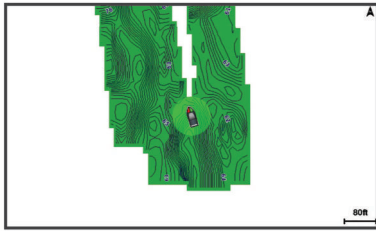

A green circle indicates good depth and GPS position, and a speed under 16 km/h (10 mph). A yellow circle indicates good depth and GPS position, and a speed between 16 and 32 km/h (10 and 20 mph). A red circle indicates poor depth or GPS position, and a speed above 32 km/h (20 mph).

You can view Garmin Quickdraw Contours in a combination screen or as a single view on the map.

The amount of saved data depends on the size of your memory card, your sonar source, and the speed of your boat as you record data. You can record longer when you use a single-beam sonar. It is estimated that you might be able to record about 1,500 hours of data onto a 2 GB memory card.

When you record data on a memory card in your chartplotter, the new data is added to your existing Garmin Quickdraw Contours map, and is saved on the memory card. When you insert a new memory card, the existing data does not transfer onto the new card.

## Mapping a Body of Water Using the Garmin Quickdraw Contours Feature

Before you can use the Garmin Quickdraw Contours feature, you must have sonar depth, your GPS position, and a memory card with free space.

- 1 From a chart view, select **MENU > Quickdraw Contours > Start Recording**.
- 2 When recording is complete, select **MENU > Quickdraw Contours > Stop Recording**.
- 3 Select **Manage > Name**, and enter a name for the map.

## Adding a Label to a Garmin Quickdraw Contours Map

You can add labels to a Garmin Quickdraw Contours map to mark hazards or points of interest.

- 1 From the Navigation chart, select a location.
- 2 Select **Add Quickdraw Label**.
- 3 Enter text for the label, and select **Done**.

## Garmin Quickdraw Community

The Garmin Quickdraw Community is a free, public, online community that enables you to share your Garmin Quickdraw Contours maps with others. You can also download maps other users have created.

If your device has Wi-Fi technology, you can use the ActiveCaptain app to access the Garmin Quickdraw Community (*Connecting to the Garmin Quickdraw Community with ActiveCaptain*, page 12).

If your device does not have Wi-Fi technology, you can use the Garmin Connect™ website to access the Garmin Quickdraw Community (*Connecting to the Garmin Quickdraw Community with Garmin Connect*, page 12).

### Connecting to the Garmin Quickdraw Community with ActiveCaptain

- 1 From your mobile device, open the ActiveCaptain app and connect to the GPSMAP device (*Getting Started with the ActiveCaptain App*, page 4).

- 2 From the app, select **Quickdraw Community**.

You can download contours from others in the community (*Downloading Garmin Quickdraw Community Maps Using ActiveCaptain*, page 12) and share the contours you have created (*Sharing Your Garmin Quickdraw Contours Maps with the Garmin Quickdraw Community Using ActiveCaptain*, page 12).

### Downloading Garmin Quickdraw Community Maps Using ActiveCaptain

You can download Garmin Quickdraw Contours maps that other users have created and shared with the Garmin Quickdraw Community.

- 1 From the ActiveCaptain app on your mobile device, select **Quickdraw Community > Search for Contours**.
- 2 Use the map and search features to locate an area to download.
 

The red dots represent Garmin Quickdraw Contours maps that have been shared for that area.
- 3 Select **Select Download Region**.
- 4 Drag the box to select the area to download.
- 5 Drag the corners to change the download area.
- 6 Select **Download Area**.

The next time you connect the ActiveCaptain app to the GPSMAP device, the downloaded contours are transferred to the device automatically.

### Sharing Your Garmin Quickdraw Contours Maps with the Garmin Quickdraw Community Using ActiveCaptain

You can share Garmin Quickdraw Contours maps that you have created with others in the Garmin Quickdraw Community.

When you share a contour map, only the contour map is shared. Your waypoints are not shared.

When you set up your ActiveCaptain app, you may have selected to share your contours with the community automatically. If not, follow these steps to enable sharing.

From the ActiveCaptain app on your mobile device, select **Quickdraw Community**.

The next time you connect the ActiveCaptain app to the GPSMAP device, your contour maps are transferred to the community automatically.

### Connecting to the Garmin Quickdraw Community with Garmin Connect

- 1 Go to [connect.garmin.com](http://connect.garmin.com).
- 2 Select **Get Started > Quickdraw Community > Get Started**.
- 3 If you do not have a Garmin Connect account, create one.
- 4 Sign in to your Garmin Connect account.
- 5 Select **Marine** in the upper-right to open the Garmin Quickdraw widget.

**TIP:** Make sure you have a memory card in your computer to share Garmin Quickdraw Contours maps.

### Sharing Your Garmin Quickdraw Contours Maps with the Garmin Quickdraw Community Using Garmin Connect

You can share Garmin Quickdraw Contours maps that you have created with others in the Garmin Quickdraw Community.

When you share a contour map, only the contour map is shared. Your waypoints are not shared.

- 1 Remove the memory card from the chartplotter.
- 2 Insert the memory card into your computer.
- 3 Access the Garmin Quickdraw Community (*Connecting to the Garmin Quickdraw Community with Garmin Connect*, page 12).
- 4 Select **Share Your Contours**.
- 5 Browse to your memory card, and select the /Garmin folder.

- Open the Quickdraw folder, and select the file named ContoursLog.svy.

After the file is uploaded, delete the ContoursLog.svy file from your memory card to avoid issues with future uploads. Your data will not be lost.

### Downloading Garmin Quickdraw Community Maps Using Garmin Connect

You can download Garmin Quickdraw Contours maps that other users have created and shared with the Garmin Quickdraw Community.

If your device does not have Wi-Fi technology, you can access the Garmin Quickdraw Community using the Garmin Connect website.

If your device has Wi-Fi technology, you should access the Garmin Quickdraw Community using the ActiveCaptain app ([Connecting to the Garmin Quickdraw Community with ActiveCaptain](#), page 12).

- Insert the memory card into your computer.
- Access the Garmin Quickdraw Community ([Connecting to the Garmin Quickdraw Community with Garmin Connect](#), page 12).
- Select **Search for Contours**.
- Use the map and search features to locate an area to download.
 

The red dots represent Garmin Quickdraw Contours maps that have been shared for that region.
- Select **Select an Area to Download**.
- Drag the edges of the box to select the area to download.
- Select **Start Download**.
- Save the file to your memory card.
 

**TIP:** If you cannot find the file, look in the "Downloads" folder. The browser may have saved the file there.
- Remove the memory card from your computer.
- Insert the memory card into the chartplotter.

The chartplotter automatically recognizes the contours maps. The chartplotter may take a few minutes to load the maps.

### Garmin Quickdraw Contours Settings

From a chart, select **MENU > Quickdraw Contours > Settings**.

**Display:** Displays Garmin Quickdraw Contours. The User Contours option shows your own Garmin Quickdraw Contours maps. The Community Contours option shows the maps you have downloaded from the Garmin Quickdraw Community.

**Recording Offset:** Sets the distance between the sonar depth and the contour recording depth. If the water level has changed since your last recording, adjust this setting so the recording depth is the same for both recordings.

For example, if the last time you recorded had a sonar depth of 3.1 m (10.5 ft.), and today's sonar depth is 3.6 m (12 ft.), enter -0.5 m (-1.5 ft.) for the a Recording Offset value.

**User Display Offset:** Sets differences in contour depths and depth labels on your own contours maps to compensate for changes in the water level of a body of water, or for depth errors in recorded maps.

**Comm. Display Offset:** Sets differences in contour depths and depth labels on the community contours maps to compensate for changes in the water level of a body of water, or for depth errors in recorded maps.

**Survey Coloring:** Sets the color of the Garmin Quickdraw Contours display. When this setting is turned on, the colors indicate the quality of the recording. When this setting is turned off, the contour areas use standard map colors.

Green indicates good depth and GPS position, and a speed under 16 km/h (10 mph). Yellow indicates good depth and GPS position, and a speed between 16 and 32 km/h (10 and 20 mph). Red indicates poor depth or GPS position, and a speed above 32 km/h (20 mph).

**Depth Shading:** Specifies the minimum and maximum depths of a depth range and a color for that depth range.

### Depth Range Shading

You can set color ranges on your map to show the water depths where your target fish are currently biting. You can set deeper ranges to monitor how quickly the bottom depth changes within a specific depth range. You can create up to ten depth ranges. For inland fishing, a maximum of five depth ranges can help reduce map clutter.

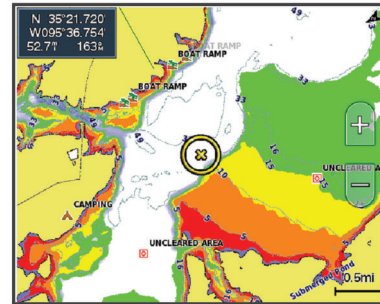

Red	From 0 to 1.5 m (from 0 to 5 ft.)
Orange	From 1.5 to 3 m (from 5 to 10 ft.)
Yellow	From 3 to 4.5 m (from 10 to 15 ft.)
Green	From 4.5 to 7.6 m (from 15 to 25 ft.)

## Navigation with a Chartplotter

### ⚠ CAUTION

If your vessel has an autopilot system, a dedicated autopilot control display must be installed at each steering helm in order to disable the autopilot system.

The Auto Guidance feature is based on electronic chart information. That data does not ensure obstacle and bottom clearance. Carefully compare the course to all visual sightings, and avoid any land, shallow water, or other obstacles that may be in your path.

When using Go To, a direct course and a corrected course may pass over land or shallow water. Use visual sightings, and steer to avoid land, shallow water, and other dangerous objects.

**NOTE:** Some chart views are available with premium charts, in some areas.

To navigate, you must choose a destination, set a course or create a route, and follow the course or route. You can follow the course or the route on the Navigation chart, Fishing chart, Perspective 3D chart view, or Mariner's Eye 3D chart view.

You can set and follow a course to a destination using one of three methods: Go To, Route To, or Auto Guidance.

**Go To:** Takes you directly to the destination. This is the standard option for navigating to a destination. The chartplotter creates a straight-line course or navigation line to the destination. The path may run over land and other obstacles.

**Route To:** Creates a route from your location to a destination, allowing you to add turns along the way. This option provides a straight-line course to the destination, but allows you to add turns into the route to avoid land and other obstacles.

**Auto Guidance:** Uses the specified information about your vessel and chart data to determine the best path to your destination. This option is available only when using a compatible premium chart in a compatible chartplotter. It

provides a turn-by-turn navigation path to the destination, avoiding land and other obstacles (*Auto Guidance*, page 16).

When you are using a compatible Garmin autopilot connected to the chartplotter using NMEA 2000®, the autopilot follows the Auto Guidance route.

**NOTE:** Auto Guidance is available with premium charts, in some areas.

## Basic Navigation Questions

Question	Answer
How do I make the chartplotter point me in the direction in which I want to go (bearing)?	Navigate using Go To ( <i>Setting and Following a Direct Course Using Go To</i> , page 15).
How do I make the device guide me along a straight line (minimizing cross track) to a location using the shortest distance from the present location?	Build a single-leg route and navigate it using Route To ( <i>Creating and Navigating a Route From Your Present Location</i> , page 15).
How do I make the device guide me to a location while avoiding charted obstacles?	Build a multi-leg route and navigate it using Route To ( <i>Creating and Navigating a Route From Your Present Location</i> , page 15).
How do I make the device steer my automatic pilot?	Navigate using Route To ( <i>Creating and Navigating a Route From Your Present Location</i> , page 15).
Can the device create a path for me?	If you have premium maps that support Auto Guidance and are in an area covered by Auto Guidance, navigate using Auto Guidance ( <i>Setting and Following an Auto Guidance Path</i> , page 16).
How do I change the Auto Guidance settings for my boat?	See <i>Auto Guidance Path Configurations</i> , page 16.

## Destinations

You can select destinations using various charts and 3D chart views or using the lists.

### Searching for a Destination by Name

You can search for saved waypoints, saved routes, saved tracks, and marine services destinations by name.

**1** Select **NAV INFO > Services > Search by Name**.

**2** Enter at least a portion of the name of your destination.

**3** If necessary, select **Done**.

The 50 nearest destinations that contain your search criteria appear.

**4** Select the destination.

### Selecting a Destination Using the Navigation Chart

From the Navigation chart, select a destination.

### Searching for a Marine Services Destination

**NOTE:** This feature is available with premium charts, in some areas.

The chartplotter contains information for thousands of destinations offering marine services.

**1** Select **NAV INFO > Services**.

**2** Select **Offshore Services** or **Inland Services**.

**3** If necessary, select the marine service category.

The chartplotter shows a list of the nearest locations and the distance and bearing to each.

**4** Select a destination.

You can select Next Page or Previous Page to view additional information or to show the location on a chart.

## Stopping Navigation

While navigating, from the Navigation or Fishing chart, select an option:

- Select **MENU > Stop Navigation**.
- When navigating with Auto Guidance, select **MENU > Navigation Options > Stop Navigation**.

## Waypoints

Waypoints are locations you record and store in the device. Waypoints can mark where you are, where you are going, or where you have been. You can add details about the location, such as name, elevation, and depth.

### Marking Your Present Location as a Waypoint

From any screen, select **MARK/SOS**.

### Creating a Waypoint at a Different Location

**1** Select **NAV INFO > User Data > Waypoints > New Waypoint**.

**2** Select an option:

- To create the waypoint by entering position coordinates, select **Enter Coordinates**, and enter the coordinates.
- To create the waypoint using a chart, select **Use Chart**, select the location, and select **SELECT**.

### Marking an SOS Location

You can mark an SOS or MOB (man overboard) location.

**1** Hold **MARK/SOS** for one second.

**2** Select the SOS type.

**3** If necessary, select **OK** to navigate to the man overboard location.

If you selected OK, the chartplotter sets a direct course back to the location. If you selected another type of SOS, the call details are sent to the VHF radio. You must send the call using the radio.

### Viewing a List of all Waypoints

Select **NAV INFO > User Data > Waypoints**.

### Editing a Saved Waypoint

**1** Select **NAV INFO > User Data > Waypoints**.

**2** Select a waypoint.

**3** Select **Review > Edit**.

**4** Select an option:

- To add a name, select **Name**, and enter a name.
- To change the symbol, select **Symbol**.
- To change the depth, select **Depth**.
- To change the water temperature, select **Water Temp..**
- To change the comment, select **Comment**.

### Moving a Saved Waypoint

**1** Select **NAV INFO > User Data > Waypoints**.

**2** Select a waypoint.

**3** Select **Review > Move**.

**4** Indicate a new location for the waypoint:

- To move the waypoint while using the chart, select **Use Chart**, select a new location on the chart, and select **Move Waypoint**.
- To move the waypoint using coordinates, select **Enter Coordinates**, and enter the new coordinates.

### Browsing for and Navigating to a Saved Waypoint

#### CAUTION

The Auto Guidance feature is based on electronic chart information. That data does not ensure obstacle and bottom clearance. Carefully compare the course to all visual sightings,

and avoid any land, shallow water, or other obstacles that may be in your path.

When using Go To, a direct course and a corrected course may pass over land or shallow water. Use visual sightings, and steer to avoid land, shallow water, and other dangerous objects.

**NOTE:** Auto Guidance is available with premium charts, in some areas.

Before you can navigate to a waypoint, you must create a waypoint.

- 1 Select **NAV INFO > User Data > Waypoints**.
- 2 Select a waypoint.
- 3 Select **Navigate To**.
- 4 Select an option:
  - To navigate directly to the location, select **Go To**.
  - To create a route to the location, including turns, select **Route To**.
  - To use Auto Guidance, select **Auto Guidance**.
- 5 Review the course indicated by the magenta line.

**NOTE:** When using Auto Guidance, a gray segment within any part of the magenta line indicates that Auto Guidance cannot calculate part of the Auto Guidance line. This is due to the settings for minimum safe water depth and minimum safe obstacle height.
- 6 Follow the magenta line, steering to avoid land, shallow water, and other obstacles.

### Deleting a Waypoint or an MOB

- 1 Select **NAV INFO > User Data > Waypoints**.
- 2 Select a waypoint or an MOB.
- 3 Select **Review > Delete**.

### Deleting All Waypoints

Select **NAV INFO > User Data > Clear User Data > Waypoints > All**.

### Setting and Following a Direct Course Using Go To

#### CAUTION

When using Go To, a direct course and a corrected course may pass over land or shallow water. Use visual sightings, and steer to avoid land, shallow water, and other dangerous objects.

You can set and follow a direct course from your current location to a selected destination.

- 1 Select a destination (*Destinations, page 14*).
- 2 Select **Navigate To > Go To**.

A magenta line appears. In the center of the magenta line is a thinner purple line that represents the corrected course from your current location to the destination. The corrected course is dynamic, and it moves with your boat when you are off course.
- 3 Follow the magenta line, steering to avoid land, shallow water, and other obstacles.
- 4 If you are off course, follow the purple line (corrected course) to go to your destination, or steer back to the magenta line (direct course).

## Routes

### Creating and Navigating a Route From Your Present Location

You can create and immediately navigate a route on the Navigation chart or the Fishing chart. This method does not save the route or the waypoint data.

- 1 From the Navigation chart or Fishing chart, select a destination.

- 2 Select **SELECT > Navigate To > Route To**.
- 3 Select the location of the last turn before the destination.
- 4 Select **SELECT > Add Turn**.
- 5 If necessary, repeat to add turns, working backward from the destination to the present location of your vessel.

The last turn you add should be the first turn you make, starting from your present location. It should be the turn closest to your vessel.
- 6 If necessary, select **MENU**.
- 7 Select **SELECT > Done**.
- 8 Review the course indicated by the magenta line.
- 9 Follow the magenta line, steering to avoid land, shallow water, and other obstacles.

### Creating and Saving a Route

This procedure saves the route and all the waypoints in it. The starting point can be your present location or another location.

You can add up to 250 waypoints, or turns, to one route.

- 1 Select **NAV INFO > User Data > Routes & Auto Guidance Paths > New > Route Using Chart**.
- 2 Select the starting location of the route.
- 3 Select **Add Turn**.
- 4 Select the location of the next turn on the chart.
- 5 Select **Add Turn**.

The chartplotter marks the location of the turn with a waypoint.
- 6 If necessary, repeat steps 4 and 5 to add more turns.
- 7 Select the final destination.

### Viewing a List of Routes and Auto Guidance Paths

- 1 Select **NAV INFO > User Data > Routes & Auto Guidance Paths**.
- 2 If necessary, select **Filter** to see routes only or Auto Guidance paths only.

### Editing a Saved Route

You can change the name of a route or change the turns the route contains.

- 1 Select **NAV INFO > User Data > Routes & Auto Guidance Paths**.
- 2 Select a route.
- 3 Select **Review > Edit Route**.
- 4 Select an option:
  - To change the name, select **Name**, and enter the name.
  - To select a waypoint from the turn list, select **Edit Turns > Use Turn List**, and select a waypoint from the list.
  - To select a turn using the chart, select **Edit Turns > Use Chart**, and select a location on the chart.

### Browsing for and Navigating a Saved Route

Before you can browse a list of routes and navigate to one of them, you must create and save at least one route.

- 1 Select **NAV INFO > User Data > Routes & Auto Guidance Paths**.
- 2 Select a route.
- 3 Select **Navigate To**.
- 4 Select an option:
  - To navigate the route from the starting point used when the route was created, select **Forward**.
  - To navigate the route from the destination point used when the route was created, select **Backward**.

A magenta line appears. In the center of the magenta line is a thinner purple line that represents the corrected course from your present location to the destination. The corrected course is dynamic, and it moves with your boat when you are off course.

- 5 Review the course indicated by the magenta line.
- 6 Follow the magenta line along each leg in the route, steering to avoid land, shallow water, and other obstacles.
- 7 If you are off course, follow the purple line (corrected course) to go to your destination, or steer back to the magenta line (direct course).

### Browsing for and Navigating Parallel to a Saved Route

Before you can browse a list of routes and navigate to one of them, you must create and save at least one route.

- 1 Select **NAV INFO > User Data > Routes & Auto Guidance Paths**.
- 2 Select a route.
- 3 Select **Navigate To**.
- 4 Select **Offset** to navigate parallel to the route, offset from it by a specific distance.
- 5 Indicate how to navigate the route:
  - To navigate the route from the starting point used when the route was created, to the left of the original route, select **Forward - Port**.
  - To navigate the route from the starting point used when the route was created, to the right of the original route, select **Forward - Starboard**.
  - To navigate the route from the destination point used when the route was created, to the left of the original route, select **Backward - Port**.
  - To navigate the route from the destination point used when the route was created, to the right of the original route, select **Backward - Starboard**.

- 6 If necessary, select **Done**.

A magenta line appears. In the center of the magenta line is a thinner purple line that represents the corrected course from your present location to the destination. The corrected course is dynamic, and it moves with your boat when you are off course.

- 7 Review the course indicated by the magenta line.
- 8 Follow the magenta line along each leg in the route, steering to avoid land, shallow water, and other obstacles.
- 9 If you are off course, follow the purple line (corrected course) to go to your destination, or steer back to the magenta line (direct course).

### Deleting a Saved Route

- 1 Select **NAV INFO > User Data > Routes & Auto Guidance Paths**.
- 2 Select a route.
- 3 Select **Review > Delete**.

### Deleting All Saved Routes

Select **NAV INFO > User Data > Clear User Data > Routes & Auto Guidance Paths**.

## Auto Guidance

### ⚠ CAUTION

The Auto Guidance feature is based on electronic chart information. That data does not ensure obstacle and bottom clearance. Carefully compare the course to all visual sightings, and avoid any land, shallow water, or other obstacles that may be in your path.

**NOTE:** Auto Guidance is available with premium charts, in some areas.

You can use Auto Guidance to plot the best path to your destination. Auto Guidance uses your chartplotter to scan chart data, such as water depth and known obstacles, to calculate a suggested path. You can adjust the path during navigation.

### Setting and Following an Auto Guidance Path

- 1 Select a destination (*Destinations*, page 14).
- 2 Select **Navigate To > Auto Guidance**.
- 3 Review the path, indicated by the magenta line.
- 4 Select **Start Navigation**.
- 5 Follow the magenta line, steering to avoid land, shallow water, and other obstacles.

**NOTE:** When using Auto Guidance, a gray segment within any part of the magenta line indicates that Auto Guidance cannot calculate part of the Auto Guidance line. This is due to the settings for minimum safe water depth and minimum safe obstacle height.

### Creating and Saving an Auto Guidance Path

- 1 Select **NAV INFO > User Data > Routes & Auto Guidance Paths > New > Auto Guidance**.
- 2 Select a starting point, and select **Next**.
- 3 Select a destination, and select **Next**.
- 4 Select an option:
  - To view a hazard and adjust the path near a hazard, select **Hazard Review**.
  - To adjust the path, select **Adjust Path**, and follow the on-screen instructions.
  - To delete the path, select **Cancel Auto Guidance**.
  - To save the path, select **Done**.

### Adjusting a Saved Auto Guidance Path

- 1 Select **NAV INFO > User Data > Routes & Auto Guidance Paths**.
- 2 Select a path, and select **Review > Edit > Adjust Path**.

**TIP:** When navigating an Auto Guidance path, select the path on the navigation chart, and select **Adjust Path**.
- 3 Select a location on the path.
- 4 Drag the point to a new location.
- 5 If necessary, select a point, and select **Remove**.
- 6 Select **Done**.

### Canceling an Auto Guidance Calculation in Progress

From the Navigation chart, select **MENU > Cancel**.

**TIP:** You can select **BACK** to quickly cancel the calculation.

### Setting a Timed Arrival

You can use this feature on a route or an Auto Guidance path to get feedback about when you should arrive at a selected point. This allows you to time your arrival at a location, such as a bridge opening or a race starting line.

- 1 From the Navigation chart, select **MENU**.
- 2 If necessary, select **Navigation Options**.
- 3 Select **Timed Arrival**.

**TIP:** You can quickly open the Timed Arrival menu by selecting a point on the path or route.

### Auto Guidance Path Configurations

### ⚠ CAUTION

The Preferred Depth and Vertical Clearance settings influence how the chartplotter calculates an Auto Guidance path. If an area has an unknown water depth or an unknown obstacle height, the Auto Guidance path is not calculated in that area. If



an area at the beginning or the end of an Auto Guidance path is shallower than the Preferred Depth or lower than the Vertical Clearance settings, the Auto Guidance path may not be calculated in that area, depending on the map data. On the chart, the course through those areas appears as a gray line or a magenta and gray striped line. When your boat enters one of those areas, a warning message appears.

**NOTE:** Auto Guidance is available with premium charts, in some areas.

**NOTE:** Not all settings apply to all maps.

You can set the parameters the chartplotter uses when calculating an Auto Guidance path.

**Preferred Depth:** Sets the minimum water depth, based on chart depth data, that your boat can safely travel over.

**NOTE:** The minimum water depth for the premium charts (made before 2016) is 3 feet. If you enter a value of less than 3 feet, the charts only use depths of 3 feet for Auto Guidance path calculations.

**Vertical Clearance:** Sets the minimum height of a bridge or obstacle, based on chart data, that your boat can safely travel under.

**Shoreline Distance:** Sets how close to the shore you want the Auto Guidance path to be placed. The Auto Guidance path may move if you change this setting while navigating. The available values for this setting are relative, not absolute. To ensure that the Auto Guidance line is placed the appropriate distance from shore, you can assess the placement of the Auto Guidance path using one or more familiar destinations that require navigation through a narrow waterway ([Adjusting the Distance from Shore, page 17](#)).

### Adjusting the Distance from Shore

The Shoreline Distance setting indicates how close to the shore you want the Auto Guidance line to be placed. The Auto Guidance line may move if you change this setting while navigating. The available values for the Shoreline Distance setting are relative, not absolute. To ensure the Auto Guidance line is placed the appropriate distance from shore, you can assess the placement of the Auto Guidance line using one or more familiar destinations that require navigation through a narrow waterway.

- 1 Dock your vessel or drop the anchor.
- 2 Select **Settings > Preferences > Navigation > Auto Guidance > Shoreline Distance > Normal**.
- 3 Select a destination that you have navigated to previously.
- 4 Select **Navigate To > Auto Guidance**.
- 5 Review the placement of the Auto Guidance line, and determine whether the line safely avoids known obstacles and the turns enable efficient travel.
- 6 Select an option:
  - If the placement of the Auto Guidance line is satisfactory, select **MENU > Navigation Options > Stop Navigation**, and proceed to step 10.
  - If the Auto Guidance line is too close to known obstacles, select **Settings > Preferences > Navigation > Auto Guidance > Shoreline Distance > Far**.
  - If the turns in the Auto Guidance line are too wide, select **Settings > Preferences > Navigation > Auto Guidance > Shoreline Distance > Near**.
- 7 If you selected **Near** or **Far** in step 6, review the placement of the Auto Guidance line, and determine whether the line safely avoids known obstacles and the turns enable efficient travel.

Auto Guidance maintains a wide clearance from obstacles in open water, even if you set the Shoreline Distance setting to Near or Nearest. As a result, the chartplotter may not

reposition the Auto Guidance line, unless the destination selected requires navigation through a narrow waterway.

- 8 Select an option:
  - If the placement of the Auto Guidance line is satisfactory, select **MENU > Navigation Options > Stop Navigation**, and proceed to step 10.
  - If the Auto Guidance line is too close to known obstacles, select **Settings > Preferences > Navigation > Auto Guidance > Shoreline Distance > Farthest**.
  - If the turns in the Auto Guidance line are too wide, select **Settings > Preferences > Navigation > Auto Guidance > Shoreline Distance > Nearest**.
- 9 If you selected **Nearest** or **Farthest** in step 8, review the placement of the **Auto Guidance** line, and determine whether the line safely avoids known obstacles and the turns enable efficient travel.

Auto Guidance maintains a wide clearance from obstacles in open water, even if you set the Shoreline Distance setting to Near or Nearest. As a result, the chartplotter may not reposition the Auto Guidance line, unless the destination selected requires navigation through a narrow waterway.
- 10 Repeat steps 3 through 9 at least once more, using a different destination each time, until you are familiar with the functionality of the Shoreline Distance setting.

## Tracks

A track is a recording of the path of your boat. The track currently being recorded is called the active track, and it can be saved. You can show tracks in each chart or 3D chart view.

### Showing Tracks

From any chart or a 3D chart view, select **MENU > Waypoints and Tracks > Tracks > On**.

A trailing line on the chart indicates your track.

### Setting the Color of the Active Track

- 1 Select **NAV INFO > User Data > Tracks > Active Track Options > Track Color**.
- 2 Select a track color.

### Saving the Active Track

The track currently being recorded is called the active track.

- 1 Select **NAV INFO > User Data > Tracks > Save Active Track**.
- 2 Select an option:
  - Select the time the active track began.
  - Select **Entire Log**.
- 3 Select **Save**.

### Viewing a List of Saved Tracks

Select **NAV INFO > User Data > Tracks > Saved Tracks**.

### Editing a Saved Track

- 1 Select **NAV INFO > User Data > Tracks > Saved Tracks**.
- 2 Select a track.
- 3 Select **Edit Track**.
- 4 Select an option:
  - Select **Name**, and enter the new name.
  - Select **Track Color**, and select a color.

### Saving a Track as a Route

- 1 Select **NAV INFO > User Data > Tracks > Saved Tracks**.
- 2 Select a track.
- 3 Select **SELECT > Edit Track > Save Route**.

## Browsing for and Navigating a Recorded Track

Before you can browse a list of tracks and navigate to them, you must record and save at least one track ([Tracks, page 17](#)).

- 1 Select **NAV INFO > User Data > Tracks > Saved Tracks**.
- 2 Select a track.
- 3 Select **Follow Track**.
- 4 Select an option:
  - To navigate the track from the starting point used when the track was created, select **Forward**.
  - To navigate the track from the destination point used when the track was created, select **Backward**.
- 5 Review the course indicated by the colored line.
- 6 Follow the line along each leg in the route, steering to avoid land, shallow water, and other obstacles.

## Deleting a Saved Track

- 1 Select **NAV INFO > User Data > Tracks > Saved Tracks**.
- 2 Select a track.
- 3 Select **SELECT > Delete**.

## Deleting All Saved Tracks

Select **NAV INFO > User Data > Clear User Data > Saved Tracks**.

## Retracing the Active Track

The track currently being recorded is called the active track.

- 1 Select **NAV INFO > User Data > Tracks > Follow Active Track**.
- 2 Select an option:
  - Select the time the active track began.
  - Select **Entire Log**.
- 3 Review the course indicated by the colored line.
- 4 Follow the colored line, steering to avoid land, shallow water, and other obstacles.

## Clearing the Active Track

Select **NAV INFO > User Data > Tracks > Clear Active Track**.

The track memory is cleared, and the active track continues to be recorded.

## Managing the Track Log Memory During Recording

- 1 Select **NAV INFO > User Data > Tracks > Active Track Options**.
- 2 Select **Record Mode**.
- 3 Select an option:
  - To record a track log until the track memory is full, select **Fill**.
  - To continuously record a track log, replacing the oldest track data with new data, select **Wrap**.

## Configuring the Recording Interval of the Track Log

You can indicate the frequency at which the track plot is recorded. Recording more frequent plots is more accurate but fills the track log faster. The resolution interval is recommended for the most efficient use of memory.

- 1 Select **NAV INFO > User Data > Tracks > Active Track Options > Interval > Interval**.
- 2 Select an option:
  - To record the track based on a distance between points, select **Distance > Change**, and enter the distance.
  - To record the track based on a time interval, select **Time > Change**, and enter the time interval.
  - To record the track plot based on a variance from your course, select **Resolution > Change**, and enter the

maximum error allowed from the true course before recording a track point. This is the recommended recording option.

## Boundaries

Boundaries allow you to avoid or remain in designated areas in a body of water. You can set an alarm to alert you when you enter or exit a boundary.

You can create boundary areas, lines, and circles using the map. You can also convert saved tracks and routes into boundary lines. You can create a boundary area using waypoints by creating a route from the waypoints, and converting the route into a boundary line.

You can select a boundary to act as the active boundary. You can add the active boundary data to the data fields on the chart.

## Creating a Boundary

- 1 Select **NAV INFO > User Data > Boundaries > New Boundary**.
- 2 Select a boundary shape.
- 3 Follow the on-screen instructions.

## Converting a Route to a Boundary

Before you can convert a route to a boundary, you must create and save at least one route ([Creating and Saving a Route, page 15](#)).

- 1 Select **NAV INFO > User Data > Routes & Auto Guidance Paths**.
- 2 Select a route.
- 3 Select **Review > Edit Route > Save as Boundary**.

## Converting a Track to a Boundary

Before you can convert a track to a boundary, you must record and save at least one track ([Saving the Active Track, page 17](#)).

- 1 Select **NAV INFO > User Data > Tracks > Saved Tracks**.
- 2 Select a track.
- 3 Select **SELECT > Edit Track > Save as Boundary**.

## Editing a Boundary

- 1 Select **NAV INFO > User Data > Boundaries**.
- 2 Select a boundary.
- 3 Select **Review > Edit Boundary**.
- 4 Select an option:
  - To edit the appearance of the boundary on the chart, select **Display Options**.
  - To change the boundary lines or name, select **Edit Boundary**.
  - To edit the boundary alarm, select **Alarm**.

## Linking a Boundary to a SmartMode Layout

You can link a boundary to a SmartMode layout to automatically open the layout when entering or exiting the boundary. For example, you can set a boundary around your marina, and automatically open the Docking layout when you approach the marina.

- 1 Select **NAV INFO > User Data > Boundaries**.
- 2 Select a boundary.
- 3 Select **Review > Link SmartMode™ > SmartMode™**.
- 4 Select **Entering**, and select a layout.
- 5 Select **Exiting**, and select a layout.

## Setting a Boundary Alarm

Boundary alarms alert you when you are within a specified distance of a set boundary.

- 1 Select **NAV INFO > User Data > Boundaries**.

- 2 Select a boundary.
- 3 Select **Alarm > On**.
- 4 Enter a distance.

### Deleting a Boundary

- 1 Select **NAV INFO > User Data > Boundaries**.
- 2 Select a boundary.
- 3 Select **Review > Edit Boundary > Delete**.

## Synchronizing User Data Across the Garmin Marine Network

### NOTICE

Before you synchronize the user data across the network, you should backup your user data to prevent possible data loss. See [Backing Up Data to a Computer, page 51](#).

You can share waypoints, tracks, and routes with all compatible devices connected to the Garmin Marine Network (Ethernet) automatically.

**NOTE:** This feature is not available on all models.

Select **Settings > Preferences > User Data Sharing > On**.

If a change is made to a waypoint, track, or route on one chartplotter, that data is synchronized automatically across all chartplotters on the Ethernet network.

## Deleting All Saved Waypoints, Routes, and Tracks

Select **NAV INFO > User Data > Clear User Data > All > OK**.

## Sailing Features

### Setting the Vessel Type

You can select your boat type to configure the chartplotter settings and to use features customized for your boat type.

- 1 Select **Settings > My Vessel > Vessel Type**.
- 2 Select an option.

### Sail Racing

You can use the device to increase the likelihood that your boat will cross the start line of a race exactly when the race begins. When you synchronize the race timer with the official race countdown timer, you are alerted at one-minute intervals as the race start approaches. When you combine the race timer with the virtual start line, the device measures your speed, bearing, and remaining time on the countdown timer. The device uses this data to indicate whether your boat will cross the start line before, after, or at the correct time to start the race.

### Starting Line Guidance

Sailing start line guidance is a visual representation of the information you need to cross the start line at the optimal time and speed.

After you set the starboard and port start line pins, and the target speed and time, and after you start the race timer, a predictor line appears. The predictor line extends from your current location toward the start line and the laylines that extend from each pin.

The end point and color of the predictor line indicate where the boat will be when the timer expires, based on your current boat speed.

When the end point is before the start line, the line is white. This indicates the boat must increase speed to reach the start line on time.

When the end point is past the start line, the line is red. This indicates the boat must reduce speed to avoid a penalty for reaching the start line before the timer expires.

When the end point is on the start line, the line is white. This indicates the boat is moving at an optimal speed to reach the start line when the timer expires.

By default, the start line guidance window and the race timer window appear in the Sail Racing combination screen.

### Setting the Starting Line

The start line guidance window is added to the Sail Racing combination screen by default.

- 1 From the Sail Racing combination screen, select **MENU > Start Line Guidance > Start Line**.
- 2 Select an option:
  - To mark the port and starboard starting line marks as you sail past them, select **Ping Marks**.
  - To mark the port and starboard starting line marks by entering their coordinates, select **Enter Coordinates**.
  - To switch the position of the port and starboard marks after you have set them, select **Swap Port & Starbd. Marks**.

### Using the Starting Line Guidance

You can use the starting line guidance feature to help get you cross the start line, at the optimal speed during a sailing race.

- 1 Mark the starting line ([Setting the Starting Line, page 19](#)).
- 2 From the Sail Racing combination screen, select **MENU > Start Line Guidance > Target Speed**, and select your target speed when crossing the starting line.
- 3 Select **Target Time**, and select the target time to cross the starting line.
- 4 Select **BACK**.
- 5 Start the racing timer ([Starting the Race Timer, page 19](#)).

### Starting the Race Timer

The race timer is added to the Sail Racing combination screen by default.

- 1 From the Sail Racing combination screen, select **Start**.
 

**NOTE:** You can also access this from the Sailing SmartMode screen and the navigation chart.
- 2 When necessary, select **Sync** to synchronize with the official race timer.

### Stopping the Race Timer

From the Sail Racing combination screen, select **Stop**.

### Setting the Distance between the Bow and the GPS Antenna

You can enter the distance between the bow of your boat and the location of your GPS antenna. This helps ensure the bow of your boat crosses the starting line at the precise start time.

- 1 From a navigation chart, select **MENU > Sailing > Start Line > GPS Bow Offset**.
- 2 Enter the distance.
- 3 Select **Done**.

### Laylines Settings

To use the laylines features, you must connect a wind sensor to the chartplotter.

When in sailing mode [Setting the Vessel Type, page 3](#), you can display laylines on the navigation chart. Laylines can be very helpful when racing.

From the navigation chart, select **MENU > Layers > My Vessel > Laylines > Setup**.

**Display:** Sets how the laylines and vessel appear on the chart, and sets the length of the laylines.

**Sailing Ang.:** Allows you to select how the device calculates laylines. The Actual option calculates the laylines using the measured wind angle from the wind sensor. The Manual option calculates the laylines using manually entered windward and leeward angles.

**Windward Ang.:** Allows you to set a layline based on the windward sailing angle.

**Leeward Ang.:** Allows you to set a layline based on the leeward sailing angle.

**Tide Correction:** Corrects the laylines based on the tide.

**Layline Filter:** Filters the layline data based on the time interval entered. For a smoother layline that filters out some of the changes in the boat's heading or true wind angle, enter a higher number. For laylines that display a higher sensitivity to changes in the boat's heading or true wind angle, enter a lower number.

## Setting the Keel Offset

You can enter a keel offset to compensate the water depth reading for the transducer installation location. This allows you to view the depth of the water below the keel or the true depth of the water, depending on your needs.

If you want to know the water depth below the keel or the lowest point of your boat and the transducer is installed at the water line or anywhere above the end of the keel, measure the distance from the transducer location to the keel of the boat.

If you want to know the true water depth and the transducer is installed below the water line, measure the distance from the bottom of the transducer up to the water line.

**NOTE:** This option is only available when you have valid depth data.

1 Measure the distance:

- If the transducer is installed at the water line ① or anywhere above the end of the keel, measure the distance from the transducer location to the keel of the boat. Enter this value as a positive number.
- If the transducer is installed at the bottom of the keel ② and you want to know the true depth of the water, measure the distance from the transducer to the water line. Enter this value in as a negative number.

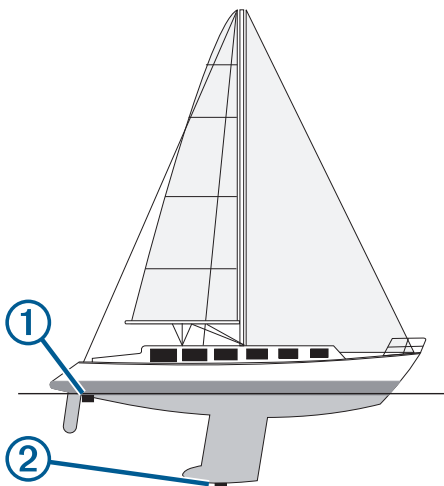

2 Select **Settings > My Vessel > Depth and Anchoring > Keel Offset**.

3 Select **+** if the transducer is installed at the water line, or select **-** if the transducer is installed at the bottom of the keel.

4 Use the arrow keys to enter the keel offset measured in step 1.

## Sailboat Autopilot Operation

### ⚠ CAUTION

When engaged, the autopilot controls only the rudder. You and your crew remain responsible for the sails while the autopilot is engaged.

In addition to heading hold, you can use the autopilot to maintain a wind hold. You can also use the autopilot to control the rudder while tacking and gybing.

### Wind Hold

You can set the autopilot to maintain a specific bearing relative to the current wind angle. Your device must be connected to a NMEA 2000 or NMEA<sup>®</sup> 0183 compatible wind sensor to perform a wind hold or a wind-based tack or gybe.

#### Setting the Wind Hold Type

Before you can enable the wind hold type, you must connect a NMEA 2000 or NMEA 0183 wind sensor to the autopilot.

For advanced autopilot configuration, see the installation instructions included with your autopilot.

- 1 From the autopilot screen, select **MENU > Autopilot Setup > Wind Hold Type**.
- 2 Select **Apparent** or **True**.

#### Engaging Wind Hold

Before you can enable the wind hold type, you must connect a NMEA 2000 or NMEA 0183 wind sensor to the autopilot.

When the autopilot is in standby mode, select **Wind Hold**.

#### Engaging Wind Hold from Heading Hold

Before you can enable the wind hold type, you must connect a NMEA 2000 or NMEA 0183 wind sensor to the autopilot.

With heading hold engaged, select **MENU > Wind Hold**.

#### Adjusting the Wind Hold Angle with the Autopilot

You can adjust the wind hold angle on the autopilot when wind hold is engaged.

- To adjust the wind hold angle in increments of 1°, select ◀ or ▶.
- To adjust the wind hold angle in increments of 10°, hold ◀ or ▶.

### Tack and Gybe

You can set the autopilot to perform a tack or gybe while heading hold or wind hold is engaged.

#### Tacking and Gybing from Heading Hold

- 1 Engage heading hold ([Engaging the Autopilot](#), page 34).
- 2 Select **MENU**.
- 3 Select an option.

The autopilot steers your boat through a tack or gybe.

#### Tacking and Gybing from Wind Hold

Before you can engage wind hold, you must have a wind sensor installed.

- 1 Engage wind hold ([Engaging Wind Hold](#), page 20).
- 2 Select **MENU**.
- 3 Select an option.

The autopilot steers your boat through a tack or gybe, and information about the progress of the tack or gybe appears on the screen.

#### Setting a Tack and Gybe Delay

The tack and gybe delay allows you to delay steering a tack and gybe after you initiate the maneuver.

- 1 From the autopilot screen, select **MENU > Autopilot Setup > Sailing Setup > Tack Delay**.
- 2 Select the length of the delay.
- 3 If necessary, select **Done**.

### Enabling the Gybe Inhibitor

**NOTE:** The gybe inhibitor does not prevent you from manually performing a gybe using the helm or step steering.

The gybe inhibitor prevents the autopilot from performing a gybe.

- 1 From the autopilot screen, select **MENU > Autopilot Setup > Sailing Setup > Gybe Inhibitor**.
- 2 Select **Enabled**.

## Heading Line and Angle Markers

The heading line is an extension drawn on the map from the bow of the boat in the direction of travel. Angle markers indicate relative position from the heading or course over ground, which are helpful for casting or finding reference points.

### Setting the Heading Line and Angle Markers

The heading line is an extension drawn on the map from the bow of the boat in the direction of travel. Angle markers indicate relative position from the heading or course over ground, which are helpful for casting or finding reference points.

You can show the heading line and the course over ground (COG) line on the chart.

COG is your direction of movement. Heading is the direction the bow of the boat is pointed, when a heading sensor is connected.

- 1 From a chart, select **MENU > Layers > My Vessel > Heading Line**.
- 2 Angle Markers
- 3 If necessary, select **Source**, and select an option:
  - To automatically use the available source, select **Auto**.
  - To use the GPS antenna heading for COG, select **GPS Heading (COG)**.
  - To use data from a connected heading sensor, select **North Reference**.
  - To use data from both a connected heading sensor and the GPS antenna, select **COG and Heading**.  
This displays both the heading line and the COG line on the chart.
- 4 Select **Display**, and select an option:
  - Select **Distance > Distance**, and enter the length of the line shown on the chart.
  - Select **Time > Time**, and enter the time used to calculate the distance your boat will travel in the specified time at your present speed.

## Sonar Fishfinder

When properly connected to a compatible transducer, your chartplotter can be used as a fishfinder.

For more information about which transducer is best for your needs, go to [www.garmin.com/transducers](http://www.garmin.com/transducers).

Different sonar views can help you view the fish in the area. The sonar views available vary depending on the type of transducer and sounder module connected to the chartplotter. For example, you can view certain Panoptix™ sonar screens only if you have a compatible Panoptix transducer connected.

There are four basic styles of sonar views available: a full-screen view, a split-screen view that combines two or more views, a split-zoom view, and a split-frequency view that displays two different frequencies. You can customize the settings for each view in the screen. For example, if you are

viewing the split-frequency view, you can separately adjust the gain for each frequency.

If you do not see an arrangement of sonar views to suit your needs, you can create a custom combination screen (*Creating a New Combination Page*, page 3) or a SmartMode layout (*Adding a SmartMode Layout*, page 2).

## Stopping the Transmission of Sonar Signals

From a sonar screen, select **MENU > Transmit**.

## Changing the Sonar View

- 1 From a combination screen or SmartMode layout with sonar, select the window to change.
- 2 Select **MENU > Change Sonar**.
- 3 Select a sonar view.

## Traditional Sonar View

There are several full-screen views available, depending on the equipment connected.

The full-screen Traditional sonar view show a large image of the sonar readings from a transducer. The range scale along the right side of the screen shows the depth of detected objects as the screen scrolls from the right to the left.

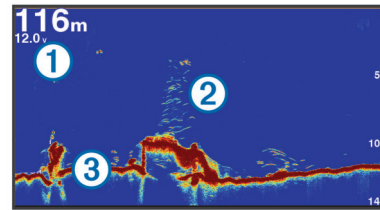

①	Depth information
②	Suspended targets or fish
③	Bottom of the body of water

## Split-Frequency Sonar View

In the split-frequency sonar view, one side of the screen shows a full-view graph of high frequency sonar data, and the other side of the screen shows a full-view graph of lower frequency sonar data.

**NOTE:** The split-frequency sonar view requires the use of a dual-frequency transducer.

## Split-Zoom Sonar View

The split-zoom sonar view shows a full-view graph of sonar readings, and a magnified portion of that graph, on the same screen.

## Garmin ClearVü Sonar View

**NOTE:** To receive Garmin ClearVü scanning sonar, you need a compatible chartplotter or fishfinder and a compatible transducer. For information about compatible transducers, go to [www.garmin.com/transducers](http://www.garmin.com/transducers).

Garmin ClearVü high-frequency sonar provides a detailed picture of the fishing environment around the boat in a detailed representation of structures the boat is passing over.

Traditional transducers emit a conical beam. The Garmin ClearVü scanning sonar technology emits two narrow beams, similar to the shape of the beam in a copying machine. These beams provide a clearer, picture-like image of what is beneath the boat.

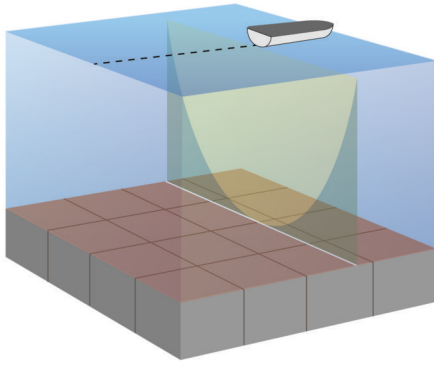

## SideVü Sonar View

**NOTE:** Not all models provide built-in SideVü sonar support. If your model does not provide built-in SideVü sonar, you need a compatible sounder module and compatible SideVü transducer. If your model does provide built-in SideVü sonar, you need a compatible SideVü transducer.

SideVü scanning sonar technology shows you a picture of what lies to the sides of the boat. You can use this as a search tool to find structures and fish.

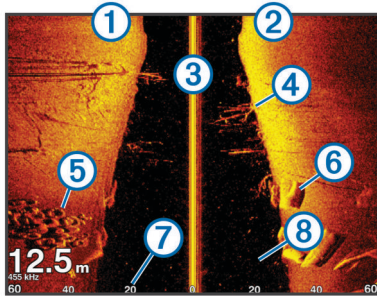

①	Left side of the boat
②	Right side of the boat
③	The transducer on your vessel
④	Trees
⑤	Old tires
⑥	Logs
⑦	Distance from the side of the boat
⑧	Water between the vessel and the bottom

## SideVü Scanning Technology

Instead of a more common conical beam, the SideVü transducer uses a flat beam to scan the water and bottom to the sides of your boat.

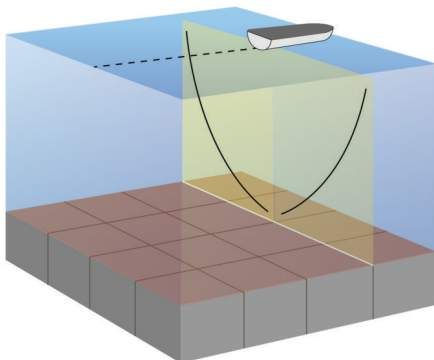

## Measuring Distance on the Sonar Screen

You can measure the distance between two points on the SideVü sonar view.

- 1 From the SideVü sonar view, select a location on the screen.
- 2 Select **Measure**.  
A push pin appears on the screen at the selected location.
- 3 Select another location.  
The distance and angle from the pin is listed in the upper-left corner.

**TIP:** To reset the pin and measure from the current location of the pin, select Measure.

## Panoptix Sonar Views

**NOTE:** Not all models support Panoptix transducers.

To receive Panoptix sonar, you need a compatible chartplotter and a compatible transducer.

The Panoptix sonar views allow you to see all around the boat in real time. You can also watch your bait underwater and bait schools in front of or below your boat.

The LiveVü sonar views provide you a view of the live movement either in front of or below your boat. The screen updates very quickly, producing sonar views that look more like live video.

The RealVü 3D sonar views provide three-dimensional views of either what is in front of or below your boat. The screen updates with each sweep of the transducer.

To see all five Panoptix sonar views, you need one transducer to show the down views and a second transducer to show the forward views.

To access the Panoptix sonar views, select Sonar, and select a view.

## LiveVü Down Sonar View

This sonar view shows a two-dimensional view of what is below the boat and can be used to see a bait ball and fish.

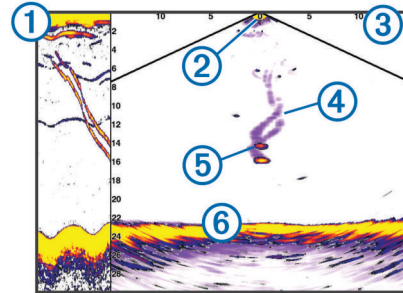

①	Panoptix down view history in a scrolling sonar view
②	Boat
③	Range
④	Trails
⑤	Drop shot rig
⑥	Bottom

## LiveVü Forward Sonar View

This sonar view shows a two-dimensional view of what is in front of the boat and can be used to see a bait ball and fish.

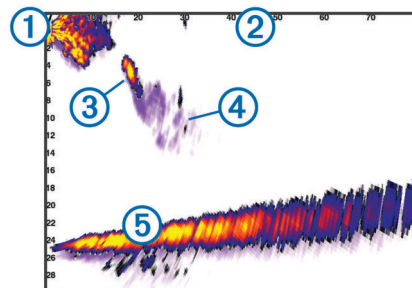

①	Boat
②	Range
③	Fish
④	Trails
⑤	Bottom

### RealVü 3D Forward Sonar View

This sonar view shows a three-dimensional view of what is in front of the transducer. This view can be used when you are stationary and you need to see the bottom and the fish approaching the boat.

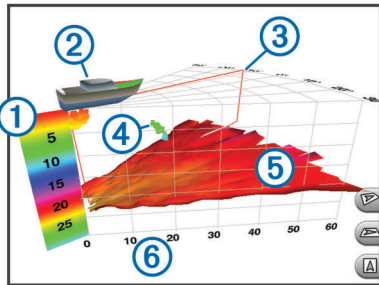

①	Color legend
②	Boat
③	Ping indicator
④	Fish
⑤	Bottom
⑥	Range

### RealVü 3D Down Sonar View

This sonar view shows a three-dimensional view of what is below the transducer and can be used when you are stationary and want to see what is around your boat.

### RealVü 3D Historical Sonar View

This sonar view provides a three-dimensional view of what is behind your boat as you are moving and shows the entire water column in 3D, from the bottom to the top of the water. This view is used for finding fish.

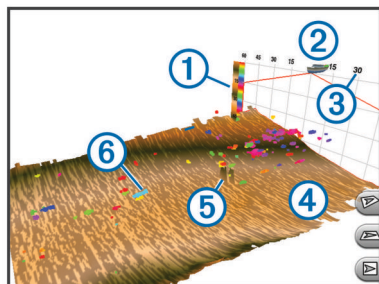

①	Color legend
②	Boat
③	Range
④	Bottom
⑤	Structure
⑥	Fish

### FrontVü Sonar View

The Panoptix FrontVü sonar view increases your situational awareness by showing obstructions under the water, up to 91 meters (300 feet) in front of the boat.

The ability to effectively avoid forward collisions with FrontVü sonar decreases as your speed rises above 8 knots.

To see the FrontVü sonar view, you must install and connect a compatible transducer, such as a PS21 transducer. You may need to update the transducer software.

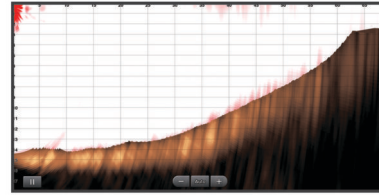

### Selecting the Transducer Type

Before you can select the transducer type, you must know what kind of transducer you have.

This chartplotter is compatible with a range of accessory transducers, including the Garmin ClearVü™ transducers, which are available at [www.garmin.com/transducers](http://www.garmin.com/transducers).

If you are connecting a transducer that was not included with the chartplotter, you may need to set the transducer type to make the sonar function properly. If the device automatically detects your transducer, this option does not appear.

- From a sonar view, select **MENU > Sonar Setup > Installation > Transducer Type**.
- Select an option:
  - If you have a 200/77 kHz, dual-beam transducer, select **Dual Beam (200/77 kHz)**.
  - If you have a 200/50 kHz, dual-frequency transducer, select **Dual Frequency (200/50 kHz)**.
  - If you have another type of transducer, select it from the list.

### Calibrating the Compass

Before you can calibrate the compass, the transducer must be installed on the shaft far enough away from the trolling motor to avoid magnetic interference, and deployed in the water. Calibration must be of sufficient quality to enable the internal compass.

**NOTE:** To use the compass, you must mount the transducer on the shaft. The compass does not work when you mount the transducer on the motor.

**NOTE:** Compass calibration is available only for transducers with an internal compass, such as the PS21-TR transducer.

You can begin turning your boat before calibrating, but you must fully rotate your boat 1.5 times during calibration.

- From an applicable sonar view, select **MENU > Sonar Setup > Installation**.
- If necessary, select **Use AHRS** to turn on the AHRS sensor.
- Select **Calibrate Compass**.
- Follow the on-screen instructions.

### Creating a Waypoint on the Sonar Screen

- From a sonar view, drag the screen or select **III**.
- Select a location.
- Select **New Wpt** or **♥+**.
- If necessary, edit the waypoint information.

### Pausing the Sonar Display

From a sonar view, select **III**.

### Viewing Sonar History

You can scroll the sonar display to view historical sonar data.

**NOTE:** Not all transducers save historical sonar data.

- From a sonar view, hold **⏪** to scroll through the history.

- 2 Select **BACK** to exit history.

## Sonar Sharing

This feature may not be available on all chartplotter models.

You can view the sonar data from all compatible sources on the Garmin Marine Network. You can view sonar data from a compatible external sonar module, such as a GCV™ sonar module. In addition, you can view the sonar data from other chartplotters that have a built-in sonar module.

Each chartplotter on the network can display sonar data from every compatible sonar module and transducer on the network, no matter where the chartplotters and transducers are mounted on your boat. For example, from a transducer with Garmin ClearVü mounted at the back of the boat, you can view the sonar data using the 922 mounted at the front of your boat.

When sharing sonar data, the values of some sonar settings, such as Range and Gain, are synchronized across the devices on the network. The values of other sonar settings, such as the Appearance settings, are not synchronized and should be configured on each individual device. In addition, the scroll rates of the various traditional and Garmin ClearVü sonar views are synchronized to make the split views more cohesive.

**NOTE:** Using multiple transducers simultaneously can create cross talk, which can be removed by adjusting the Interference sonar setting.

### Selecting a Sonar Source

This feature may not be available with all models.

When you are using more than one sonar data source for a particular sonar view, you can select the source to use for that sonar view. For example, if you have two sources for Garmin ClearVü, you can select the source to use from the Garmin ClearVü sonar view.

- 1 Open the sonar view for which you will change the source.
- 2 Select **MENU > Sonar Setup > Source**.
- 3 Select the source for this sonar view.

### Renaming a Sonar Source

You can rename a sonar source to easily identify that source. For example, you use "Bow" as the name of the transducer on the bow of your boat.

The source is renamed for the present view only. For example, to rename the Garmin ClearVü sonar source, you must open the Garmin ClearVü sonar view.

- 1 From the sonar view, select **MENU > Sonar Setup > Source > Rename Sources**.
- 2 Enter the name.

## Adjusting the Level of Detail

You can control the level of detail and noise shown on the sonar screen either by adjusting the gain for traditional transducers or by adjusting the brightness for Garmin ClearVü transducers.

If you want to see the highest intensity signal returns on the screen, you can lower the gain or brightness to remove lower intensity returns and noise. If you want to see all return information, you can increase the gain or brightness to see more information on the screen. This also increases noise, and can make it more difficult to recognize actual returns.

- 1 From a sonar view, select **MENU**.
- 2 Select **Gain** or **Brightness**.
- 3 Select an option:
  - To increase or decrease the gain or brightness manually, select **Up** or **Down**.
  - To allow the chartplotter to adjust the gain or brightness automatically, select an automatic option.

## Adjusting the Range, Gain, and Brightness With the Knob

On the Traditional sonar views, you can adjust the gain and range using the knob. On the ClearVü and SideVü sonar views, you can adjust the brightness and range using the knob.

- 1 From the sonar view, press the knob to switch between **Range** and **Gain** or **Brightness**.

The visual representation of the knob on the screen indicates the setting you are adjusting and the current level.
- 2 Turn the knob to adjust the range, gain, or brightness.
- 3 Press and hold the knob to return to **Auto** mode.

## Adjusting the Color Intensity

You can adjust the intensity of colors and highlight areas of interest on the sonar screen by adjusting the color gain for traditional transducers or the contrast for Garmin ClearVü and SideVü/ClearVü transducers. This setting works best after you have adjusted the level of detail shown on the screen using the gain or brightness settings.

If you want to highlight smaller fish targets or create a higher intensity display of a target, you can increase the color gain or contrast setting. This causes a loss in the differentiation of the high intensity returns at the bottom. If you want to reduce the intensity of the return, you can reduce the color gain or contrast.

- 1 From a sonar view, select **MENU**.
- 2 Select an option:
  - While in the Garmin ClearVü or SideVü sonar view, select **Contrast**.
  - While in a Panoptix LiveVü sonar view, select **Color Gain**.
  - While in another sonar view, select **Sonar Setup > Advanced > Color Gain**.
- 3 Select an option:
  - To increase or decrease the color intensity manually, select **Up** or **Down**.
  - To use the default setting, select **Default**.

## Sonar Recordings

### Recording the Sonar Display

**NOTE:** Not all models support sonar recording.

- 1 Insert a memory card into the card slot.
- 2 From a sonar view, select **MENU > Sonar Setup > Sonar Recording > Record Sonar**.

15 minutes of sonar recording uses approximately 200 MB of space of the inserted memory card. You can record sonar until the card reaches capacity.

### Stopping the Sonar Recording

Before you can stop recording sonar, you must begin recording it (*Recording the Sonar Display*, page 24).

From a sonar view, select **MENU > Sonar Setup > Sonar Recording > Stop Recording**.

### Deleting a Sonar Recording

- 1 Insert a memory card into the card slot.
- 2 From a sonar view, select **MENU > Sonar Setup > Sonar Recordings > View Recordings**.
- 3 Select a recording.
- 4 Select **Delete**.

### Playing Sonar Recordings

Before you can play back the sonar recordings, you must download and install the HomePort™ application and record sonar data onto a memory card.



- 1 Remove the memory card from the device.
- 2 Insert the memory card into a card reader attached to a computer.
- 3 Open the HomePort application.
- 4 Select a sonar recording from your device list.
- 5 Right-click the sonar recording in the lower pane.
- 6 Select **Playback**.

## Traditional, Garmin ClearVü, and SideVü Sonar Setup

**NOTE:** Not all options and settings apply to all models and transducers.

**NOTE:** These settings do not apply to Panoptix transducers.

From a sonar view, select **MENU > Sonar Setup**.

**Scroll Speed:** Sets the rate at which the sonar scrolls from right to left (*Setting the Scroll Speed, page 25*).

In shallow water, you can select a slower scroll speed to extend the length of time the information is displayed on screen. In deeper water, you can select a faster scroll speed. Automatic scroll speed adjusts the scrolling speed to the speed the boat is traveling.

**Noise Reject:** Reduces the interference and the amount of clutter shown on the sonar screen (*Sonar Noise Rejection Settings, page 25*).

**Appearance:** Configures the appearance of the sonar screen (*Sonar Appearance Settings, page 25*).

**Alarms:** Sets sonar alarms (*Sonar Alarms, page 26*).

**Advanced:** Configures various sonar display and data source settings (*Advanced Sonar Settings, page 26*). Not applicable to Garmin ClearVü or SideVü sonar views.

**Installation:** Configures the transducer (*Traditional, Garmin ClearVü, and SideVü Transducer Installation Settings, page 26*).

### Setting the Zoom Level on the Sonar Screen

- 1 From a sonar view, select **MENU > Zoom**.
- 2 Select an option:
  - To zoom in on the sonar data from the bottom depth, select **Bottom Lock**.
  - To set the depth range of the magnified area manually, select **Set Zoom**, select **View Up** or **View Down** to set the depth range of the magnified area, and select **Zoom In** or **Zoom Out** to increase or decrease the magnification of the magnified area.
  - To set the depth and zoom automatically, select **Set Zoom > Auto**.
  - To cancel the zoom, select **No Zoom**.

### Setting the Scroll Speed

You can set the rate at which the sonar image moves across the screen. A higher scroll speed shows more detail, especially while moving or trolling. A lower scroll speed displays sonar information on the screen longer. Setting the scroll speed on one sonar view applies to all the sonar views.

- 1 From a sonar view, select **MENU > Sonar Setup > Scroll Speed**.
- 2 Select an option:
  - To adjust the scroll speed automatically using speed-over-ground or water speed data, select **Auto**.

The Auto setting selects a scroll rate to match the boat speed, so targets in the water are drawn with the correct aspect ratio and appear less distorted. When viewing Garmin ClearVü or SideVü sonar views, it is recommend to use the Auto setting.

- To use a very fast scroll speed, select **Ultrascroll®**.  
The Ultrascroll option quickly scrolls new sonar data, but with a reduced image quality. For most situations, the Fast option provides a good balance between a quickly scrolling image and targets that are less distorted.

### Adjusting the Range of the Depth or Width Scale

You can adjust the range of the depth scale traditional and Garmin ClearVü sonar views and the range of the width scale for the SideVü sonar view.

Allowing the device to adjust the range automatically keeps the bottom within the lower or outer third of the sonar screen, and can be useful for tracking a bottom that has minimal or moderate terrain changes.

Manually adjusting the range enables you to view a specified range, which can be useful for tracking a bottom that has large terrain changes, such as a drop-offs or cliffs. The bottom can appear on the screen as long as it appears within the range you have set.

- 1 From a sonar view, select **MENU > Range**.
- 2 Select an option:
  - To allow the chartplotter to adjust the range automatically, select **Auto**.
  - To increase or decrease the range manually, select **Up** or **Down**.

**TIP:** From the sonar screen, you can select **+** or **-** to manually adjust the range.

**TIP:** When viewing multiple sonar screens, you can select **SELECT** to choose the active screen.

### Sonar Noise Rejection Settings

From a sonar view, select **MENU > Sonar Setup > Noise Reject**.

**Interference:** Adjusts the sensitivity to reduce the effects of interference from nearby sources of noise.

The lowest interference setting that achieves the desired improvement should be used to remove interference from the screen. Correcting installation issues that cause noise is the best way to eliminate interference.

**Color Limit:** Hides part of the color palette to help eliminate fields of weak clutter.

By setting the color limit to the color of the undesired returns, you can eliminate the display of undesired returns on the screen.

**Smoothing:** Removes noise that is not part of a normal sonar return, and adjusts the appearance of returns, such as the bottom.

When smoothing is set to high, more of the low-level noise remains than when using the interference control, but the noise is more subdued because of averaging. Smoothing can remove speckle from the bottom. Smoothing and interference work well together to eliminate low-level noise. You can adjust the interference and smoothing settings incrementally to remove undesirable noise from the display.

**Surface Noise:** Hides surface noise to help reduce clutter. Wider beam widths (lower frequencies) can show more targets, but can generate more surface noise.

**TVG:** Adjusts the time varying gain, which can reduce noise.

This control is best used for situations when you want to control and suppress clutter or noise near the water surface. It also allows for the display of targets near the surface that are otherwise hidden or masked by surface noise.

### Sonar Appearance Settings

From a sonar view, select **MENU > Sonar Setup > Appearance**.

**Color:** Sets the color scheme and color gain.

**Overlay Data:** Sets the data shown on the sonar screen.

**A-Scope:** Displays a vertical flasher along the right side of the screen that shows instantaneously the range to targets along a scale.

**Depth Line:** Shows a quick-reference depth line.

**Edge:** Highlights the strongest signal from the bottom to help define the hardness or softness of the signal.

**Pic. Advance:** Allows the sonar picture to advance faster by drawing more than one column of data on the screen for each column of sounder data received. This is especially helpful when you are using the sounder in deep water, because the sonar signal takes longer to travel to the water bottom and back to the transducer.

The 1/1 setting draws one column of information on the screen per sounder return. The 2/1 setting draws two columns of information on the screen per sounder return, and so on for the 4/1 and 8/1 settings.

## Sonar Alarms

**NOTE:** Not all options are available on all transducers.

From an applicable sonar view, select **MENU > Sonar Setup > Alarms**.

You can also open the sonar alarms by selecting **Settings > Alarms > Sonar**.

**Shallow Water:** Sets an alarm to sound when the depth is less than the specified value.



**Deep Water:** Sets an alarm to sound when the depth is greater than the specified value.

**FrontVü Alarm:** Sets an alarm to sound when the depth in front of the vessel is less than the specified value, which can help you avoid running aground (*Setting the FrontVü Depth Alarm*, page 28). This alarm is available only with Panoptix FrontVü transducers.

**Water Temp.:** Sets an alarm to sound when the transducer reports a temperature that is 2°F (1.1°C) above or below the specified temperature.

**Contour:** Sets an alarm to sound when the transducer detects a suspended target within the specified depth from the surface of the water and from the bottom.

**Fish:** Sets an alarm to sound when the device detects a suspended target.

-  sets the alarm to sound when fish of all sizes are detected.
-  sets the alarm to sound only when medium or large fish are detected.
-  sets the alarm to sound only when large fish are detected.

## Advanced Sonar Settings

From a Traditional sonar view, select **MENU > Sonar Setup > Advanced**.

**Shift:** Allows you to set the depth range on which the sonar is focused. This allows you to zoom in a higher resolution in the focused depth.

When using shift, bottom tracking may not work effectively, because the sonar looks for data within the depth range of the focused area, which may not include the bottom. Using shift also can impact the scroll speed, because data outside the depth range of the focused area is not processed, which reduces the time required to receive and display the data. You can zoom in to the focused area, which enables you to evaluate target returns more closely at a higher resolution than just zooming alone.

**Echo Stretch:** Adjusts the size of the echoes on the screen to make it easier to see separate returns on the screen.

When targets are difficult to see ①, echo stretch makes the target returns more pronounced and easier to see on the screen. If the echo stretch value is too high, the targets blend together. If the value is too low ②, the targets are small and more difficult to see.

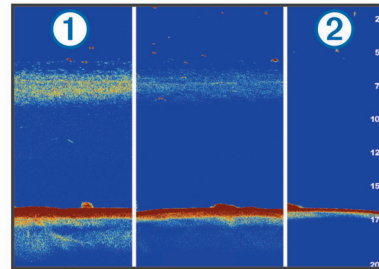

You can use echo stretch and filter width together to obtain the preferable resolution and noise reduction. With echo stretch and filter width set to low, the display has the highest resolution, but is the most susceptible to noise. With echo stretch set to high and filter width set to low, the display has a lower resolution, but has wider targets. With echo stretch and filter width set to high, the display has the lowest resolution, but is the least susceptible to noise. It is not recommended to set echo stretch to low and filter width to high.

## Traditional, Garmin ClearVü, and SideVü Transducer Installation Settings

From a Traditional, Garmin ClearVü, or SideVü sonar view, select **MENU > Sonar Setup > Installation**.

**Transmit Rate:** Sets the length of time between sonar pings.

Increasing the transmit rate increases the scroll speed, but it may also increase self-interference.

Reducing the transmit rate increases the spacing between transmit pulses and can resolve self-interference. This option is available on the Traditional sonar view only.

**Transmit Power:** Reduces transducer ringing near the surface. A lower transmit power value reduces transducer ringing, but can also reduce the strength of the returns. This option is available on the Traditional sonar view only.

**Filter Width:** Defines the edges of the target. A shorter filter more clearly defines the edges of the targets but may allow more noise. A longer filter creates softer target edges and may also reduce noise. This option is available on the Traditional sonar view only.

**Flip Left/Right:** Switches the SideVü view orientation from left to right. This option is available on the SideVü sonar view only.

**Restore Sonar Defaults:** Restores the sonar settings to the factory default values.

**Transducer Diagnostics:** Shows details about the transducer.

## Sonar Frequencies

**NOTE:** The frequencies available depend on the chartplotter, sounder modules, and transducer being used.

Adjusting the frequency helps adapt the sonar for your particular goals and the present depth of the water.

Higher frequencies use narrow beam widths, and are better for high-speed operation and rough sea conditions. Bottom definition and thermocline definition can be better when using a higher frequency.

Lower frequencies use wider beam widths, which can let the fisherman see more targets, but could also generate more surface noise and reduce bottom signal continuity during rough sea conditions. Wider beam widths generate larger arches for fish target returns, making them ideal for locating fish. Wider beam widths also perform better in deep water, because the lower frequency has better deep water penetration.

CHIRP frequencies allow you to sweep each pulse through a range of frequencies, resulting in better target separation in deep water. CHIRP can be used to distinctly identify targets, like individual fish in a school, and for deep water applications. CHIRP generally performs better than single frequency applications. Because some fish targets may show up better using a fixed frequency, you should consider your goals and water conditions when using CHIRP frequencies.

Some sonar black boxes and transducers also provide the ability to customize preset frequencies for each transducer element, which enables you to change the frequency quickly using the presets as the water and your goals change.

Viewing two frequencies concurrently using the split-frequency view allows you to see deeper with the lower frequency return and, at the same time, see more detail from the higher frequency return.

### Selecting Frequencies

**NOTE:** You cannot adjust the frequency for all sonar views and transducers.

You can indicate which frequencies appear on the sonar screen.

- 1 From a sonar view, select **MENU > Frequency**.
- 2 Select a frequency suited to your needs and water depth.

For more information on frequencies, see ([Sonar Frequencies, page 26](#)).

### Creating a Frequency Preset

**NOTE:** Not available with all transducers.

You can create a preset to save a specific sonar frequency, which allows you to change frequencies quickly.

- 1 From a sonar view, select **MENU > Frequency**.
- 2 Select **Manage Frequencies > New Preset**.
- 3 Enter a frequency.

### Turning On the A-Scope

**NOTE:** This feature is available in the Traditional sonar views.

The a-scope is a vertical flasher along the right side of the view, showing you what is underneath the transducer right now. You can use the a-scope to identify target returns that may be missed when the sonar data is quickly scrolling across the screen, such as when your boat is moving at high speeds. It can also be helpful for detecting fish that are close to the bottom.

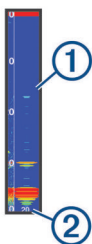

The a-scope above shows fish returns ① and a soft bottom return ②.

- 1 From a sonar view, select **MENU > Sonar Setup > Appearance > A-Scope > On**.
- 2 Select a hold time.

You can increase the hold time to increase the length of time the sonar returns are displayed.

## Panoptix Sonar Setup

### Adjusting the RealVü Viewing Angle and Zoom Level

You can change the viewing angle of the RealVü sonar views. You can also zoom in and out of the view.

From a RealVü sonar view, select an option:

- To adjust the viewing angle diagonally, select

- To adjust the viewing angle horizontally, select
- To adjust the viewing angle vertically, select
- To adjust the viewing angle, swipe the screen in any direction.
- To zoom in, spread two fingers apart.
- To zoom out, pinch two fingers together.

### Adjusting the RealVü Sweep Speed

You can update how quickly the transducer sweeps back and forth. A faster sweep rate creates a less detailed image, but the screen refreshes faster. A slower sweep rate creates a more detailed image, but the screen refreshes more slowly.

**NOTE:** This feature is not available for the RealVü 3D Historical sonar view.

- 1 From a RealVü sonar view, select **MENU > Sweep Speed**.
- 2 Select an option.

### LiveVü Forward and FrontVü Sonar Menu

From the LiveVü Forward or FrontVü sonar view, select **MENU**.

**Gain:** Controls the level of detail and noise shown on the sonar screen.

If you want to see the highest intensity signal returns on the screen, you can lower the gain to remove lower intensity returns and noise. If you want to see all return information, you can increase the gain to see more information on the screen. This also increases noise, and can make it more difficult to recognize actual returns.

**Depth Range:** Adjusts the range of the depth scale.

Allowing the device to adjust the range automatically keeps the bottom within the lower portion of the sonar screen, and can be useful for tracking a bottom that has minimal or moderate terrain changes.

Manually adjusting the range enables you to view a specified range, which can be useful for tracking a bottom that has large terrain changes, such as a drop-offs or cliffs. The bottom can appear on the screen as long as it appears within the range you have set.

**Forward Range:** Adjusts the range of the forward scale.

Allowing the device to adjust the range automatically adjusts the forward scale in relation to the depth. Manually adjusting the range enables you to view a specified range. The bottom can appear on the screen as long as it appears within the range you have set. Manually reducing this option can reduce the effectiveness of the FrontVü Alarm, reducing your reaction time to low depth readings.

**Transmit Angle:** Adjusts the focus of the transducer to the port or starboard side. This is available only with RealVü capable Panoptix FrontVü transducers, such as the PS30, PS31, and PS60.

**Transmit:** Stops the transducer from transmitting.

**FrontVü Alarm:** Sets an alarm to sound when the depth in front of the vessel is less than the specified value ([Setting the FrontVü Depth Alarm, page 28](#)). This is available only with Panoptix FrontVü transducers.

**Sonar Setup:** Adjusts the setup of the transducer and the appearance of the sonar returns.

**Edit Overlays:** Adjusts the data shown on the screen ([Customizing the Data Overlays, page 3](#)).

### Setting the LiveVü and FrontVü Transducer Transmit Angle

This feature is available only with Panoptix LiveVü and FrontVü transducers.

You can change the transducer transmit angle to aim the transducer at a particular area of interest. For example, you might aim the transducer to follow a bait ball or focus on a tree as you pass it.

- 1 From a LiveVü or FrontVü sonar view, select **MENU > Transmit Angle**.
- 2 Select an option.

### Setting the FrontVü Depth Alarm

#### ⚠ WARNING

The FrontVü depth alarm is a tool for situational awareness only, and may not prevent groundings in all circumstances. It is the obligation of the vessel operator to ensure safe operation of the vessel.

This alarm is available only with Panoptix FrontVü transducers.

You can set an alarm to sound when the depth is below a specified level. For best results, you should set the bow offset when using the front collision alarm ([Setting the Bow Offset, page 28](#)).

- 1 From the FrontVü sonar view, select **MENU > FrontVü Alarm**.
- 2 Select **On**.
- 3 Enter the depth at which the alarm is triggered, and select **Done**.

On the FrontVü screen, a depth line shows the depth at which the alarm is set. The line is green when you are in a safe depth. The line turns yellow when you are going faster than the forward range gives you time to react (10 seconds). It turns red and sounds an alarm when the system detects an obstruction or the depth is less than the entered value.

#### ⚠ CAUTION

The ability to effectively avoid running aground with FrontVü sonar decreases as your speed rises above 8 knots.

### LiveVü and FrontVü Appearance Settings

From a LiveVü or FrontVü Panoptix sonar view, select **MENU > Sonar Setup > Appearance**.

**Color Scheme:** Sets the color palette.

**Color Gain:** Adjusts the intensity of colors shown on the screen.

You can select a higher color gain value to see targets higher in the water column. A higher color gain value also allow you to differentiate low intensity returns higher in the water column, but this causes a loss in the differentiation of the returns at the bottom. You can select a lower color gain value when targets are near the bottom, to help you distinguish between targets and high intensity returns such as sand, rock, and mud.

**Trails:** Sets the how long the trails appear on the screen. The trails show the movement of the target.

**Bottom Fill:** Colors the bottom brown to distinguish it from the water returns.

**Grid Overlay:** Shows a grid of range lines.

**Scroll History:** Shows the sonar history in a traditional sonar view.

### RealVü Appearance Settings

From a RealVü sonar view, select **MENU > Sonar Setup > Appearance**.

**Point Colors:** Sets a different color palette for the sonar return points.

**Bottom Colors:** Sets the color scheme for the bottom.

**Bottom Style:** Sets the style for the bottom. When you are in deep water, you can select the Points option and manually set the range to a shallower value.

**Color Key:** Shows a legend of the depths the colors represent.

### Panoptix Transducer Installation Settings

From a Panoptix sonar view, select **MENU > Sonar Setup > Installation**.

**Install Depth:** Sets the depth below the water line where the Panoptix transducer is mounted. Entering the actual depth at which the transducer is mounted results in a more accurate visual presentation of what is in the water.

**Bow Offset:** Sets the distance between the bow and the forward view Panoptix transducer installation location. This allows you to view the forward distance from the bow instead of the transducer location.

This applies to Panoptix transducers in the FrontVü, LiveVü Forward, and RealVü 3D Forward sonar views.

**Beam Width:** Sets the width of the down view Panoptix transducer beam. Narrow beam widths allow you to see deeper and farther. Wider beam widths allow you to see more coverage area.

This applies to Panoptix transducers in the FrontVü, LiveVü Down, and LiveVü Forward sonar views.

**Use AHRS:** Enables the internal attitude heading and reference system (AHRS) sensors to detect the installation angle of the Panoptix transducer automatically. When this setting is turned off, you can enter the specific installation angle for the transducer using the Pitch Angle setting. Many forward view transducers are installed at a 45-degree angle and down view transducers are installed at a zero-degree angle.

**Flipped:** Sets the orientation of the Panoptix sonar view when the down view transducer is installed with the cables pointing toward the port side of the boat.

This applies to Panoptix transducers in the LiveVü Down, RealVü 3D Down, and RealVü 3D Historical sonar views.

**Calibrate Compass:** Calibrates the internal compass in the Panoptix transducer ([Calibrating the Compass, page 23](#)).

This applies to Panoptix transducers with an internal compass, such as the PS21-TR transducer.

**Restore Sonar Defaults:** Restores the sonar settings to the factory default values.

### Setting the Bow Offset

For forward view Panoptix transducers, you can enter a bow offset to compensate the forward distance readings for the transducer installation location. This allows you to view the forward distance from the bow instead of the transducer installation location.

This feature applies to Panoptix transducers in the FrontVü, LiveVü Forward, and RealVü 3D Forward sonar views.

- 1 Measure the horizontal distance ① from the transducer to the bow.

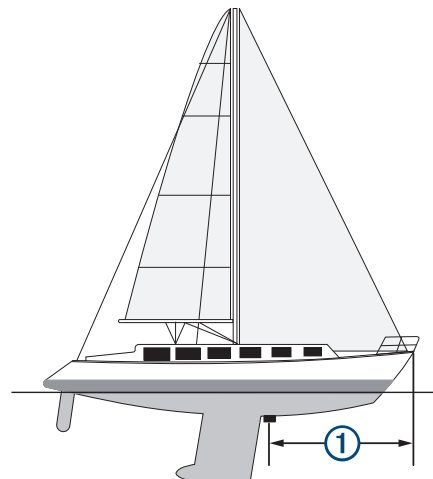

- 2 From an applicable sonar view, select **MENU > Sonar Setup > Installation > Bow Offset**.
- 3 Enter the distance measured, and select **Done**.

On the applicable sonar view, the forward range shifts by the distance you entered.

## Radar

### ⚠ WARNING

The marine radar transmits microwave energy that has the potential to be harmful to humans and animals. Before beginning radar transmission, verify that the area around the radar is clear. The radar transmits a beam approximately 12° above and below a line extending horizontally from the center of the radar.

When the radar is transmitting, do not look directly at the antenna at close range; eyes are the most sensitive part of the body to electromagnetic energy.

When you connect your compatible chartplotter to an optional Garmin marine radar, such as a GMR™ Fantom™ 6 radar or a GMR 24 xHD, you can view more information about your surroundings.

The radar transmits a narrow beam of microwave energy as it rotates to a 360° pattern. When the transmitted energy contacts a target, some of that energy is reflected back to the radar.

### Radar Interpretation

Reading and interpreting the radar display takes practice. The more you use the radar, the better you will become at relying on the radar display when you really need it.

Radar can be useful in many situations, such as avoiding collisions when you have limited visibility, for example when it is dark or foggy, tracking weather, seeing what is ahead of you, and locating birds and fish.

The radar overlay feature can help you interpret the radar display more easily, because it overlays the radar returns on top of the chart. This can help you identify the difference between a radar return of a land mass, bridge, or rain cloud. Showing the AIS vessels on the radar overlay can also help you identify features on the radar display.

In the screenshot below, the radar overlay is turned on. This screen also shows a video feed. We can easily identify a few items on the radar screen.

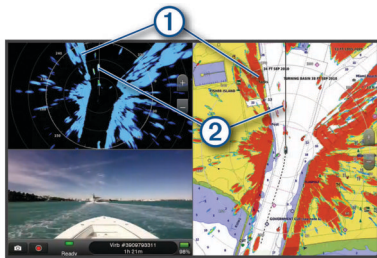

①	Land
②	Vessel

### Radar Overlay

When you connect your chartplotter to an optional Garmin marine radar, you can use overlay radar information on the Navigation chart or on the Fishing chart.

Data appears on the radar overlay based on the most recently used radar mode and all settings configurations applied to the radar overlay are also applied to the last-used radar mode.

### Radar Overlay and Chart Data Alignment

When using the Radar overlay, the chartplotter aligns radar data with chart data based on the boat heading, which is based by default on data from a magnetic heading sensor connected using a NMEA 0183 or NMEA 2000 network. If a heading sensor

is not available, the boat heading is based on GPS tracking data.

GPS tracking data indicates the direction in which the boat is moving, not the direction in which the boat is pointing. If the boat is drifting backward or sideways due to a current or wind, the Radar overlay may not perfectly align with the chart data. This situation should be avoided by using boat-heading data from an electronic compass.

If the boat heading is based on data from a magnetic heading sensor or an automatic pilot, the heading data could be compromised due to incorrect setup, mechanical malfunction, magnetic interference, or other factors. If the heading data is compromised, the Radar overlay may not align perfectly with the chart data.

### Transmitting Radar Signals

**NOTE:** As a safety feature, the radar enters standby mode after it warms up. This gives you an opportunity to verify the area around the radar is clear before beginning radar transmission.

- 1 With the chartplotter off, connect your radar as described in the radar installation instructions.
- 2 Turn on the chartplotter.  
If necessary, the radar warms up and a countdown alerts you when the radar is ready.
- 3 Select **Radar**.
- 4 Select a radar mode.  
A countdown message appears while the radar is starting up.
- 5 Select **MENU > Transmit Radar**.

### Stopping the Transmission of Radar Signals

From a radar screen, select **MENU > Radar To Standby**.

**TIP:** Press **⏻ > Radar To Standby** from any screen to quickly stop radar transmission.

### Setting Up the Timed Transmit Mode

To help conserve power, you can set up time intervals in which the radar will transmit and not transmit (standby) signal transmissions.

**NOTE:** This feature is not available in dual radar modes.

- 1 From a radar screen, select **MENU > Radar Options > Timed Transmit**.
- 2 Select **Timed Transmit** to enable the option.
- 3 Select **Stdby Time**, enter the time interval between radar signal transmissions, and select **Done**.
- 4 Select **Transmit Time**, enter the duration of each radar signal transmission, and select **Done**.

### Enabling and Adjusting a Radar No Transmit Zone

You can indicate areas within which the radar scanner does not transmit signals.

**NOTE:** GMR Fantom and xHD2 radar models support two no-transmit zones. Other GMR radar models support one no-transmit zone.

- 1 From a radar screen, select **MENU > Radar Setup > Installation > Enable No Transmit Zone**.  
The no-transmit zone is indicated by a shaded area on the radar screen.
- 2 Select .
- 3 Select **Adjust No Transmit Zone > Move No Transmit Zone**.
- 4 Select **Angle 1**, and select the new location for the first angle.
- 5 Select **Angle 2**, and select the new location for the second angle.
- 6 Select **Done**.

## Adjusting the Radar Range

The range of the radar signal indicates the length of the pulsed signal transmitted and received by the radar. As the range increases, the radar transmits longer pulses in order to reach distant targets. Closer targets, especially rain and waves, also reflect the longer pulses, which can add noise to the Radar screen. Viewing information about longer-range targets can also decrease the amount of space available on the Radar screen for viewing information about shorter-range targets.

- Turn the knob to increase or decrease the range.

### Tips for Selecting a Radar Range

- Determine what information you need to see on the Radar screen.  
For example, do you need information about nearby weather conditions or targets and traffic, or are you more concerned about distant weather conditions?
- Assess the environmental conditions where the radar is being used.  
Especially in inclement weather, longer-range radar signals can increase the clutter on the Radar screen and make it more difficult to view information about shorter-range targets. In rain, shorter-range radar signals can enable you to view information about nearby objects more effectively, if the rain clutter setting is configured optimally.
- Select the shortest effective range, given your reason for using radar and the present environmental conditions.

## MotionScope™ Doppler Radar Technology

The GMR Phantom radar uses the Doppler effect to detect and highlight moving targets to help you avoid potential collisions, find flocks of birds, and track weather formations. The Doppler effect is the frequency shift in the radar echo due to the relative motion of the target. This allows for instant detection of any targets moving toward or away from the radar.

The MotionScope feature highlights the moving targets on the radar display so you can navigate around other boats or severe weather, or toward fishing spots where birds are feeding at the surface.

The moving targets are color-coded so you can tell at a glance which targets are heading your way and which are heading away from you. On most color schemes, green indicates the target is moving away from you and red indicates the target is moving toward you.

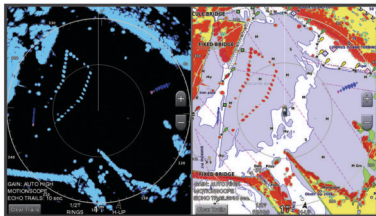

## Enabling a Guard Zone

You can enable a guard zone to alert you when anything comes within a specified area around your boat.

**NOTE:** This feature is not available in dual radar modes.

From a radar screen, select **MENU > Radar Options > Enable Guard Zone**.

### Defining a Circular Guard Zone

Before you can define the boundaries of the guard zone, you must enable a guard zone ([Enabling a Guard Zone, page 30](#)).

You can define a circular guard zone that completely surrounds your boat.

- 1 From a radar screen, select **MENU > Radar Options > Adjust Guard Zone > Adjust Guard Zone > Circle**.
- 2 Select the location of the outer guard zone circle.
- 3 Select the location of the inner guard zone circle to define the width of the guard zone.

### Defining a Partial Guard Zone

Before you can define the boundaries of the guard zone, you must enable a guard zone ([Enabling a Guard Zone, page 30](#)).

You can define the boundaries of a guard zone that does not completely surround your boat.

- 1 From a radar screen, select **MENU > Radar Options > Adjust Guard Zone > Adjust Guard Zone > Corner 1**.
- 2 Touch and drag the location of the outer guard-zone corner ①.

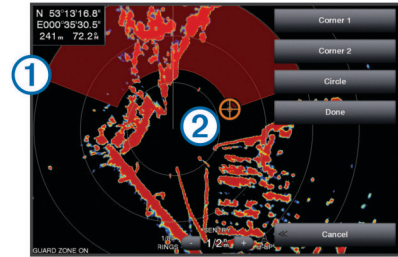

- 3 Select **Corner 2**.
- 4 Touch the location of the inner guard-zone corner ② to define the width of the guard zone.
- 5 Select **Done**.

### Disabling a Guard Zone

You can disable a guard zone.

From a radar screen, select **MENU > Radar Options > Adjust Guard Zone > Disable Guard Zone**.

The guard zone configuration is saved, so you can enable it again when needed.

## MARPA

Mini-automatic radar plotting aid (MARPA) enables you to identify and track targets and is primarily used for collision avoidance. To use MARPA, you assign a MARPA tag to a target. The radar system automatically tracks the tagged object and provides you with information about the object, including the range, bearing, speed, GPS heading, nearest approach, and time to nearest approach. MARPA indicates the status of each tagged object (acquiring, lost, tracking, or dangerous), and the chartplotter can sound a collision alarm if the object enters your safe zone.

### MARPA Targeting Symbols

	Acquiring a target. Concentric, dashed green rings radiate from the target while the radar is locking onto it.
	Target has been acquired. A solid green ring indicates the location of a target that the radar has locked onto. A dashed green line attached to the circle indicates the projected course over ground or the GPS heading of the target.
	Dangerous target is in range. A red ring flashes from the target while an alarm sounds and a message banner appears. After the alarm has been acknowledged, a solid red dot with a dashed red line attached to it indicates the location and the projected course over ground or the GPS heading of the target. If the safe-zone collision alarm has been set to Off, the target flashes, but the audible alarm does not sound and the alarm banner does not appear.
	Target has been lost. A solid green ring with an X through it indicates that the radar could not lock onto the target.
	Closest point of approach and time to closest point of approach to a dangerous target.

## Assigning a MARPA Tag to an Object

Before you can use MARPA, you must have a heading sensor connected and an active GPS signal. The heading sensor must provide the NMEA 2000 parameter group number (PGN) 127250 or the NMEA 0183 HDM or HDG output sentence.

- 1 From a radar screen, select an object or location.
- 2 Select **Acquire Target > MARPA Target**.

## Removing a MARPA Tag from a Targeted Object

- 1 From the Radar screen, select a MARPA target.
- 2 Select **MARPA Target > Remove**.

## Viewing Information about a MARPA-tagged Object

You can view the range, bearing, speed, and other information about a MARPA-tagged object.

- 1 From a radar screen, select a targeted object.
- 2 Select **MARPA Target**.

## Viewing a List of AIS and MARPA Threats

From any Radar screen or the Radar overlay, you can view and customize the appearance of a list of AIS and MARPA threats.

- 1 From a Radar screen, select **MENU > Layers > Other Vessels > List > Show**.
- 2 Select the type of threats to include in the list.

## Showing AIS Vessels on the Radar Screen

AIS requires the use of an external AIS device and active transponder signals from other vessels.

You can configure how other vessels appear on the Radar screen. If any setting (except the AIS display range) is configured for one radar mode, the setting is applied to every other radar mode. The details and projected heading settings configured for one radar mode are applied to every other radar mode and to the Radar overlay.

- 1 From a Radar screen or the Radar overlay, select **MENU > Other Vessels > Display Setup**.
- 2 Select an option:
  - To indicate the distance from your location within which AIS vessels appear, select **Display Range**, and select a distance.
  - To show details about AIS-activated vessels, select **Details > Show**.
  - To set the projected heading time for AIS-activated vessels, select **Proj. Heading**, and enter the time.
  - To show the tracks of AIS vessels, select **Tracks**, and select the length of the track that appears.

## VRM and EBL

The variable range marker (VRM) and the electronic bearing line (EBL) measure the distance and bearing from your boat to a target object. On the Radar screen, the VRM appears as a circle that is centered on the present location of your boat, and the EBL appears as a line that begins at the present location of your boat and intersects the VRM. The point of intersection is the target of the VRM and the EBL.

### Showing the VRM and the EBL

From a radar screen, select **MENU > Radar Options > Show VRM/EBL**.

### Adjusting the VRM and the EBL

Before you can adjust the VRM and the EBL, you must show them on the Radar screen ([Showing the VRM and the EBL, page 31](#)).

You can adjust the diameter of the VRM and the angle of the EBL, which moves the intersection point of the VRM and the EBL. The VRM and the EBL configured for one mode are applied to all other radar modes.

- 1 From a Radar screen, select a new location for the intersection point of the VRM and the EBL.
- 2 Select **Drop VRM/EBL**.
- 3 Select **Stop Pointing**.

## Measuring the Range and Bearing to a Target Object

Before you can adjust the VRM and the EBL, you must show them on the Radar screen ([Showing the VRM and the EBL, page 31](#)).

- 1 From a Radar screen, select the target location.
- 2 Select **Measure**.

The range and the bearing to the target location appear in the upper-left corner of the screen.

## Echo Trails

The echo trails feature enables you to track the movement of vessels on the radar display. As a vessel moves, you can see a faint trail ① of the vessel's wake. You can change the length of time the trail is displayed.

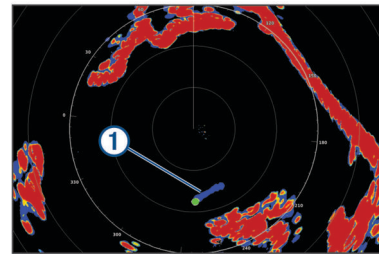

**NOTE:** Depending upon the radar in use, the settings configured for use in one radar mode may or may not be applied to other radar modes or to the radar overlay.

**NOTE:** This feature is not available on xHD open array or HD/HD+ radome models.

## Turning on Echo Trails

From a radar screen, select **MENU > Radar Options > Echo Trails > Display**.

## Adjusting the Length of the Echo Trails

- 1 From a radar screen or the radar overlay, select **MENU > Radar Options > Echo Trails > Time**.
- 2 Select the length of the trail.

## Clearing the Echo Trails

You can remove the echo trails from the radar screen to reduce the clutter on the screen.

From a radar screen, select **MENU > Radar Options > Echo Trails > Clear Trails**.

## Optimizing the Radar Display

You can adjust the radar display settings for reduced clutter and increased accuracy.

**NOTE:** You can optimize the radar display for each radar mode.

- 1 Select a radar range ([Adjusting the Radar Range, page 30](#)).
- 2 Restore the default value of the gain setting ([Adjusting Gain on the Radar Screen Automatically, page 31](#)).
- 3 Adjust the gain setting manually ([Adjusting Gain on the Radar Screen Manually, page 32](#)).

## Radar Gain and Clutter

### Adjusting Gain on the Radar Screen Automatically

The automatic gain setting for each radar mode is optimized for that mode, and may differ from the automatic gain setting used for another mode.

**NOTE:** Depending upon the radar in use, the gain setting configured for use in one radar mode may or may not be applied to other radar modes or to the Radar overlay.

**NOTE:** Not all options are available on all radar models.

- 1 From a radar screen or the radar overlay, select **MENU > Gain**.
- 2 Select an option:
  - To adjust the gain automatically for changing conditions, select **Auto Low** or **Auto High**.
  - To adjust the gain automatically to show birds over the surface of the water, select **Auto Bird**.

**NOTE:** This option is not available on xHD open array or HD/HD+ radome models.

### **Adjusting Gain on the Radar Screen Manually**

For optimal radar performance, you can manually adjust the gain.

**NOTE:** Depending upon the radar in use, the gain setting configured for use in one radar mode may or may not be applied to other radar modes or to the Radar overlay.

- 1 From a Radar screen or the Radar overlay, select **MENU > Gain**.
- 2 Select **Up** to raise the gain, until light speckles appear across the Radar screen.

Data on the Radar screen is refreshed every few seconds. As a result, the effects of manually adjusting the gain may not appear instantly. Adjust the gain slowly.
- 3 Select **Down** to lower the gain until the speckles disappear.
- 4 If boats, land, or other targets are within range, select **Down** to lower the gain until the targets begin to blink.
- 5 Select **Up** to raise the gain until the boats, land, or other targets appear steadily lit on the Radar screen.
- 6 Minimize the appearance of nearby large objects, if necessary.
- 7 Minimize the appearance of side-lobe echoes, if necessary.

### **Minimizing Nearby Large-Object Interference**

Nearby targets of significant size, such as jetty walls, can cause a very bright image of the target to appear on the Radar screen. This image can obscure smaller targets located near it.

**NOTE:** Depending upon the radar in use, the gain setting configured for use in one radar mode may or may not be applied to other radar modes or to the Radar overlay.

- 1 From a Radar screen or the Radar overlay, select **MENU > Gain**.
- 2 Select **Down** to lower the gain until the smaller targets are clearly visible on the Radar screen.

Reducing the gain to eliminate nearby large-object interference may cause smaller or distant targets to blink or disappear from the Radar screen.

### **Minimizing Side-Lobe Interference on the Radar Screen**

Side-lobe interference may appear to streak outward from a target in a semi-circular pattern. Side-lobe effects can be avoided by reducing the gain or reducing the radar range.

**NOTE:** Depending upon the radar in use, the gain setting configured for use in one radar mode may or may not be applied to other radar modes or to the Radar overlay.

- 1 From a Radar screen or the Radar overlay, select **MENU > Gain**.
- 2 Select **Down** to lower the gain until the semi-circular, streaked pattern disappears from the Radar screen.

Reducing the gain to eliminate side-lobe interference may cause smaller or distant targets to blink or disappear from the Radar screen.

### **Adjusting Sea Clutter on the Radar Screen Automatically**

You can set the chartplotter to automatically adjust the appearance of clutter caused by choppy sea conditions.

**NOTE:** Depending upon the radar in use, the sea clutter setting configured for use in one radar mode may or may not be applied to other radar modes or to the radar overlay.

**NOTE:** Not all options and settings are available on all radar and chartplotter models.

- 1 From a radar screen or the radar overlay, select **MENU > Sea Clutter**.
- 2 Select **Presets** or **Auto**.
- 3 Select a setting that reflects the present sea conditions.

When using a compatible radar model, the chartplotter adjusts the sea clutter based on the sea conditions automatically.

### **Adjusting Sea Clutter on the Radar Screen Manually**

You can adjust the appearance of clutter caused by choppy sea conditions. The sea clutter setting affects the appearance of nearby clutter and targets more than it affects the appearance of distant clutter and targets. A higher sea clutter setting reduces the appearance of clutter caused by nearby waves, but it can also reduce or eliminate the appearance of nearby targets.

**NOTE:** Depending upon the radar in use, the sea clutter setting configured for use in one radar mode may or may not be applied to other radar modes or to the radar overlay.

- 1 From a radar screen or the radar overlay, select **MENU > Sea Clutter**.
- 2 Select **Up** or **Down** to adjust the appearance of sea clutter until other targets are clearly visible on the radar screen.

Clutter caused by sea conditions may still be visible.

### **Adjusting Rain Clutter on the Radar Screen**

You can adjust the appearance of clutter caused by rain. Reducing the radar range also can minimize rain clutter ([Adjusting the Radar Range, page 30](#)).

The rain clutter setting affects the appearance of nearby rain clutter and targets more than it affects the appearance of distant rain clutter and targets. A higher rain clutter setting reduces the appearance of clutter caused by nearby rain, but it can also reduce or eliminate the appearance of nearby targets.

**NOTE:** Depending upon the radar in use, the rain clutter settings configured for use in one radar mode may or may not be applied to other radar modes or to the radar overlay.

- 1 From a radar screen, select **MENU > Radar Options > Rain Clutter**.
- 2 Select **Up** or **Down** to decrease or increase the appearance of nearby rain clutter until other targets are clearly visible on the radar screen.

Clutter caused by rain may still be visible.

### **Reducing Cross Talk Clutter on the Radar Screen**

You can reduce the appearance of clutter caused by interference from another nearby radar source, when the cross talk reject setting is on.

**NOTE:** Depending upon the radar in use, the cross talk reject setting configured for use in one radar mode may or may not be applied to other radar modes or to the Radar overlay.

From a Radar screen or the Radar overlay, select **MENU > Radar Setup > Crosstalk Rej.**

### **Radar Options Menu**

From a radar screen, select **MENU > Radar Options**.

**MotionScope™:** Uses the Doppler effect to detect and highlight moving targets to help you avoid potential collisions, find flocks of birds, and track weather formations ([MotionScope™ Doppler Radar Technology, page 30](#)). This option is only available on Fantom models.



**Pulse Exp.:** Increases the duration of the transmit pulse, which helps maximize the energy directed toward targets. This helps to enhance the detection and identification of targets. This option is not available on xHD open array or HD/HD+ radome models.

**Target Size:** Adjusts the size of targets, by adjusting the pulse compression processing. Select smaller targets for a sharp, high resolution radar image. Select larger targets to display larger echos for point targets, like boats and buoys. This option is only available on Fantom models.

**Echo Trails:** Enables you to track the movement of vessels on the radar screen. This option is not available on xHD open array or HD/HD+ radome models.

**Rain Clutter:** Reduces the clutter caused by rain ([Adjusting Rain Clutter on the Radar Screen, page 32](#)).

**Show VRM/EBL:** Shows the variable range marker (VRM) circle and the electronic bearing line (EBL) to allow you to measure the distance and bearing from your boat to a target object ([VRM and EBL, page 31](#)).

**Enable Guard Zone:** Sets a safe zone around your boat and sounds an alarm when anything enters the zone ([Enabling a Guard Zone, page 30](#)).

**Timed Transmit:** Helps conserve power by transmitting radar signals at set intervals.

## Radar Setup Menu

From a radar screen, select **MENU > Radar Setup**.

**Source:** Selects the radar source when more than one radar is connected to the network.

**Chart Display:** Shows the chart under the radar image. When enabled, the Layers menu appears.

**Orientation:** Sets the perspective of the radar display.

**Crosstalk Rej.:** Reduces the appearance of clutter caused by interference from another nearby radar source.

**Rotation Spd.:** Sets the preferred speed at which the radar rotates. The High Speed option can be used to increase the refresh rate. In some situations, the radar automatically rotates at the normal speed to improve detection, for example, when a longer range is selected or when MotionScope or Dual range is used.

**Appearance:** Sets the color scheme, look-ahead speed, and navigation appearance.

**Installation:** Allows you to configure the radar for the installation, such as setting the front of the boat and the antenna park position.

## Radar Appearance Settings

From a radar screen, select **MENU > Radar Setup > Appearance**.

**NOTE:** These settings do not apply to the radar overlay.

**Bkgd. Color:** Sets the color for the background.

**Foreground Clr.:** Sets the color scheme for the radar returns.

**Look-Ahead Speed:** Shifts your present location toward the bottom of the screen automatically as your speed increases. Enter your top speed for the best results.

**Heading Line:** Shows an extension from the bow of the boat in the direction of travel on the radar screen.

**Range Rings:** Shows the range rings that help you to visualize distances on the radar screen.

**Bearing Ring:** Shows a bearing relative to your heading or based on a north reference, to help you determine the bearing to an object shown on the radar screen.

**Nav Lines:** Shows the navigation lines that indicate the course you have set using Route To, Auto Guidance, or Go To.

**Waypoints:** Shows waypoints on the radar screen.

## Radar Installation Settings

**Front of Boat:** Compensates for the physical location of the radar when it is not on the boat axis ([Front-of-Boat Offset, page 33](#)).

**Antenna Configuration:** Sets the radar antenna size and sets the position in which the radar stops ([Setting a Custom Park Position, page 33](#)).

**Enable No Transmit Zone:** Sets the area in which the radar does not transmit signals ([Enabling and Adjusting a Radar No Transmit Zone, page 29](#)).

### Front-of-Boat Offset

The front-of-boat offset compensates for the physical location of the radar scanner on a boat, if the radar scanner does not align with the bow-stern axis.

### Measuring the Potential Front-of-Boat Offset

The front-of-boat offset compensates for the physical location of the radar scanner on a boat, if the radar scanner does not align with the bow-stern axis.

- 1 Using a magnetic compass, take an optical bearing of a stationary target located within viewable range.
- 2 Measure the target bearing on the radar.
- 3 If the bearing deviation is more than  $\pm 1^\circ$ , set the front-of-boat offset.

### Setting the Front-of-Boat Offset

Before you can set the front-of-boat offset, you must measure the potential front-of-boat offset.

The front-of-boat offset setting configured for use in one radar mode is applied to every other radar mode and to the Radar overlay.

- 1 From a Radar screen or the Radar overlay, select **MENU > Radar Setup > Installation > Front of Boat**.
- 2 Select **Up** or **Down** to adjust the offset.

### Setting a Custom Park Position

If you have more than one radar on your boat, you must be viewing the radar screen for the radar you want to adjust.

By default, the antenna is stopped perpendicular to the pedestal when it is not spinning. You can adjust this position.

- 1 From the radar screen, select **MENU > Radar Setup > Installation > Antenna Configuration > Park Position**.
- 2 Use the slider bar to adjust the position of the antenna when stopped, and select **BACK**.

## Selecting a Different Radar Source

- 1 Select an option:
  - From a radar screen or the radar overlay, select **MENU > Radar Setup > Source**.
  - Select **Settings > Communications > Preferred Sources > Radar**.
- 2 Select the radar source.

## Changing the Radar Mode

- 1 From a combination screen or SmartMode layout with radar, select **MENU > Radar Menu > Change Radar**.
- 2 Select a radar mode.

## Autopilot

### WARNING

You can use the autopilot feature only at a station installed next to a helm, throttle, and helm control device.

You are responsible for the safe and prudent operation of your vessel. The autopilot is a tool that enhances your capability to operate your boat. It does not relieve you of the responsibility of

safely operating your boat. Avoid navigational hazards and never leave the helm unattended.

Always be prepared to promptly regain manual control of your boat.

Learn to operate the autopilot on calm and hazard-free open water.

Use caution when operating the autopilot near hazards in the water, such as docks, pilings, and other boats.

The autopilot system continuously adjusts the steering of your boat to maintain a constant heading (heading hold). The system also allows manual steering and several modes of automatic-steering functions and patterns.

When the chartplotter is connected to a compatible Garmin autopilot system, you can engage and control the autopilot from the chartplotter.

For information about compatible Garmin autopilot systems, go to [www.garmin.com](http://www.garmin.com).

## Opening the Autopilot Screen

Before you can open the autopilot screen, you must have a compatible Garmin autopilot installed and configured.

Select **A/V, Gauges, Controls > Autopilot**.

## Autopilot Screen

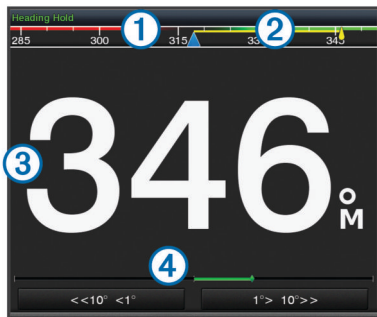

①	Actual heading
②	Intended heading (heading the autopilot is steering toward)
③	Actual heading (when in standby mode) Intended heading (when engaged)
④	Rudder position indicator (This functionality is available only when a rudder sensor is connected.)

### Adjusting the Step Steering Increment

- From the Autopilot screen, select **MENU > Autopilot Setup > Step Turn Size**.
- Select an increment.

### Setting the Power Saver

You can adjust the level of rudder activity.

- From the autopilot screen, select **MENU > Autopilot Setup > Power Mode Setup > Power Saver**.
- Select a percentage.

Selecting a higher percentage reduces rudder activity and heading performance. The higher the percentage, the more the course deviates before the autopilot corrects it.

**TIP:** In choppy conditions at low speeds, increasing the Power Saver percentage reduces rudder activity.

### Enabling Shadow Drive™

**NOTE:** The Shadow Drive feature is available only on hydraulic steering systems.

From the autopilot screen, select **MENU > Autopilot Setup > Shadow Drive > Enabled**.

## Autopilot Overlay Bar



①	Actual heading
②	Intended heading (heading the autopilot is steering toward)
③	Actual heading (when in standby mode) Intended heading (when engaged)

## Engaging the Autopilot

When you engage the autopilot, the autopilot takes control of the helm and steers the boat to maintain your heading.

From any screen, select **Engage**.

Your intended heading shows in the center of the Autopilot screen.

### Adjusting the Heading with the Helm

**NOTE:** You must enable the Shadow Drive feature before you can adjust the heading using the helm (*Enabling Shadow Drive™*, page 34).

With the autopilot engaged, manually steer the boat.

The autopilot activates Shadow Drive mode.

When you release the helm and manually maintain a specific heading for a few seconds, the autopilot resumes a heading hold at the new heading.

### Adjusting the Heading with the Chartplotter in Step Steering Mode

Before you can steer your boat using the keys at the bottom of the autopilot screen, you must engage the autopilot (*Engaging the Autopilot*, page 34).

- Select **<1°** or **1°>** to initiate a single 1° turn.
  - Select **<<10°** or **10°>>** to initiate a single 10° turn.
  - Hold **<1°** or **1°>** to initiate a rate-controlled turn.
- The boat continues to turn until you let go of the key.
- Hold **<<10°** or **10°>>** to initiate a sequence of 10° turns.

## Steering Patterns

### ⚠ WARNING

You are responsible for the safe operation of your boat. Do not begin a pattern until you are certain that the water is clear of obstacles.

The autopilot can steer the boat in preset patterns for fishing, and it can also perform other specialty maneuvers such as U-turns and Williamson turns.

### Following the U-Turn Pattern

You can use the u-turn pattern to turn the boat around 180 degrees and maintain the new heading.

- From the autopilot screen, select **MENU > Pattern Steering > U-Turn**.
- Select **Engage Port** or **Engage Starboard**.

### Setting Up and Following the Circles Pattern

You can use the circles pattern to steer the boat in a continuous circle, in a specified direction, and at a specified time interval.

- From the autopilot screen, select **MENU > Pattern Steering > Circles**.
- If necessary, select **Time**, and select a time for the autopilot to steer one complete circle.
- Select **Engage Port** or **Engage Starboard**.

## Setting Up and Following the Zigzag Pattern

You can use the zigzag pattern to steer the boat from port to starboard and back, over a specified time and angle, across your present heading.

- 1 From the autopilot screen, select **MENU > Pattern Steering > Zigzag**.
- 2 If necessary, select **Amplitude**, and select a degree.
- 3 If necessary, select **Period**, and select a length of time.
- 4 Select **Engage Zigzag**.

## Following the Williamson Turn Pattern

You can use the Williamson turn pattern to steer the boat around with the intent of running alongside the location where the Williamson turn pattern was initiated. The Williamson turn pattern can be used in man overboard situations.

- 1 From the autopilot screen, select **MENU > Pattern Steering > Williamson Turn**.
- 2 Select **Engage Port** or **Engage Starboard**.

## Following an Orbit Pattern

You can use the orbit pattern to steer the boat in a continuous circle around the active waypoint. The size of the circle is defined by your distance from the active waypoint when you begin the orbit pattern.

- 1 From the autopilot screen, select **MENU > Pattern Steering > Orbit**.
- 2 Select **Engage Port** or **Engage Starboard**.

## Setting Up and Following the Cloverleaf Pattern

You can use the cloverleaf pattern to steer the boat to repeatedly pass over an active waypoint. When you begin the cloverleaf pattern, the autopilot drives the boat toward the active waypoint and begins the cloverleaf pattern.

You can adjust the distance between the waypoint and the location where the autopilot turns the boat for another pass over the waypoint. The default setting turns the boat at a range of 1000 ft. (300 m) from the active waypoint.

- 1 From the autopilot screen, select **MENU > Pattern Steering > Cloverleaf**.
- 2 If necessary, select **Length**, and select a distance.
- 3 Select **Engage Port** or **Engage Starboard**.

## Setting Up and Following a Search Pattern

You can use the search pattern to steer the boat in increasingly larger circles outward from the active waypoint, forming a spiral pattern. When you begin the search pattern, the autopilot drives the boat to the active waypoint and begins the pattern.

You can adjust the distance between each circle in the spiral. The default distance between circles is 50 ft. (20 m).

- 1 From the autopilot screen, select **MENU > Pattern Steering > Search**.
- 2 If necessary, select **Search Spacing**, and select a distance.
- 3 Select **Engage Port** or **Engage Starboard**.

## Cancelling a Steering Pattern

- Physically steer the boat.  
**NOTE:** Shadow Drive must be enabled to cancel a steering pattern by physically steering the boat.
- Select ◀ or ▶ to cancel a pattern using step steering mode.
- Select **Standby**.

# Digital Selective Calling

## Networked Chartplotter and VHF Radio Functionality

If you have a NMEA 0183 VHF radio or a NMEA 2000 VHF radio connected to your chartplotter, these features are enabled.

- The chartplotter can transfer your GPS position to your radio. If your radio is capable, GPS position information is transmitted with DSC calls.
- The chartplotter can receive digital selective calling (DSC) distress and position information from the radio.
- The chartplotter can track the positions of vessels sending position reports.

If you have a Garmin NMEA 2000 VHF radio connected to your chartplotter, these features are also enabled.

- The chartplotter allows you to quickly set up and send individual routine call details to your Garmin VHF radio.
- When you initiate a man-overboard distress call from your radio, the chartplotter shows the man-overboard screen and prompts you to navigate to the man-overboard point.
- When you initiate a man-overboard distress call from your chartplotter, the radio shows the Distress Call page to initiate a man-overboard distress call.

## Turning On DSC

Select **Settings > Other Vessels > DSC**.

## DSC List

The DSC list is a log of the most recent DSC calls and other DSC contacts you have entered. The DSC list can contain up to 100 entries. The DSC list shows the most recent call from a boat. If a second call is received from the same boat, it replaces the first call in the call list.

## Viewing the DSC List

Before you can view the DSC list, the chartplotter must be connected to a VHF radio that supports DSC.

Select **NAV INFO > DSC List**.

## Adding a DSC Contact

You can add a vessel to your DSC list. You can make calls to a DSC contact from the chartplotter.

- 1 Select **NAV INFO > DSC List > Add Contact**.
- 2 Enter the Maritime Mobile Service Identity (MMSI) of the vessel.
- 3 Enter the name of the vessel.

## Incoming Distress Calls

If your compatible chartplotter and VHF radio are connected using NMEA 0183 or NMEA 2000, your chartplotter alerts you when your VHF radio receives a DSC distress call. If position information was sent with the distress call, that information is also available and recorded with the call.

■ designates a distress call in the DSC list and marks the position of the vessel on the Navigation chart at the time of the DSC distress call.

## Navigating to a Vessel in Distress

■ designates a distress call in the DSC list and marks the position of a vessel on the Navigation chart at the time of the DSC distress call.

- 1 Select **NAV INFO > DSC List**.
- 2 Select a position-report call.
- 3 Select **Review > Navigate To**.
- 4 Select **Go To** or **Route To**.

## Man-Overboard Distress Calls Initiated from a VHF Radio

When the chartplotter is connected to a compatible VHF radio with NMEA 2000, and you initiate a man-overboard DSC distress call from the radio, the chartplotter shows the man-overboard screen and prompts you to navigate to the man-overboard point. If you have a compatible autopilot system connected to the network, the chartplotter prompts you to start a Williamson's turn to the man-overboard point.

If you cancel the man-overboard distress call on the radio, the chartplotter screen prompting you to activate navigation to the man-overboard location disappears.

## Man-Overboard and SOS Distress Calls Initiated from the Chartplotter

When your chartplotter is connected to a Garmin NMEA 2000 compatible radio and you mark an SOS or man-overboard location, the radio shows the Distress Call page so you can quickly initiate a distress call.

For information on placing distress calls from your radio, see the VHF radio owner's manual. For information about marking an MOB or SOS location, see [Marking an SOS Location, page 14](#).

## Position Tracking

When you connect the chartplotter to a VHF radio using NMEA 0183, you can track vessels that send position reports.

This feature is also available with NMEA 2000, when the vessel sends the correct PGN data (PGN 129808; DSC Call Information).

Every position report call received is logged in the DSC list ([DSC List, page 35](#)).

### Viewing a Position Report

- 1 Select **NAV INFO > DSC List**.
- 2 Select a position-report call.
- 3 Select **Review**.
- 4 Select an option:
  - To switch to a Navigation chart marking the location, select **Next Page**.
  - To view the position report details, select **Previous Page**.

### Navigating to a Tracked Vessel

- 1 Select **NAV INFO > DSC List**.
- 2 Select a position-report call.
- 3 Select **Review > Navigate To**.
- 4 Select **Go To** or **Route To**.

### Creating a Waypoint at the Position of a Tracked Vessel

- 1 Select **NAV INFO > DSC List**.
- 2 Select a position-report call.
- 3 Select **Review > Create Waypoint**.

### Editing Information in a Position Report

- 1 Select **NAV INFO > DSC List**.
- 2 Select a position-report call.
- 3 Select **Review > Edit**.
  - To enter the name of the vessel, select **Name**.
  - To select a new symbol, select **Symbol**, if available.
  - To enter a comment, select **Comment**.
  - To show a trail line for the vessel if your radio is tracking the position of the vessel, select **Trail**.
  - To select a color for the trail line, select **Trail Line**.

## Deleting a Position-Report Call

- 1 Select **NAV INFO > DSC List**.
- 2 Select a position-report call.
- 3 Select **Review > Clear Report**.

## Viewing Vessel Trails on the Chart

You can view trails for all tracked vessels on some chart views. By default, a black line indicates the path of the vessel, a black dot indicates each previously reported position of a tracked vessel, and a blue flag indicates the last reported position of the vessel.

- 1 From a chart or 3D chart view, select **MENU > Layers > Other Vessels > DSC > DSC Trails**.
- 2 Select the number of hours to show tracked vessels on the chart.

For example, if you select 4 Hours, all trail points that are less than four hours old appear for all tracked vessels.

## Individual Routine Calls

When you connect the chartplotter to a Garmin VHF radio, you can use the chartplotter interface to set up an individual routine call.

When setting up an individual routine call from your chartplotter, you can select the DSC channel on which you want to communicate. The radio transmits this request with your call.

### Selecting a DSC Channel

**NOTE:** The selection of a DSC channel is limited to those channels that are available in all frequency bands. The default channel is 72. If you select a different channel, the chartplotter uses that channel for subsequent calls until you call using another channel.

- 1 Select **NAV INFO > DSC List**.
- 2 Select a vessel or a station to call.
- 3 Select **Review > Call with Radio > Channel**.
- 4 Select an available channel.

### Making an Individual Routine Call

**NOTE:** When initiating a call from the chartplotter, if the radio does not have an MMSI number programmed, the radio will not receive call information.

- 1 Select **NAV INFO > DSC List**.
- 2 Select a vessel or a station to call.
- 3 Select **Review > Call with Radio**.
- 4 If necessary, select **Channel**, and select a new channel.
- 5 Select **Send**.

The chartplotter sends information about the call to the radio.

- 6 On your Garmin VHF radio, select **Call**.

### Making an Individual Routine Call to an AIS Target

- 1 From a chart or 3D chart view, select an AIS target.
- 2 Select **AIS Vessel > Call with Radio**.
- 3 If necessary, select **Channel**, and select a new channel.
- 4 Select **Send**.

The chartplotter sends information about the call to the radio.

- 5 On your Garmin VHF radio, select **Call**.

## Gauges and Graphs

The gauges and graphs provide various information about the engine and environment. To view the information, a compatible transducer or sensor must be connected to the network.

## Viewing the Gauges

- 1 Select **A/V, Gauges, Controls**.
- 2 Select a gauge.
- 3 Select ◀ or ▶ to view a different gauge page.

### Changing the Data Shown in a Gauge

- 1 From a gauges screen, hold a gauge.
- 2 Select **Replace Data**.
- 3 Select a data type.
- 4 Select the data to display.

### Customizing the Gauges

You can change the layout of the gauge pages, how the gauges pages are displayed, and the data in each gauge.

- 1 Open a gauge page.
- 2 Select **MENU > Edit Gauge Pages**.
- 3 Select an option:
  - To change the data shown in a gauge, select the gauge.
  - To change the layout of the gauges on the page, select **Change Layout**.
  - To add a page to this set of gauge pages, select **Add Page**.
  - To change the order of this page in the set of gauge pages, select **Move Page Left** or **Move Page Right**.
  - To restore this page to the original view, select **Restore Default View**.

### Customizing Engine Gauge and Fuel Gauge Limits

You can configure the upper and lower limits and the range of desired standard operation of a gauge.

**NOTE:** Not all options are available for all gauges.

- 1 From an applicable gauges screen, select **MENU > Installation > Set Gauge Limits**.
- 2 Select a gauge to customize.
- 3 Select an option:
  - To set the minimum value of the standard operating range, select **Rated Min..**
  - To set the maximum value of the standard operating range, select **Rated Max..**
  - To set the lower limit of the gauge lower than the rated minimum, select **Scale Min..**
  - To set the upper limit of the gauge higher than the rated maximum, select **Scale Max..**
- 4 Select the limit value.
- 5 Repeat steps 4 and 5 to set additional gauge limits.

## Viewing Engine and Fuel Gauges

Before you can view engine and fuel gauges, you must be connected to a NMEA 2000 network capable of sensing engine and fuel data. See the installation instructions for details.

Select **A/V, Gauges, Controls > Engines**.

### Selecting the Number of Engines Shown in Gauges

You can show information for up to four engines.

- 1 From the engine gauges screen, select **MENU > Installation > Engine Selection > Number of Engines**.
- 2 Select an option:
  - Select the number of engines.
  - Select **Auto Configure** to automatically detect the number of engines.

### Customizing the Engines Shown in Gauges

Before you can customize how the engines are shown in the gauges, you must manually select the number of engines (*Selecting the Number of Engines Shown in Gauges, page 37*).

- 1 From the engine gauges screen, select **MENU > Installation > Engine Selection > Edit Engines**.
- 2 Select **First Engine**.
- 3 Select the engine to display in the first gauge.
- 4 Repeat for the remaining engine bars.

### Enabling Status Alarms for Engine Gauges

You can enable the chartplotter to display engine status alarms.

From the engine gauges screen, select **MENU > Installation > Status Alarms > On**.

When an engine alarm is triggered, a gauge status alarm message appears and the gauge may become red depending on the type of alarm.

### Enabling Some Engine Gauge Status Alarms

- 1 From the engine gauges screen, select **MENU > Installation > Status Alarms > Custom**.
- 2 Select one or more engine gauge alarms to turn on or off.

## Setting the Fuel Alarm

Before you can set a fuel level alarm, a compatible fuel flow sensor must be connected to the chartplotter.

You can set an alarm to sound when the total amount of remaining onboard fuel reaches the level you specify.

- 1 Select **Settings > Alarms > Fuel > Set Total Fuel Onboard > On**.
- 2 Enter the remaining amount of fuel that triggers the alarm, and select **Done**.

### Setting the Fuel Capacity of the Vessel

- 1 Select **Settings > My Vessel > Fuel Capacity**.
- 2 Enter the combined total capacity of the fuel tanks.

### Synchronizing the Fuel Data with the Actual Vessel Fuel

You can synchronize the fuel levels in the chartplotter with the actual fuel in the vessel when you add fuel to your vessel.

- 1 Select **A/V, Gauges, Controls > Engines > MENU**.
- 2 Select an option:
  - After you have filled up all the fuel tanks on the vessel, select **Fill Up All Tanks**. The fuel level is reset to maximum capacity.
  - After you have added less than a full tank of fuel, select **Add Fuel to Boat**, and enter the amount added.
  - To specify the total fuel in the vessel tanks, select **Set Total Fuel Onboard**, and enter the total amount of fuel in the tanks.

## Viewing the Wind Gauges

Before you can view wind information, you must have a wind sensor connected to the chartplotter.

Select **A/V, Gauges, Controls > Wind**.

### Configuring the Sailing Wind Gauge

You can configure the sailing wind gauge to show true or apparent wind speed and angle.

- 1 From the wind gauge, select **MENU > Sailing Wind Gauge**.
- 2 Select an option:
  - To show true or apparent wind angle, select **Needle**, and select an option.

- To show true or apparent wind speed, select **Wind Speed**, and select an option.

### Configuring the Speed Source

You can specify whether the vessel speed data displayed on the gauge and used for wind calculations is based on water speed or GPS speed.

- 1 From the wind gauge, select **MENU > Compass Gauge > Speed Display**.
- 2 Select an option:
  - To calculate the vessel speed based on data from the water-speed sensor, select **Water Speed**.
  - To calculate the vessel speed based on GPS data, select **GPS Speed**.

### Configuring the Heading Source of the Wind Gauge

You can specify the source of the heading displayed on the wind gauge. Magnetic heading is the heading data received from a heading sensor, and GPS heading is calculated by your chartplotter GPS (course over ground).

- 1 From the wind gauge, select **MENU > Compass Gauge > Heading Source**.
- 2 Select **GPS Hdg.** or **Magnetic**.
 

**NOTE:** When moving at low speeds or when stationary, the magnetic compass source is more accurate than the GPS source.

### Customizing the Close-Hauled Wind Gauge

You can specify the range of the close-hauled wind gauge for both the upwind scale and the downwind scale.

- 1 From the wind gauge, select **MENU > Compass Gauge > Gauge Type > Close Hauled Gauge**.
- 2 Select an option:
  - To set the maximum and minimum values that appear when the upwind close-hauled wind gauge appears, select **Change Upwind Scale**, and set the angles.
  - To set the maximum and minimum values that appear when the downwind close-hauled wind gauge appears, select **Change Downwind Scale**, and set the angles.
  - To view true or apparent wind, select **Wind**, and select an option.

### Viewing Trip Gauges

Trip gauges show information for odometer, speed, time, and fuel for your present trip.

Select **NAV INFO > Trip & Graphs > Trip**.

#### Resetting Trip Gauges

- 1 Select **NAV INFO > Trip & Graphs > Trip**.
- 2 Select an option:
  - To set all the readings for the present trip to zero, select **Reset Trip**.
  - To set the maximum speed reading to zero, select **Reset Maximum Speed**.
  - To set the odometer reading to zero, select **Reset Odometer**.
  - To set all the readings to zero, select **Reset All**.

### Viewing Graphs

Before you can view graphs of various environmental changes, such as temperature, depth, and wind, you must have an appropriate transducer or sensor connected to the network.

Select **NAV INFO > Trip & Graphs > Graphs**.

### Setting the Graph Range and Time Scales

You can indicate the amount of time and the range of depth that appear in the depth and water temperature graphs.

- 1 From a graph, select **Graph Setup**.
- 2 Select an option:
  - To set a time-elapsed scale, select **Duration**. The default setting is 10 minutes. Increasing the time-elapsed scale allows you to view variations over a longer period of time. Decreasing the time-elapsed scale allows you to view more detail over a shorter period of time.
  - To set the graph scale, select **Scale**. Increasing the scale allows you to view more variation in readings. Decreasing the scale allows you to view more detail in the variation.

### Battery Management

You can view the battery and other power sources, and the devices that use those sources.

Batteries are listed along the top of the screen. Other sources of power, such as solar, alternator, converter, and wind generator, are listed along the left side. The items along the right side of the screen are devices that use the batteries and other power sources.

#### Setting Up the Battery Management Page

- 1 Select **A/V, Gauges, Controls > Battery Management > MENU > Edit Devices**.
- 2 Select an item.
- 3 Select **Device**, and select an item from the list.
- 4 If necessary, select **Name**, enter a name for this device, and select **Done**.
- 5 If necessary, select **Change Icon**, select a new symbol, and select **Done**.
- 6 Repeat steps 2 through 5 for each device.

## Tide, Current, and Celestial Information

### Tide Station Information

You can view information about a tide station for a specific date and time, including the tide height, and when the next high and low tides will occur. By default, the chartplotter shows tide information for the most recently viewed tide station, present date, and past hour.

Select **NAV INFO > Tides & Currents > Tides**.

### Current Station Information

**NOTE:** Current station information is available with certain detailed maps.

You can view information about a current station for a specific date and time, including the current speed and level of the current. By default, the chartplotter shows current information for the most recently viewed current station and for the present date and time.

Select **NAV INFO > Tides & Currents > Currents**.

### Celestial Information

You can view information about sunrise, sunset, moonrise, moonset, moon phase, and the approximate sky view location of the sun and moon. The center of the screen represents the sky overhead, and the outermost rings represent the horizon. By default, the chartplotter shows celestial information for the present date and time.

Select **NAV INFO > Tides & Currents > Celestial**.

## Viewing Tide Station, Current Station, or Celestial Information for a Different Date

- 1 Select **NAV INFO > Tides & Currents**.
- 2 Select **Tides, Currents, or Celestial**.
- 3 Select an option.
  - To view information for a different date, select **Change Date > Manual**, and enter a date.
  - To view information for today, select **Change Date > Current**.
  - If available, to view information for the day after the date shown, select **Next Day**.
  - If available, to view information for the day before the date shown, select **Previous Day**.

## Viewing Information for a Different Tide or Current Station

- 1 Select **NAV INFO > Tides & Currents**.
- 2 Select **Tides** or **Currents**.
- 3 Select **Nearby Stations**.
- 4 Select a station.

## Viewing Almanac Information from the Navigation Chart

- 1 From a chart or 3D chart view, select a location.
- 2 Select **Information**.
- 3 Select **Tides, Currents, or Celestial**.

## Warning Manager

### Viewing Messages

- 1 Select **NAV INFO > Warning Manager**.
- 2 Select a message.
- 3 Select **Review**.

### Sorting and Filtering Messages

- 1 Select **NAV INFO > Warning Manager > Sort/Filter**.
- 2 Select an option to sort or filter the message list.

### Saving Messages to a Memory Card

- 1 Insert a memory card into the card slot.
- 2 Select **NAV INFO > Warning Manager > Save to Card**.

### Clearing all of the Messages

Select **NAV INFO > Warning Manager > Clear Warning Manager**.

## Media Player

**NOTE:** The media player feature is not compatible with all chartplotter models.

**NOTE:** Not all features are available on all connected media players.

If you have a compatible stereo connected to the NMEA 2000 network, you can control the stereo using the chartplotter. The chartplotter should automatically detect the media player when it is first connected.

You can play media from sources connected to the media player and sources connected to the NMEA 2000 network.

## Opening the Media Player

Before you can open the media player, you must connect a compatible device to the chartplotter.

Select **A/V, Gauges, Controls > Media**.

### Icons

**NOTE:** Not all devices have these icons.

Icon	Description
★	Saves or deletes a channel as a preset
↺	Repeats all songs
↺ <sup>1</sup>	Repeats one song
⏮⏭⏭⏭⏮	Searches for stations or skips songs
↻	Shuffles

## Selecting the Media Source

When you have multiple media devices connected on a network, such as the NMEA 2000 network, you can select the media source you want to control from your chartplotter.

**NOTE:** You can play media only from sources that are connected to the device.

**NOTE:** Not all features are available on all media sources.

- 1 From the media screen, select **Source**.

**NOTE:** The source menu appears only for devices that support multiple media sources.

- 2 Select a source.

## Playing Music

### Browsing for Music

- 1 From the media screen, select **Browse** or **MENU > Browse**.
- 2 Select **SELECT** or select an option.

### Enabling Alphabetical Search

You can enable the alphabetical search feature to find a song or album in a large list.

From the media screen, select **MENU > Installation > Alpha Search**.

### Setting a Song to Repeat

- 1 While playing a song, select **MENU > Repeat**.
- 2 If necessary, select **Single**.

### Setting All Songs to Repeat

From the media screen, select **MENU > Repeat > All**.

### Setting Songs to Shuffle

- 1 From the media screen, select **MENU > Shuffle**.
- 2 If necessary, select an option.

## Adjusting the Volume

### Muting the Media Volume

- 1 From the media screen, select **⏸**.
- 2 If necessary, select **SELECT**.

### Enabling and Disabling Zones

If you have wired your vessel's speakers into zones, you can disable unused zones.

- 1 From the media screen, select **MENU > Audio Levels > Enable/Disable Zones**.
- 2 Select a zone.

## VHF Radio

### Scanning VHF Channels

Before you can scan VHF channels, you must set the source to VHF.

You can monitor VHF channels saved as presets for activity and automatically switch to an active channel.

From the VHF media screen, select **Scan**.

### Adjusting the VHF Squelch

**NOTE:** Your media player must support VHF radio to use this feature.

- 1 From the VHF source page, select **MENU > Squelch**.
- 2 Use the slider bar to adjust the VHF squelch.

## Radio

To listen to AM or FM radio, you must have a suitable marine AM/FM antenna properly connected to the stereo and be within range of a broadcasting station. For instructions on connecting an AM/FM antenna, see the stereo installation instructions.

To listen to SiriusXM® radio, you must have the appropriate equipment and subscriptions (*SiriusXM Satellite Radio*, page 41). For instructions on connecting a SiriusXM Connect Vehicle Tuner, see the stereo installation instructions.

To listen to DAB stations, you must have the appropriate equipment (*DAB Playback*, page 40). For instructions on connecting a DAB adapter and antenna, see the installation instructions provided with your adapter and antenna.

### Setting the Tuner Region

- 1 From the media screen, select **MENU > Installation > Tuner Region**.
- 2 Select an option.

### Changing the Radio Station

- 1 From the media screen, select an applicable source, such as **FM**.
- 2 Select **◀** or **▶** to tune to a station.

### Changing the Tuning Mode

You can change how you select a station for some media types, such as FM or AM radio.

**NOTE:** Not all tuning modes are available for all media sources.

- 1 From the media screen, select **MENU > Tuning Mode**.
- 2 Select an option.
- 3 If necessary, select **SELECT**.

## Presets

You can save your favorite AM stations and FM stations as presets for easy access.

You can save your favorite SiriusXM channels if you are connected to an optional SiriusXM tuner and antenna.

### Saving a Station as a Preset

- 1 From an applicable media screen, tune to the station to save as a preset.
- 2 Select **Presets > Add Current Channel**.

### Selecting a Preset

- 1 From an applicable media screen, select **Presets**.
- 2 Select a preset from the list.
- 3 Select **Tune to Channel**.

### Removing a Preset

- 1 From an applicable media screen, select **Presets**.
- 2 Select a preset from the list.
- 3 Select **Remove Current Channel**.

## DAB Playback

When you connect a compatible Digital Audio Broadcasting (DAB) module and antenna, such as the FUSION® MS-DAB100A to a compatible stereo, you can tune in to and play DAB stations

To use the DAB source, you must be in a region in which DAB is available, and select the tuner region (*Setting the DAB Tuner Region*, page 40).

### Setting the DAB Tuner Region

You must select the region you are in to receive DAB stations properly.

- 1 From the media screen, select **MENU > Installation > Tuner Region**.
- 2 Select the region you are in.

### Scanning for DAB Stations

Before you can scan for DAB stations, you must connect a compatible DAB module and antenna (not included) to the stereo. Because DAB signals are broadcast in select countries only, you must also set the tuner region to a location where DAB signals are broadcast.

- 1 Select the **DAB** source.
- 2 Select **Scan** to scan for available DAB stations.

When scanning is complete, the first available station in the first ensemble found begins playing.

**NOTE:** After the first scan is complete, you can select **Scan** again to re-scan for DAB stations. When the re-scan is complete, the system starts playing the first station in the ensemble you were listening to when you started the re-scan.

### Changing DAB Stations

- 1 Select the **DAB** source.
- 2 If necessary, select **Scan** to scan for local DAB stations.
- 3 Select **◀** or **▶** to change the station.

When you reach the end of the current ensemble, the stereo automatically changes to the first available station in the next ensemble.

### Selecting a DAB Station from a List

- 1 From the DAB media screen, select **Browse > Stations**.
- 2 Select a station from the list.

### Selecting a DAB Station from a Category

- 1 From the DAB media screen, select **Browse > Categories**.
- 2 Select a category from the list.
- 3 Select a station from the list.

## DAB Presets

You can save your favorite DAB stations as presets for easy access.

You can save up to 15 DAB-station presets.

### Saving a DAB Station as a Preset

- 1 From the DAB media screen, select the station to save as a preset.
- 2 Select **Browse > Presets > Save Current**.

### Selecting a DAB Preset from a List

- 1 From the DAB media screen, select **Browse > Presets > View Presets**.
- 2 Select a preset from the list.

### Removing DAB Presets

- 1 From the DAB media screen, select **Browse > Presets**.
- 2 Select an option:
  - To remove one preset, select **Remove Preset**, and select the preset.



- To remove all presets, select **Remove All Presets**.

## SiriusXM Satellite Radio

When you have a FUSION-Link™ capable stereo and SiriusXM Connect Tuner installed and connected to the chartplotter, you may have access to SiriusXM satellite radio, depending on your subscription.

### Locating a SiriusXM Radio ID

Before you can activate your SiriusXM subscription, you must have the radio ID of your SiriusXM Connect Tuner.

You can locate the SiriusXM Radio ID on the back of the SiriusXM Connect Tuner, on the back of its packaging, or by tuning your chartplotter to channel 0.

- 1 Select **Media > Source > SiriusXM**.
- 2 Tune to channel 0.

The SiriusXM radio ID does not include the letters I, O, S, or F.

### Activating a SiriusXM Subscription

- 1 With the SiriusXM source selected, tune to channel 1.  
You should be able to hear the preview channel. If not, check the SiriusXM Connect Tuner and antenna installation and connections, and try again.
- 2 Tune to channel 0 to locate the Radio ID.
- 3 Contact SiriusXM listener care by phone at (866) 635-2349 or go to [www.siriusxm.com/activatenow](http://www.siriusxm.com/activatenow) to subscribe in the United States. Contact SiriusXM by phone at (877) 438-9677 or go to [www.siriusxm.ca/activatexm](http://www.siriusxm.ca/activatexm) to subscribe in Canada.
- 4 Provide the Radio ID.  
The activation process usually takes 10 to 15 minutes, but can take up to an hour. For the SiriusXM Connect Tuner to receive the activation message, it must be turned on and receiving the SiriusXM signal.
- 5 If the service is not activated within the hour, go to <http://care.siriusxm.com/refresh> or contact SiriusXM by phone at 1-855-MYREFRESH (697-3373).

### Customizing the Channel Guide

SiriusXM radio channels are grouped in categories. You can select the categories of channels that appear in the channel guide.

Select an option:

- If the media device is a FUSION-Link capable stereo, select **Media > Browse > Channel**.
- If the media device is a GXM™ antenna, select **Media > Category**.

### Saving a SiriusXM Channel to the Presets List

You can save your favorite channels to the presets list.

- 1 Select **Media**.
- 2 Select the channel to save as a preset.
- 3 Select an option:
  - If the media device is a FUSION-Link capable stereo, select **Browse > Presets**.
  - If the media device is a GXM antenna, select **MENU > Presets > Add Current Channel**.

### Unlocking SiriusXM Parental Controls

- 1 From the media screen, select **Browse > Parental > Unlock**.
- 2 Enter your passcode.  
The default passcode is 0000.

### Setting Parental Controls on SiriusXM Radio Channels



Before you can set parental controls, the parental controls must be unlocked.

The parental control feature allows you to limit access to any SiriusXM channels, including those with mature content. When enabled, the parental control feature requires you to enter a passcode to tune to the locked channels.

Select **Browse > Parental > Lock/Unlock**.

A list of channels appears. A checkmark indicates a locked channel.

**NOTE:** When you view the channels after setting parental controls, the display changes:

-  indicates a locked channel.
-  indicates an unlocked channel.

### Changing a Parental Passcode on a SiriusXM Radio

Before you can change the passcode, the parental controls must be unlocked.

- 1 From the media screen, select **Browse > Parental > Change PIN**.
- 2 Enter your passcode and select **Done**.
- 3 Enter a new passcode.
- 4 Confirm the new passcode.

### Restoring Default Parental Control Settings Values

This process deletes all the settings information you have entered. When you restore the parental control settings to their default values, the passcode value is reset to 0000.

- 1 From the media menu, select **Installation > Factory Defaults**.
- 2 Select **Yes**.

### Clearing All Locked Channels on a SiriusXM Radio

Before you can clear all locked channels, the parental controls must be unlocked.

- 1 From the media screen, select **Browse > Parental > Clear All Locked**.
- 2 Enter your passcode.

## Setting the Device Name

- 1 From the media screen, select **MENU > Installation > Set Device Name**.
- 2 Enter a device name.
- 3 Select **SELECT** or **Done**.

## Updating the Media Player Software

You can update the software on compatible connected stereos and accessories.

- 1 Go to [www.fusionentertainment.com/marine](http://www.fusionentertainment.com/marine), and download the software update onto a USB flash drive.  
Software updates and instructions are available on your device product page.
- 2 Insert the USB flash drive into the USB port of the stereo.
- 3 On the chartplotter media screen, select **MENU > Installation > Update Software**.
- 4 Select the item to update.

## SiriusXM Weather

### WARNING

The weather information provided through this product is subject to service interruptions and may contain errors, inaccuracies, or outdated information, and consequently should not be relied upon exclusively. Always use common sense while navigating, and check alternate weather information sources prior to making safety-related decisions. You acknowledge and agree that you shall be solely responsible for use of the weather information and all decisions taken with respect to navigating in weather.

Garmin will not be responsible for any consequences of using SiriusXM weather information.

**NOTE:** SiriusXM data is not available in all regions.

A Garmin SiriusXM satellite weather receiver and antenna receives satellite weather data and shows it on various Garmin devices, including the Navigation chart on a compatible chartplotter. The weather data for each feature comes from reputable weather data centers such as the National Weather Service and the Hydrometeorological Prediction Center. For more information, go to [www.siriusxm.com/sxmmarine](http://www.siriusxm.com/sxmmarine).

## SiriusXM Equipment and Subscription Requirements

To use satellite weather, you must have a compatible satellite weather receiver. To use SiriusXM satellite radio, you must have a compatible satellite radio receiver. Go to [www.garmin.com](http://www.garmin.com) for more information. You must also have a valid subscription to receive satellite weather and radio. For more information, refer to the instructions for your satellite weather and radio equipment.

## Weather Data Broadcasts

Weather data is broadcast at different intervals for each weather feature. For example, radar is broadcast at five-minute intervals. When the Garmin receiver is turned on, or when a different weather feature is selected, the receiver must receive new data before it can be shown. You might experience a delay before weather data or a different feature appears on the chart.

**NOTE:** Any weather feature can change in appearance if the source that provides the information changes.

## Changing the Weather Chart

- 1 From a combination screen or SmartMode layout with a weather chart, select **MENU > Weather Menu > Change Weather**.
- 2 Select a weather chart.

## Viewing Precipitation Information

Precipitation ranging from very light rain and snow, up to strong thunderstorms, is indicated in varying shades and colors. Precipitation is shown either independently or with other weather information.

Select **Charts > Precipitation**.

The time stamp in the upper-left corner of the screen indicates the elapsed time since the weather data provider last updated the information.

### Precipitation Views

From the precipitation weather chart, select **MENU**.

**RADAR Loop:** Shows precipitation information as an image of the latest update or as an animated loop of the latest updates. The time stamp indicates the elapsed time since the service provider generated the weather radar frame currently displayed on the screen.

**Cloud Cover:** Shows cloud cover data.

**Waypoints:** Shows waypoints.

**Legend:** Shows the weather legend.

## Storm Cell and Lightning Information

Storm cells are represented by  on the weather precipitation chart. They indicate both the present position of a storm and the projected path of that storm in the immediate future.

Red cones appear with a storm cell icon, and the widest part of each cone points in the direction of the projected path of the storm cell. The red lines in each cone indicate where the storm

will most likely be in the near future. Each line represents 15 minutes.

Lightning strikes are represented by . Lightning appears on the weather precipitation chart if strikes were detected within the last seven minutes. The ground-based lightning detection network detects cloud-to-ground lightning only.

**NOTE:** This feature is not available on all devices and in all subscriptions.

## Hurricane Information

The weather Precipitation chart can show the present position of a hurricane , a tropical storm, or a tropical depression. A red line stemming from a hurricane icon indicates the projected path of the hurricane. Darkened dots on the red line indicate the projected locations through which the hurricane will pass, as received from the weather data provider.

## Weather Warnings and Weather Bulletins

When a marine weather warning, weather watch, weather advisory, weather bulletin, or other weather statement is issued, shading indicates the area to which the information applies. The aqua lines on the chart indicate the boundaries of marine forecasts, coastal forecasts, and offshore forecasts. Weather bulletins may consist of either weather watches or weather advisories.

To view information about the warning or bulletin, select the shaded area.

Color	Marine Weather Group
Cyan	Flash Flood
Blue	Flood
Red	Marine
Yellow	Severe Storm
Red	Tornado

## Forecast Information





The Forecast chart shows city forecasts, marine forecasts, warnings, hurricane warnings, METARS, county warnings, weather fronts and pressure centers, surface pressure, and weather buoys.

### Viewing Forecast Information for Another Time Period

- 1 Select **Charts > Forecast**.
- 2 Select an option:
  - To view the weather forecast for the next 48 hours, in 12-hour increments, select **Next Forecast** multiple times.
  - To view the weather forecast for the previous 48 hours, in 12-hour increments, select **Previous Forecast** multiple times.

## Weather Fronts and Pressure Centers

Weather fronts appear as lines that indicate the leading edge of an air mass.

Front Symbol	Description
	Cold front
	Warm front
	Stationary front
	Occluded front
	Trough

Pressure-center symbols often appear near weather fronts.

Pressure-Center Symbol	Description
<b>L</b>	Indicates a low-pressure center, which is a region of relatively lower pressure. Moving away from a low-pressure center results in increased pressure. Winds flow counterclockwise around low-pressure centers in the northern hemisphere.
<b>H</b>	Indicates a high-pressure center, which is a region of relatively higher pressure. Moving away from a high-pressure center results in decreased pressure. Winds flow clockwise around high-pressure centers in the northern hemisphere.

## Viewing a Marine Forecast or an Offshore Forecast

1 Select **Charts > Forecast**.









2 Pan the chart to an offshore location.

The Marine Forecast or Offshore Forecast options appear when forecast information is available.

3 Select **Marine Forecast** or **Offshore Forecast**.

## City Forecasts

City forecasts appear as weather symbols. The forecast is viewed in 12-hour increments.

Symbol	Weather	Symbol	Weather
	Partly cloudy		Fair (sunny, hot, clear)
	Cloudy		Rain (drizzle, sleet, showers)
	Windy		Foggy
	Thunderstorms		Snow (snow showers, flurries, blizzard, blowing snow, sleet, freezing rain, freezing drizzle)
	Smoke (dusty, hazy)		







## Viewing Sea Conditions

The Sea Conditions feature shows information about surface conditions, including winds, wave height, wave period, and wave direction.

Select **Charts > Sea Conditions**.

### Surface Winds

Surface wind vectors appear on the Sea Conditions chart using wind barbs that indicate the direction from which the wind is blowing. A wind barb is a circle with a tail. The line or flag attached to the tail of the wind barb indicates the wind speed. A short line represents 5 knots, a long line represents 10 knots, and triangle represents 50 knots.

Wind Barb	Wind Speed	Wind Barb	Wind Speed
	Calm		20 knots
	5 knots		50 knots
	10 knots		65 knots
	15 knots		

### Wave Height, Wave Period, and Wave Direction

Wave heights for an area appear as variations in color. Different colors indicate different wave heights, as shown in the legend.

The wave period indicates the time (in seconds) between successive waves. Wave period lines indicate areas that have the same wave period.

Wave directions appear on the chart using red arrows. The direction of each arrow pointer indicates the direction in which a wave is moving.

## Viewing Forecast Sea Conditions Information for Another Time Period

1 Select **Charts > Sea Conditions**.

2 Select an option:

- To view forecasted sea conditions for the next 36 hours, in 12-hour increments, select **Next Forecast** multiple times.
- To view the forecasted sea conditions for the previous 36 hours, in 12-hour increments, select **Previous Forecast** multiple times.

## Viewing Fishing Information

The weather Fishing chart shows present water temperature, present surface pressure conditions, and fishing forecasts.

Select **Charts > Fishing**.

### Surface Pressure and Water Temperature Data

Surface-pressure information appears as pressure isobars and pressure centers. Isobars connect points of equal pressure. Pressure readings can help to determine weather and wind conditions. High-pressure areas are generally associated with fair weather. Low-pressure areas are generally associated with clouds and the chance of precipitation. Isobars packed closely together show a strong pressure gradient. Strong pressure gradients are associated with areas of stronger winds.

Pressure units are shown in millibars (mb), inches of Mercury (inHg), or hectopascals (hPa).

Colored shading indicates the surface temperature of the water, as shown in the legend in the corner of the display.

### Forecasting Fish Locations

You can show areas that contain optimal weather conditions for specific species of fish.

**NOTE:** This feature is not available on all devices and in all subscriptions.

1 From the weather Fishing chart, select **MENU > Fish Species**.

2 Select a species of fish.

3 Select **On**.

4 Repeat steps 2 and 3 to show areas with optimal weather conditions for additional species of fish.

Shaded areas indicate optimal fishing areas. If you have selected more than one species of fish, you can select a shaded area to view the fish species that are included in the shaded area.

### Changing the Sea Surface Temperature Color Range

You can change the color range dynamically to view higher resolution sea surface temperature readings.

1 From the weather fishing chart, select **MENU > Sea Temperature**.

2 Select an option:

- To allow the chartplotter to adjust the temperature range automatically, select **Auto Configure**.

The chartplotter automatically finds the lower and upper limits for the current screen, and updates the temperature-color scale.

- To enter the lower and upper limits for the temperature range, select **Lower Limit** or **Upper Limit**, and enter the lower or upper limit.

## Visibility Information

Visibility is the forecast maximum horizontal distance that can be seen at the surface, as shown in the legend on the left of the screen. Variations in the visibility shading show the forecast change in surface visibility.

**NOTE:** This feature is not available on all devices and in all subscriptions.

Select **Charts > Visibility**.

### Viewing Forecast Visibility Information for Another Time Period

- 1 Select **Charts > Visibility**.
- 2 Select an option:
  - To view the visibility forecast for the next 36 hours, in 12-hour increments, select **Next Forecast** multiple times.
  - To view the visibility forecast for the previous 36 hours, in 12-hour increments, select **Previous Forecast** multiple times.

### Viewing Buoy Reports

Report readings are taken from buoys and coastal observation stations. These readings are used to determine air temperature, dew point, water temperature, tide, wave height and period, wind direction and speed, visibility, and barometric pressure.

- 1 From a weather chart, select .
- 2 Select **Buoy**.

### Viewing Local Weather Information near a Buoy

You can select an area near a buoy to view forecast information.

- 1 From a weather chart, select a location on the chart.
- 2 Select **Local Weather**.
- 3 Select an option:
  - To view present weather conditions from a local weather service, select **Current Cond.**
  - To view a local weather forecast, select **Forecast**.
  - To view surface wind and barometric pressure information, select **Sea Surface**.
  - To view wind and wave information, select **Marine Bulletin**.

### Weather Overlay

The weather overlay superimposes weather and weather-related information on the Navigation chart, the Fishing chart, and the Perspective 3D chart view. The Navigation chart and the Fishing chart can show weather radar, height of cloud tops, lightning, weather buoys, county warnings, and hurricane warnings. The Perspective 3D chart view can show weather radar.

Weather overlay settings configured for use on one chart are not applied to another chart. The weather overlay settings for each chart must be configured separately.

**NOTE:** The Fishing chart is available with premium charts, in some areas.

#### Turning On the Weather Overlay on a Chart

From the Navigation chart or Fishing chart, select **MENU > Layers > Weather > Weather > On**.

#### Weather Overlay Settings on the Navigation Chart

From the Navigation chart, select **MENU > Layers > Weather**.

**Weather:** Turns on and off the weather overlay.

**Precipitation:** Shows precipitation data.

**Cloud Cover:** Shows cloud cover data.

**Visibility:** Shows visibility data.

**Buoys:** Shows weather buoys.

**Legend:** Shows the weather legend.

#### Weather Overlay Settings on the Fishing Chart

From the Fishing chart, select **MENU > Layers > Weather**.

**Precipitation:** Shows precipitation radar.

**Sea Temperature:** Shows sea temperature data.

**Buoys:** Shows weather buoys.

**Legend:** Shows the weather legend.

### Viewing Weather Subscription Information

You can view information about the weather services you have subscribed to and how many minutes have passed since the data for each service was updated.

From a weather chart, select **MENU > Weather Subscription**.

## Viewing Video

Before you can view video, you must connect to a compatible source.

Compatible devices include video devices connected to the ports on the chartplotter or to the Garmin Marine Network, as well as supported network (IP-based) video cameras, encoders, and thermal cameras.

Select **A/V, Gauges, Controls > Video**.

### Selecting a Video Source

- 1 From the video screen, select **MENU > Source**.
- 2 Select the source of the video feed.

### Alternating Among Multiple Video Sources

If you have two or more video sources, you can alternate between them using a specific time interval.

- 1 From the video screen, select **MENU > Source > Alternate**.
- 2 Select **Time**, and select the amount of time each video appears.
- 3 Select **Source**, and select the video sources to add to the alternating sequence.

### Networked Video Devices

#### NOTICE

A Garmin Power over Ethernet (PoE) Isolation Coupler (P/N 010-10580-10) must be used when connecting a PoE device, such as a FLIR® camera, to a Garmin Marine Network. Connecting a PoE device directly to a Garmin Marine Network chartplotter damages the Garmin chartplotter and may damage the PoE device.

Before you can view and control video devices such as IP cameras, encoders, and thermal cameras using your chartplotter, you must have a compatible video device connected to your chartplotter, and you must have a marine network cable Power over Ethernet (PoE) isolation coupler. Go to [www.garmin.com](http://www.garmin.com) for a list of compatible devices or to purchase a PoE Isolation Coupler.

You can connect multiple supported video cameras and up to two video encoders to the Garmin Marine Network. You can select and view up to four video sources at once. Chartplotters with multiple composite built-in video inputs can display a single built-in video input only. When the cameras are connected, the network detects them automatically and displays them in the source list.

### Using Video Presets on Networked Video Cameras

You can save, name, and activate video presents for each networked video source.

#### Saving Video Presets on a Networked Video Camera

- 1 From a video screen, touch the screen.

The video controls appear on the screen.
- 2 Hold a video preset button.

A green light indicates the setting is stored.

### **Naming Video Presets on a Networked Video Camera**

- 1 From a video screen, select **MENU > Video Setup > Presets**.
- 2 Select a preset.
- 3 Select **Rename**.
- 4 Enter preset name.

### **Activating Video Presets on a Networked Video Camera**

You can quickly return networked cameras to preset values.

- 1 From a video screen, touch the screen.  
The video controls appear on the screen.
  - 2 Select a video preset.  
The camera restores the video settings saved for that preset.
- TIP:** You can also save and activate presets using the video menu.

### **Camera Settings**

Some cameras provide additional options to control the camera view.

**NOTE:** Not all options are available on all camera models and chartplotter models. Refer to the camera manual for a list of available features. You may need to update the camera software to use this feature.

From the infrared video screen, select **MENU**.

**IR/Visible:** Displays an infrared or visible camera image.

**Scan:** Surveys the surrounding area.

**Freeze:** Pauses the camera image.

**Change Colors:** Selects the color scheme of the infrared image.

**Change Scene:** Selects the infrared image mode, such as day, night, MOB, or docking.

**Video Setup:** Opens more video options.

### **Video Settings**

Some cameras provide additional setup options.

**NOTE:** Not all options are available on all camera models and chartplotter models. You may need to update the camera software to use this feature.

From the video screen, select **MENU > Video Setup**.

**Set Input:** Associates the camera with a video source.

**Mirror:** Reverses the image like a rearview mirror.

**Standby:** Places the camera in standby mode to conserve power and protect the lens when not in use.

**Home Position:** Sets the home position of the camera.

**Scan Speed:** Sets how quickly the camera moves during a scan.

**Scan Width:** Sets the width of the image captured by the camera during a scan.

**Name:** Allows you to enter a new name for this camera.

**FLIR™ Menu:** Provides access to the settings for the camera.

### **Associating the Camera to a Video Source**

You may need to associate the camera with a video source.

- 1 From the video screen, select **MENU > Source**.
- 2 Select the camera.
- 3 Select **Video Setup > Set Input**.
- 4 Select the video input.

### **Video Camera Movement Control**

#### **NOTICE**

Do not aim the camera at the sun or extremely bright objects. Damage to the lens may occur.

Always use the chartplotter controls or buttons to pan and tilt the camera. Do not manually move the camera unit. Manually moving the camera may damage the camera.

**NOTE:** This feature is available only when a compatible camera is connected. You may need to update the camera software to use this feature.

You can control the movements of the connected video cameras that support panning, tilting, and zooming.

### **Controlling Video Cameras Using On-Screen Controls**

On-screen controls allow you to control pan-tilt-zoom (PTZ) cameras. Refer to the camera manual for a list of available features.

From a video screen, select an option:

- To zoom in and out, turn the knob.
- To pan or tilt the camera, use the arrow keys.

## **Configuring the Video Appearance**

**NOTE:** Not all options are available on all camera models and chartplotter models.

- 1 From the video screen, select **MENU > Video Setup**.
- 2 Select an option:
  - To show the video using a stretched aspect ratio, select **Aspect > Stretch**. The video cannot be stretched beyond the dimensions provided by the connected video device, and it may not fill the entire screen.
  - To show the video using a standard aspect ratio, select **Aspect > Standard**.
  - To adjust the brightness, select **Brightness**, and select **Up, Down, or Auto**.
  - To adjust the color saturation, select **Saturation**, and select **Up, Down, or Auto**.
  - To adjust the contrast, select **Contrast**, and select **Up, Down, or Auto**.
  - To allow the chartplotter to automatically select the source format, select **Standard > Auto**.

## **Garmin VIRB® Action Cameras**

Most VIRB action cameras connect to the chartplotter from the camera menu ([Connecting a VIRB Action Camera, page 46](#)).

The VIRB 360 camera connects using the VIRB app ([Connecting a VIRB 360 Action Camera, page 45](#)).

In this manual, the term "VIRB action camera" refers to all models except the VIRB 360 camera. "VIRB 360 camera" refers to only the 360 model.

### **Connecting a VIRB 360 Action Camera**

- 1 Download and open the GarminVIRB app on your mobile device.
- 2 Hold **Wi-Fi** for two seconds to enable the Wi-Fi technology on the camera.
- 3 If you are using an Apple® mobile device, go to the Wi-Fi settings on your mobile device, and connect to the camera access point using the name and password on the camera screen.
- 4 On your mobile device, start the GarminVIRB app.  
The app searches for your camera.
- 5 If you are using a mobile device with Android™, when the security prompt appears, enter the password for the camera access point.  
**TIP:** The access point name and password appear on the camera screen.  
The app connects to your camera.
- 6 Set up the chartplotter's Wi-Fi network.

- 7 From the GarminVIRB app, select  > **WiFi Connections**.  
A list of nearby Wi-Fi access points appears.
- 8 Select the chartplotter's Wi-Fi network, and enter the network password.  
The app and the camera connect to the chartplotter's Wi-Fi network.

### Connecting a VIRB Action Camera

You connect a VIRB action camera to the chartplotter using the camera setting. If you are connecting a VIRB 360 camera, connect through the VIRB app (*Connecting a VIRB 360 Action Camera*, page 45).

- 1 Set up the chartplotter Wi-Fi network *Setting Up the Wi-Fi Wireless Network*, page 5.
- 2 From the VIRB camera main menu, select **Wireless > Wi-Fi > Status** to turn on Wi-Fi wireless technology.
- 3 Select **Mode > Connect**.
- 4 Select **Add New**.  
The camera searches for nearby Wi-Fi networks.
- 5 Select the chartplotter's Wi-Fi network, and enter the network password.  
The app and the camera connect to the chartplotter's Wi-Fi network.

You can control the camera using the chartplotter.



### Controlling the VIRB Action Camera with the Chartplotter

Before you can control a VIRB action camera with the chartplotter, you must connect the devices using a wireless connection (*Connecting a Wireless Device to the Chartplotter*, page 5).



You can connect up to five VIRB action cameras to the chartplotter.

After you connect the VIRB action camera with the chartplotter, a new option is added to **A/V, Gauges, Controls**. You can start and stop recording on the VIRB action camera using the chartplotter.

**NOTE:** The VIRB image shown on the chartplotter is in a lower resolution than the VIRB action camera records. To view the high-resolution video, view the video on a computer or television.

- 1 Select **A/V, Gauges, Controls > VIRB®**.
- 2 Select an option:
  - To take a still photograph, select .
  - To begin recording, select .

When recording, the remaining recording memory is shown.

  - To stop recording, select  again.
  - If you have more than one VIRB action camera connected, use the arrows to select a different action camera to control.
  - To view stored videos or images, select .

### VIRB Action Camera Settings

Select **A/V, Gauges, Controls > VIRB® > MENU**.

**Name:** Allows you to enter a new name for the VIRB action camera.

**Recording:** Starts and stops recording.

**Take Photo:** Takes a still photograph.

**Sleep:** Puts the VIRB action camera into a low power mode to conserve battery power.

### VIRB Action Camera Video Setup Settings

Select **A/V, Gauges, Controls > VIRB® > MENU > Video Setup**.

**Aspect:** Sets the video aspect ratio.

**Video Mode:** Sets the video mode. For example, you can select the **Slow-Mo** option to shoot slow motion videos.

**Video Size:** Sets the size or pixel dimensions of videos.

**Video FPS:** Sets the frames per second.

**Photo Size:** Sets the size or pixel dimensions of photos.

**Field of View:** Sets the zoom level.

### Adding the VIRB Action Camera Controls to Other Screens

Before you can control a VIRB action camera with the chartplotter, you must connect the devices using a wireless connection (*Connecting a Wireless Device to the Chartplotter*, page 5).

You can add the VIRB action camera control bar to other screens. This allows you to start and stop recording from other functions in the chartplotter.





- 1 Open the screen to which you want to add the VIRB action camera control bar.
- 2 Select **MENU > Edit Overlays > Bottom Bar > VIRB Bar**.

When viewing a screen that has the VIRB action camera controls, you can select  to open the full screen view of the VIRB action camera.

### Controlling the VIRB Action Camera Video Playback

You can view VIRB action camera video and images using the chartplotter.

**NOTE:** The VIRB playback on the chartplotter is shown in the same quality as the live view on the chartplotter. To view the high-resolution video, view the video on a computer or television.

- 1 From the **VIRB®** screen, select .
- 2 Wait a few seconds for the thumbnail images to load.
- 3 Select a video or image.
- 4 Control the playback using the on-screen buttons or menu options:
  - To stop the video, select .
  - To pause the video, select .
  - To replay the video, select .
  - To play the video, select .

### Deleting a VIRB Video

You can delete a video or image from the VIRB action camera.

- 1 Open the VIRB video or image to delete.
- 2 Select **MENU > Delete File**.

### Starting a VIRB Video Slideshow

You can view a slideshow of the videos and images on the VIRB action camera.

- 1 From the **VIRB®** screen, select .
- 2 Wait a few seconds for the thumbnail images to load.
- 3 Select a video or image.
- 4 Select **MENU > Start Slideshow**.

To stop the slideshow, select **MENU > Stop Slideshow**.

## Device Configuration

### System Settings

Select **Settings > System**.

**Sounds and Display:** Adjusts the display and audio settings.

**GPS:** Provides information about the GPS satellites and settings.

**System Information:** Provides information about the devices on the network and the software version.

**Station Information:** Adjusts the setup of the station.

**Auto Power Up:** Controls which devices turn on automatically when power is applied.

**Auto Power Off:** Automatically turns off the system after it has been asleep for the selected length of time.

**Simulator:** Turns the simulator on or off and allows you to set the time, date, speed, and simulated location.

## Sounds and Display Settings

Select **Settings > System > Sounds and Display**.

**Beeper:** Turns on and off the tone that sounds for alarms and selections.

**Backlight:** Sets the backlight brightness. You can select the Auto option to adjust the backlight brightness automatically based on the ambient light.

**Backlight Sync:** Synchronizes the backlight brightness of other chartplotters in the station.

**Color Mode:** Sets the device to display day or night colors. You can select the Auto option to allow the device to set day or night colors automatically based on the time of day.

**Startup Image:** Sets the image that appears when you turn on the device.

## GPS Settings

Select **Settings > System > GPS**.

**Skyview:** Shows the relative position of GPS satellites in the sky.

**Settings > Speed Filter:** Averages the speed of your vessel over a short period of time for smoother speed values.

**Settings > WAAS/EGNOS:** Turns on or off WAAS (in North America) or EGNOS (in Europe), which can provide more-accurate GPS position information. When using WAAS or EGNOS, the device may take longer to acquire satellites.

**Settings > GLONASS:** Turns on or off GLONASS usage (Russia satellite system). When the system is used in situations with poor sky visibility, this configuration can be used in combination with GPS to provide more accurate position information.

**Source:** Allows you to select the preferred source for GPS.

## Station Settings

Select **Settings > System > Station Information**.

**Change Station:** Sets the entire station to a new set of defaults based on the location of this station. You can also select to use this display as a stand-alone, individual display, instead of grouping it with other displays to make a station.

**GRID™ Pairing:** Allows you to pair a GRID™ remote input device with this station.

**Display Order:** Sets the order of the displays, which is important when using a GRID remote input device.

**Autopilot Enabled:** Allows you to control the autopilot from this device.

**Reset Layouts:** Restores the factory default view for the layouts in this station.

**Reset Stations:** Restores the factory default layouts for all displays in the station.

## Viewing System Software Information

You can view the software version, the basemap version, all supplemental map information (if applicable), the software version for an optional Garmin radar (if applicable), and the unit ID number. You may need this information to update the system software or to purchase additional map data information.

Select **Settings > System > System Information > Software Information**.

## Viewing the Event Log

The event log shows a list of system events.

Select **Settings > System > System Information > Event Log**.

## Preferences Settings

Select **Settings > Preferences**.

**Units:** Sets units of measure.

**Language:** Sets the on-screen text language.

**Navigation:** Sets navigation preferences.

**Keyboard Layout:** Arranges the keys on the on-screen keyboard.

**Screenshot Capture:** Allows the device to save images of the screen.

**User Data Sharing:** Allows you to share waypoints and routes over the Garmin Marine Network. All chartplotters that share waypoints and routes must have this setting turned on.

**Menu Bar Display:** Shows or automatically hides the menu bar when it is not needed.

## Units Settings

Select **Settings > Preferences > Units**.

**System Units:** Sets the unit format for the device.

**Variance:** Sets the magnetic declination, the angle between magnetic north and true north, for your present location.

**North Reference:** Sets the direction references used in calculating heading information. True sets geographic north as the north reference. Grid sets grid north as the north reference (000°). Magnetic sets the magnetic north as the north reference.

**Position Format:** Sets the position format in which a given location reading appears. Do not change this setting unless you are using a map or chart that specifies a different position format.

**Map Datum:** Sets the coordinate system on which the map is structured. Do not change this setting unless you are using a map or chart that specifies a different map datum.

**Time:** Sets the time format, time zone, and daylight saving time.

## Navigation Settings

**NOTE:** Some settings and options require additional charts or hardware.

Select **Settings > Preferences > Navigation**.

**Route Labels:** Sets the type of labels shown with route turns on the map.

**Turn Transition:** Adjusts how the chartplotter transitions to the next turn or leg or the route. You can set the transition to be based on time or distance before the turn. You can increase the time or distance value to help improve the accuracy of the autopilot when navigating a route or an Auto Guidance line with many frequent turns or at higher speeds. For straighter routes or slower speeds, lowering this value can improve autopilot accuracy.

**Speed Sources:** Sets the source for the speed readings.

**Auto Guidance:** Sets the measurements for the Preferred Depth, Vertical Clearance, and Shoreline Distance, when you are using some premium maps.

**Route Start:** Selects a starting point for route navigation.

## Auto Guidance Path Configurations

### CAUTION

The Preferred Depth and Vertical Clearance settings influence how the chartplotter calculates an Auto Guidance path. If an area has an unknown water depth or an unknown obstacle height, the Auto Guidance path is not calculated in that area. If an area at the beginning or the end of an Auto Guidance path is shallower than the Preferred Depth or lower than the Vertical Clearance settings, the Auto Guidance path may not be

calculated in that area, depending on the map data. On the chart, the course through those areas appears as a gray line or a magenta and gray striped line. When your boat enters one of those areas, a warning message appears.

**NOTE:** Auto Guidance is available with premium charts, in some areas.

**NOTE:** Not all settings apply to all maps.

You can set the parameters the chartplotter uses when calculating an Auto Guidance path.

**Preferred Depth:** Sets the minimum water depth, based on chart depth data, that your boat can safely travel over.

**NOTE:** The minimum water depth for the premium charts (made before 2016) is 3 feet. If you enter a value of less than 3 feet, the charts only use depths of 3 feet for Auto Guidance path calculations.

**Vertical Clearance:** Sets the minimum height of a bridge or obstacle, based on chart data, that your boat can safely travel under.

**Shoreline Distance:** Sets how close to the shore you want the Auto Guidance path to be placed. The Auto Guidance path may move if you change this setting while navigating. The available values for this setting are relative, not absolute. To ensure that the Auto Guidance line is placed the appropriate distance from shore, you can assess the placement of the Auto Guidance path using one or more familiar destinations that require navigation through a narrow waterway (*Adjusting the Distance from Shore*, page 17).

### Adjusting the Distance from Shore

The Shoreline Distance setting indicates how close to the shore you want the Auto Guidance line to be placed. The Auto Guidance line may move if you change this setting while navigating. The available values for the Shoreline Distance setting are relative, not absolute. To ensure the Auto Guidance line is placed the appropriate distance from shore, you can assess the placement of the Auto Guidance line using one or more familiar destinations that require navigation through a narrow waterway.

- 1 Dock your vessel or drop the anchor.
- 2 Select **Settings > Preferences > Navigation > Auto Guidance > Shoreline Distance > Normal**.
- 3 Select a destination that you have navigated to previously.
- 4 Select **Navigate To > Auto Guidance**.
- 5 Review the placement of the Auto Guidance line, and determine whether the line safely avoids known obstacles and the turns enable efficient travel.
- 6 Select an option:
  - If the placement of the Auto Guidance line is satisfactory, select **MENU > Navigation Options > Stop Navigation**, and proceed to step 10.
  - If the Auto Guidance line is too close to known obstacles, select **Settings > Preferences > Navigation > Auto Guidance > Shoreline Distance > Far**.
  - If the turns in the Auto Guidance line are too wide, select **Settings > Preferences > Navigation > Auto Guidance > Shoreline Distance > Near**.
- 7 If you selected **Near** or **Far** in step 6, review the placement of the Auto Guidance line, and determine whether the line safely avoids known obstacles and the turns enable efficient travel.

Auto Guidance maintains a wide clearance from obstacles in open water, even if you set the Shoreline Distance setting to **Near** or **Nearest**. As a result, the chartplotter may not reposition the Auto Guidance line, unless the destination selected requires navigation through a narrow waterway.

- 8 Select an option:

- If the placement of the Auto Guidance line is satisfactory, select **MENU > Navigation Options > Stop Navigation**, and proceed to step 10.
- If the Auto Guidance line is too close to known obstacles, select **Settings > Preferences > Navigation > Auto Guidance > Shoreline Distance > Farthest**.
- If the turns in the Auto Guidance line are too wide, select **Settings > Preferences > Navigation > Auto Guidance > Shoreline Distance > Nearest**.

- 9 If you selected **Nearest** or **Farthest** in step 8, review the placement of the **Auto Guidance** line, and determine whether the line safely avoids known obstacles and the turns enable efficient travel.

Auto Guidance maintains a wide clearance from obstacles in open water, even if you set the Shoreline Distance setting to **Near** or **Nearest**. As a result, the chartplotter may not reposition the Auto Guidance line, unless the destination selected requires navigation through a narrow waterway.

- 10 Repeat steps 3 through 9 at least once more, using a different destination each time, until you are familiar with the functionality of the Shoreline Distance setting.

## Communications Settings

### NMEA 0183 Settings

Select **Settings > Communications > NMEA 0183 Setup**.

**Port Types:** See *Setting the Communication Format for Each NMEA 0183 Port*, page 48.

**Output Sentences:** See *Configuring NMEA 0183 Output Sentences*, page 48.

**Position Precision:** Adjusts the number of digits to the right of the decimal point for transmission of NMEA output.

**XTE Precision:** Adjusts the number of digits to the right of the decimal point for NMEA crosstalk error output.

**Waypoint IDs:** Sets the device to transmit waypoint names or numbers via NMEA 0183 while navigating. Using numbers may resolve compatibility issues with older NMEA 0183 autopilots.

**Defaults:** Restores the NMEA 0183 settings to the original factory defaults.

**Diagnostics:** Displays NMEA 0183 diagnostic information.

### Configuring NMEA 0183 Output Sentences

You can enable and disable NMEA 0183 output sentences.

- 1 Select **Settings > Communications > NMEA 0183 Setup > Output Sentences**.
- 2 Select an option.
- 3 Select one or more NMEA 0183 output sentences, and select **BACK**.
- 4 Repeat steps 2 and 3 to enable or disable additional output sentences.

### Setting the Communication Format for Each NMEA 0183 Port

You can configure the communication format for each internal NMEA 0183 port when connecting your chartplotter to external NMEA 0183 devices, a computer, or other Garmin devices.

- 1 Select **Settings > Communications > NMEA 0183 Setup > Port Types**.
- 2 Select an input or output port.
- 3 Select a format:
  - To support the input or output of standard NMEA 0183 data, DSC, and sonar NMEA input support for the DPT, MTW, and VHW sentences, select **NMEA Std..**
  - To support the input or output of standard NMEA 0183 data for most AIS receivers, select **NMEA High Speed**.



- To support the input or output of Garmin proprietary data for interfacing with Garmin software, select **Garmin**.

4 Repeat steps 2–3 to configure additional input or output ports.

## NMEA 2000 Settings

Select **Settings > Communications > NMEA 2000 Setup**.

**Device List:** Displays the devices connected to the network.

**Label Devices:** Changes the labels for available connected devices.

### Naming Devices and Sensors on the Network

You can name devices and sensors connected to the Garmin Marine Network and the NMEA 2000 network.

- 1 Select **Settings > Communications**.
- 2 Select **Marine Network** or **NMEA 2000 Setup > Device List**.
- 3 Select a device from the list on the left.
- 4 Select **Change Name**.
- 5 Enter the name, and select **Done**.

## Marine Network

The Marine Network allows you to share data from Garmin peripheral devices with the chartplotters quickly and easily. You can connect a chartplotter to the Marine Network to receive data from and share data with other devices and chartplotters that are compatible with the Marine Network.

Select **Settings > Communications > Marine Network**.

## Setting Alarms

### Navigation Alarms

Select **Settings > Alarms > Navigation**.

**Arrival:** Sets an alarm to sound when you are within a specified distance or time from a turn or a destination.

**Anchor Drag:** Sets an alarm to sound when you exceed a specified drift distance while anchored.

**Off Course:** Sets an alarm to sound when you are off course by a specified distance.

### Setting the Anchor Drag Alarm

You can set an alarm to sound if you have moved more than an allowable distance. This is very useful when anchoring overnight.

- 1 Select **Settings > Alarms > Navigation > Anchor Drag**.
- 2 Select **Alarm** to turn on the alarm.
- 3 Select **Set Radius**, and select a distance on the chart.
- 4 Select **BACK**.

### System Alarms

**Alarm Clock:** Sets an alarm clock.

**Unit Voltage:** Sets an alarm to sound when the battery reaches a specified low voltage.

**GPS Accuracy:** Sets an alarm to sound when the GPS location accuracy falls outside the user-defined value.

### Sonar Alarms

**NOTE:** Not all options are available on all transducers.

From an applicable sonar view, select **MENU > Sonar Setup > Alarms**.

You can also open the sonar alarms by selecting **Settings > Alarms > Sonar**.

**Shallow Water:** Sets an alarm to sound when the depth is less than the specified value.



**Deep Water:** Sets an alarm to sound when the depth is greater than the specified value.

**FrontVü Alarm:** Sets an alarm to sound when the depth in front of the vessel is less than the specified value, which can help you avoid running aground ([Setting the FrontVü Depth Alarm, page 28](#)). This alarm is available only with Panoptix FrontVü transducers.

**Water Temp.:** Sets an alarm to sound when the transducer reports a temperature that is 2°F (1.1°C) above or below the specified temperature.

**Contour:** Sets an alarm to sound when the transducer detects a suspended target within the specified depth from the surface of the water and from the bottom.

**Fish:** Sets an alarm to sound when the device detects a suspended target.

-  sets the alarm to sound when fish of all sizes are detected.
-  sets the alarm to sound only when medium or large fish are detected.
-  sets the alarm to sound only when large fish are detected.

## Setting Weather Alarms

Before you can set weather alarms, you must have a compatible chartplotter connected to a weather device, such as a GXM device, and have a valid weather subscription.

- 1 Select **Settings > Alarms > Weather**.
- 2 Turn on alarms for specific weather events.

## Setting the Fuel Alarm

Before you can set a fuel level alarm, a compatible fuel flow sensor must be connected to the chartplotter.

You can set an alarm to sound when the total amount of remaining onboard fuel reaches the level you specify.

- 1 Select **Settings > Alarms > Fuel > Set Total Fuel Onboard > On**.
- 2 Enter the remaining amount of fuel that triggers the alarm, and select **Done**.

## My Vessel Settings

**NOTE:** Some settings and options require additional charts or hardware.

Select **Settings > My Vessel**.

**Depth and Anchoring:** Allows you to enter information about the keel ([Setting the Keel Offset, page 20](#)) and the anchor.

**Temp. Offset:** Allows you to set an offset value to compensate for the water temperature reading from a NMEA 0183 water-temperature sensor or a temperature-capable transducer ([Setting the Water Temperature Offset, page 50](#)).

**Calibrate Water Speed:** Calibrates the speed-sensing transducer or sensor ([Calibrating a Water Speed Device, page 50](#)).

**Fuel Capacity:** Sets the combined fuel capacity of all the fuel tanks on your vessel ([Setting the Fuel Capacity of the Vessel, page 37](#)).

**Vessel Type:** Enables some chartplotter features based on the boat type.

**CZone™:** Sets the digital switching circuits.

**System Profiles:** Allows you to save your system profile to a memory card and import system profile settings from a memory card. This can be helpful for charter or fleet vessels, and for sharing your setup information with a friend.

## Setting the Keel Offset

You can enter a keel offset to compensate the water depth reading for the transducer installation location. This allows you to view the depth of the water below the keel or the true depth of the water, depending on your needs.

If you want to know the water depth below the keel or the lowest point of your boat and the transducer is installed at the water line or anywhere above the end of the keel, measure the distance from the transducer location to the keel of the boat.

If you want to know the true water depth and the transducer is installed below the water line, measure the distance from the bottom of the transducer up to the water line.

**NOTE:** This option is only available when you have valid depth data.

1 Measure the distance:

- If the transducer is installed at the water line ① or anywhere above the end of the keel, measure the distance from the transducer location to the keel of the boat. Enter this value as a positive number.
- If the transducer is installed at the bottom of the keel ② and you want to know the true depth of the water, measure the distance from the transducer to the water line. Enter this value in as a negative number.

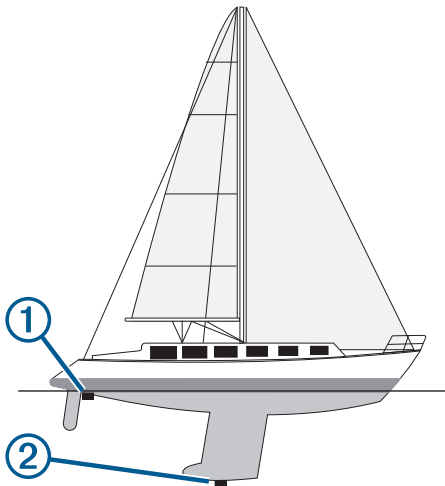

2 Select **Settings > My Vessel > Depth and Anchoring > Keel Offset**.

3 Select **+** if the transducer is installed at the water line, or select **-** if the transducer is installed at the bottom of the keel.

4 Use the arrow keys to enter the keel offset measured in step 1.

### Setting the Water Temperature Offset

Before you can set the water temperature offset, you must have a NMEA 0183 water-temperature sensor or a temperature-capable transducer to measure water temperature.

The temperature offset compensates for the temperature reading from a temperature sensor.

1 Measure the water temperature using the temperature sensor or temperature-capable transducer that is connected to the chartplotter.

2 Measure the water temperature using a different temperature sensor or a thermometer that is known to be accurate.

3 Subtract the water temperature measured in step 1 from the water temperature measured in step 2.

This is the temperature offset. Enter this value in step 5 as a positive number if the sensor connected to the chartplotter measures the water temperature as being colder than it actually is. Enter this value in step 5 as a negative number if the sensor connected to the chartplotter measures the water temperature as being warmer than it actually is.

4 Select **Settings > My Vessel > Temp. Offset**.

5 Enter the temperature offset calculated in step 3.

### Calibrating a Water Speed Device

If you have a speed-sensing transducer connected to the chartplotter, you can calibrate that speed-sensing device to improve the accuracy of water-speed data displayed by the chartplotter.

1 Select **Settings > My Vessel > Calibrate Water Speed**.

2 Follow the on-screen instructions.

If the boat is not moving fast enough or the speed sensor is not registering a speed, a message appears.

3 Select **OK**, and safely increase the boat speed.

4 If the message appears again, stop the boat, and ensure the speed-sensor wheel is not stuck.

5 If the wheel turns freely, check the cable connections.

6 If you continue to get the message, contact Garmin product support.

### Other Vessels Settings

When your compatible chartplotter is connected to an AIS device or VHF radio, you can set up how other vessels are displayed on the chartplotter.

Select **Settings > Other Vessels**.

**AIS:** Enables and disables AIS signal reception.

**DSC:** Enables and disables digital selective calling (DSC).

**Collision Alarm:** Sets the collision alarm ([Setting the Safe-Zone Collision Alarm, page 9](#)).

**AIS-EPIRB Test:** Enables test signals from Emergency Position Indicating Radio Beacons (EPIRB).

**AIS-MOB Test:** Enables test signals from man overboard (MOB) devices.

**AIS-SART Test:** Enables test transmissions from Search and Rescue Transponders (SART).

### Settings that are Synced on the Garmin Marine Network

The following devices sync certain settings when connected to the Garmin Marine Network.

- echoMAP™ 70 series
- GPSMAP 507 series (software version 3.0 or later)
- GPSMAP 701 series (software version 3.0 or later)
- GPSMAP 702 series
- GPSMAP 800 series
- GPSMAP 902 series
- GPSMAP 1000 series
- GPSMAP 1002 series
- GPSMAP 1202 series
- GPSMAP 7400/7600 series
- GPSMAP 8400/8600 series

The following settings are synced, if applicable, to the device.

Alarm Settings (also syncs alarm acknowledgment):

- Arrival
- Anchor Drag
- Off Course
- GPS Accuracy
- Shallow Water
- Deep Water (Not available in the GPSMAP 8400/8600 series)
- Water Temp.
- Contour (Not available in echoMAP 70s and GPSMAP 507/701 series)
- Fish

- Collision Alarm

#### General Settings:

- Auto Guidance Preferred Depth
- Auto Guidance Vertical Clearance
- Beeper
- Color Mode
- Keyboard Layout
- Language
- Map Datum
- North Reference
- Position Format
- System Units
- Calibrate Water Speed
- Radar Antenna Size

#### Chart Settings:

- Chart Borders
- Hazard Colors
- Heading Line
- Land POIs
- Light Sectors
- Navaid Size
- Navaid Type
- Photo Points
- Preferred Depth
- Shallow Shading
- Service Points
- Vessel Icon (Cannot be synced between all models)

## Restoring the Original Chartplotter Factory Settings

**NOTE:** This procedure deletes all settings information you have entered.

- 1 Select **Settings > System > System Information > Factory Settings**.
- 2 Select an option.

## Sharing and Managing User Data

You can share and manage user data using a memory card. You must have a memory card installed in the device. This device supports up to a 32 GB memory card, formatted to FAT32.

### Copying Waypoints, Routes, and Tracks from HomePort to a Chartplotter

Before you can copy data to the chartplotter, you must have the latest version of the HomePort software program loaded on your computer and a memory card installed in the chartplotter.

- Copy the data from HomePort to the prepared memory card.
- For more information, see the HomePort help file.

### Selecting a File Type for Third-Party Waypoints and Routes

You can import and export waypoints and routes from third-party devices.

- 1 Insert a memory card into the card slot.
- 2 Select **NAV INFO > User Data > Data Transfer > File Type**.
- 3 Select **GPX**.

To transfer data with Garmin devices again, select the ADM file type.

### Copying User Data from a Memory Card

You can transfer user data from a memory card to transfer from other devices. User data includes waypoints, routes, Auto Guidance paths, tracks, and boundaries.

**NOTE:** Only boundary files with an .adm extension are supported.

- 1 Insert a memory card into a card slot.
- 2 Select **NAV INFO > User Data > Data Transfer**.
- 3 If necessary, select the memory card to copy data to.
- 4 Select an option:
  - To transfer data from the memory card to the chartplotter and combine it with existing user data, select **Merge from Card**.
  - To transfer data from the memory card to the chartplotter and overwrite existing user data, select **Replace from Card**.
- 5 Select the file name.

### Copying User Data to a Memory Card

You can save user data to a memory card to transfer to other devices. User data includes waypoints, routes, Auto Guidance paths, tracks, and boundaries.

- 1 Insert a memory card into the card slot.
- 2 Select **NAV INFO > User Data > Data Transfer > Save to Card**.
- 3 If necessary, select the memory card to copy the data to.
- 4 Select an option:
  - To create a new file, select **Add New File**, and enter a name.
  - To add the information to an existing file, select the file from the list, and select **Save to Card**.

### Copying Built-In Maps to a Memory Card

You can copy maps from the chartplotter to a memory card for use with HomePort.

- 1 Insert a memory card into the card slot.
- 2 Select **NAV INFO > User Data > Data Transfer**.
- 3 Select **Copy Built-In Map**.

### Backing Up Data to a Computer

- 1 Insert a memory card into the card slot.
- 2 Select **NAV INFO > User Data > Data Transfer > Save to Card**.
- 3 Select a file name from the list, or select **Add New File**.
- 4 Select **Save to Card**.
- 5 Remove the memory card, and insert it into a card reader attached to a computer.
- 6 Open the Garmin\UserData folder on the memory card.
- 7 Copy the backup file on the card and paste it to any location on the computer.

### Restoring Backup Data to a Chartplotter

- 1 Insert a memory card into a card reader that is attached to the computer.
- 2 Copy a backup file from the computer to the memory card, into a folder named Garmin\UserData.
- 3 Insert a memory card into the card slot.
- 4 Select **NAV INFO > User Data > Data Transfer > Replace from Card**.

## Saving System Information to a Memory Card

You can save system information to a memory card as a troubleshooting tool. A product support representative may ask you to use this information to retrieve data about the network.

- 1 Insert a memory card into the card slot.
- 2 Select **Settings > System > System Information > Garmin Devices > Save to Card**.
- 3 If necessary, select the memory card to save system information to.
- 4 Remove the memory card.

## Appendix

### Registering Your Device

**NOTE:** You should use the ActiveCaptain app to register the device (*Getting Started with the ActiveCaptain App*, page 4).

Help us better support you by completing our online registration today. Keep the original sales receipt, or a photocopy, in a safe place.

- 1 Insert a memory card into the card slot on the chartplotter.
- 2 Wait a few moments.  
The chartplotter opens the card management page and creates a file named GarminDevice.xml in the Garmin folder on the memory card.
- 3 Remove the memory card.
- 4 Insert the memory card into your computer.
- 5 On your computer, go to [garmin.com/express](http://garmin.com/express).
- 6 Follow the on-screen instructions to download, install, and open the Garmin Express application.
- 7 Select **+** > **Add a Device**.
- 8 While the application searches, select **Sign In** next to **Have marine charts or devices?** near the bottom of the screen.
- 9 Create or sign in to your Garmin account.
- 10 Follow the on-screen instructions to set up your vessel.
- 11 Select **+** > **Add**.  
The Garmin Express application searches the memory card for the device information.
- 12 Select **Add Device** to register the device.  
When registration is complete, the Garmin Express application searches for additional charts and chart updates for your device.

When you add devices to the chartplotter network, repeat these steps to register the new devices.

### Software Update

**NOTE:** You can use the ActiveCaptain app to update the device software (*Updating Software with the ActiveCaptain App*, page 5).

You may need to update the device software when you install the device or add an accessory to the device.

This device supports up to a 32 GB memory card, formatted to FAT32.

Before you update the software, you can check to the software version installed on your device (*Viewing System Software Information*, page 47). Then, you can go to [www.garmin.com/support/software/marine.html](http://www.garmin.com/support/software/marine.html), select See All Devices in this Bundle, and compare the installed software version to the software version listed for your product.

If the software on your device is older than the one listed on the website, follow the steps to load the software on a memory card

(*Loading the New Software on a Memory Card*, page 52), and then update the device software (*Updating the Device Software*, page 52).

### Loading the New Software on a Memory Card

You must copy the software update to a memory card using a computer that is running Windows® software.

**NOTE:** You can contact Garmin customer support to order a preloaded software update card if you do not have a computer with Windows software.

- 1 Insert a memory card into the card slot on the computer.
- 2 Go to [www.garmin.com/support/software/marine.html](http://www.garmin.com/support/software/marine.html).

**TIP:** You can also download updated owner's manuals to load on the chartplotter from this web page.

- 3 Select **GPSMAP Series with SD Card**.
- 4 Select **Download** next to **GPSMAP Series with SD Card**.

- 5 Read and agree to the terms.

- 6 Select **Download**.

- 7 Choose a location, and select **Save**.

- 8 Double-click the downloaded file.

A Garmin folder containing the software update is created in the selected location. A dialog box opens to assist in transferring the software update to a memory card.

- 9 Select **Next**.

- 10 Select the drive associated with the memory card, and select **Next > Finish**.

A Garmin folder containing the software update is created on the memory card. The software update can take several minutes to load onto the memory card.

### Updating the Device Software

Before you can update the software, you must obtain a software-update memory card or load the latest software onto a memory card (*Loading the New Software on a Memory Card*, page 52).

- 1 Turn on the chartplotter.

- 2 After the home screen appears, insert the memory card into the card slot.

**NOTE:** In order for the software update instructions to appear, the device must be fully booted before the card is inserted.

- 3 Follow the on-screen instructions.

- 4 Wait several minutes while the software update process completes.

- 5 When prompted, leave the memory card in place and restart the chartplotter manually.

- 6 Remove the memory card.

**NOTE:** If the memory card is removed before the device restarts fully, the software update is not complete.

### Digital Switching

Your chartplotter can be used to monitor or control circuits when a compatible system is connected.

For example, you can control the interior lights and navigation lights on the vessel. You can also monitor live well circuits.

To access the digital switching controls, select **NAV INFO > Circuit Control**.

For more information about purchasing and configuring a digital switching system, contact your Garmin dealer.

## Pairing the GRID Remote Input Device with the Chartplotter

Before you can use a GRID remote input device with a chartplotter, you must pair the devices.

You can initiate the pairing of the devices from the chartplotter or from the GRID remote input device.

### Pairing the GRID Device with the Chartplotter from the Chartplotter

- 1 Select **Settings > System > Station Information > GRID™ Pairing > Add**.
- 2 On the GRID remote input device, press **SELECT**.

### Pairing the GRID Device with the Chartplotter from the GRID Device

- 1 On the GRID remote input device, press **+** and **HOME** at the same time.  
A selection page opens on all of the chartplotters on the Garmin Marine Network.
- 2 Rotate the wheel on the GRID remote input device to highlight **SELECT** on the chartplotter you want to control with the GRID remote input device.
- 3 Press **SELECT**.

### Rotating the GRID Joystick

For certain installation situations, you can rotate the orientation of the GRID joystick.

- 1 Select **Settings > Communications > Marine Network**.
- 2 Select the GRID device.

## Cleaning the Screen

### NOTICE

Cleaners containing ammonia will harm the anti-reflective coating.

The device is coated with a special anti-reflective coating which is very sensitive to waxes and abrasive cleaners.

- 1 Apply an eyeglass lens cleaner specified as safe for anti-reflective coatings to the cloth.
- 2 Gently wipe the screen with a soft, clean, lint-free cloth.

## Viewing Images on a Memory card

You can view images that are saved on a memory card. You can view .jpg, .png, and .bmp files.

- 1 Insert a memory card with image files into the card slot.
- 2 Select **NAV INFO > Image Viewer**.
- 3 Select the folder containing the images.
- 4 Wait a few seconds for the thumbnail images to load.
- 5 Select an image.
- 6 Use the arrows to scroll through the images.
- 7 If necessary, select **MENU > Start Slideshow**.

## Screenshots

You can capture a screenshot of any screen shown on your chartplotter as a bitmap (.bmp) file. You can transfer the screenshot to your computer. You can also view the screenshot in the image viewer (*Viewing Images on a Memory card*, page 53).

### Capturing Screenshots

- 1 Insert a memory card into the card slot.
- 2 Select **Settings > Preferences > Screenshot Capture > On**.
- 3 Go to a screen you want to capture.
- 4 Hold **HOME** for at least six seconds.

## Copying Screenshots to a Computer

- 1 Remove the memory card from the chartplotter, and insert it into a card reader that is attached to a computer.
- 2 From Windows Explorer, open the `Garmin\scrn` folder on the memory card.
- 3 Copy a .bmp file from the card and paste it to any location on the computer.

## Troubleshooting

### My device will not acquire GPS signals

If the device is not acquiring satellite signals, there could be a few causes. If the device has moved a large distance since the last time it has acquired satellites or has been turned off for longer than a few weeks or months, the device may not be able to acquire the satellites correctly.

- Ensure the device is using the latest software. If not, update the device software.
- Make sure the device has a clear view of the sky so the antenna can receive the GPS signal. If it is mounted inside of a cabin, it should be close to a window so it can receive the GPS signal.

### My device will not turn on or keeps turning off

Devices erratically turning off or not turning on could indicate an issue with the power supplied to the device. Check these items to attempt to troubleshoot the cause of the power issue.

- Make sure the power source is generating power.  
You can check this several ways. For example, you can check whether other devices powered by the source are functioning.
- Check the fuse in the power cable.  
The fuse should be located in a holder that is part of the red wire of the power cable. Check that the proper size fuse is installed. Refer to the label on the cable or the installation instructions for the exact fuse size needed. Check the fuse to make sure there is still a connection inside of the fuse. You can test the fuse using a multimeter. If the fuse is good, the multimeter reads 0 ohm.
- Check to make sure the device is receiving is at least 10 V, but 12 V is recommended.  
To check the voltage, measure the female power and ground sockets of the power cable for DC voltage. If the voltage is less than 10 V, the device will not turn on.
- If the device is receiving enough power but does not turn on, contact Garmin product support at [support.garmin.com](http://support.garmin.com).

### My device is not creating waypoints in the correct location

You can manually enter a waypoint location to transfer and share data from one device to the next. If you have manually entered a waypoint using coordinates, and the location of the point does not appear where the point should be, the map datum and position format of the device may not match the map datum and position format originally used to mark the waypoint.

Position format is the way in which the GPS receiver's position appears on the screen. This is commonly displayed as latitude/longitude in degrees and minutes, with options for degrees, minutes and second, degrees only, or one of several grid formats.

Map datum is a math model which depicts a part of the surface of the earth. Latitude and longitude lines on a paper map are referenced to a specific map datum.

- 1 Find out which map datum and position format was used when the original waypoint was created.

If the original waypoint was taken from a map, there should be a legend on the map that lists the map datum and position

format used to create that map. Most often this is found near the map key.

2 Select **Settings > Preferences > Units**.

3 Select the correct map datum and position format settings.

4 Create the waypoint again.

## Contacting Garmin Support

- Go to [support.garmin.com](http://support.garmin.com) for help and information, such as product manuals, frequently asked questions, videos, and customer support.
- In the USA, call 913-397-8200 or 1-800-800-1020.
- In the UK, call 0808 238 0000.
- In Europe, call +44 (0) 870 850 1241.

## Specifications

### Specifications

Device	Specification	Measurement
Ten-inch models	Dimensions (W x H x D)	318 x 185 x 69 mm (12 1/2 x 7 5/16 x 2 11/16 in.)
	Weight	4.1 lbs (1.85 kg)
	Display size (W x H)	224 x 125 mm (8 3/4 x 4 15/16 in.)
	Display type	WSVGA
	Display resolution	1024 x 600 pixels
	Weight	0.86 kg (1.9 lbs)
	Max. power usage at 10 Vdc	32.4 W
	Typical current draw at 12 Vdc	1.9 A
	Max. current draw at 12 Vdc	2.7 A
Twelve-inch models	Dimensions (W x H x D)	359 x 227 x 69 mm (14 1/8 x 8 15/16 x 2 11/16 in.)
	Weight	1.14 kg (2.5 lbs)
	Display size (W x H)	262 x 164 mm (10 5/16 x 6 7/16 in.)
	Display type	WXGA
	Display resolution	1280 x 800 pixels
	Max. power usage at 10 Vdc	34.8 W
	Typical current draw at 12 Vdc	2.2 A
	Max. current draw at 12 Vdc	2.9 A
	Sonar models	Frequencies*
Transmit power (RMS)**		CHIRP: 1,000 W Garmin ClearVü and SideVü CHIRP: 500 W
Depth***		5,000 ft at 1 kW
All models	Temperature range	From -15° to 50°C (from 5° to 122°F)
	Material	Polycarbonate plastic and die-cast aluminum
	Water rating****	IEC 60529 IPX7
	Fuse	6 A, 125 V fast-acting
	Input power	From 10 to 32 Vdc
	Memory card	2 SD® card slots; 32 GB max. card size
	Max. waypoints	5,000

Device	Specification	Measurement
	Max. routes	100
	Max. active track points	50,000 points, 50 saved tracks
	Compass-safe distance	65 cm (25.5 in.)
	NMEA 2000 LEN	2
	NMEA 2000 draw	75 mA max.

\* Dependent upon transducer.

\*\*Dependent upon transducer rating and depth.

\*\*\*Dependent upon the transducer, water salinity, bottom type, and other water conditions.

\*\*\*\*The device withstands incidental exposure to water of up to 1 m for up to 30 min. For more information, go to [www.garmin.com/waterrating](http://www.garmin.com/waterrating).

### NMEA 2000 PGN Information

#### Transmit and Receive

PGN	Description
059392	ISO acknowledgment
059904	ISO request
060160	ISO transport protocol: Data transfer
060416	ISO transport protocol: Connection management
060928	ISO address claimed
065240	Commanded address
126208	Request group function
126996	Product information
126998	Configuration information
127237	Heading/track control
127250	Vessel heading
127258	Magnetic variance
127488	Engine parameters: Rapid update
127489	Engine parameters: Dynamic
127493	Transmission parameters: Dynamic
127505	Fluid level
127508	Battery status
128259	Speed: Water referenced
128267	Water depth
129025	Position: Rapid update
129026	COG and SOG: Rapid update
129029	GNSS position data
129283	Cross track error
129284	Navigation data
129539	GNSS DOPs
129540	GNSS satellites in view
130306	Wind data
130310	Environmental parameters (obsolete)
130311	Environmental parameters (obsolete)
130312	Temperature (obsolete)

#### Transmit

PGN	Description
126464	Transmit and receive PGN list group function
127497	Trip parameters: Engine

#### Receive

PGN	Description
065030	Generator average basic AC quantities (GAAC)
126992	System time

PGN	Description
127251	Rate of turn
127257	Attitude
127498	Engine parameters: Static
127503	AC input status (obsolete)
127504	AC output status (obsolete)
127506	DC detailed status
127507	Charger status
127509	Inverter status
128275	Distance log
129038	AIS class A position report
129039	AIS class B position report
129040	AIS class B extended position report
129044	Datum
129285	Navigation: Route, waypoint information
129794	AIS class A static and voyage related data
129798	AIS SAR aircraft position report
129799	Radio frequency/mode/power
129802	AIS safety-related broadcast message
129808	DSC call Information
129809	AIS class B "CS" static data report, part A
129810	AIS class B "CS" static data report, part B
130313	Humidity
130314	Actual pressure
130316	Temperature: Extended range
130576	Trim tab status
130577	Direction data

Type	Sentence	Description
	MTW	Water temperature
	VHW	Water speed and heading
	WPL	Waypoint location
	DSC	Digital selective calling information
	DSE	Expanded digital selective calling
	HDG	Heading, deviation, and variation
	HDM	Heading, magnetic
	MWD	Wind direction and speed
	MDA	Meteorological composite
	MWV	Wind speed and angle
	VDM	AIS VHF data-link message

You can purchase complete information about National Marine Electronics Association (NMEA) format and sentences from: NMEA, Seven Riggs Avenue, Severna Park, MD 21146 USA ([www.nmea.org](http://www.nmea.org))

## NMEA 0183 Information

Type	Sentence	Description
Transmit	GPAPB	APB: Heading or track controller (autopilot) sentence "B"
	GPBOD	BOD: Bearing (origin to destination)
	GPBWC	BWC: Bearing and distance to waypoint
	GPGGA	GGA: Global positioning system fix data
	GPGLL	GLL: Geographic position (latitude and longitude)
	GPGSA	GSA: GNSS DOP and active satellites
	GPGSV	GSV: GNSS satellites in view
	GPRMB	RMB: Recommended minimum navigation information
	GPRMC	RMC: Recommended minimum specific GNSS data
	GPRTE	RTE: Routes
	GPVTG	VTG: Course over ground and ground speed
	GPWPL	WPL: Waypoint location
	GPXTE	XTE: Cross track error
	PGRME	E: Estimated error
	PGRMM	M: Map datum
	PGRMZ	Z: Altitude
	SDDBT	DBT: Depth below transducer
	SDDPT	DPT: Depth
	SDMTW	MTW: Water temperature
	SDVHW	VHW: Water speed and heading
Receive	DPT	Depth
	DBT	Depth below transducer

# Index

## A

- ActiveCaptain 4
  - quickdraw 12
  - smart notifications 4
  - updating charts 5
  - updating software 5
- aerial photos 8
- AIS 8–11
  - distress signal device 9
  - radar 31
  - SART 9
  - targeting 8, 9
  - threats 9, 31
  - turning on 50
- alarms 18, 49
  - anchor drag 49
  - arrival 49
  - collision 9, 50
  - deep water 26, 49
  - engine 37
  - fuel 37, 49
  - gauges 37
  - navigation 49
  - off course 49
  - shallow water 26, 49
  - sonar 26, 49
  - water temperature 26, 49
  - weather 49
- AM 40
- anchor 49
- anchor drag alarm 49
- animated currents, tides 8
- antenna, GPS 2
- arrival alarm 49
- Auto Guidance 13, 14, 16, 47
  - paths 16
  - shoreline distance 17, 48
- autopilot 33, 34
  - adjusting the heading 34
  - circles pattern 34
  - cloverleaf pattern 35
  - engaging 34
  - orbit pattern 35
  - pattern steering 34, 35
  - reducing rudder activity 34
  - search pattern 35
  - Shadow Drive 34
  - steering increment 34
  - steering patterns 34, 35
  - u-turn pattern 34
  - Williamson turn pattern 35
  - zigzag pattern 35

## B

- backlight 3, 5
- battery, management 38
- boundaries
  - copying 51
  - linking to SmartMode layout 18
  - showing 10
- boundary line 18, 19
- boundary lines 18
- buoy reports 44

## C

- camera 46
  - configuration 45
  - controlling 45, 46
  - home position 45
  - pausing 45
  - standby 45
- celestial information 38, 39
- chart
  - layers 10, 11
  - settings 10, 11
- charts 6, 8, 10–12
  - appearance 10, 11

- details 7
  - fishing 6
  - layers 10, 11
  - measuring distance 7
  - navigation 6–8
  - quickdraw 11–13
  - radar 11
  - settings 10
  - symbols 7
  - updating 5
- circuits 52
  - clock 49
    - alarm 49
  - collision alarm 9, 50
  - color mode 3
  - combinations 3
  - compass
    - data bar 3
    - rose 10
  - courses 13
  - current stations 38, 39
    - indicators 8

## D

- DAB 40
- data
  - backup 51
  - copying 51
  - management 51
- deleting, all user data 19
- depth log 38
- depth shading 10, 11, 13
- destinations
  - navigation chart 14
  - selecting 14
- device
  - cleaning 53
  - keys 7
  - registration 52
- digital selective calling 35, 36
  - channels 36
  - contacts 35
  - individual routine call 36
  - turning on 35, 50
- digital switching 52
- distress call 35, 36
- distress signal device 9
- DSC. See digital selective calling

## E

- EBL 31
  - adjusting 31
  - measuring 31
  - showing 31
- EGNOS 47
- engine gauges 37
  - configuring 37
  - status alarms 37
- EPIRB 9
- event log 47

## F

- factory settings 51
  - stations 3
- favorites 2
- Fish Eye 3D
  - sonar cone 11
  - suspended targets 11
  - tracks 11
- fishfinder. See sonar
- fishing chart 6, 44
- FM 40
- fuel capacity 37
- fuel gauges 37
  - status alarm 37, 49
  - synchronizing with actual fuel 37

## G

- gain, sonar 24
- Garmin ClearVü 21
- Garmin Marine Network 19, 49

- Garmin product support. See product support
- gauges 37
  - engine 37
  - fuel 37
  - limits 37
  - status alarms 37
  - trip 38
  - wind 37, 38
- GLONASS 47
- Go To 14, 15
- GPS 53
  - EGNOS 47
  - GLONASS 47
  - signals 2
  - source 2
  - WAAS 47
- GPS accuracy 49
- graphs
  - air temperature 38
  - atmospheric pressure 38
  - configuring 38
  - depth 38
  - water temperature 38
  - wind angle 38
  - wind speed 38
- GRID 53
- GRID pairing 47, 53
- gybing. See tacking and gybing

## H

- heading 34
  - adjusting 34
  - heading hold 20
  - holding 34
  - line 10, 21
  - Shadow Drive 34
- help. See product support
- home screen 2
  - customizing 2, 3

## I

- images 4, 53

## J

- jibing. See tacking and gybing
- joystick 53

## K

- keel offset 20, 49
- keyboard 47

## L

- language 46, 47

## M

- man overboard 14, 35, 36
- manual viewer 1
- maps. See charts
- marine services 14
- mark location 14
- MARPA
  - navigation chart 11
  - tagged object 31
  - targeting 30
  - threats 9, 31
- measuring distance 22
  - charts 7
- media player 39–41
  - alphabetical search 39
  - DAB 40
  - device name 41
  - FUSION-Link 39
  - muting 39
  - preset 40, 44, 45
  - radio 41
  - repeating 39
  - shuffling 39
  - SiriusXM Satellite Radio 41
  - source 39
  - tuner region 40
  - tuning mode 40



- VHF **40**
- zones **39**
- memory card **51, 52**
  - detailed maps **51**
  - installing **1**
- MOB, device **9**
- music player **39, 41, 42**. See media player

## N

- nav aids **7**
- navigation alarms **49**
- navigation chart **6, 8, 14, 44**
  - marine service points **14**
  - MARPA **11**
  - radar overlay **29**
  - vessel trails **11, 36**
- navigation inset **3**
- networking. See Marine Network
- NMEA 0183 **35, 48**
- NMEA 2000 **35, 49**
- notifications **4**

## O

- off **4**
- off course alarm **49**
- offset, front of boat **33**
- other vessels
  - AIS **11**
  - trails **11**
- overlay numbers **3**

## P

- Perspective 3D **44**
- photos, aerial **8**
- position, tracking **36**
- position report **36**
- power key **1, 4**
- powerboat **3, 19**
- preferred data source **33**
- premium charts **7, 8**
  - aerial photos **8**
  - Fish Eye 3D **11**
  - tide and current indicators **8**
- presets **3, 40**
  - DAB **40**
- product registration **52**
- product support **1, 54**

## Q

- quickdraw **12, 13**
  - settings **13**

## R

- radar **29–31, 33**
  - AIS **31**
  - bird mode **31**
  - clutter **32**
  - color scheme **33**
  - custom park position **33**
  - echo trails **31**
  - field of view **33**
  - front-of-boat offset **33**
  - gain **31, 32**
  - guard zone **30**
  - MARPA **9**
  - optimizing display **32**
  - overlay **11**
  - overlay screen **29**
  - range **30**
  - range rings **33**
  - source **33**
  - timed transmit **29**
  - transmitting **29**
  - waypoints **33**
- radar overlay **29**
- radio **40**
  - AM **40**
  - FM **40**
  - SiriusXM **41**
- range, sonar **24**
- range rings **10**

- registering the device **52**
- remote control **5**
  - disconnecting **5**
- resetting
  - settings **41**
  - station layouts **3**
- Route To **13, 14**
- routes **14, 18**
  - copying **51**
  - creating **15**
  - deleting **16**
  - editing **15**
  - navigating **15**
  - navigating parallel to **16**
  - synchronizing **19**
  - viewing list of **15**
  - waypoints **51**

## S

- safe depth **47**
- safe height **47**
- safe-zone collision alarm **9, 50**
- sailboat **3, 19**
- sailing **10, 19**
  - race timer **19**
  - starting line **19**
- sailing gauges **37**
- sailing starting line **19**
- SART **9**
- satellite imagery **8**
- satellite signals, acquiring **2**
- screen, brightness **3**
- screenshots **53**
  - capturing **53**
- settings **13, 46, 47**
  - radar display **33**
  - system information **47**
- Shadow Drive, enabling **34**
- sharing data **51**
- shoreline distance **17, 48**
- shortcuts **3**
- SideVü **22**
- SiriusXM **40, 42**
  - Satellite Radio **41**
- SiriusXM Satellite Radio **40, 41**
- smart notifications **4**
- SmartMode layout, linking to boundary **18**
- software
  - updates **41, 52**
  - updating **5, 52**
- sonar **21, 23, 26**
  - a-scope **25, 27**
  - alarms **26, 49**
  - appearance **25**
  - bottom lock **25**
  - color gain **24**
  - color rejection **25**
  - cone **11**
  - depth **25**
  - depth scale **25**
  - frequencies **26, 27**
  - FrontVü **23**
  - gain **24**
  - Garmin ClearVü **21**
  - interference **25**
  - measuring distances **22**
  - noise **24**
  - numbers **3**
  - Panoptix **22, 23, 27, 28**
  - range **24**
  - recording **24**
  - scroll speed **25**
  - sharing **24**
  - SideVü **22**
  - source **24**
  - surface noise **25**
  - suspended targets **25**
  - views **21**
  - waypoint **23**
  - whiteline **25**

- zoom **25**
- SOS **14, 36**
- stations **2**
  - changing the station **47**
  - customizing the home screen of **2**
  - ordering the displays **47**
  - restoring the layout **3, 47**
- support. See product support
- suspended targets **11**
- symbols **8**
- synchronizing, user data **19**
- system information **47, 52**

## T

- tacking and gybing **20, 21**
  - heading hold **20**
  - wind hold **20**
- targeting **30**
- temperature log **38**
- tide stations **8, 38, 39**
  - indicators **8**
- tracks **17, 18**
  - clearing **18**
  - copying **51**
  - deleting **18**
  - editing **17**
  - list **17**
  - navigating **18**
  - recording **18**
  - saving **17**
  - saving as route **17**
  - showing **10, 17**
- transducer **21, 23, 26, 28**
- trip gauges **38**
- troubleshooting **53**

## U

- unit ID **47**
- units of measure **47**
- updates, software **52**
- updating
  - charts **5**
  - software **5**
- user data
  - deleting **19**
  - synchronizing **19**

## V

- vessel trails **11, 36**
- VHF radio **35**
  - calling an AIS target **36**
  - distress calls **35, 36**
  - DSC channel **36**
  - individual routine call **36**
- video **44–46**
  - configuring **44, 45**
  - source **44, 45**
  - viewing **44, 45**
- VIRB camera **46**
- voltage **49**
- VRM **31**
  - adjusting **31**
  - measuring **31**
  - showing **31**

## W

- WAAS **47**
- warning manager **39**
  - messages **39**
- water
  - speed **50**
  - temperature log **38**
  - temperature offset **50**
- waypoints **14, 53**
  - copying **51**
  - creating **7, 14**
  - deleting **15**
  - editing **14**
  - man overboard **14**
  - navigating to **14**
  - showing **10**

- sonar [23](#)
- synchronizing [19](#)
- tracked vessel [36](#)
- viewing list of [14](#)
- weather [42](#)
  - alarms [49](#)
  - broadcasts [42](#)
  - charts [11](#), [42](#), [44](#)
  - fishing [43](#)
  - fishing chart [44](#)
  - forecast [42–44](#)
  - navigation chart [44](#)
  - overlay [44](#)
  - precipitation [42](#)
  - sea conditions [43](#)
  - subscription [41](#), [44](#)
  - surface pressure [43](#)
  - visibility [43](#), [44](#)
  - water temperature [43](#)
  - wave information [43](#)
  - winds [43](#)
- Wi-Fi [4](#)
- Wi-Fi technology [5](#)
- wind, rose [10](#)
- wind angle graph [38](#)
- wind gauges [37](#), [38](#)
- wind hold [20](#)
  - adjusting [20](#)
- wind sensor [6](#)
- wind speed graph [38](#)
- wireless devices [5](#), [6](#), [45](#), [46](#)
  - connecting a wireless device [5](#), [6](#)
  - connecting to a wireless device [4](#)
  - network configuration [5](#)

**Z**

- zoom, sonar [25](#)



