



SERIES VRG330



Mtrl.nr: 9814 03 04 • Ritn.nr: 7049 utg. C • Rev. 1605



Series VRG331
Series VRG332
Series VRG333
Series VRG338

CE
PED 2014/68/EU, article 4.3

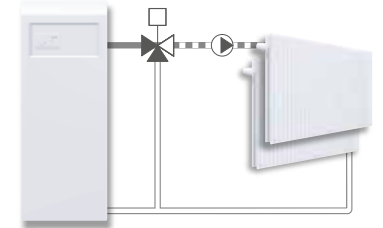
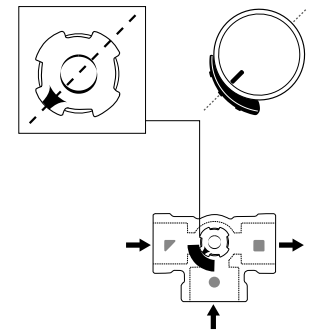
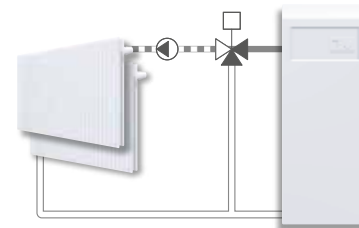
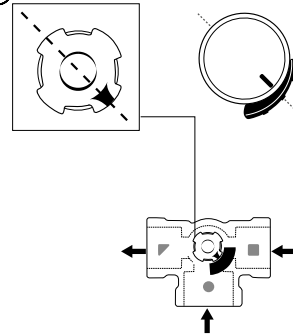
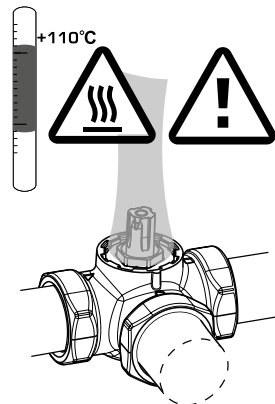
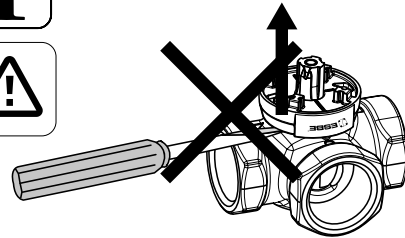
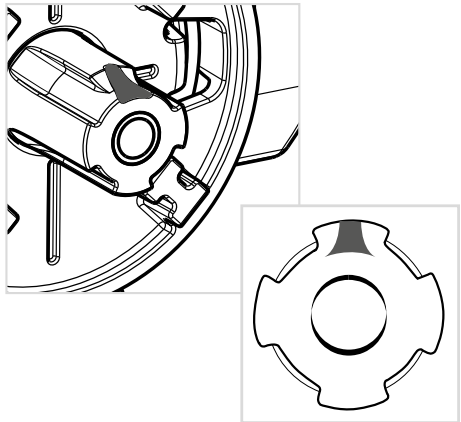
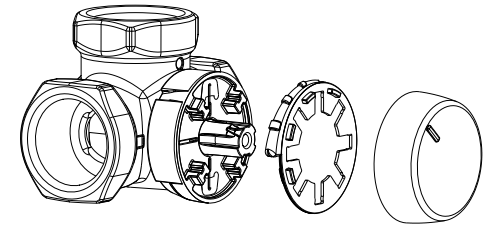
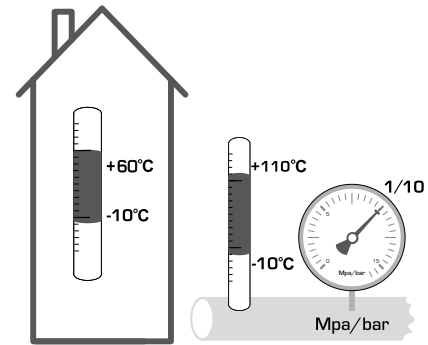

Piping Schematics are General Representations

2

a

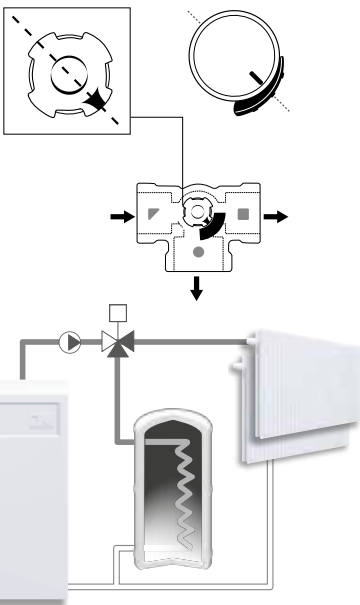

b

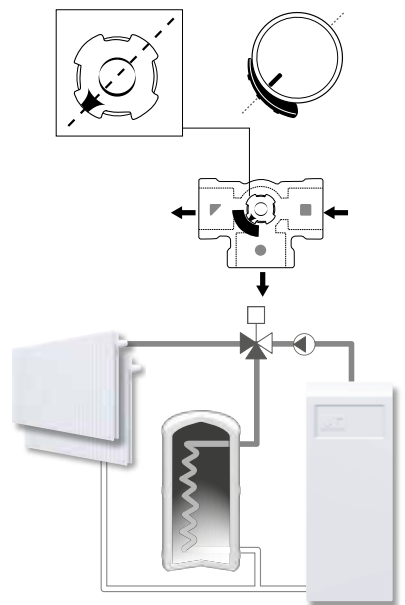

i



<http://www.esbe.eu/global/en/products/rotary-valves>