

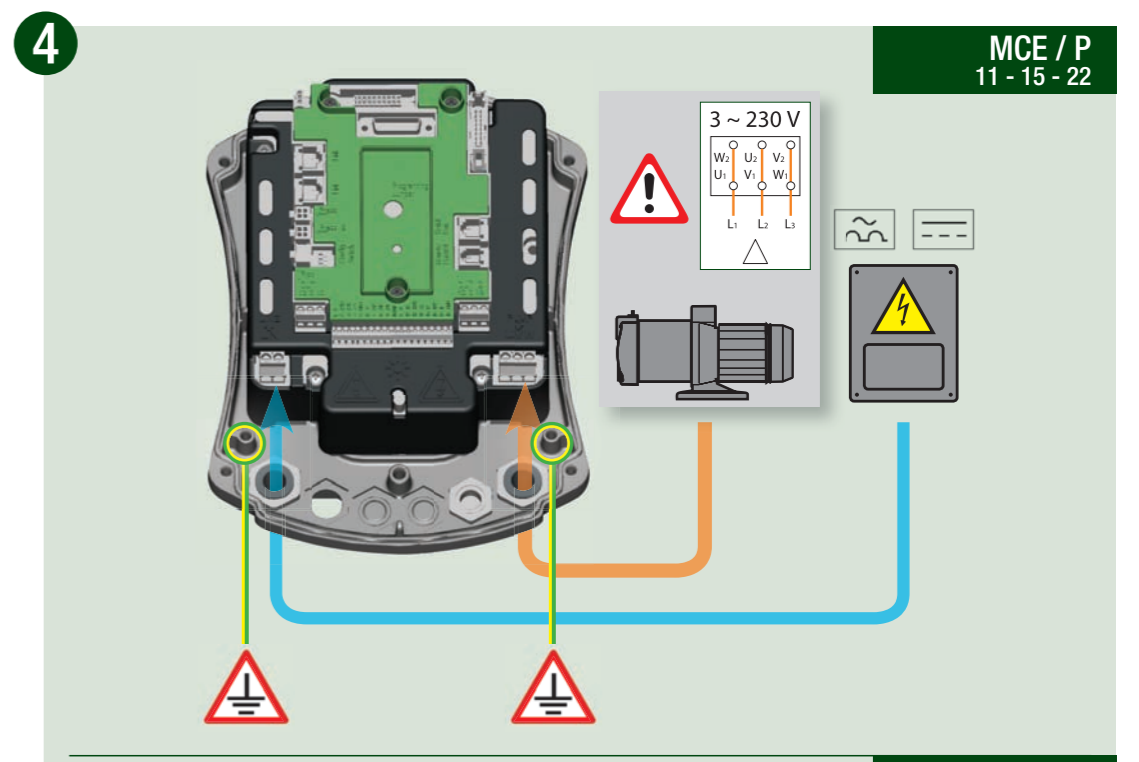

1 QUICK GUIDE INVERTERS MCE / P

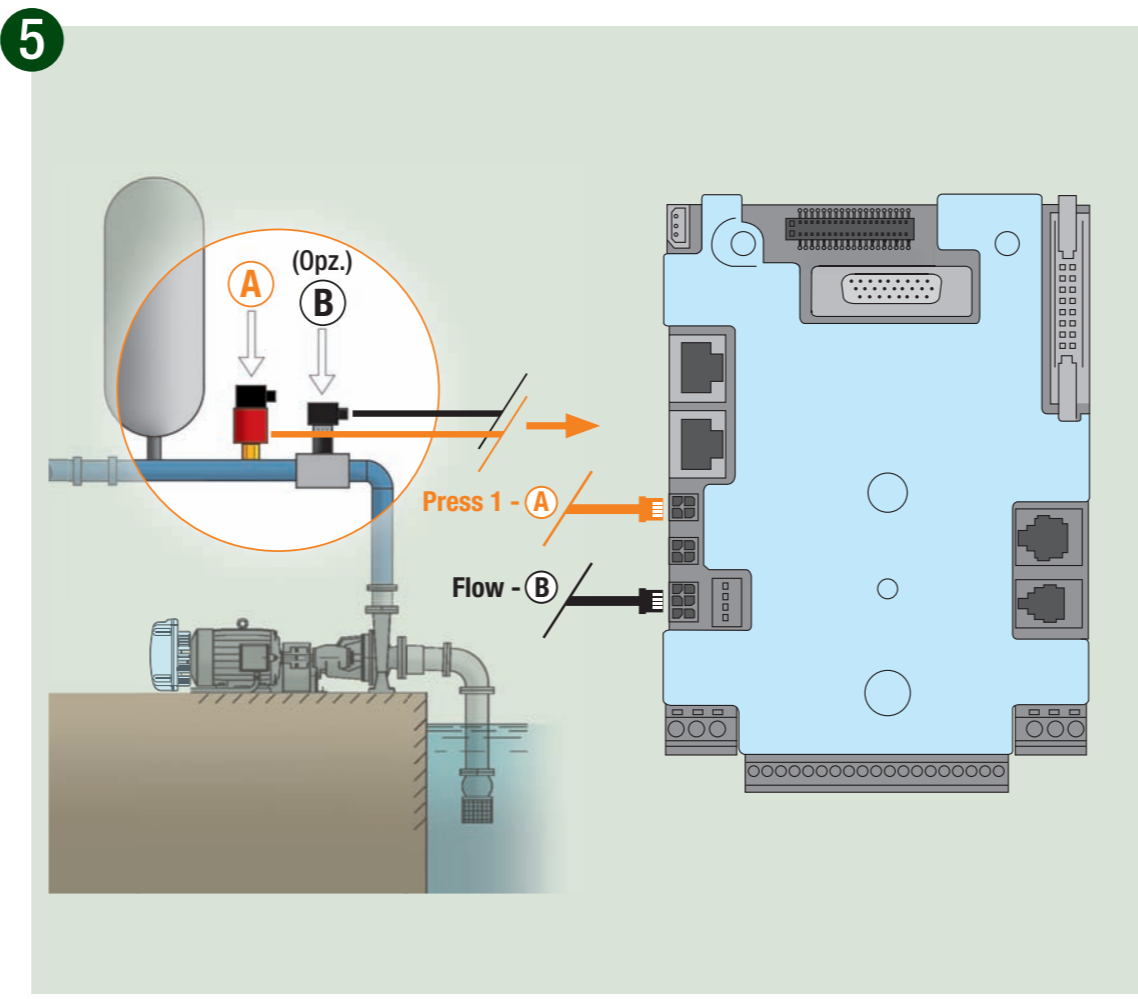

MCE / P
11 - 15 - 22

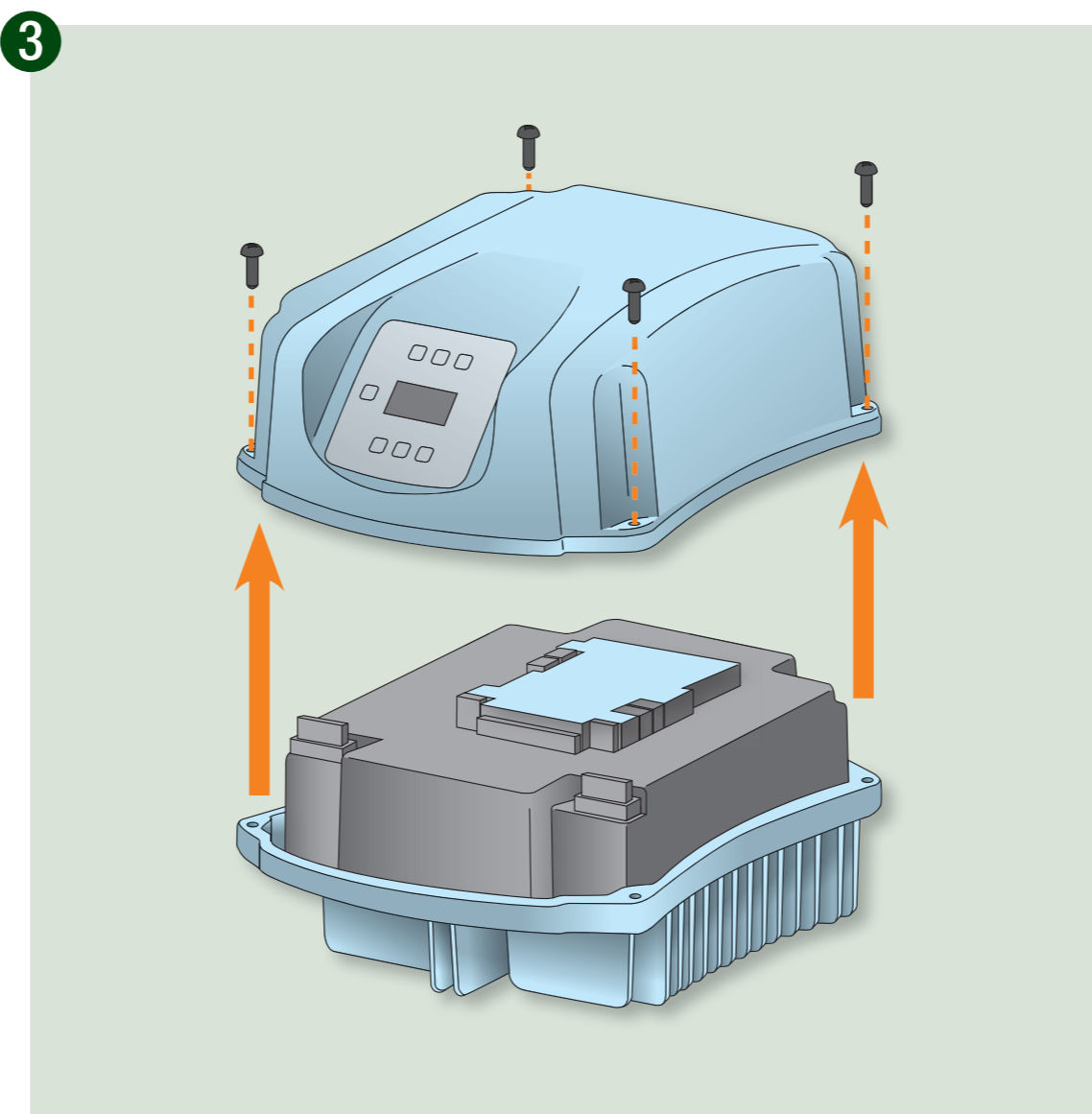
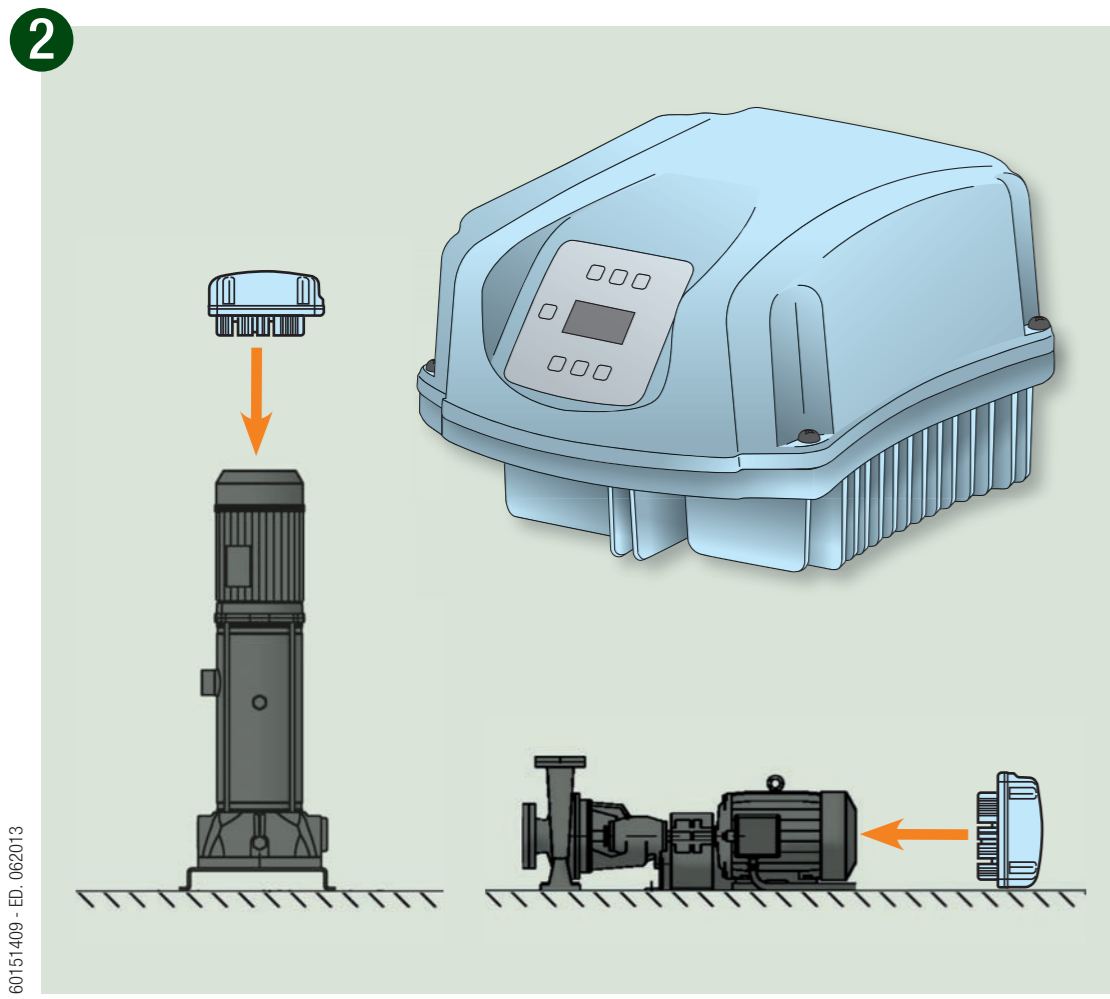
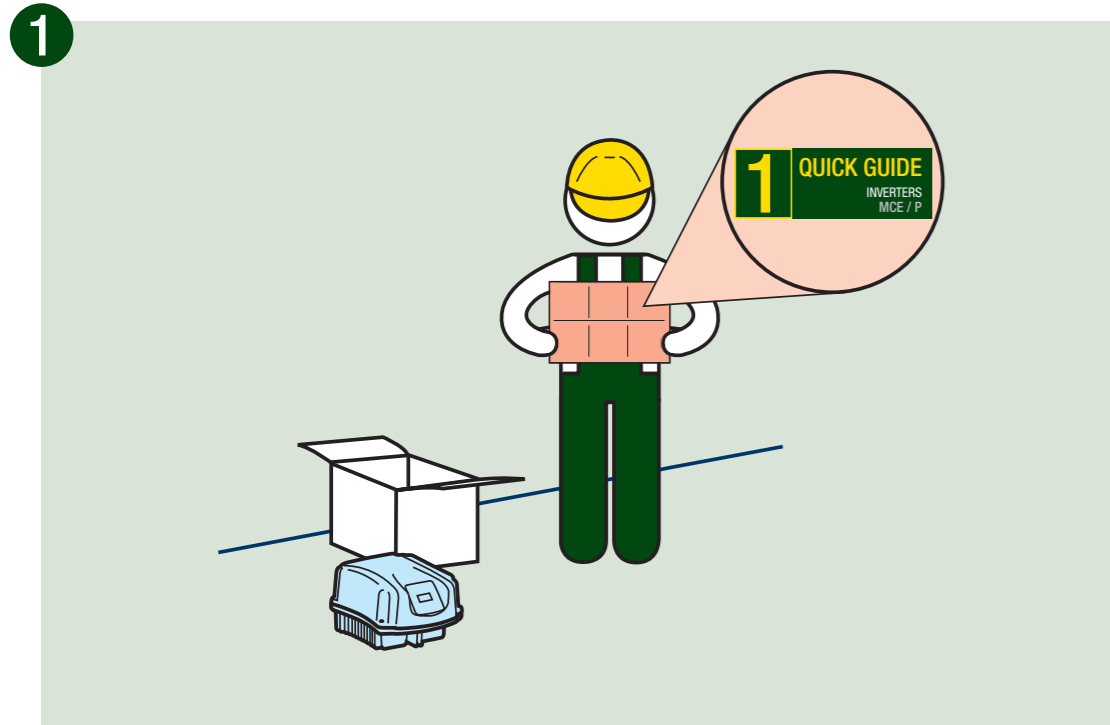
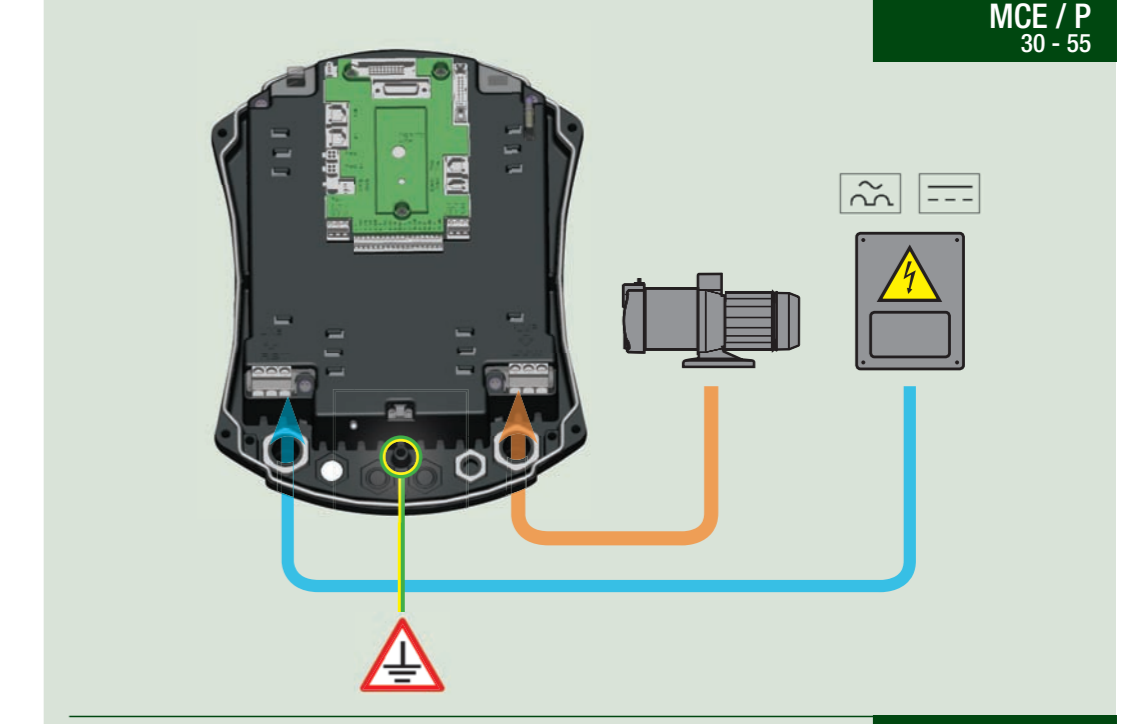

MCE / P
30 - 55

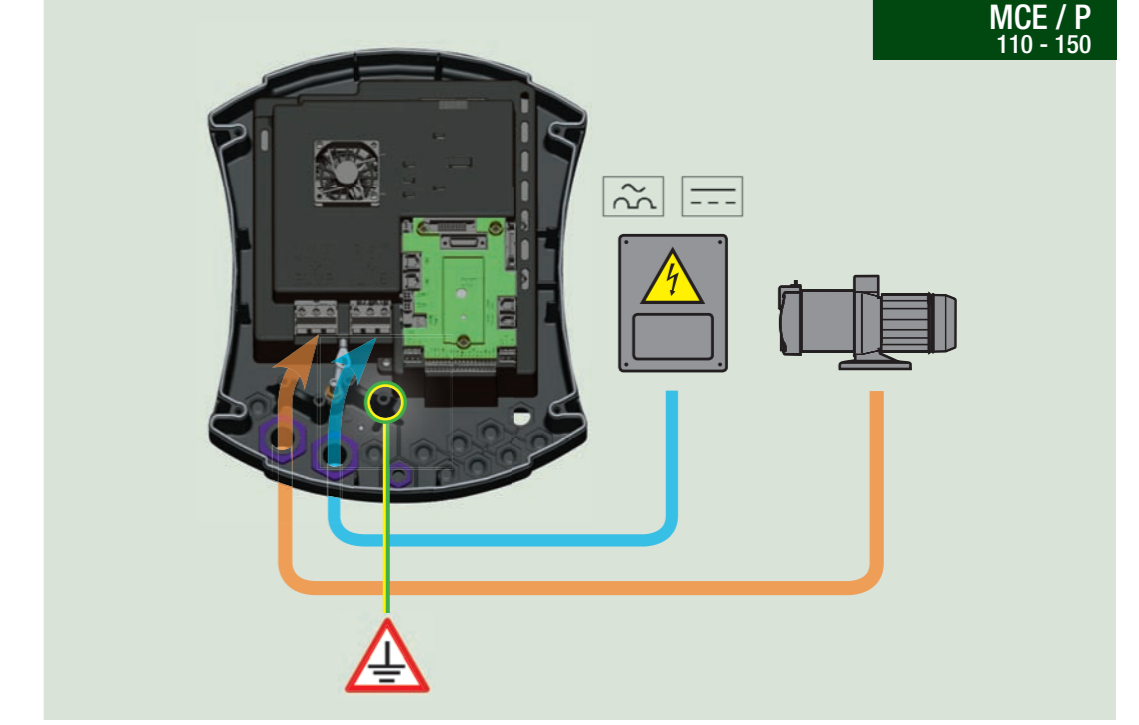

MCE / P
110 - 150

6

5"

MODE 300W + SET + - = RC

INSTALLER MENU
Nominal current
22,0 A_{rms}
SB 0,0 Hz 3,1 bar

MCE / P
11 - 15 - 22

MCE / P
30 - 55

MCE / P
110 - 150

7

MODE 300W = RT

INSTALLER MENU
Rotating direction
W V U
1
SB 0,0 Hz 3,1 bar

MCE / P

1 QUICK GUIDE
INVERTERS
MCE / P

1

Ok

8

A + B

MODE 300W x 7 = FI

INSTALLER MENU
Flow sensor
No sensor
1
SB 0,0 Hz 3,1 bar

FL = 1

MODE 300W x 1 = FD

INSTALLER MENU
Pipe diam
2"

7

9

Boostersets

2 QUICK GUIDE
INVERTERS
Pumpsets

2

9

SET =

MAIN MENU
FREQ: 0,0 Hz
PRESS: 3,1 bar
STATE: SB

3"

MODE 300W + SET = SP

SETPOINT MENU
Setpoint pressure
3,0 bar
SB 0,0 Hz 3,1 bar



DAB PUMPS S.p.A.
Via Marco Polo, 14 - 35035 Mestrino (PD) Italy
Phone +39.049.5125000 - Fax +39.049.5125950
customer.service@dwtgroup.com
www.dabpumps.com